



POWERSPORTS OWNER'S MANUAL

Always wear a helmet it could save your life!
This Go-kart is designed for operators age 13 and
over. Adult supervision is required for riders age
16 and under



Model: SK100

READ THIS MANUAL CAREFULLY!

Provincial / Municipal governments have different regulations pertaining to owning and operating an off-road vehicle, learn the regulations in your area.

www.colemanpowered.com

REV052819

To the Owner

Congratulations on your purchase of a Coleman Powersports Go Kart. This Owner's/Operator's manual will provide you information regarding safe operation, operational instructions, maintenance and care. Fully understanding this manual and following all of the instructions herein will provide the knowledge needed to have safe and enjoyable Go Kart operation.

For questions regarding operation and maintenance of this Go Kart, please call Coleman Powersports toll free 888-405-8725

Safety - Notice to parents

The recommended age for operating this Go Kart is 13 and over. Even though a child may meet the minimum recommended age, children differ in skills, physical abilities, and judgement. Some children may not be able to operate the Go Kart safely. Parents should permit continued use only if they determine that the child has the ability to operate the Go Kart in a safe manner.

THIS Go Kart IS NOT A TOY AND COULD BE HAZARDOUS TO OPERATE. A Go Kart handles differently from other vehicles including motorcycles and cars. A collision or rollover can occur quickly, even during routine maneuvers such as turning, driving on hills and over obstacles.

Reading the Owner's/ Operator's Manual

It is important this manual is read from cover to cover carefully by the Go Kart owner and all operators. Parents should review the manual carefully with their children. Never allow anyone to operate the Go Kart without first reading and understanding the Owner's/Operator's manual.

This Owner's/ Operator's manual should be a permanent part of the Go Kart and should remain with the vehicle at all times. The manual should also remain with the vehicle if sold.

To emphasize special important information in the manual, please note the following :



This is the alert symbol. The symbol means **ATTENTION!**, **BECOME ALERT!**

To emphasize important safety information, the word **WARNING**, with the alert symbol, has special meaning:



WARNING

Indicates a potential hazard that could result in **SEVERE INJURY** or **DEATH** to the operator, bystander or person repairing the go-kart.

To emphasize important information, the word **CAUTION** has special meaning:

CAUTION:

Indicates special precautions that must be taken to avoid damage to the Go Kart.

To emphasize important information, the word **NOTE** has special meaning:

NOTE:

Indicates key information to make procedures easier or clearer to understand.



WARNING or CAUTION

The first part will identify a **POTENTIAL HAZARD**.

The second part will describe **WHAT COULD HAPPEN** if the warning or caution is ignored.

The third part will describe **HOW TO AVOID THE HAZARD**.

Coleman Powersports is concerned about the environment and believes in conserving and protecting all natural resources. For this reason, owners should recycle, trade in, or dispose as appropriate, oil and tires.

This manual is based on the latest product information available at the time of publication. Coleman Powersports has a policy of continually improving its products. Due to improvements, or other changes, there may be some discrepancies. We reserve the right to make product changes at any time, without notice and without incurring any obligation to make the same or similar changes to vehicles previously built or sold.

WARNING

Operating, servicing and maintaining a passenger vehicle or off-road vehicle can expose you to chemicals including engine exhaust, carbon monoxide, phthalates, and lead, which are known to the state of California to cause cancer and birth defects or other reproductive harm. To minimize exposure, avoid breathing exhaust, do not idle the engine except as necessary, service your vehicle in a well-ventilated area and wear gloves or wash your hands frequently when servicing your vehicle. For more information go to www.P65Warnings.ca.gov/-passenger-vehicle

TABLE OF CONTENTS

COLEMAN POWERSPORTS WARRANTY.....	1	ENGINE OIL	26
IMPORTANT SAFETY LABELS.....	3	CHECKING.....	26
LOCATION.....	3	CHANGING.....	26
LABELS.....	4	FUEL HOSE INSPECTION.....	27
SAFETY	5	BRAKES.....	27
DESCRIPTION AND PART LOCATIONS...	6	BRAKE FLUID INSPECTION....	27
DESCRIPTION AND PART FUNCTIONS..	7	CLUTCH CLEANING AND	
IGNITION SWITCH.....	7	LUBRICATION.....	28
BRAKE PEDAL.....	7	CHAIN.....	29
GAS PEDAL.....	7	INSPECTION.....	29
SPEED LIMITER BOLT.....	7	TENSION AND ADJUSTMENT....	29
FUEL TANK CAP.....	8	CLEANING AND LUBRICATION..	29
OIL FILL PLUG/DIPSTICK.....	8	TIRES.....	30
SEAT ADJUSTMENT.....	9	REPLACING.....	30
FUEL AND OIL.....	10	STORAGE.....	31
FUEL.....	10	RETURNING TO SERVICE.....	31
ENGINE OIL.....	10	WASHING THE GO KART.....	32
PRE RIDE INSPECTION.....	11	TRANSPORTING.....	32
OPERATING THE GO KART.....	12	TROUBLE SHOOTING.....	33
WARNINGS.....	12	TORQUE SPECIFICATIONS.....	34
HELMET, EYE PROTECTION AND		SPECIFICATIONS.....	35
PROTECTIVE CLOTHING.....	13	VEHICLE AND ENGINE NUMBER	
SEAT BELTS.....	14	LOCATION.....	36
STARTING THE ENGINE.....	15	EMISSION CONTROL SYSTEM	
STARTING OFF.....	16	WARRANTY.....	37
OPERATING ON HILLS.....	17		
CLIMBING A HILL.....	17		
DESCENDING A HILL.....	17		
TRAVERSING A HILL.....	17		
SKIDDING OR SLIDING.....	18		
OPERATING THROUGH WATER.....	19		
OPERATING IN COLD WEATHER.....	20		
LOAD GUIDELINES.....	21		
AFTER MARKET PARTS.....	21		
MAINTENANCE.....	22		
MAINTENANCE CHART.....	23		
AIR FILTER.....	24		
SPARK PLUG.....	25		

COLEMAN POWERSPORTS LIMITED WARRANTY

This Warranty is NOT the Emissions Control Warranty. Please note this is a general Limited Warranty for this product. It IS NOT an Emissions Control Warranty. Please see the Emissions Control Warranty in this manual for warranties covering Emission components. The Emissions Control Warranty can be found on page 38.

The Warranty

Coleman Powersports offers the following warranty to the initial purchaser of this new Coleman Powersports product. The initial purchaser is defined as the first person to purchase a new Coleman Powersports product from an Authorized Retailer of Coleman Powersports products.

The limited warranty period for this product is 90 days from the date of purchase shown on the original sales receipt.

What is a Defect?

The Product is warranted to be free from manufacturing defects in material and workmanship for a period of 90 days from the date of purchase shown on the sales receipt. During this period of time Coleman Powersports will, at its option, either repair, replace or refund the purchase amount of any original Coleman Powersports unit/part which is covered by this warranty and is proven to be defective in workmanship or material.

To qualify for this warranty the part:

1. Must have been purchase from Coleman Powersports or from an authorized Coleman Powersports Retailer.
2. This warranty does not apply to any vehicle which is used in competition or used in a manner not consistent with the normal and proper intended use for the vehicle. This vehicle is not intended for rental or commercial use.

Who Can Perform Repairs Under this Warranty?

Repairs under this warranty should be performed by an authorized Coleman Powersports retailer or comparable service center.

How to get service under this warranty

To get warranty service call Coleman Powersports at 888-405-8725 for the location of your local service center. Please do not return the product to the retailer where the product was purchased unless instructed to do so by Coleman Powersports. The retailer of this product does not make any warranty of its own and has no authority to implement this warranty on behalf of Coleman Powersports without the approval of Coleman Powersports. A COPY OF YOUR SALES RECEIPT IS REQUIRED FOR WARRANTY SERVICE.

What this Warranty Does Not Cover

This warranty does not cover the following

1. Damage due to lack or improper maintenance as described in this manual.
2. Damage which is caused by normal use and not caused by a defect in materials or workmanship.
3. Use of the product which is not consistent with the intended use as described in the operating instructions.
4. Any expendable maintenance item which need replacement or service as part of normal maintenance, unless such items have defects in material or workmanship which cause failure or premature wear.
5. Any product which has been altered or modified in a manner not consistent with the original design of the product or in a manner not approved by Coleman Powersports.
6. Tires
7. Damage or failures due to abuse, neglect, or misuse of the product.

Limitations of this Warranty

This warranty does not cover and Coleman Powersports disclaims any responsibility for:

1. Loss of time or loss of use of the product.
2. Transportation costs to and from the authorized center.
3. Other loss or damage to other equipment or personal items.

Length of Implied Warranties

Any implied warranties are limited to the duration set forth in this warranty. Coleman Powersports does not make any claim as to the merchantability or fitness for a particular purpose which would extend longer than the duration of this written warranty.

Check you State Laws as some State Laws do not allow limitations as to the duration of an implied warranty. Some States may also not allow limitation or exclusions based on incidental or consequential damages.

IMPORTANT LABELS

LOCATION

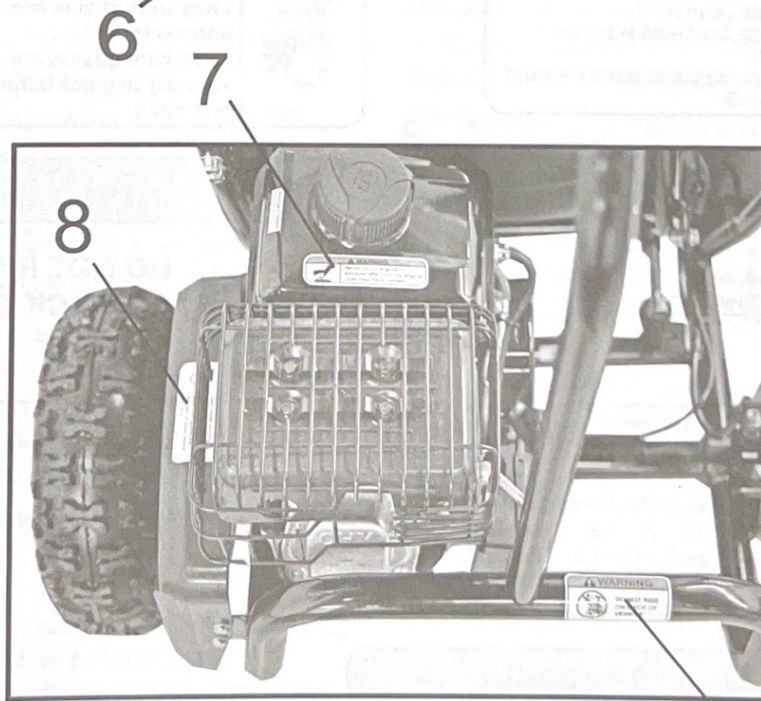
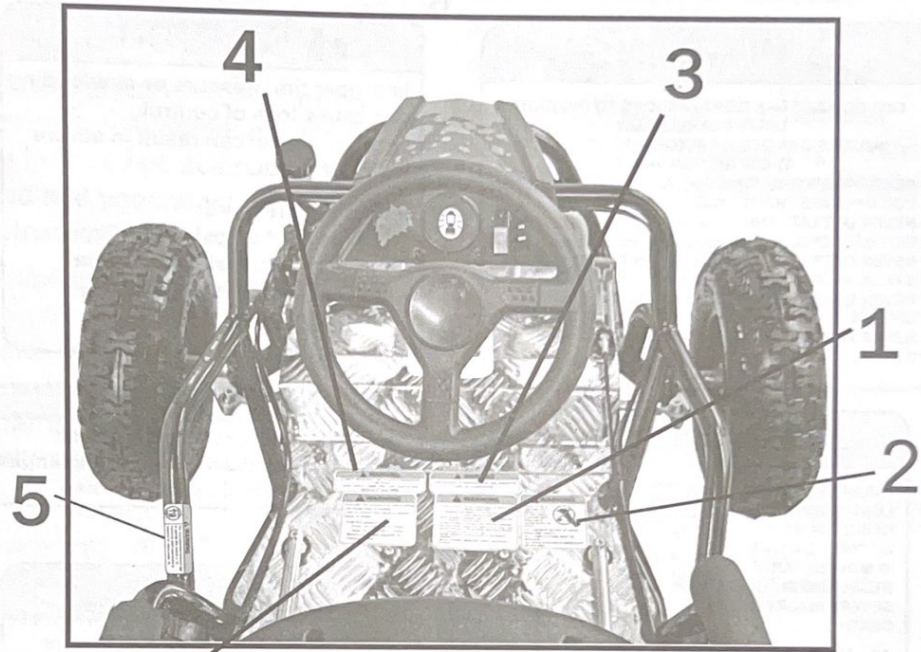

IMPORTANT LABELS

1 WARNING LABELS

1

! WARNING

THIS GO-KART CAN BE HAZARDOUS TO OPERATE IF DRIVEN CARELESSLY. INJURIES CAN RESULT IF YOU DO NOT FOLLOW THESE INSTRUCTIONS:

- READ OWNER'S MANUAL AND ALL LABELS BEFORE YOU OPERATE THIS GO-KART.
- NEVER OPERATE THIS GO-KART WITHOUT PROPER INSTRUCTIONS. Beginners require mature supervision.
- NEVER OPERATE THIS GO-KART ON PUBLIC ROADS. It is intended for off-road use only.
- NEVER OPERATE THIS GO-KART AT EXCESSIVE SPEEDS.
- NEVER ATTEMPT WHEELIES, JUMPS, OR OTHER STUNTS.

6

! WARNING

Improper tire pressure or overloading can cause loss of control. Loss of control can result in severe injury or death.

- Cold tire pressure:
Front: 14 ± 1 psi (96.5 ± 7 kpa)
Rear: 14 ± 1 psi (96.5 ± 7 kpa)
- Maximum weight capacity is 150 lbs. (68 kg)

2

! WARNING

FAILING TO TIE UP LONG HAIR COULD RESULT IN HAIR GETTING CAUGHT IN MOVING PARTS RESULTING IN SEVERE INJURY OR DEATH



ALL HAIR MUST BE TIED UP ABOVE SHOULDER LENGTH.
ALL LOOSE CLOTHING MUST BE SECURED.
ALL NECKLACES AND SCARVES MUST BE SECURED

7

! WARNING



Never touch engine or exhaust after running engine until they have cooled.

8

! WARNING



Keep hands and fingers away from chains and sprockets. Make sure guards are securely in place before operation.

3

! WARNING

ALWAYS WEAR SEAT BELT WHILE OPERATING THIS VEHICLE. KEEP HANDS, ARMS, FEET AND LEGS IN THE VEHICLE AT ALL TIMES.

9

! WARNING



DO NOT RIDE ON BACK OF VEHICLE

4

! WARNING



The recommended minimum age to operate this vehicle is 13. Continual adult supervision is required for riders under 16.

5

! WARNING

THIS GO-KART IS DESIGNED FOR ONE OPERATOR AND NO PASSENGERS.

SAFETY

1. Always read and understand the Owner's/Operator's manual and warnings before starting the Go Kart for the first time
2. This Go Kart should only be assembled by someone who has the knowledge, ability and skills to read and understand mechanical instructions.
3. Use caution when providing maintenance on this Go Kart. Make sure engine is turned off and all components are cool. Never attempt to make any adjustments while engine is running.
4. Do not modify this Go Kart in any way, modifications could make the Go-Kart unsafe and/or in violation of Federal and State laws.
5. This Go Kart is recommended for riders 13 and older.
6. Always wear a certified DOT motorcycle or ATV helmet that fits properly.
7. This Go Kart is designed for one operator and no passengers.
8. Always wear seat belt provided. Make sure seat belts fit properly before starting the Go Kart.
9. Never operate this Go Kart on paved surfaces and/or public roads. Pavement may cause the Go Kart to become unstable.
10. The head bar in back of the operator is not intended to provide rollover protection. Before each use, make sure all tubes are securely in place and bolts are tight.
11. Never operate Go Kart with long hair, loose jewelry or loose clothing that could get caught in moving parts.
12. Always go slow on unfamiliar terrain. Be alert to changing terrain conditions when operating the Go Kart.
13. Never take drugs or alcohol before or during operation of this Go Kart.
14. Never attempt jumps or any other type of stunts while operating this Go Kart.
15. Always follow the pre-ride inspection procedures and maintenance procedures located in this manual before use.
16. Always go slow on terrain that is not familiar, be alert, an obstacle could come up unexpectedly.
17. Always keep hands, arms, legs and feet inside the Go Kart at all times.
18. Never operate Go Kart in water that is deeper than 2 inches. Do not operate in fast flowing water. Water can affect braking performance of the Go Kart. Check braking performance after exposure to water, it may be necessary to apply the brakes allowing friction to dry out the pads.
19. Do not attempt to fill the Go-Kart with gasoline while the engine is running or the engine is hot.

DESCRIPTIONS AND PART LOCATIONS

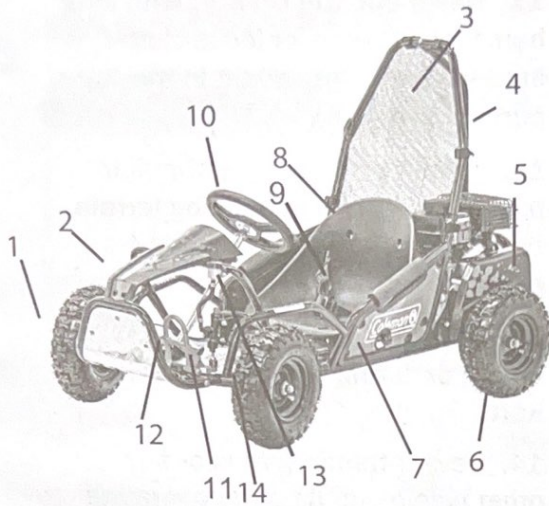

1. Front tires
2. Plastic nose piece
3. Net
4. Head bracket assembly
5. Clutch assembly cover
6. Rear tires
7. Side panel
8. Seat
9. Seat belt
10. Steering wheel
11. Gas pedal
12. Brake pedal
13. Brake fluid reservoir
14. Tie rods
16. Rear brake caliper
17. Rear axle
18. Drive chain
19. Fuel tank cap
20. Fuel tank
21. Pull start cord
22. Air filter housing
23. Muffler
24. Choke lever
25. Fuel Valve
26. Oil fill plug / Dipstick
27. Oil drain screw

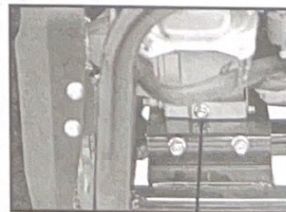
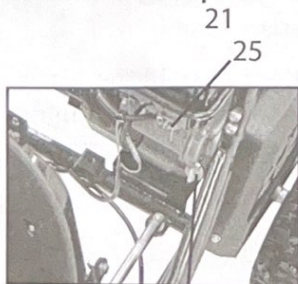
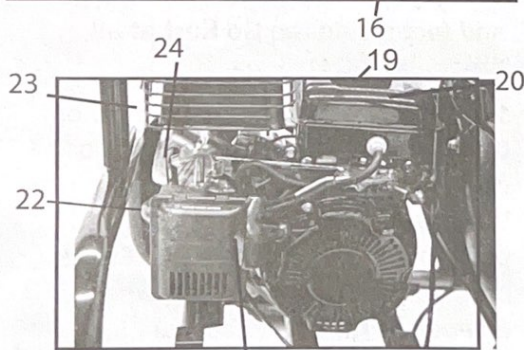
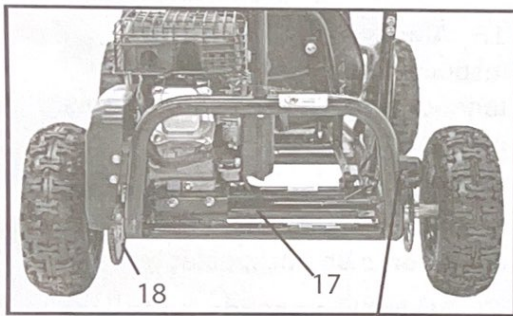

DESCRIPTION AND PART FUNCTIONS

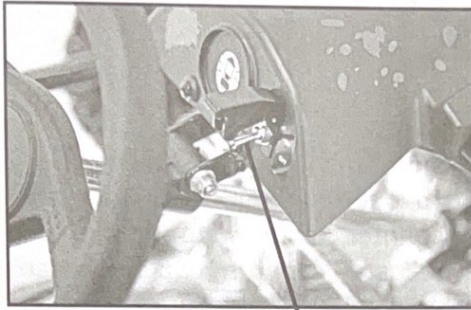

1

Ignition Switch (1): When the ignition switch is placed in the (ON) position the engine can start. When the ignition switch is placed in the (OFF) position the engine will not start, or will turn off, if running.



2

3

Brake Pedal (Red) (2): Depressing the brake pedal will stop the Go Kart. Note: Always check brakes before operation

Gas Pedal (Green) (3): Depressing gas pedal will increase engine RPMs causing Go Kart to move forward.

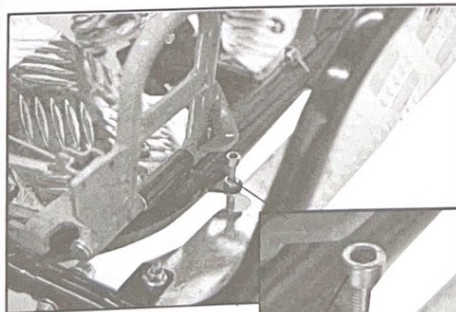

4

5

Speed limiter bolt/(4)
To limit the top speed, turn the throttle pedal speed regulator bolt (4) counter clockwise until the desired stop position is achieved. Re-tighten Jam nut (5) against the skid plate once adjustment is completed.

DESCRIPTION AND PART FUNCTIONS

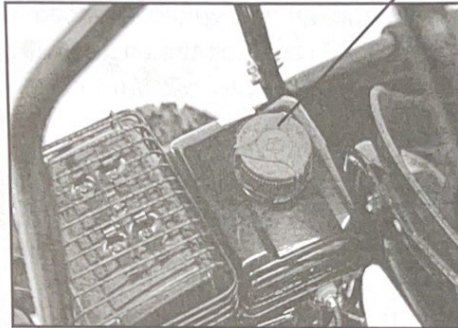

Fuel Tank Cap (1):

To open fuel tank cap, Turn cap counter clockwise to remove. To re-install cap, turn cap clockwise until snug. Make sure cap is seated properly .

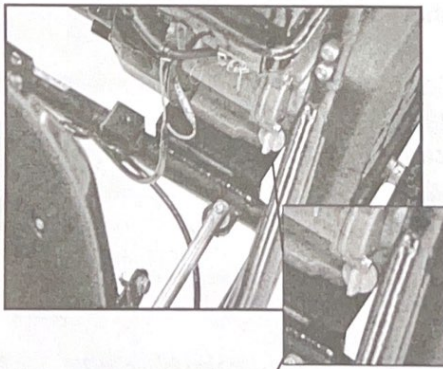

Oil Fill plug/Dipstick (2)

Move seat completely forward to gain access to the fill plug.
To open Oil fill plug/Dipstick, turn cap counter clockwise to remove.
To re-install cap, turn cap clockwise until snug. Make sure cap is seated properly

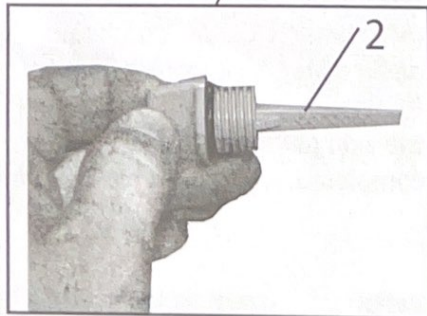

DESCRIPTION AND PART FUNCTIONS

SEAT ADJUSTMENT

1

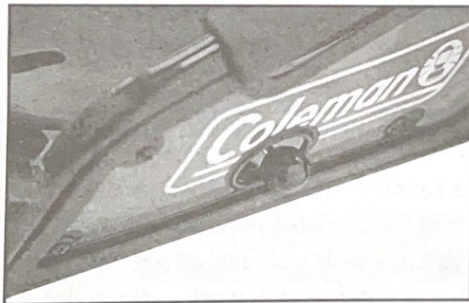

⚠ WARNING

Failure to have the seat locked in position could be hazardous.

The seat coming loose could cause the operator to lose control.

Never operate the Go Kart without the seat locked in place.

Seat adjustment (1)

The seat Lever is located on the left side of the go-kart. Pull out seat lever to move the seat forward or backward. Set seat location according to the size of the operator. Before operating the Go-Kart after seat adjustment, make sure the seat is locked in place and secure.

FUEL AND OIL

FUEL

Never use leaded gasoline in this product. Leaded fuel could affect the engine's emissions and damage the engine.

Go Kart requires clean unleaded regular gasoline with a minimum octane rating of 87 or higher.

Gasoline/ Ethanol blends

A blend of unleaded gasoline with Ethanol, also known as GASOHOL, at or below 10% (E10) can be used in your Go Kart. Ethanol greater than 10% can damage your engine and will void your warranty.

Gasoline/Methanol Blends

A blend of gasoline with Methanol of 5% or less can be used in your Go Kart. Do not use gasoline, under any circumstances, containing more than 5% Methanol, doing so will damage your engine and will void the warranty.

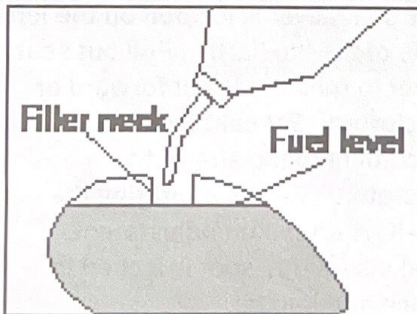

⚠ WARNING

Overfilling the fuel tank can cause the fuel to expand which can cause overflow due to the heat from the engine or sun. Spilled fuel can catch fire.

Never fill the fuel tank above the bottom edge of the filler neck.

⚠ WARNING

Fuel and fuel vapor are highly flammable and toxic. You can be burned or poisoned while refueling.

Before refueling make sure to follow the procedures listed:

- 1 Shut off engine, Make sure there are no flames, sparks or heat sources close by.
- 2 Make sure engine has cooled
- 3 Refuel only outdoors in a well ventilated area.
- 4 Do not smoke while refueling.
- 5 Wipe up any spills immediately.
- 6 Avoid breathing any fuel vapors.
- 7 Keep children and pets away.

ENGINE OIL

The recommended oil for this Go Kart is SAE10W-30 motor oil, if this oil is not available, any of the oils on the chart below will work. Note the temperature requirements for each of the oils.

Quantity of oil - .63qt. (.6L).

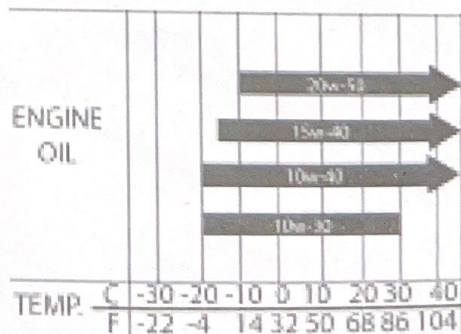

PRE-RIDE INSPECTION

Inspecting and checking the condition of the Go Kart before each ride is important. Following the pre-ride check list will help insure the you do not have mechanical problems which could result in injury or becoming stranded. Make sure the Go Kart is in good operating condition before each ride.

⚠ WARNING

Failing to inspect and maintain your Go Kart could be hazardous.

Not following the pre-ride inspection procedures could result in loosing control of the Go Kart resulting in an accident or damage to the Go Kart.

Always perform a Pre-ride inspection before operating.

⚠ WARNING

Performing maintenance and checks while the engine is running could be hazardous.

You could be severely injured by moving parts or hot surfaces.

Never perform maintenance or check procedures while the engine is running with the exception of checking the ignition switch or throttle.

WHAT TO CHECK	CHECK FOR
Steering	<ul style="list-style-type: none"> • Smoothness • No restriction of movement
Brakes	<ul style="list-style-type: none"> • Correct fluid level • Inspect hoses for leaks • Inspect brake pads for wear.
Tires	<ul style="list-style-type: none"> • Proper tire pressure • Proper tread depth • Rubber has no cracks
Fuel Tank	<ul style="list-style-type: none"> • Enough fuel for the ride • Fuel cap secure • Hoses have no signs of cracks or leaks
Throttle Pedal	<ul style="list-style-type: none"> • Pedal snaps back to idle when released • Operates freely
Engine Ignition switch	<ul style="list-style-type: none"> • Switch shuts off engine when activated.
Engine Oil	<ul style="list-style-type: none"> • Correct oil level
Drive Chain	<ul style="list-style-type: none"> • Proper tension • Lubricated • No excessive wear or damage
General Condition	<ul style="list-style-type: none"> • All nuts and bolts tight • No rattles from engine or frame while running

OPERATING THE GO KART

WARNING

Carrying a passenger on this Go Kart could be hazardous

Carrying a passenger could cause loss of control resulting in severe injury or death to the operator and/or passengers.

This Go Kart is designed for one operator and no passengers. Never allow a passenger on this Go Kart.

WARNING

Operating this Go Kart on paved surfaces could be hazardous.

Operating on paved surfaces, including parking lots, sidewalks, driveways and streets can cause loss of control resulting in severe injury or death. Go Kart tires are designed for off-road use only, paved surfaces adversely affect handling and control.

Avoid operating Go Kart on paved surfaces. If you must cross a paved surface, go slow and do not make sudden turns or stops.

WARNING

Operating this Go Kart in a irresponsible manner which includes jumping or other stunts could be hazardous.

Jumping or other stunts could result in loss of control of the Go Kart resulting in severe injury or death.

Never attempt stunts, such as jumping.

WARNING

Operating a Go Kart on hills could be hazardous.

Operating a Go Kart on a hill could result in rolling over while traversing, flipping over backwards while climbing, flipping over while descending, general loss of control of the Go Kart. Any of these accidents on a hill could result in severe injury or death.

Never operate a Go Kart on steep hills.

WARNING

Operating this Go Kart on any public road or highway could be hazardous.

You could collide with another vehicle if you operate on public roads or highways resulting in severe injury or death.

Never operate on public roads or highways.

OPERATING THE GO KART

HELMET, EYE PROTECTION, PROTECTIVE CLOTHING

Always wear a DOT certified helmet (1). A helmet helps protect against serious head injuries in the event of an accident. A helmet is the most important safety gear item you can wear. Consult with a motorcycle dealer for the correct size and type of helmet that is right for you.

Always wear eye protection when operating a Go Kart such as a face shield or goggles (2). While operating a Go Kart you can be hit in the eyes by any of the following: dust, branches, rocks, debris from other operators, bugs, etc. Good eye protection as well as a helmet and protective operating gear should be mandatory when operating a Go Kart.

Wear protective clothing: Long sleeve shirt (3), Gloves (4), Long pants (5), over the ankle boots (6). Operating a Go Kart exposes the operator to many hazards, wearing protective clothing can help protect the operator from injury.

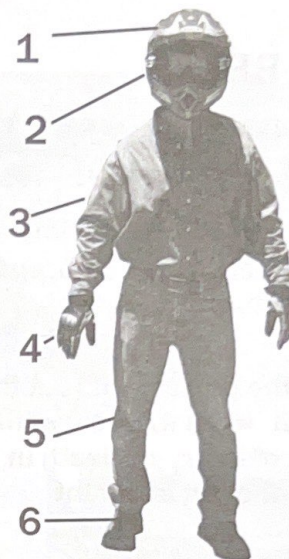

⚠ WARNING

Operating a Go Kart without a helmet, eye protection, and protective clothing can be hazardous

Operating a Go Kart without a helmet increases the chance of severe head injury or death in the event of an accident.

Operating a Go Kart without eye protection such as a face shield or goggles could result in severe injury in the event of an accident.

Operating a Go Kart without protective clothing; closed toe shoes, long pants, gloves, long sleeve shirt could result in severe injury in the event of an accident.

Always wear a Helmet, eye protection, long pants, long sleeve shirt, over the ankle boots and gloves while operating a Go Kart.

OPERATING THE GO KART

SEAT BELTS

WARNING

Riding in this go kart without the seat belt attached properly could be hazardous

Riding the go kart without the seat belt worn increases the chance of injury or death in the event of an accident

Never operate the go kart without the seat belt worn and attached properly.

To connect the seat belt sit in the seat and buckle the lap belt. Make sure the buckle is latched properly.

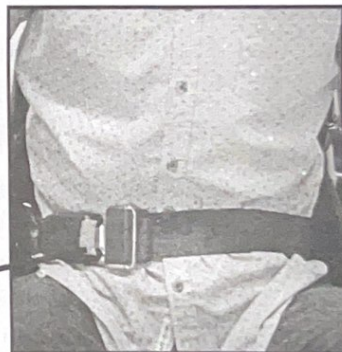

OPERATING THE GO KART

STARTING ENGINE

To start the engine

2. Place the fuel valve (1) in the "ON" (vertical) position.
- 3.. If engine is cold, place the choke lever (2) in the "ON" (right) position.
4. Place the ON/OFF switch (3), located on the Steering column, in the "ON" position.
5. Pull the starter recoil cord (4) to start the engine.
6. Once engine has warmed up for a few minutes, place the choke lever (2) back to the "OFF" (left) position.

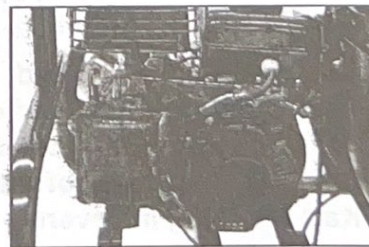
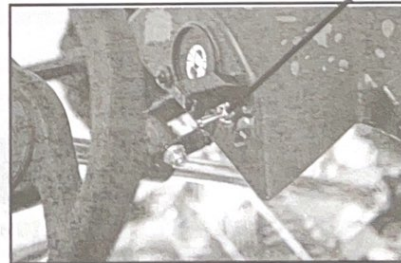
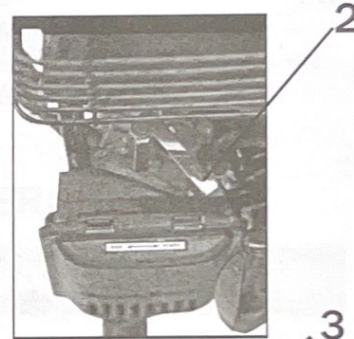
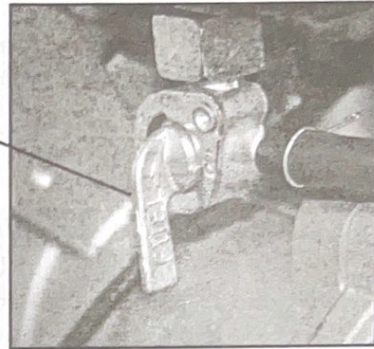

WARNING

Starting or running the Go Kart in an enclosed area such as a garage or shed where there is no ventilation is hazardous.

Inhaling exhaust fumes from the Go Kart can cause severe injury or death.

Never start or run the Go Kart in an inclosed environment where there is no ventilation. Always start and run outdoors.

OPERATING THE GO KART

STARTING OFF

1. Start and warm up the engine according to the instructions in this manual.
2. Sit down in the go-kart and fasten seat belt.
3. Apply throttle gradually to start off. Practice driving the go-kart slowly on a flat dirt surface, make sure that there is plenty of room for turning.

⚠ WARNING

Removing hands from the Steering wheel and/or feet from the floorboard while operating the Go-Kart could be hazardous.

Removing both or one hand from the Steering wheel and/or feet from the floorboard could result in loss of control of the Go-Kart resulting in severe injury or death.

Always Operate with both hands on the steering wheel and both feet on the floorboard while operating the Go-Kart.

⚠ WARNING

Operating this Go-Kart at excessive speeds could be hazardous.

Driving at excessive speeds increases your chances of losing control of the Go-Kart, which could result in severe injury or death.

Always go at a speed that is proper for the terrain, visibility, operating conditions, operator skill, and operator experience. Always know the terrain before operating.

⚠ WARNING

Applying the gas pedal to full throttle when starting off could be hazardous.

The Go-Kart could lurch forward causing the front wheels to leave the ground causing loss of control.

Always open the throttle gradually when starting off from a stopped position.

⚠ WARNING

Braking while turning could be hazardous.

Braking while turning could cause the Go-Kart to slide out of control or flip over which could result in severe injury or death.

Before making a turn, slow down and release the brake.

OPERATING THE GO KART

CLIMBING A HILL

1. Stop and evaluate the hill before attempting to climb. Make sure the hill is not too steep, the terrain is not loose or slippery and that there are no obstacles.
2. Approach the hill at a steady speed and maintain speed throughout the climb.
3. When approaching the top of the hill, slow down.

If it is determined that the Go Kart will not make it to the top of the hill:

1. Do not try to turn the Go Kart around while operating and come back down, this could cause the Go Kart to roll over.
2. Slowly back the Go Kart down the hill while applying the brakes.

DESCENDING A HILL

To operate the Go Kart going down a hill, follow the instructions below.

1. Stop and evaluate the hill before attempting to descend. Make sure the hill is not too steep, the terrain is not loose or slippery and that there are no obstacles.
2. Do not go down the hill on a sharp angle, this could cause the Go Kart to flip over. Instead, go straight down the hill. Apply the brakes on the way down.

TRAVERSING A HILL

WARNING

Traversing a hill could be hazardous.

Traversing a hill could result in losing control and flipping the Go Kart over.

This could result in severe injury or death.

Never attempt to traverse a hill that is too steep or has loose or slippery terrain.

OPERATING THE GO KART

SKIDDING OR SLIDING

In certain situations you may experience skidding or sliding even though the brakes are not applied. Follow the operating techniques listed below to regain control.

Front wheel begins to slide or skid:
To regain traction, let off the throttle, do not apply the brakes.

Rear wheels begin to slide or skid:
To regain traction, let off the throttle and brakes until control of the Go Kart is achieved, steer in the direction of the skid.

WARNING

Skidding or sliding of the Go Kart could be hazardous.

Skidding or sliding could result in the Go Kart sliding into an object or overturning suddenly by regaining traction resulting in severe injury or death.

Avoid skidding or sliding. Drive to stay in control.

WARNING

Applying the parking brake while operating the Go Kart could be hazardous.

Applying the parking brake while operating can cause the wheels to lock up and the Go Kart to slide out of control. The Go Kart could turn over or slide into an object. This could result in severe injury or death.

Apply the parking brake only after the Go Kart has come to a complete stop.

WARNING

Applying the brakes hard on slippery surfaces could be hazardous.

Applying the brakes too hard on a slippery surface can cause the wheels to lock up and the Go Kart to slide out of control. The Go Kart could turn over or slide into an object. This could result in severe injury or death.

Gently apply the brakes when on a slippery surface.

OPERATING THE GO KART

OPERATING THROUGH WATER

Operating through water can be hazardous, especially if it is fast moving. Make sure the water you are operating through is shallow and is not more than 5cm (2in) deep. Before crossing any water look at the terrain entering and exiting the water, the terrain should have a gradual slope with no obstacles. The bottom of the river or pool of shallow water should be hard. If you do not know the terrain or are not sure about the bottom of the pool or river, do attempt to enter. Remember to protect the environment, do not enter a river or pool of water if doing so could damage the river bank or shore line.

Brakes need to be inspected, cleaned and replaced more often if Go Kart is used in muddy, wet or sandy conditions. Inspect the Go Kart brakes regularly, have a service center clean or replace as needed.

WARNING

Operating this Go Kart through fast or deep water could be hazardous;

Deep or fast moving water could cause the Go Kart to loose traction resulting in loss of control which could lead to severe injury or death.

Never operate this Go Kart in water that is more than 2in (5cm) deep. Never operate this Go Kart in fast moving water. Always check brakes after operating through water, wet brakes can reduce stopping ability. Make sure brakes are dried out. The brakes can be dried out from friction by applying the brakes multiple times.

OPERATING THE GO KART

OPERATING IN COLD WEATHER - PRE RIDE INSPECTION

Brake and throttle linkages:

Cold weather requires additional pre-ride inspection of the Go Kart before operating. Inspect brake and throttle linkages making sure they operate freely and correctly. Ice and snow can cause these items to freeze. If the linkages are frozen, move the Go Kart to a warm area until these items thaw and work properly.

Frozen tires:

Check to make sure the Go Kart tires are not frozen to the ground, if they are, pour warm water around the tires to release. Do not attempt to break the Go Kart loose using engine power, this could damage the engine and drive train.

Brake inspection:

Start engine and allow to warm up. Check the braking ability of the Go Kart by applying the brakes on level ground while traveling at a slow (walking rate) of speed. Make sure both front and rear brakes work properly. If the front, rear, or both sets of brakes do not work, take the Go Kart to a warm area to thaw out. Once brakes are thawed, check again for proper operation, if they still do not work, take the Go Kart to a authorized service center. Do not attempt to operate the Go Kart with brakes that do not work correctly.

Preventive maintenance in cold weather operating is important. After operating in cold weather with snow, slush, water or ice, dry off the Go Kart including brake and throttle linkages. Apply the brakes several times making sure that the friction has dried off the brake pads and shoes. Cover the Go Kart with a protective cover so ice and snow cannot accumulate .

CAUTION

Using engine power to release wheels that are frozen to the ground could damage Go Kart.

Damage to engine and drive train may occur if attempting to use engine power to free frozen wheels.

Always make sure wheels move freely before starting the Go Kart in cold weather.

! WARNING

Operating the Go Kart with wet or frozen brakes could be hazardous.

Wet or frozen brakes will increase stopping distance which could result in loss of control which could result in severe injury or death.

Always inspect the brakes before each ride by following the procedures in this manual.

OPERATING THE GO KART

LOAD GUIDELINES

Load guidelines including accessories:

Never exceed the maximum load capability of the Go Kart. This includes the weight of the operator and any cargo. This Go Kart is rated at 150 lbs. (68kg)..

Never allow a passenger. This Go Kart is designed for one operator and no passengers.

Do not add any accessory or cargo to the steering wheel that could impede vision or make the Go Kart harder to steer.

Make sure accessories do not get in the way of any controls of the Go Kart.

AFTER MARKET PARTS

After market parts and accessories are available from many manufactures. Coleman Power sports cannot confirm the quality, safety or suitability of all the accessories available. When purchasing an accessory, use caution, the handling of the Go Kart could become affected. Some accessories may make the Go Kart unsafe to operate. If you have a question about a modification or accessory, contact your dealer or call Coleman Powersports.

WARNING

Modifications or adding accessories could be hazardous.

Modifications to the Go Kart, including adding accessories, could adversely affect the handling of the Go Kart causing an accident which could result in severe injury or death.

Never Modify this Go Kart in anyway, including adding accessories, unless the modification is a genuine certified modification or accessory approved by the manufacture. Never modify the Go Kart with improper installation. Make sure to follow all instructions recommended in the certified modification. Use only genuine parts. For questions, contact your dealer.

MAINTENANCE

For maintenance, your Go Kart may be maintained by an authorized Coleman Powersports service center or a repair shop of your choosing.

Following the proper maintenance procedures and time table for maintenance listed in this manual is important for the safety of the operator and the life span of the Go Kart. When operating in harsh conditions, such as water, mud and dust, the maintenance procedures should be performed more often.

⚠ WARNING

Failing to perform the recommended maintenance on this Go Kart could be hazardous.

Failing to perform proper maintenance on this Go Kart could result in an accident

Always perform the recommended maintenance for the Go Kart as listed in this manual.

⚠ WARNING

Performing maintenance and inspection while the engine is running could be hazardous.

Performing maintenance and inspections while the engine is running could result in getting body parts or clothing caught in moving parts, or could result in touching hot items which could result in severe injury.

Shut off engine when performing maintenance and inspection checks, with the exception checking the ignition switch and throttle.

CAUTION

Failing to perform recommended maintenance on this Go Kart could damage the Go Kart engine and components.

Always perform the recommended maintenance on this Go Kart as listed in this manual. Maintenance will need to be performed more often if ridden in wet, muddy or dusty conditions.

CAUTION

Failing to use compatible parts with the original replacement parts could damage Go Kart.

Using parts that are of low quality could result in Go Kart breakdowns and reduce the useful life of the Go Kart.

Never use parts that are not compatible with the original parts.

MAINTENANCE

ITEM	First 5 hours of operation	Before each ride	Every 20 hours of operation or 1 month	Every 50 hours or 3 months	Every 100 hours or 6 months
Exhaust pipe nuts and muffler bolts	T	I	T		
Air cleaner element	I		I		
Valve Clearance**					I
Spark Plug			I		R
Fuel Line		I			
Idle speed	I		I		
Condition of throttle and brake cables	I	I			
Engine oil	R	I		R	
Drive Chain	Inspect drive chain before each ride. Clean and lubricate as necessary				
Brakes	I		I		
Brake hose	I		I		
Brake fluid	Inspect brake fluid level before each ride, if low, check brake pads for wear and brake lines and components for leaks. Replace brake fluid every 2 years.				
Tires		I			
Steering	I		I		
Front suspension	I		I		
Rear suspension	I		I		
Chassis nuts and bolts	T	I	T		

** Recommended to be performed by an authorized service center or service center of the owner's choosing.

MAINTENANCE

AIR FILTER

The air cleaner element needs to be cleaned or replaced periodically (see chart for cleaning/replacement intervals). The air filter element will need to be cleaned more often if Go Kart is ridden in muddy, wet, or dusty conditions. A clean air filter will help the Go Kart to run at peak performance allowing better gas mileage, more power and will protect the engine from the damaging effects of dirt entering the engine.

CAUTION

Clean air filter more frequently if Go Kart is driven in wet, muddy or dusty conditions.

Driving in the above conditions without cleaning frequently can plug up the air filter which can cause poor gas mileage, low power and cause damage to the engine.

Air filter removal, inspection and cleaning instructions

- 1, Locate the air filter assembly (1)
2. Remove the Air filter assembly cover by lifting the cover over top tabs (2)
3. Remove the foam element (3).
4. Clean foam element with mild soap and water (4). Rinse and squeeze out excess water and allow to dry .

Note: If foam element (3) is damaged, replace.

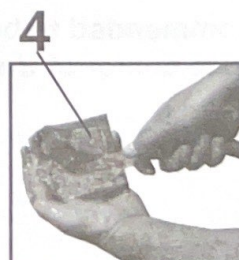
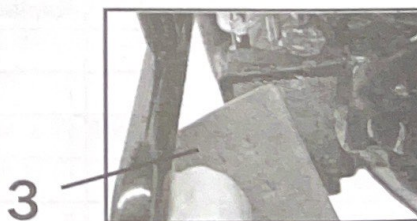
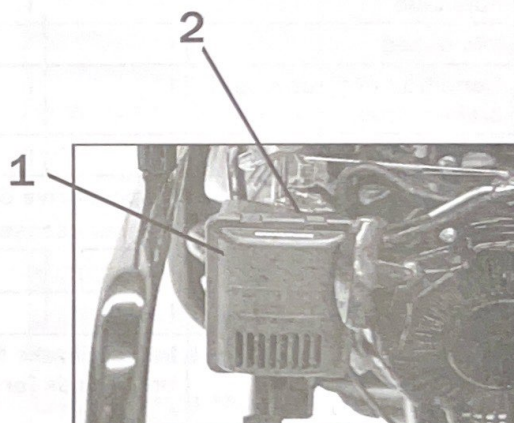

MAINTENANCE

SPARK PLUG

This Go Kart comes equipped with an CHDY - E6TC spark plug.

To inspect the spark plug, remove the plug cap (1) then remove the spark plug (2) from the engine with the spark plug tool provided.

Inspect the plug for carbon deposits and clean if necessary with a wire brush. If plug shows excessive carbon, replace the plug.

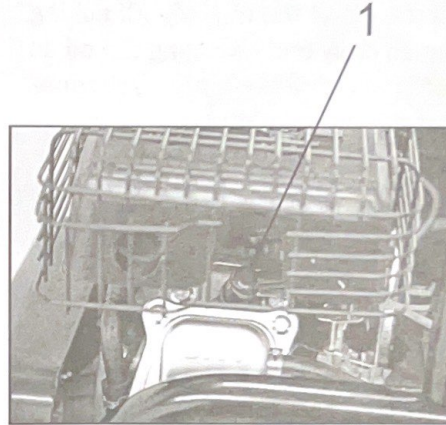

CAUTION

Dirt can damage the engine if it enters the spark plug hole.

Make sure the spark plug hole is covered after removing plug.

Use a thickness feeler to inspect the spark plug gap (2). The spark plug gap should be 0.6 - 0.8mm (0.024 - 0.032 in.)

Re-install the inspected plug or a new plug until finger tight. Finish tightening plug with a wrench. If spark plug is a new plug, tighten approximately 1/2 turn more with the wrench. If plug is an old plug, tighten approximately 1/8 turn more with a wrench.

CHDY - E6TC

0.6 - 0.8 mm
(0.024 - 0.032)

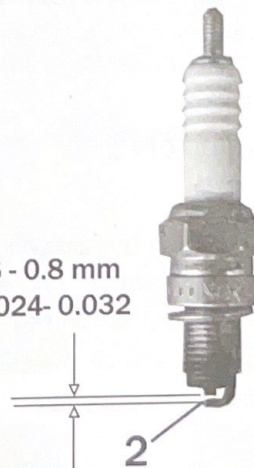

MAINTENANCE

ENGINE OIL

The proper amount and grade of engine oil will have a great impact on the life of the engine. Checking the oil daily and changing the oil as listed in the maintenance schedule is the most important maintenance procedure there is for the engine.

CHECKING THE ENGINE OIL

1. Make sure the Go Kart is on level ground
2. Check engine oil level by removing and looking at the oil plug/dipstick (1). Oil should be close to the top of the serrated portion of the dipstick.
3. If engine oil is low, add oil until oil is at the top of the serrated portion of the dipstick. Use the correct grade of oil as listed in this manual. Do not over or under fill engine with oil, this could damage the engine.

CHANGING THE ENGINE OIL

1. Make sure engine is warm before attempting to drain the oil. A warm engine will help the oil drain quicker.
2. Remove the oil fill plug (1)
3. Remove the drain bolt (2) located on the back bottom portion of the engine.
4. Allow the oil to drain in an appropriate container.
5. Install the drain plug and fill with the appropriate type of oil as listed in this manual. This Go Kart requires 37qt. (.35L) of engine oil.

6. Re- install fill cap, Start engine and allow to run for a few minutes. Re-check oil level and fill accordingly.

⚠ WARNING

New and used oil can be hazardous

Children and pets can be harmed by swallowing new or used oil. Continuous contact with used engine oil has been found to cause skin cancer in laboratory animals

Always keep new or used oil away from children and pets.

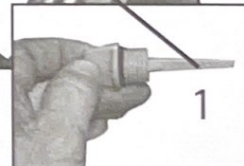
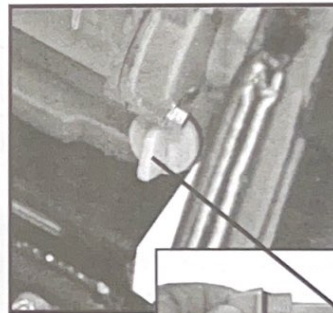

2

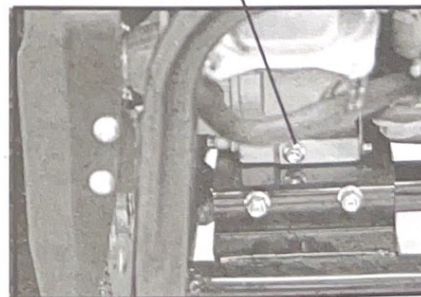

Correct Oil Level

MAINTENANCE

FUEL HOSE INSPECTION

Inspect the fuel hose (1) for any cracks or leaks and make sure all clamps are in place. Replace the fuel hose if any defects are found.

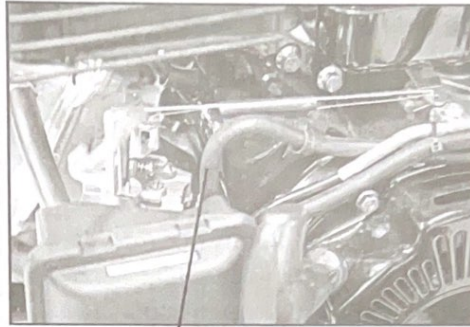

BRAKES

This Go Kart is equipped with rear hydraulic disk brakes

⚠ WARNING

Failing to inspect brakes before each use could be hazardous

Inspect brakes before each use according to the Pre ride check list, make sure to follow the maintenance schedule and procedures.

BRAKE FLUID INSPECTION

Check the brake fluid level (2) for rear brakes. If fluid level is below the lower mark, inspect the brake hoses (3) for leaks or cracks. If there are no leaks, inspect the brake pads for excessive wear. If brake pads are worn, take to a service center for replacement.

To add brake fluid, remove the lid (4). Use only DOT3 or DOT4 brake fluid

1

4

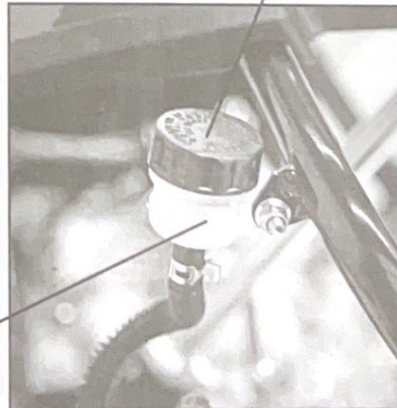

2

3

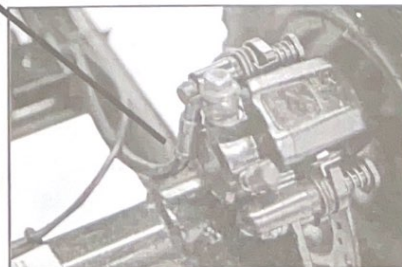

MAINTENANCE

Clutch lubrication

To help ensure the maximum life out of the Centrifugal clutch. It is important to clean and lubricate the clutch after every 5 hours of operation. To Clean and lubricate, follow the instructions below. Make sure engine is not running and that the engine and clutch has had time to cool.

2. Remove clutch cover (1).
3. Wipe off Centrifugal clutch (2) with a clean rag.
4. Lubricate Centrifugal clutch (2) using the same type of motor oil that is used in the engine. Place a few drops of motor oil on the drive shaft (3) where the clutch is attached. Do not oil any other portion of the clutch. DO NOT PLACE ANY OIL IN THE LARGE HOLES IN THE CLUTCH. THE HOLES ARE FOR AIR CIRCULATION ONLY. DO NOT OIL THE INSIDE OF THE CLUTCH.

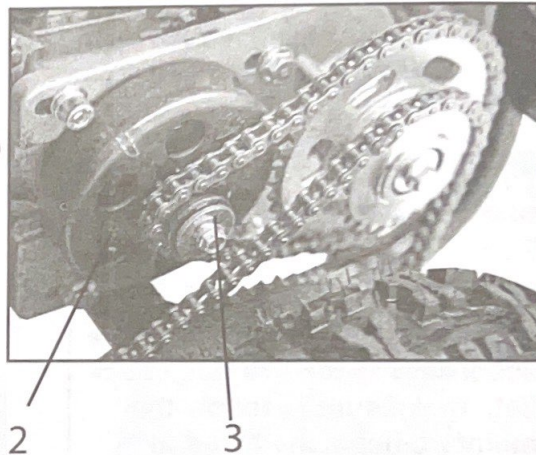
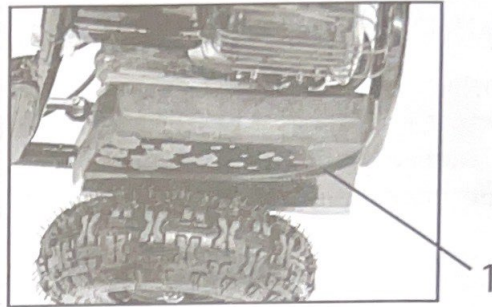

⚠ WARNING

Performing maintenance and inspection on the clutch assembly while the engine is running could be hazardous. Performing maintenance and inspections on the Clutch assembly while the engine is running could result in getting body parts or clothing caught in moving parts, or could result in touching hot items which could result in severe injury.

⚠ WARNING

Operating the Go-Kart without the clutch assembly cover in place could be Hazardous.

Operating the Go-Kart without the clutch assembly cover could result in getting body parts or loose clothing caught in moving parts which could result in severe injury.

Never Start or operate the Go-Kart without the clutch assembly cover in place.

MAINTENANCE

Chain and Sprocket inspection

Inspect drive chain for wear, rust, bound links, proper lubrication and proper tension.

If drive chain has a problem, correct or replace. Contact a service center for chain replacement.

A worn drive chain could also mean the sprockets may be worn. Look for the following on sprockets (1):
Worn teeth, broken or damaged teeth, loose sprocket mounting nuts.

If sprockets show signs of wear, contact a service center for replacement.

Chain Tension

⚠ WARNING

Checking chain tension while the engine is running can cause serious injury.

Always make sure engine is off before checking drive chain tension.

Check tension of drive chain (2), chain tension slack should be 0.2 - 0.5in (5 - 13mm)

Chain tension (slack) Adjustment

1. Loosen nuts (3) on bottom of engine mounting plate.
2. Adjust chain tension by pulling engine backward (tightening) or forward (loosening) chain tension nuts (4).
3. Once the chain is at the correct tension re-tighten nut (3).
4. Re-check chain tension.

Chain Lubrication

Lubricating the chain before each ride will help to ensure maximum life of the chain and sprockets.

Instructions for cleaning and chain lubrication:

1. Clean chain with a chain cleaner or a cleaning lubricant such as WD40.
2. Lubricate chain with chain lube.

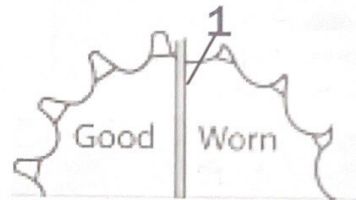

5 - 12mm
(0.2 - 0.5in) 2

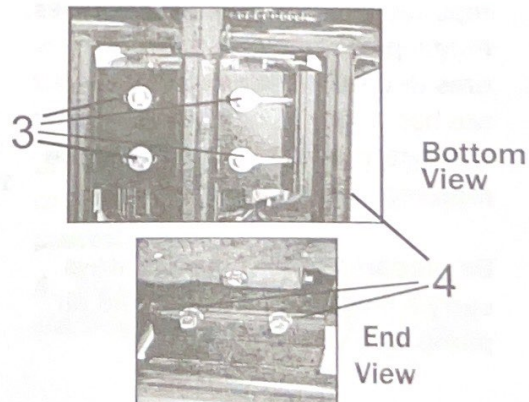
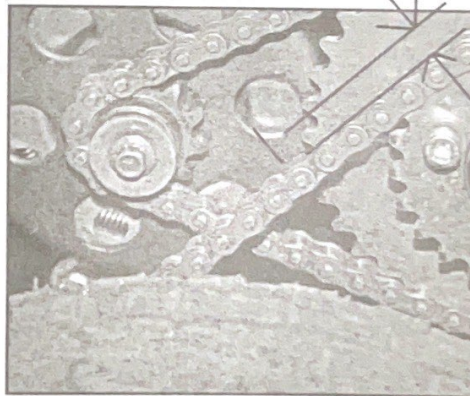

MAINTENANCE

TIRES

Inspect tires before each ride, this should include the following:

1. Inspect for cracks or leaks
2. Inspect tread depth. If tread depth is below 4mm (.16 in.) replace the tire.

3. Check tire pressure. Incorrect tire pressure can affect the handling, operator comfort, steering, tire life and trac-

Tire pressure

Front tires: 14psi

Rear tires: 14psi

Tire size:

Front tires: AT 13/5-6

Rear Tires: AT 13/5-6

Replacing Tires

Always replace tires with type and size listed in this manual.

Always use the correct tools when replacing tires. The bead and sometimes the rim can be damaged by using the wrong type of tools. It is usually best to have tires replaced by an authorized service center. Service centers have the correct equipment and expertise to change tires without causing damage.

Punctures to tires can usually be repaired by using plug type patches. Plug type patches cannot repair tires that have been cut. If the tire has been cut or has a puncture in a location or size that cannot be repaired, replace the tire.

Be prepared for flat tires, always carry a plug type patch kit and air pump with you.



Minimum tread
4mm (.16 in.)



⚠ WARNING

Operating this Go Kart with worn tires could be hazardous.

Operating this Go Kart with worn tires will reduce traction which could result in an accident.

Never operate this Go Kart with tires that have a tread depth of less than 4mm (0.16 in.).

⚠ WARNING

Operating this Go Kart with improper tire sizes or pressure could be hazardous

Operating this Go Kart with improper tire sizes or pressure could result in loss of control of the Go Kart which could result in an accident.

Never operate this Go Kart with improper tire sizes or pressure.

MAINTENANCE

STORAGE

If the Go-Kart is left unused for an extended period of time proper storage maintenance is required.

1. Wash Go-Kart thoroughly, then wax painted parts with a non abrasive auto wax. Coat vinyl seat and rubber parts with a vinyl/rubber protectant. Note: Keep water away from air intake and muffler outlet while washing to avoid water from entering the engine and/or components.

2. Drain carburetor by placing fuel valve (1) to the off (horizontal) position and opening the drain screw (2). Allow all fuel to drain from the carburetor. Once fuel is drained, re-tighten drain screw (2). Note: Make sure to drain fuel in a proper storage container.

3. Fill fuel tank to full with gasoline mixed with fuel stabilizer as recommended by the fuel stabilizer manufacture. Note: Fuel stabilizer can be purchased at most motorcycle shops and auto parts stores.

4. Remove spark plug and pour 1 tablespoon of motor oil in the spark plug hole. Re-install spark plug.

5. Place the starter switch to the off position and pull the start recoil cord a few times. This is to coat the inside cylinder head with oil.

6. Fill tires with correct air pressure.

7. If possible, store Go-Kart in a shed or garage with a cover to protect from dust, dirt and humidity. If the Go-Kart must be stored outdoors, cover completely with a good waterproof cover.

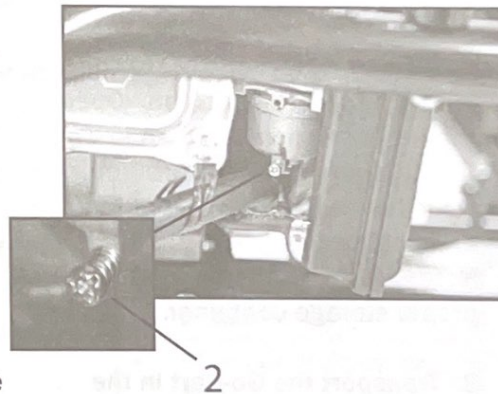
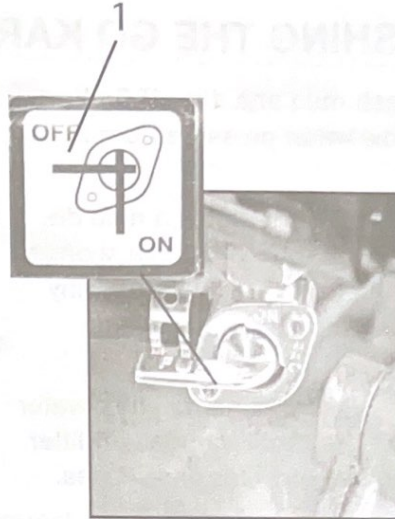

Returning to service

1. Wash Go-Kart thoroughly. Note: Keep water away from air intake and muffler outlet while washing to avoid water from entering the engine and/or components.

2. Drain engine oil and replace with fresh clean oil as listed in this manual.

3. Review this owner's manual and follow the pre-ride inspection procedures.

4. Start engine by following the starting procedures in this manual.

MAINTENANCE

WASHING THE GO KART

1. Wash mud and dirt off Go Kart with low water pressure from a hose.

2. Wash Go Kart using a mild detergent or car soap using a sponge, soft rag or brush. Do not use any cleaning materials that could scratch the Go Kart.

Note: Be careful not to allow water to enter the muffler outlet, air filter intake, brake cables or switches.

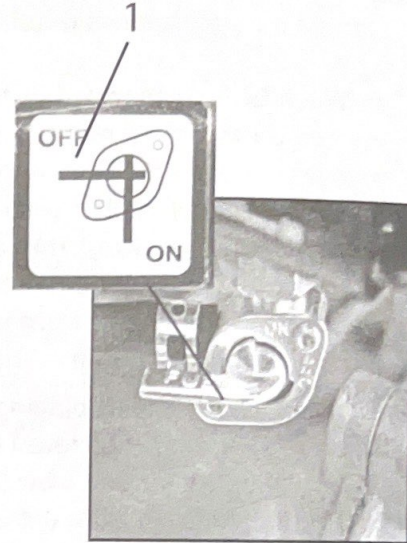

TRANSPORTING

1. Turn the Fuel valve (1) to the "OFF" (horizontal) position. Open the fuel drain screw (2). Allow all fuel to drain from the carburetor. Once fuel is drained, re-tighten drain screw (2).

Note: Make sure to drain fuel in a proper storage container.

3. Transport the Go-Kart in the upright position) tied down securely.

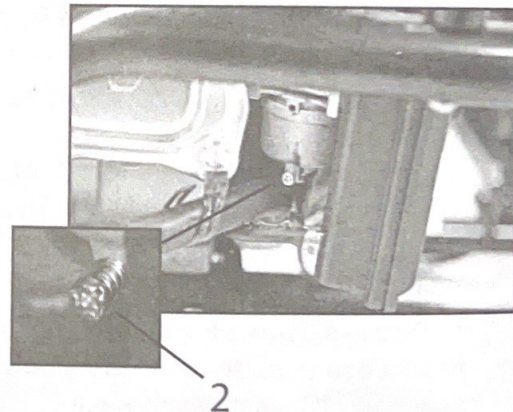

TROUBLESHOOTING

Trouble	Possible cause	Solution
<p>Engine will not start.</p>	<ul style="list-style-type: none"> • Air filter dirty • Low fuel • Stale (old) or contaminated fuel. • Fuel valve is defective • Clogged fuel filter • Loose spark plug • Spark plug fouled or defective. • Spark plug gap is incorrect • Spark plug cap is not attached • Trying to start engine while applying throttle • Low compression • Problem with the electrical system 	<ul style="list-style-type: none"> • Clean or replace air filter • Fill with fresh fuel • Have a service center flush and fill with fresh fuel. • Replace fuel valve • Replace fuel filter • Tighten spark plug • Clean or replace plug • Gap the plug • Attach spark plug cap • Do not apply throttle while starting engine • Take to a service center for repair • Take to a service center for diagnostics and repair
<p>Engine stalls or runs erratically</p>	<ul style="list-style-type: none"> • Air filter dirty • Low fuel • Stale or contaminated fuel • Spark plug is fouled or defective • Spark plug gap is incorrect • Spark plug cap is loose • Carburetor is clogged or has water in it • Idle is not adjusted properly • Problem with the electrical system • Low compression 	<ul style="list-style-type: none"> • Clean or replace air filter • Fill with fresh fuel • Have a service center flush and fill with fresh fuel. • Clean or replace plug • Gap the plug • Secure the spark plug cap • Take to a service center • Take to a service center • Take to a service center for diagnostics and repair • Take to a service center for repair

TORQUE SPECIFICATIONS

FASTNER THREAD SIZE	TORQUE (ft.lbs.) / (in.lbs.)	TORQUE (nm)
5 mm bolts and nuts	39-52 in.lbs.	4.5 - 6 nm
6mm bolts and nuts	69 - 104 in. lbs.	8 - 12 nm
8mm bolts and nuts	13 - 18 ft.lbs.	18 - 25 nm
10 mm bolts and nuts	22 - 29 ft.lbs.	30 - 40 nm
12 mm bolts and nuts	36 - 43 ft.lbs.	50-60 nm
4 mm screws 22-30	22 - 30 in.lbs.	2.5-3.4 nm
5mm screws	30 - 43 in.lbs.	3.5 - 5 nm
6 mm hex bolts	87 - 121 in.lbs.	10 - 14 nm
8 mm hex bolts	17 - 22 ft.lbs.	24 - 30 nm
10 mm hex bolts	25 - 32 ft.lbs.	35 - 45 nm

VEHICLE IDENTIFICATION NUMBER LOCATION

The Vehicle identification number is needed when calling for parts, service center help or when registering your Go Kart. Locate the number and list the number below for your reference.

The 17 digit Vehicle Identification Number (VIN) is stamped on the left rear bumper support frame on the go-kart.

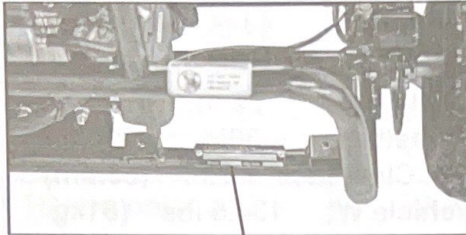

Vehicle Identification Number:

--	--	--	--	--	--	--	--	--	--	--	--	--	--	--	--	--	--	--	--	--

VIN #

Coleman Powersports Emission Control System Warranty

Your new engine complies with the U.S. EPA (Environmental Protection Agency) regulations, State of California emission regulations (models certified for sale in California only) and Canada EPA regulations. Coleman Powersports provides the emission warranty coverage for engines in the United States and its territories. Coleman Powersports, provides the emission warranty for engines in the 13 provinces and territories of Canada. In the remainder of this Emission Control System Warranty,

YOUR WARRANTY RIGHTS AND OBLIGATIONS:

California

The California Air Resources Board and Coleman Powersports are pleased to explain the emission control system warranty on your engine. In California, new spark-ignited small off-road equipment engines must be designed, built, and equipped to meet the State's stringent anti-smog standards. **Other States, U.S. territories, and Canada**

In other areas of the United States and in Canada, your engine must be designed, built, and equipped to meet the U.S. EPA and Environment Canada emission standards for spark-ignited engines at or below 19 kilowatts.

All of the United States and Canada

Coleman Powersports must warrant the emission control system on your power equipment engine for the period of time listed below, provided there has been no abuse, neglect, or improper maintenance of your power equipment engine. Where a warrantable condition exists, Coleman Powersports will repair your power equipment engine at no cost to you including diagnosis, parts, and labor.

Your emission control system may include such parts as the carburetor or fuel injection system, the ignition system, and catalytic converter. Also included may be hoses, connectors, and other emission-related assemblies (see page 2 for additional covered parts).

OWNER'S WARRANTY RESPONSIBILITY:

As the power equipment engine owner, you are responsible for the performance of the required maintenance listed in your owner's manual. Coleman Powersports recommends that you retain all receipts covering maintenance on your power equipment engine, but Coleman Powersports cannot deny warranty coverage solely for the lack of receipts or for your failure to ensure the performance of all scheduled maintenance.

As the power equipment engine owner, you should however be aware Coleman Powersports may deny you warranty coverage if your power equipment engine or a part has failed due to abuse, neglect, improper maintenance, or unapproved modifications.

You are responsible for presenting your power equipment engine to a Coleman Powersports service dealer as soon as a problem exists. The emission related warranty repairs should be completed in a reasonable amount of time, not to exceed 30 days. If you have any questions regarding your emission warranty rights and responsibilities, you should contact Coleman Powersports

Coleman Powersports
1775 E. University Dr. Tempe,
AZ. 85281
Phone: (888) 405-8725
Fax : (800) 379-0385
Email: support@colepow.com

WARRANTY COVERAGE:

Engines sold in the United States and Canada are covered by this warranty for a period of two years from the date of delivery to the original retail purchaser. This warranty is transferable to each subsequent purchaser for the duration of the warranty period.

If any emission-related part on your engine is defective, the part will be repaired or replaced by Coleman Powersports without charge for diagnosis, parts, or labor. All defective parts replaced under this warranty become the property of Coleman Powersports. A list of warranted parts is on this warranty statement. Normal maintenance items, such as spark plugs and filters, that are on the warranted parts list are warranted up to their required replacement interval only.

Coleman Powersports will also replace other engine components damaged by a failure of any warranted part during the warranty period.

Only Coleman Powersports approved parts can be used for replacement . The use of replacement parts not equivalent to the original parts may impair the effectiveness of your engine emission control system. If such a replacement part is used in the repair or maintenance of your engine, and an authorized Coleman Powersports service center/dealer determines it is defective or causes a failure of a warranted part, your claim for repair of your engine may be denied. If the part in question is not related to the reason your engine requires repair, your claim will not be denied

TO OBTAIN WARRANTY SERVICE:

You must, at your own expense, take your engine or the product on which it is installed, along with your sales registration card or other proof of original purchase date, to any Coleman Powersports dealer who is authorized by Coleman Powersports to sell and service the Coleman Powersport product during normal business hours. Claims for repair or adjustment found to be caused solely by defects in material or workmanship will not be denied because the Coleman Powersport engine was not properly maintained and used.

If you are unable to obtain emission warranty service or are dissatisfied with the warranty service you received, contact the owner of the Service Center/Dealership involved. Normally this should resolve your problem. However, if you require further assistance, contact Coleman Powersports

Coleman Powersports
1775 E. University Dr. Tempe,
AZ. 85281
Phone: (888) 405-8725
Fax : (800) 379-0385
Email: support@colepow.com

EXCLUSIONS:

Failures other than those resulting from defects in material or workmanship are not covered by this warranty. This warranty does not extend to emission control systems or parts that are affected or damaged by owner abuse, neglect, improper maintenance, misuse, misfueling, improper storage, collision, the incorporation of, or use of, unsuitable attachments, or the unauthorized alteration of any part.

This warranty does not cover replacement of expendable maintenance items made in connection with required maintenance service after the item's first scheduled replacement as listed in the maintenance section of the product owner's manual, such as: spark plugs and filters.

Disclaimer of Consequential Damage and Limitation of Implied Warranties:

Coleman Powersports disclaim any responsibility for incidental or consequential damages such as loss of time or the use of the power

equipment, or any commercial loss due to the failure of the equipment; and any implied warranties are limited to the duration of this written warranty. This warranty is applicable only where the California, U.S. EPA, or Environment Canada emission control system warranty regulation is in effect.

SYSTEMS COVERED UNDER THIS WARRANTY:	PARTS DESCRIPTION:
Fuel Metering	Carburetor assembly (includes starting enrichment system), Engine temperature sensor, Engine control module, Fuel regulator, Intake manifold
Evaporative	Fuel tank, Fuel hoses, Vapor hoses, Carbon canister, Canister mounting brackets, Fuel strainer, Fuel cock, Fuel pump, Fuel hose joint, Canister purge hose joint
Exhaust	Catalyst, Exhaust manifold
Air Induction	Air filter housing, Air filter element
Ignition	Flywheel magneto, Ignition pulse generator, Crankshaft position sensor, Power coil, Ignition coil assembly, Ignition control module, Spark plug cap, Spark plug
Crankcase Emission Control	Crankcase breather tube, Oil filler cap
Miscellaneous Parts	Tubing, fittings, seals, gaskets, and clamps associated with these listed systems



POWERSPORTS

**1775 E. University Dr.
Tempe, AZ. 85281**

PHONE: Toll Free 888-405-8725

<https://www.colemanpowered.com>

<https://www.facebook.com/colemanpowersportusa>

https://www.instagram.com/colemanpowersports_usa