

FEATURES

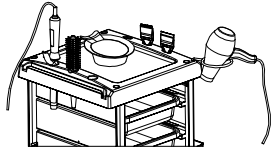

With holders for various hairdressing tools

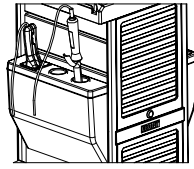

With built-in metal appliance holders

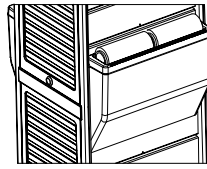

With holder and saw cutter for foil rollers

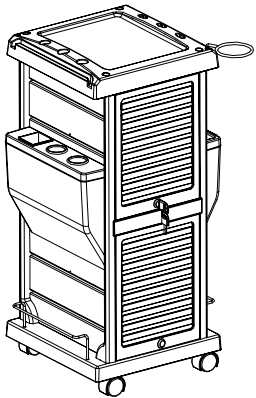

With 2 lockable doors that really work.
Universal key for both doors

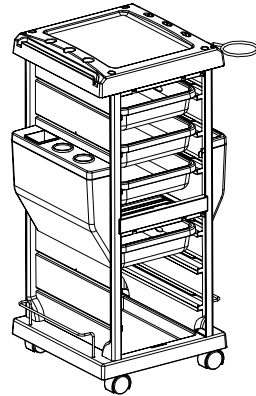
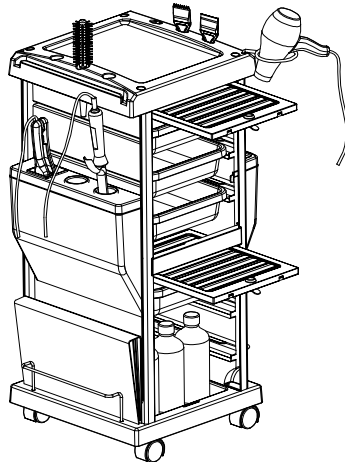

The door slips smoothly into the cabinet and "disappears"

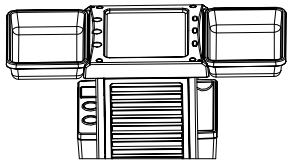

Removable trays can be clipped to both sides of the top, triple your working space



Adequate space for large bottles

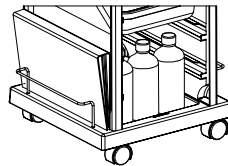

Comfortably accommodate your Color Charts or Magazines



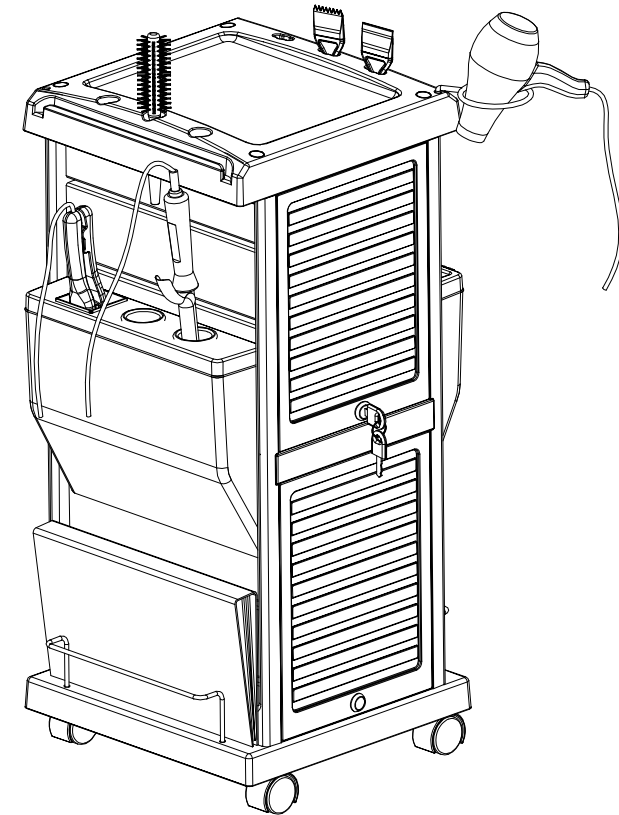

Instructions Manual

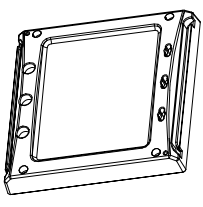
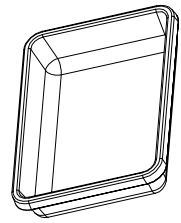

SUPER DELUXE LOCKABLE SALON TROLLEY

Designed by and for Professionals
Your Personal Hairdressing Assistant

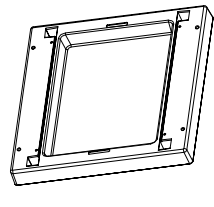
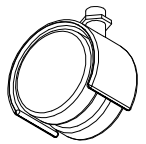
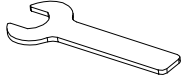
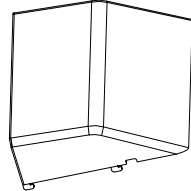
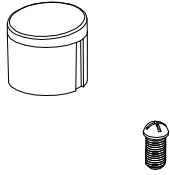
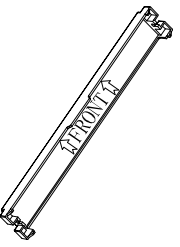
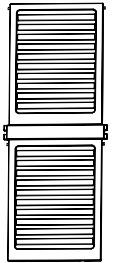
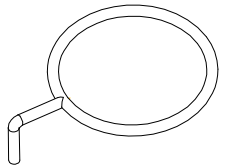
PART LIST

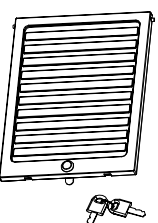
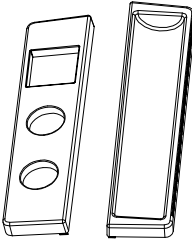
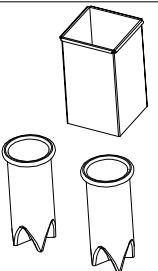
A:Top tray 1PC	B:Removable tray 4PCS	C:Side panel 2PCS	D:Bottom tray 1PC
			
E:Wheel 4PCS	F:Tool 1PC	G:Side compartment 2PCS	H:Bolt and cap 4SETS
			
I: Front connector with screws 1PC	J:Back panel 1SET	K: Blow dryer holder 1PC	L:Balusterade 2PCS
			
M: Front door with lock 2PCS	N: Compartment cover 1SET	O: Appliance holders 1SET	
			

INSTALLATION

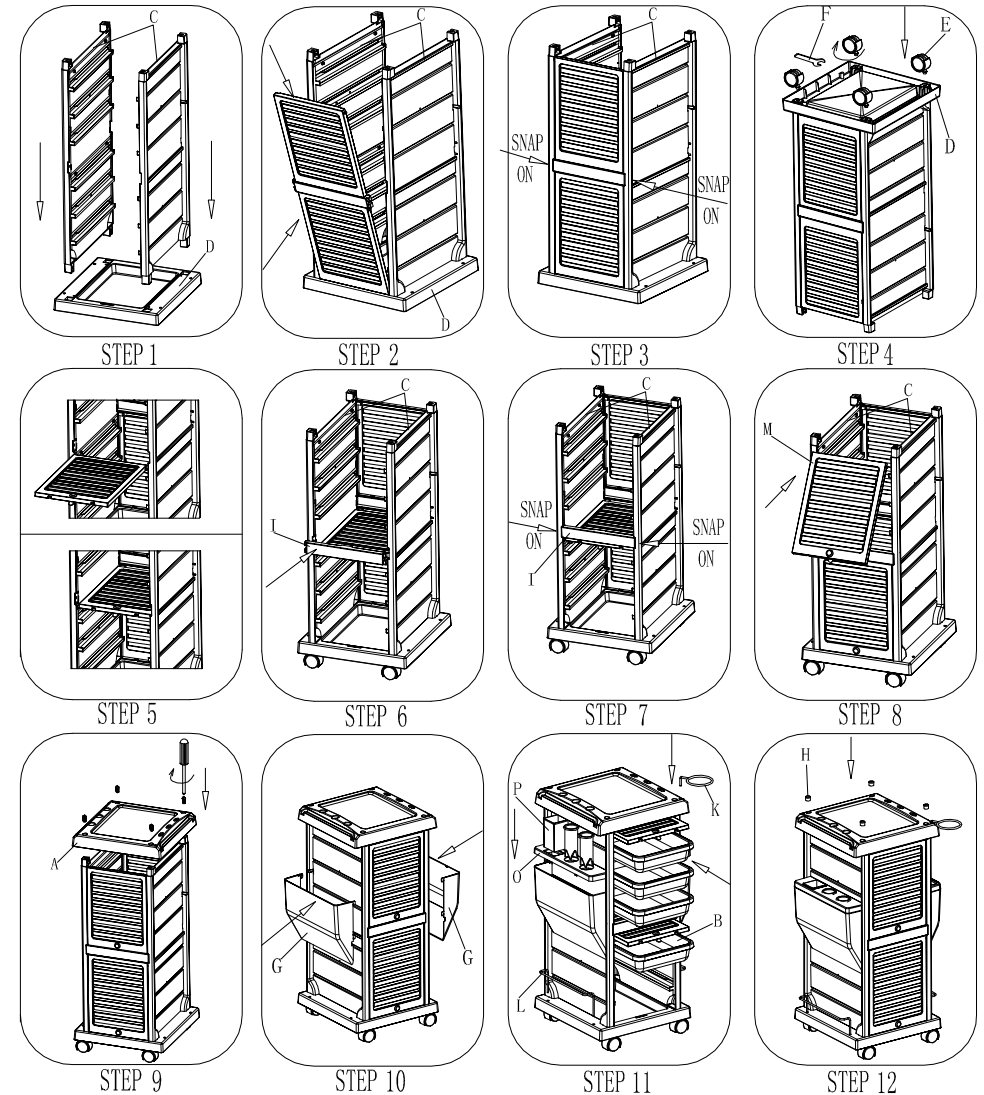

- STEP 1: Insert the 2 side panels(C) into the bottom tray(D),
- STEP 2-3: Position the Back Panel(J) between the 2 Side Panels(C), and snap on in the middle section of the side panels
- STEP 4: Screw the 4 Wheels(E) into the threads in the bottom of the side panels, and fasten with the tool(F). Make sure the wheels are securely fasten.
- STEP 5: Insert one of the Front Doors(M) into the rails in the middle of the side panels, and completely slide in.
- STEP 6-7: Position the Front Connector(I) between middle section of the 2 Side Panels(C), and snap on
- STEP 8: Insert another Front Door(M) in to the rails in the top of side panels.
- STEP 9: Cover the Top Tray(A) onto the top of side panels, and fasten with the 4 bolts(enclosed). Please DO NOT cover the Screw Hole Caps(H) at this moment.
- STEP 10: Attach the Side Compartments(G) to the side panels. Make sure all the 4 hooks were aligned correctly to the slots in the side panels.
- STEP 11: Put the Compartment Covers(N) and the Appliance Holders(O) onto the top of Side Compartments(G). Slide in the 4 Removable Trays(B), install the Blow Dryer Holder(K) and 2 Balusters(L).
- STEP 12: If the above steps were successfully done, put on the Screw Hole Caps(H) into the 4 holes in the Top Tray.