

# HOW TO PUT THIS SH\*T TOGETHER

TUSHY CLASSIC

Check out our installation video at [HELLOTUSHY.COM/CLASSICINSTALL](https://www.hellotushy.com/classicinstall) and some common setup tips at [HELLOTUSHY.COM/HACKS](https://www.hellotushy.com/hacks)

TUSHY

## CONGRATULATIONS

You have seized the bidet! Your butt, the environment and the world will be better off because of it. Install your TUSHY (using our cheeky instructions inside this lil booklet) and flaunt that shiney hiney! Happy pooping.

## KNOW YOUR TUSHY

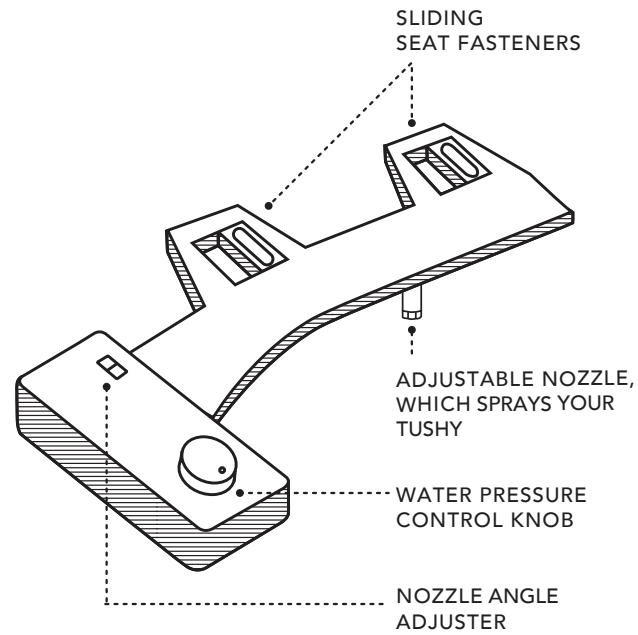

### INCLUDED PARTS

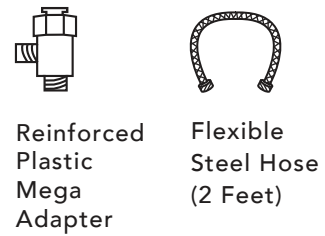

### EXTRAS



### YOU ALSO NEED



Have a question? Don't be shy!  
Email us your questions at [SUPPORT@HELLOTUSHY.COM](mailto:SUPPORT@HELLOTUSHY.COM)

## BEFORE YOU START CHECK YOUR TOILET

### What kind of connection does your toilet have?

If you have a flushometer toilet (left), skirted toilet (right) or an unreachable connection, check out [HELLOTUSHY.COM/HACKS](https://www.hellotushy.com/hacks) for some tips.

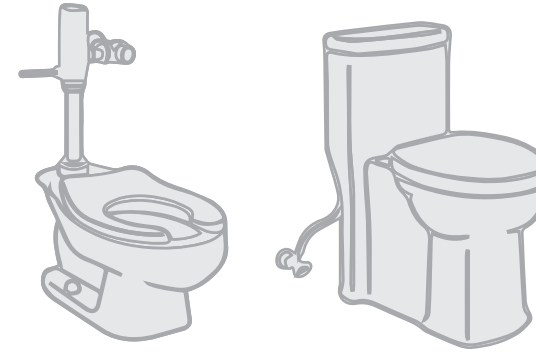

### Do you have a metal pipe instead of a flexible hose?

No problem, visit [HELLOTUSHY.COM/PARTS](https://www.hellotushy.com/parts) or your local hardware store to get a flexible hose. You'll want a flexible steel hose that's 3/8" x 7/8".

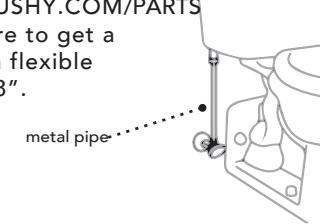

## 1. TURN OFF WATER VALVE

Turn off the water valve beside the toilet by turning clockwise.

If the valve is tight, there may be some mineral build up (white calcification) - slow and steady wins the race. If it's stuck, try twisting it in one direction and then the other, each time rotating a little further until it's free to turn all the way around.

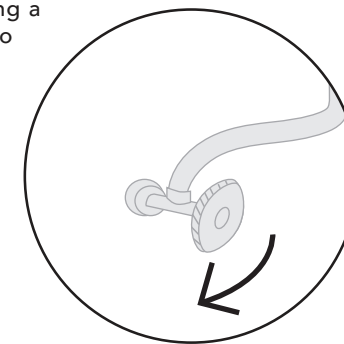

**Still won't budge?**  
Check out [HELLOTUSHY.COM/HACKS](https://www.hellotushy.com/hacks) for some tips.

## 2. EMPTY TOILET TANK

Flush your toilet to drain the tank completely. Hold down that flusher until the tank empties nearly completely! A couple inches of water at the bottom of the tank is okay, though.

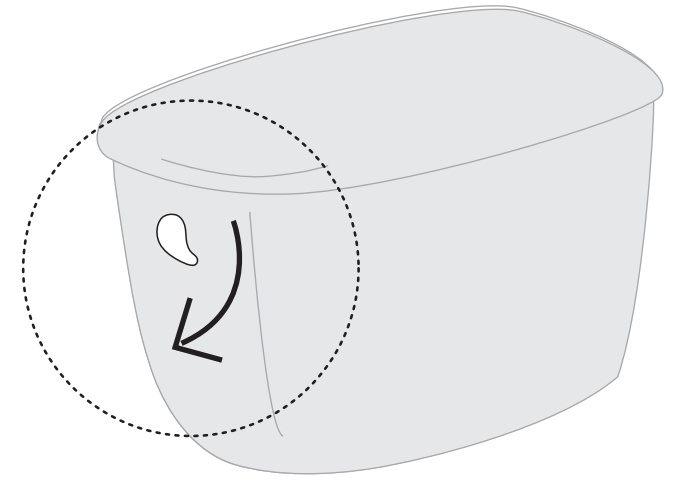

## 3. REMOVE TOILET SEAT

Flip up the screw caps behind the seat with a flat head screwdriver to access the screws. You may need to hold the bolt on the underside of the screw with your other hand while unscrewing. Remove the seat and set aside.

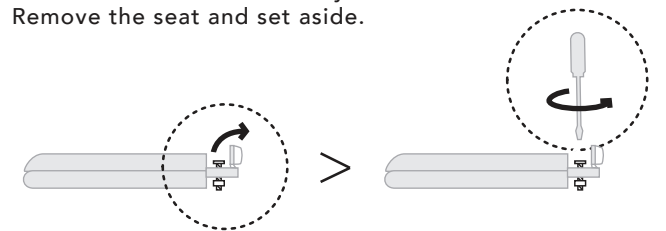

### Dealing with a unique quick-release or mounted toilet seat?

There's a super easy fix. Just remove those toilet seat mounts and place them on top of the TUSHY. Once they're reattached above the TUSHY, you can place the toilet seat back onto the mounts! Check out [HELLOTUSHY.COM/HACKS](https://www.hellotushy.com/hacks) for some more tips/videos.

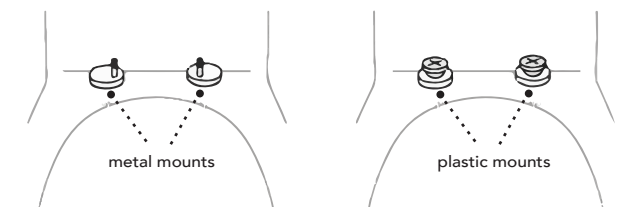

## 4. WATER CONNECTION

4a.

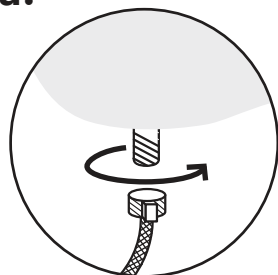

Disconnect the existing flexible hose from your toilet tank by turning it counter clockwise, disconnecting it from the bolt under the tank.

4b.

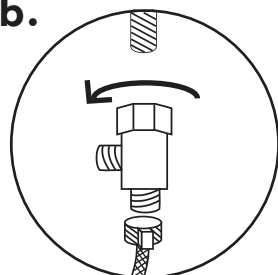

Attach the flexible hose to the bottom of the mega adapter and then screw the top of the mega adapter clockwise onto the tank connection. Be careful not to over-tighten! \*

4c.

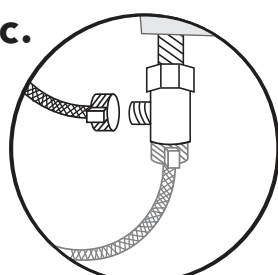

Attach the flexible steel hose to the mega adapter side connection. Use a wrench to tighten it if necessary, but remember: don't over-tighten! \*

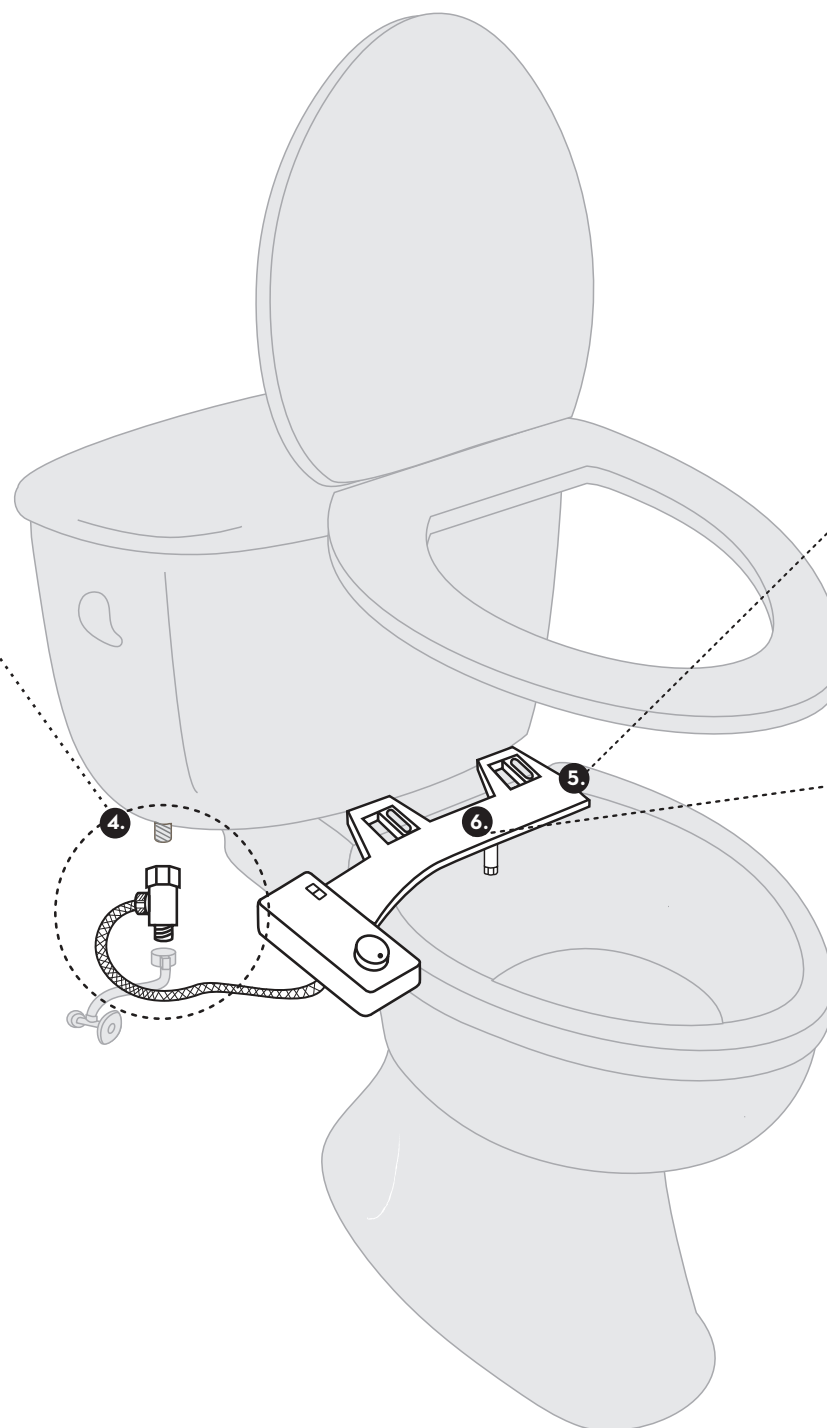

5.

## FINISHING UP WATER CONNECTION

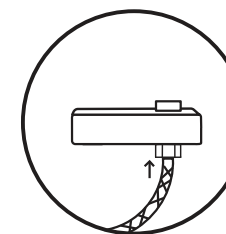

Hand-tighten the other end of the flexible steel hose to the connection under your TUSHY. Use a wrench to tighten, if necessary.

Make sure all the connections are secure and turn on the water supply. Don't forget to check every connection for leaks. \*\*

6.

## ATTACHING TO THE BOWL

6a.

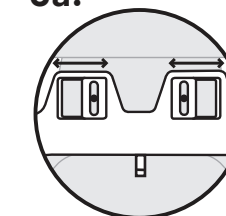

Now for the big moment... place the TUSHY on top of your toilet and line up the sliding seat fasteners with the holes in between the bowl and the tank used for mounting the toilet seat.

**Tip:** Place the rubber pads, provided in the box, over the holes on the toilet and then place the TUSHY on top for extra grip to limit seat movement.

6b.

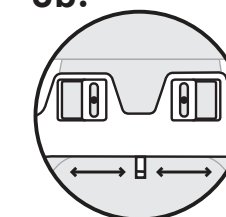

Make sure the nozzle is lined up in the center of the back and not too close to the edge of the bowl to allow room for it to be adjusted in use. \*\*\*

6c.

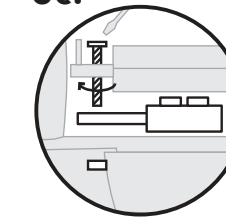

Reattach the toilet seat on top of the TUSHY by threading the toilet seat bolts through the sliding seat fasteners and through the toilet's mounting holes. Fasten the bolts by turning them clockwise.

**Tip:** Hold the underside toilet nuts to tighten from the top more effectively.

\*

**PSST!**

Over-tightening the adapter can cause damage to the threads and result in water leakage, so use only hand pressure at first.

\*\*

**Leaky joints?**

Plug these freaky leaky connections by wrapping teflon tape on the threading of the pipe clockwise while maintaining some tension on it. Leave some room at the end so that there is no fraying of the tape when you are securing the adapters. [HELLOTUSHY.COM/TAPE](http://HELLOTUSHY.COM/TAPE)

\*\*\*

**Leg room for the nozzle**

Make sure that the bidet sits far enough from the rim of the toilet bowl so the nozzle has enough room to swing up and back. You can do so by just playing with the nozzle adjuster on the bidet console.