



# Paul's Outpost One Play-set Plan



For e-mail support, contact [Paul@PaulsPlayhouses.com](mailto:Paul@PaulsPlayhouses.com)





# Terms & Conditions

## Limitation of Liability

In no event shall Paul's Playhouses or its affiliates, officers, directors, employees, agents or suppliers be liable for any direct, special, incidental, indirect or consequential damages, or any other damages of any kind, including, but not limited to, loss of use, loss of profits or loss of data, whether in an action in contract, tort (including, but not limited to, negligence), or otherwise, arising out of or in any way connected with the use of, or inability to use this plan or the content or services contained on, or accessed through this plan, even if Paul's Playhouses has been advised of the possibility of such damages.

## Disclaimer

This plan and the content available on it and any services provided on or in connection with this plan are provided on an "as is" and "as available" basis without warranties of any kind, either express or implied, and you agree that use of this plan and/or its content is at your sole risk. Paul's Playhouses disclaims all warranties, express or implied, including, but not limited to, implied warranties of merchantability, fitness for a particular purpose, title and non-infringement. Paul's Playhouses does not represent or warrant that materials on this plan are accurate, complete, reliable, current, or error-free. You acknowledge that your use of this plan and content is at your sole risk.

Some jurisdictions do not allow the limitation or exclusion of liability for incidental or consequential damages, so some of the above may not apply to you.

## Copyright

All plan materials, including, without limitation, the company logo, and all designs, text, graphics, pictures, recipes, information, data, software, messages, and other files and materials in this plan, paulsplayhouses.com and the selection and arrangement thereof (collectively, "content") are the copyright and proprietary property of Paul's Playhouses or its affiliates, users or licensors.

Any other use of content, including any commercial use, reproduction for purposes other than described above, modification, distribution, republication, display, or performance, without the prior written permission of Paul's Playhouses is strictly prohibited.

## **Links**

When you click on links in this plan or Paulsplayhouses.com, they may direct you away from our site. Some of the links may be affiliate links, where if a purchase is made, we would receive some of the money. We are not responsible for the privacy practices of other sites and encourage you to read their privacy statements.

## **License**

With these plans, provided by Paul's Playhouses, you are thereby granted, subject to these terms a limited, non-exclusive license to use these plans to build the structure depicted in them one time and one time only; and to modify and reproduce these plans solely to the extent required for purposes of satisfying your specific needs and/or to meet the requirements of your specific state and local building codes, ordinances or regulations in completing the project. In addition to any other requirements set forth in these terms you agree to comply with the following restrictions, requirements and conditions to which the license is subject:

1. You shall not, and shall not authorize or permit anyone else to, sell, redistribute or publish these plans, or otherwise disclose these plans to anyone other than contractors, consultants, lenders or governmental agencies on a "need to know" basis as reasonably required for the purpose of building a single structure subject to the license.
2. You may not create derivative works based on these plans other than such modifications as may be required for your own use in building a single structure in accordance herewith.



## Introduction

Thanks for downloading Paul's Outpost One Play-set Plan! We hope that both the building process and the final, complete project make for a great time for the whole family.

Before beginning, make sure to read over the entire plan to get a feel for the project and add up and compile all the materials that will be needed. If you have any questions, feel free to send off an email. Don't forget to reference the below points before and during the build too. Happy play housing!



## Before you swing that hammer:

Construction Tips & Guide

- **Screwing & Nailing:**
  - Use two screws/nails to connect 2x4s together, three screws/nails for 2x6s, etc.
  - Use two, 2" decking screws 3/4" away from the edges to attach 5/4" decking.
  - Use two 1/2" carriage bolts to attach any 4x4 posts to a joist.
  - Screw/nail every 6" along the edges and every 12" in the "field" to attach plywood.
  - Toe screwing may also be needed to attach some joints together.
  - We recommend using screws over nails as it secures the building materials together more effectively.
  - Use our "[How to Frame](#)" page for a more detailed and comprehensive set of framing instructions.
- Many hardware stores offer a lumber delivery service and a bulk purchase discount, which we encourage you to take full advantage of to save time, money and hassle. Paint, hardware, roofing materials and other accessories can also be bought at this time.
- If the project will not be on ground posts, the structure should be built on a flat, level grade that is slightly larger than the footprint's dimensions. Regrading may be necessary to achieve level ground. This area should also be at least 6' from any other structure or obstacle.
- For the structure's foundation, 4x4s, concrete blocks or anchored ground posts with support beams can be used to keep the project level and off the ground. Building the structure on in-ground posts & beams, or on an Island deck of equal size is the most secure

recourse and the method we recommend.

- When building, make sure all the framing is square. You can achieve this by cross measuring the corners to see if they're equal, or use the [3,4,5 rule](#).
- Be advised that if an exact 8', 10', 12' or 16' piece is required, you may still need to cut it as they can vary in length by up to an inch.
- [Cross bracing](#) with wood or cable can be used to help stiffen up a platform and prevent it from wobbling.
- Make sure to paint or stain all the exterior lumber to keep it safe from the rain and other elements. All exterior framing and decking material should be pressure treated or intended for the outdoors.
- Be sure to check out our playhouse [Accessories page](#). There, you will find the correct sized windows, slides, as well as other play attachments for your project. Note that if your deck height doesn't exactly match an available slide height, opt for the next largest size.
- If you are thinking about incorporating a tree into your playhouse design, be sure to check out [TreehouseSupplies.com](#) for treehouse hardware, kits, zip-lines and other accessories.
- Spreading mulch and having distinguished walks can help reduce trip and fall injuries. Be sure to also add handles in climbing areas, as well as sand sharp edges in high traffic areas.
- Read over the United States CPSC's [Outdoor Home Playground Safety Handbook](#). This short publication goes over important safety factors when it comes to a variety of topics regarding backyard play structures.
- For areas that use the metric system: **1" = 2.54cm** | **1' = 30.48cm**
- Many answers to common questions can be found on the [FAQ](#) page.
- Don't forget to send your finished project photos to our facebook page or e-mail. We would love to add your project to our website and social media pages for others to see and enjoy! You can also leave a review for individual plans on our website too.

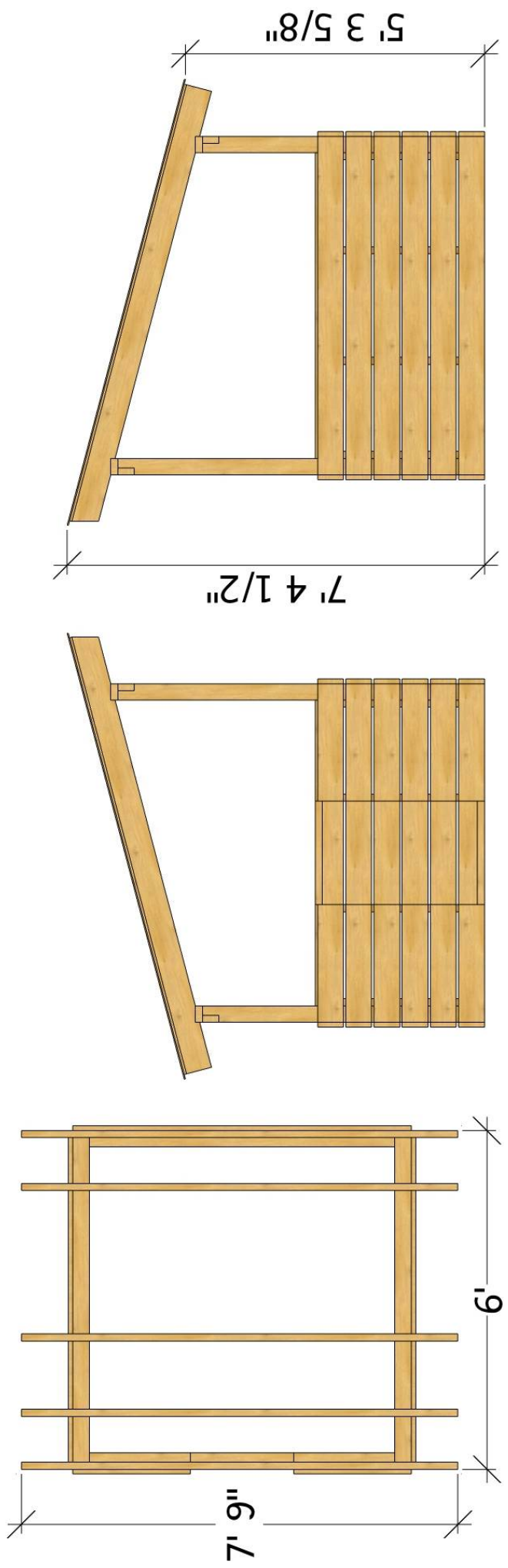
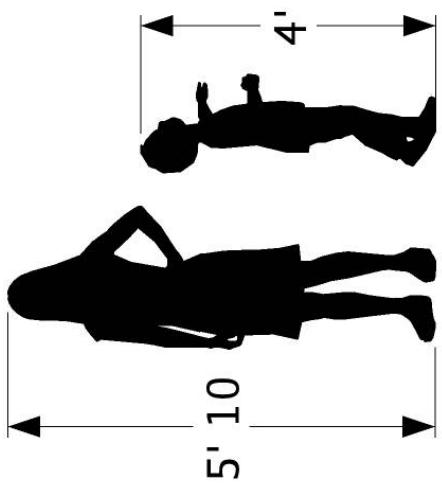
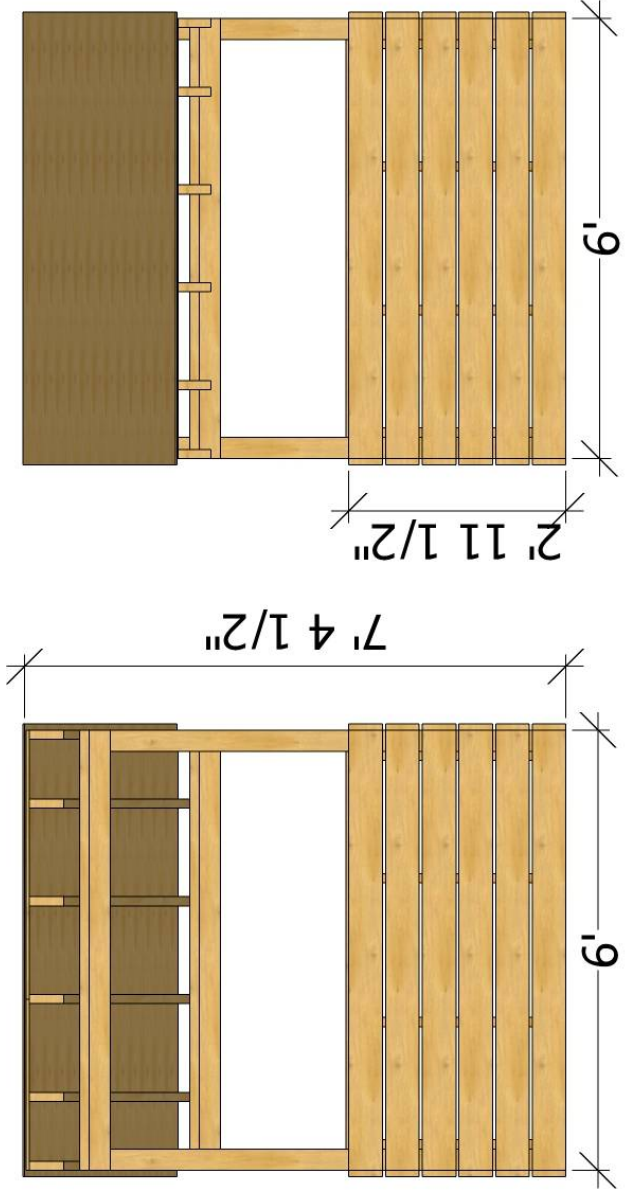



## Hardware List

### Screws:

- (5 lbs) [GRK 3" R4 Screws](#)
- (5 lbs) [GRK 2.5" R4 Screws](#)
- (Optional) [GRK 4" RSS](#)

### 1/2" Bolts:

N/A

### Windows:

N/A



## Tools

[Pencils](#)

[Hand saw](#)

[Measuring Tape](#)

[Speed Square](#)

[Hammer](#)

[Drill & Impact Driver](#)

[Circular Saw](#)

[Sander](#)

[Jig Saw](#)

[Miter Saw](#)

[Chalk Line](#)

[Reciprocating saw](#)

(optional)

(optional)

(optional)

(optional)



## Lumber List

### Decking:

- (3) 5/4" x 6" x 10'
- (9) 5/4" x 6" x 12'

### Framing:

- (1) 2" x 4" x 10'
- (9) 2" x 4" x 12'
- (6) 2" x 6" x 8'
- (2) 4" x 4" x 8'
- (1) 4" x 4" x 10'

### Other:

- (2) 4' x 8' x 1/2" Plywood



## Roofing

The total roofing area is **50** square feet. Generally, account for a 10% waste factor when buying roofing material. If asphalt shingles are being used, see the packaging for determining how much to purchase and installation instructions.



# 1

## Framing the Back Wall

From (1) 2x4x12, cut a 6' piece and a 5' 5" piece.

From (1) 2x4x12, cut four 2' 9" pieces.

Assemble these pieces into the unit shown in the right illustration.

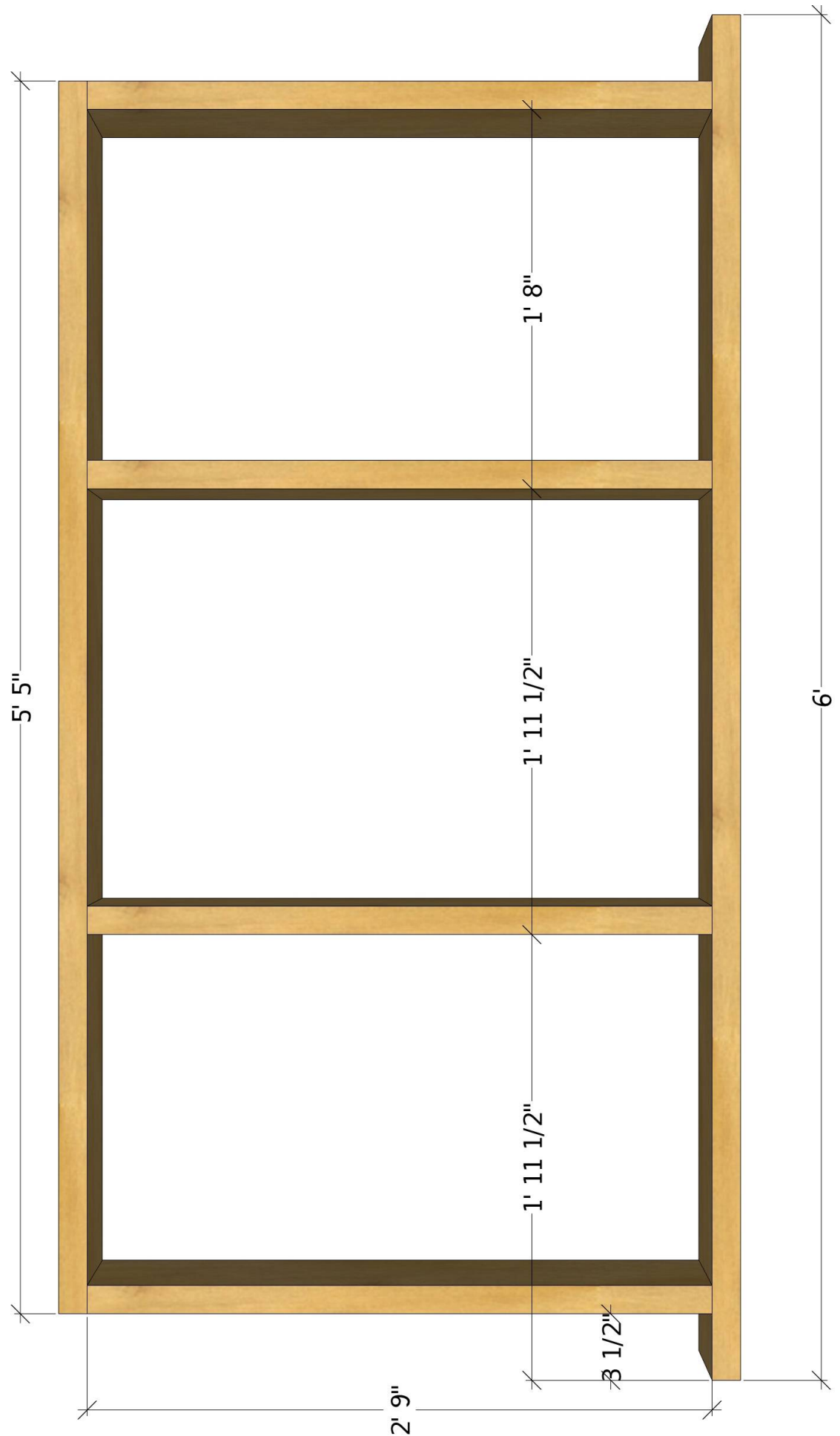



From (1) 4x4x10, cut and install the two 4' 10 1/2" pieces to the previous unit as depicted in the below illustration.

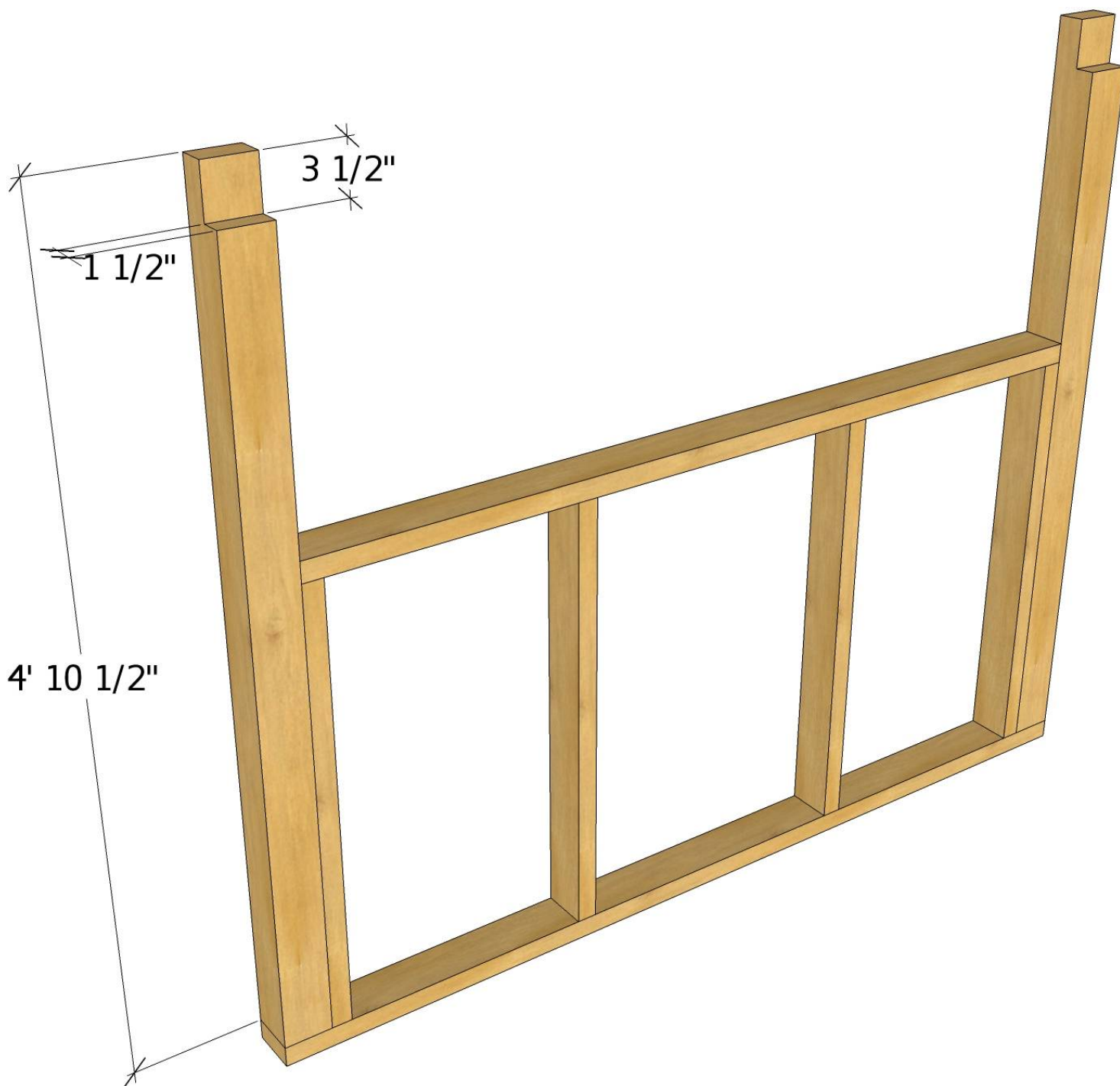

From (1) 2x4x12, cut two 6' pieces and install them to the top of the 4x4s as depicted in the below illustration.



# 2

## Framing the Front Wall

Repeat the instructions from step 1 for the front wall, except use (2) 4x4x8s for two 6' 4 1/2" pieces, instead of the two 4' 10 1/2" pieces. See the below illustration for details.

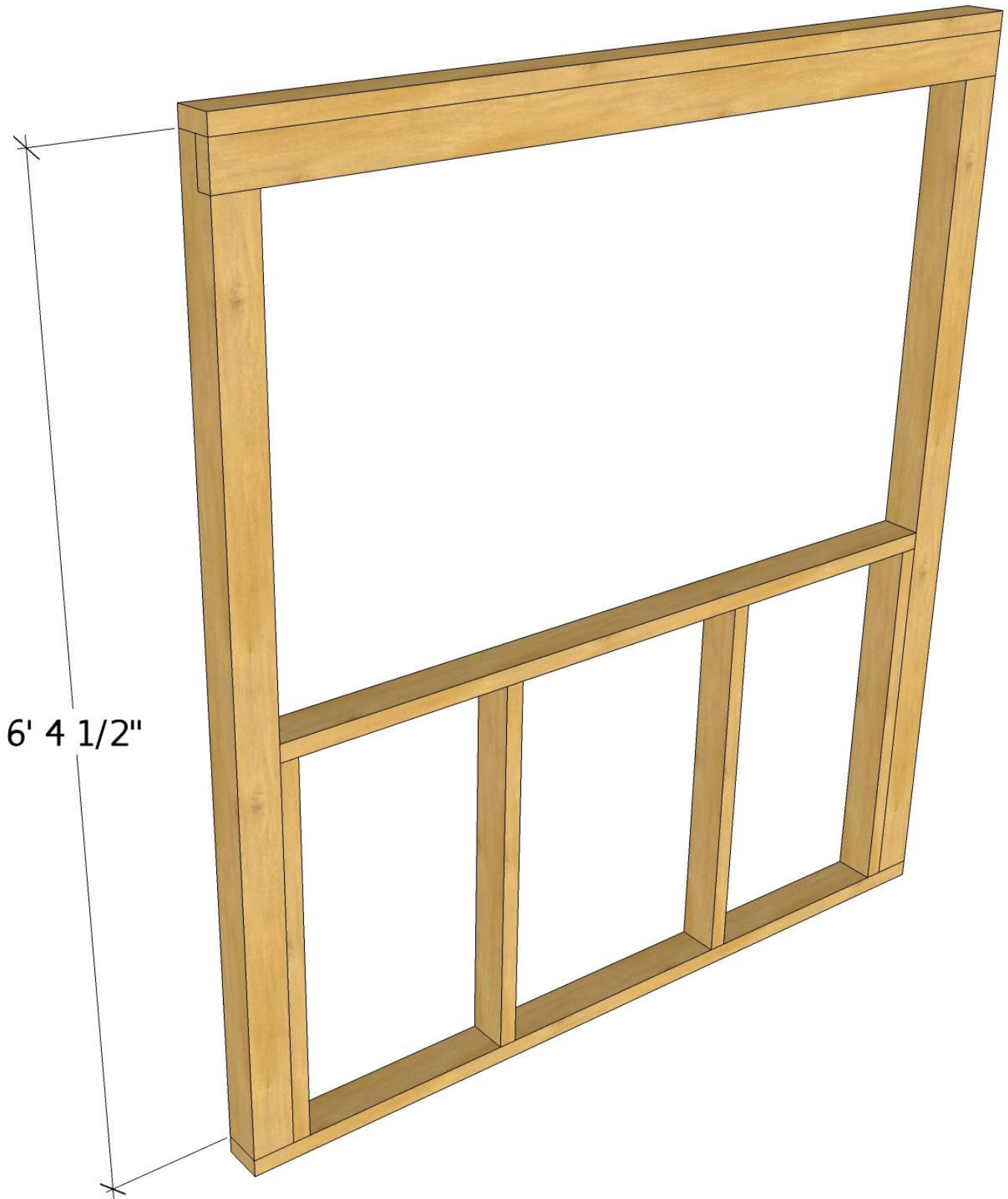

# 3

## Framing the Side Walls

From (1) 2x4x12, cut two 5' 5" pieces. From (1) 2x4x12, cut four 2' 9" pieces. Assemble these pieces into the wall shown in the below illustration.

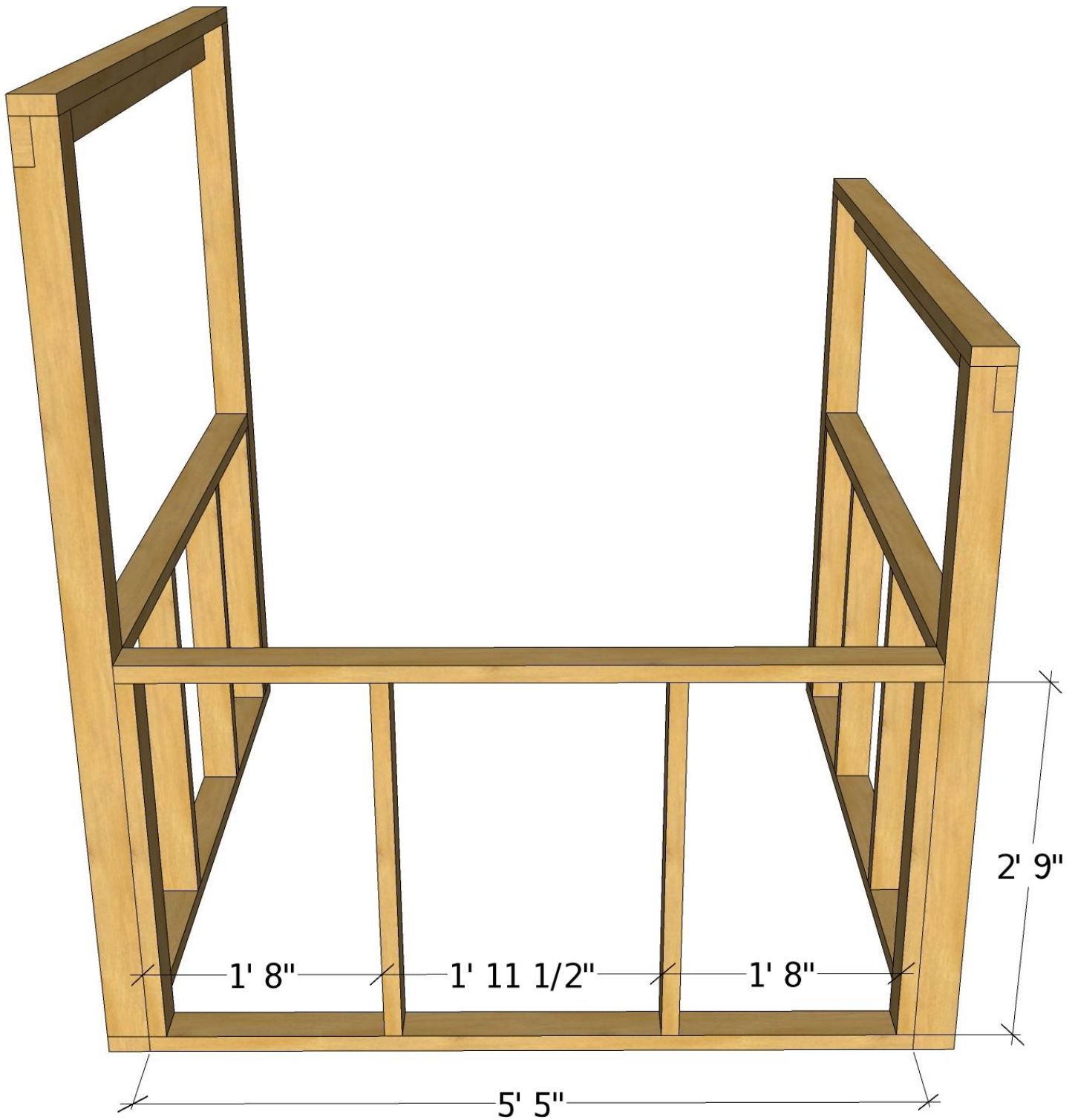



From (1) 2x4x10, cut one 5' 5" piece and two 1' 9 1/2" pieces. From (1) 2x4x12, cut four 2' 9" pieces. Assemble these pieces into the wall shown in the below illustration.

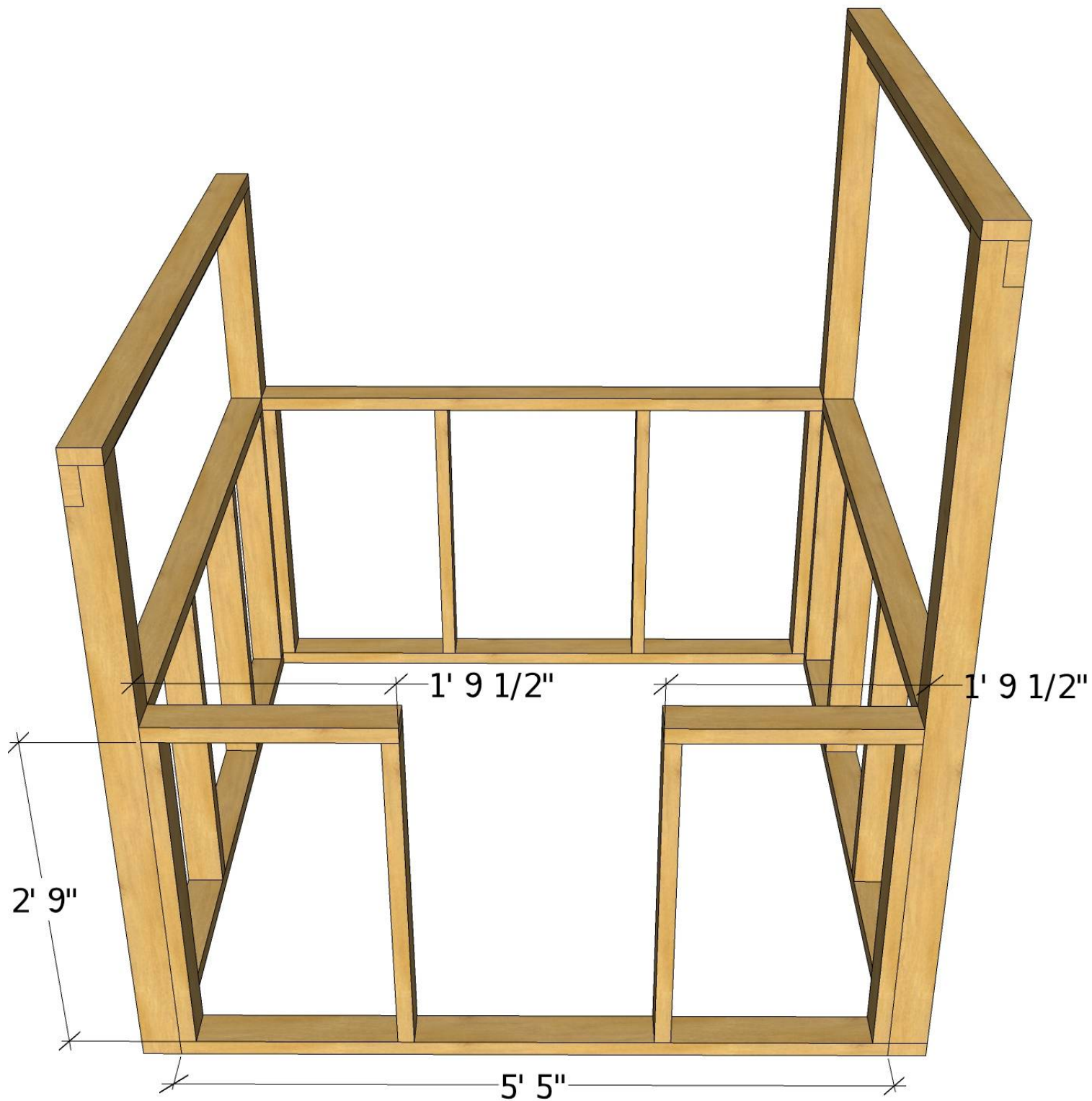

# 4

## Installing the Siding

From (9) 12' decking boards, cut eighteen 6' pieces. From (3) 10' decking boards, cut twelve 2' 1" pieces. Install these pieces to the four walls of the playhouse as depicted in the below illustration. Space the boards  $\frac{1}{2}$ " apart from each other.

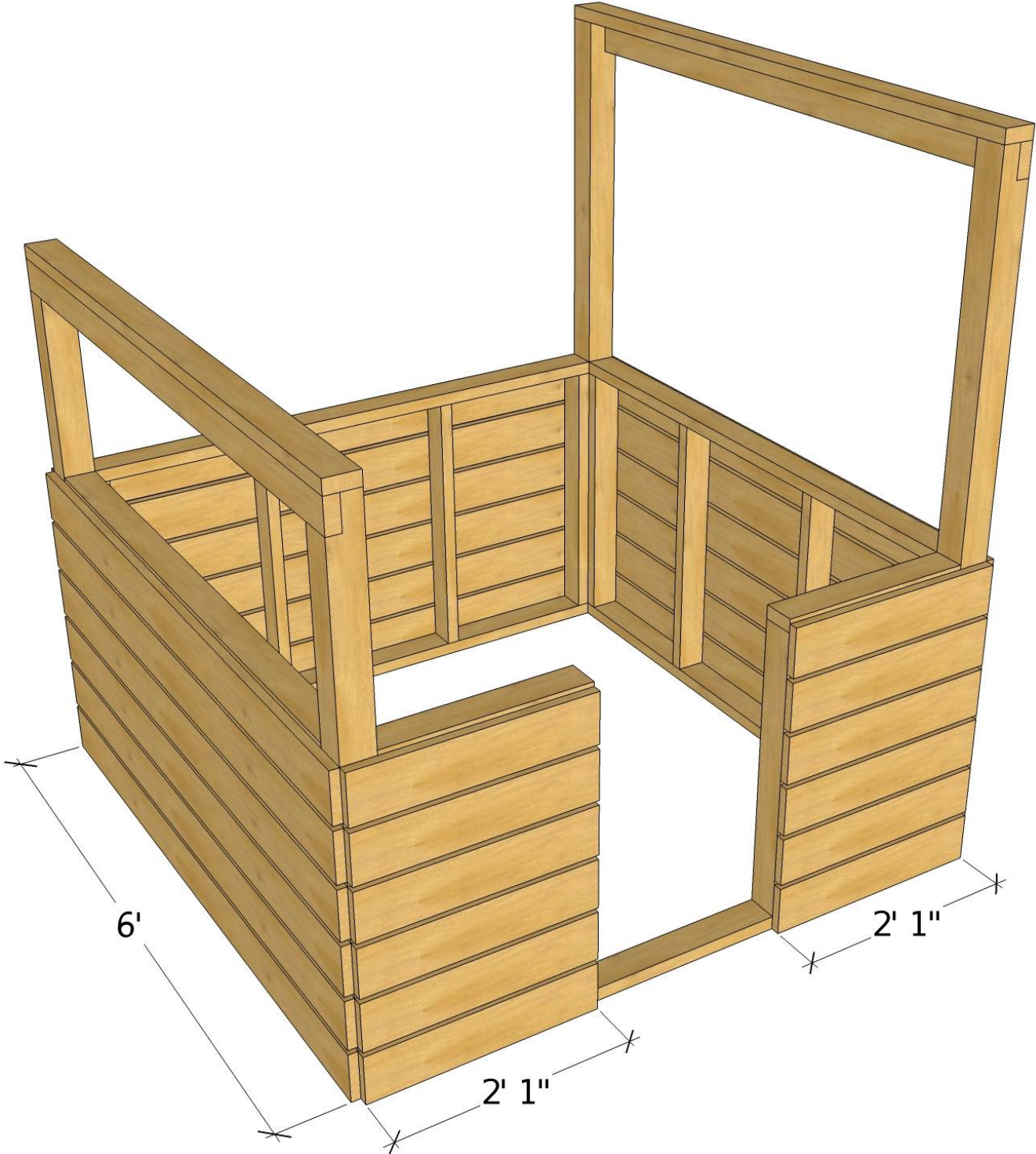

# 5

## Cutting & Installing the Rafters

From (6) 2x6x8s, cut six of the rafter depicted in the right illustration. The below illustration is a close up of the bird's mouth. Install these six rafters to the top of the play-set as depicted in the bottom illustration.

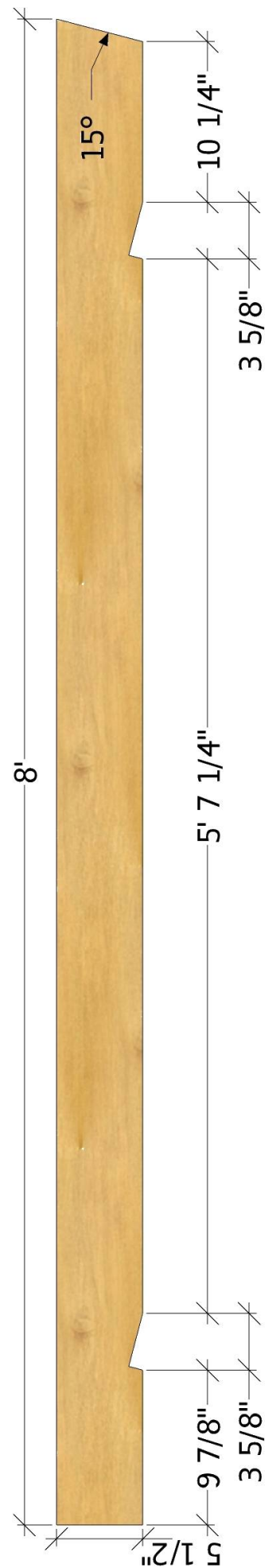
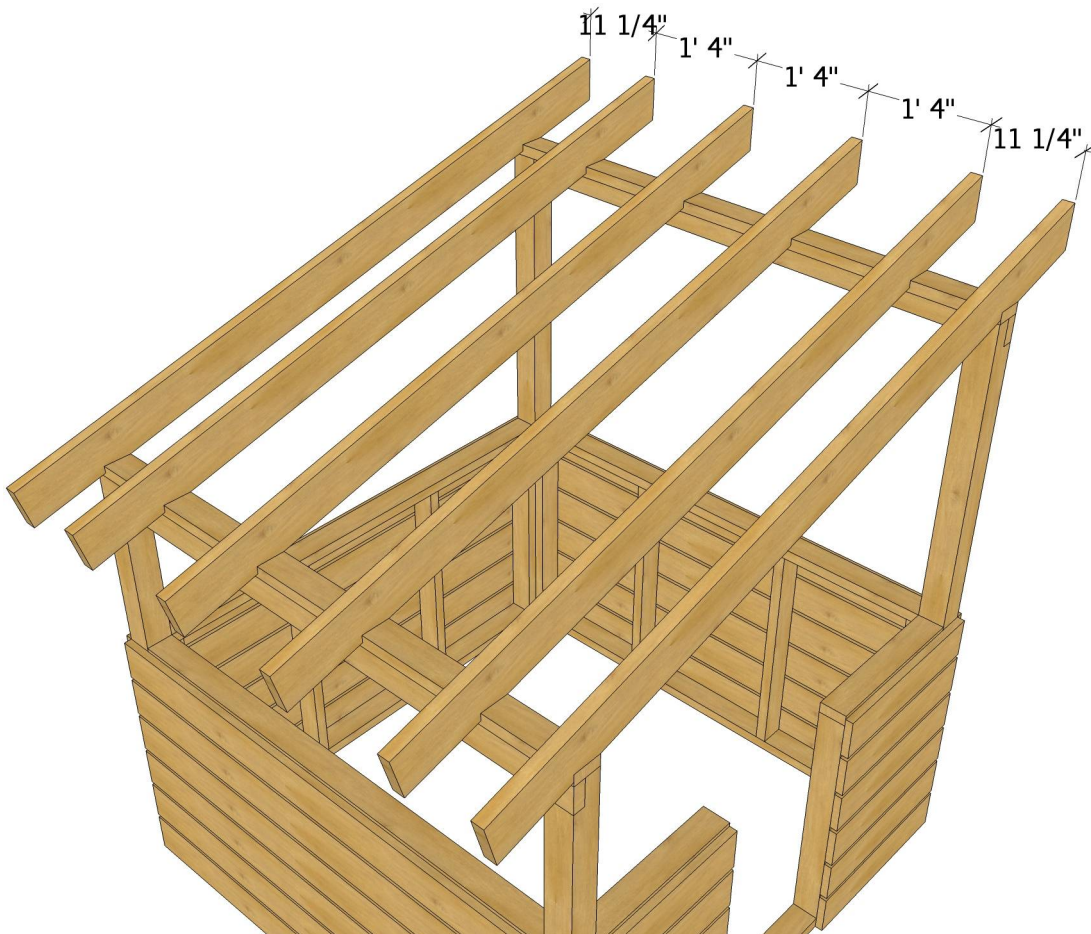
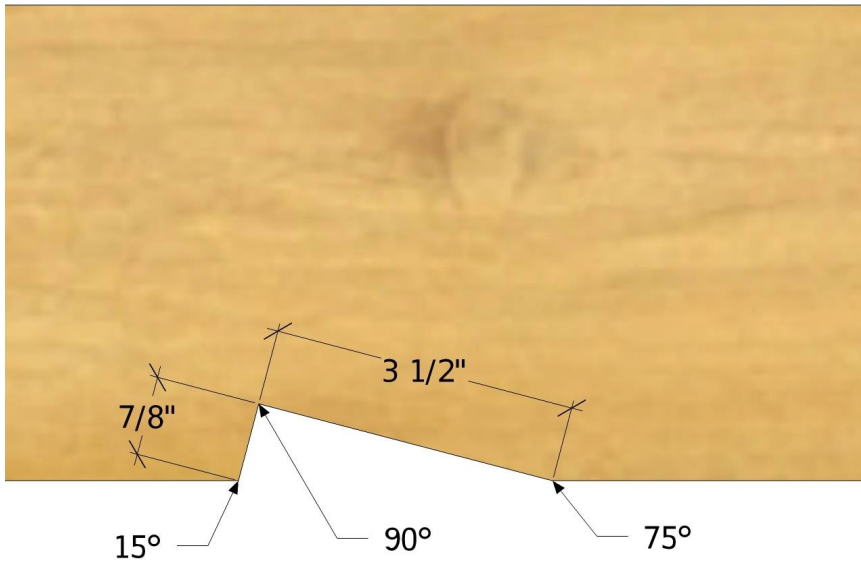



# 6

## Roof Sheeting

From (2) sheets of  $\frac{1}{2}$ " plywood, cover the top of the rafters as depicted in the below illustration.

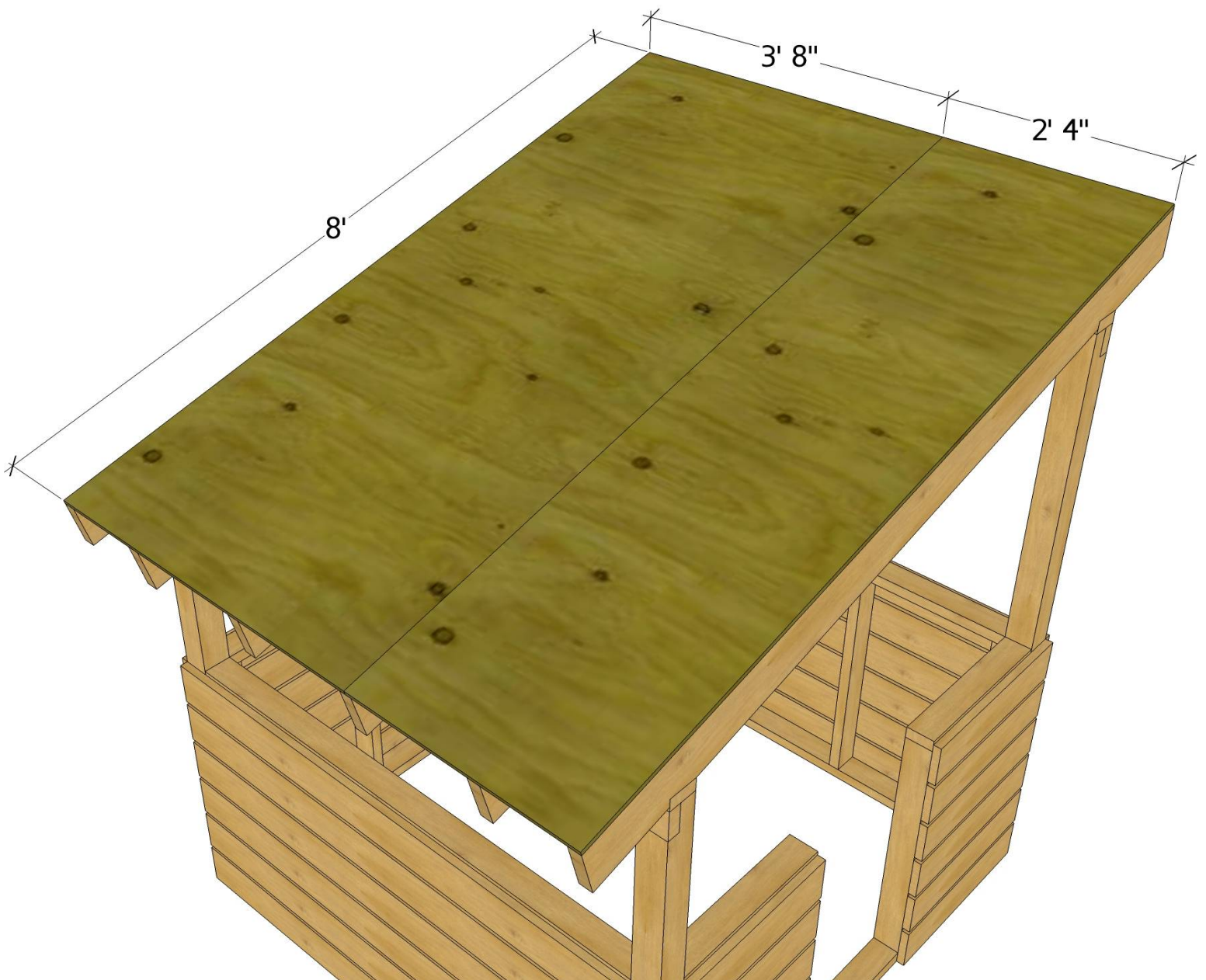

# B

## Best Selling Plans



[Barn & Silo Playhouse Plan](#)



[Happy Camper Play-set Plan](#)

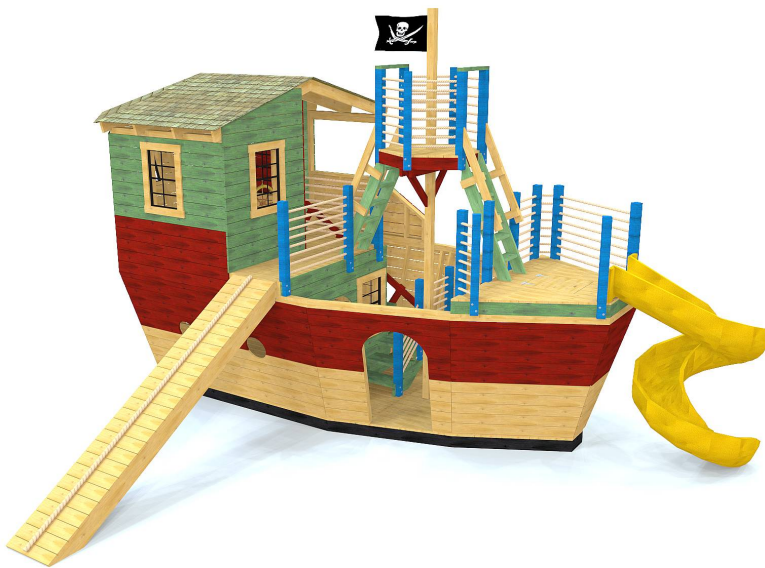

[Davy Jones' Locker Pirate ship Plan](#)



[Playground Playhouse Plan](#)





Paul's Clubhouse Plan



O'Connor Play-set Plan



King Author's Castle Play-set Plan



Randy's Ranch Playhouse Plan