



👁 Note!

Please note that this image is a general representation of the product and may differ slightly from your product.

👁 Note!

Please note that during storage and transport, especially at high ambient temperature, some of the oil and grease used for assembly may leak and stain the packaging. This is in no way detrimental to the product, wipe off the excessive oil or grease with a cloth.

⚠ Warning!

Before installing this product, read the Öhlins Owner's manual. The strut/shock absorber is an important part of your vehicle and will effect the stability.

Shock absorber for Porsche 911 Carrera (996)

POZ M100

Mounting Instructions

KIT CONTENTS

Front	
Description	Pcs
ABS cord bracket	2
Dust boot	2
Lock nut M14	2
Lock ring	(4)*
Shock absorber	2
Spring	(2)*
Spring platform	(2)*

Rear	
Description	Pcs
Adjuster	(2)*
Bump rubber	(2)*
Dust boot	2
Elastic spacer	2
Lock nut M12	2
Lock ring	(4)*
Plastic Spacer	2
Screw M6	4
Shock absorber	2
Spacer	2
Spring	2
Spring platform	(2)*
Stabilizer bracket	2
Stop washer	(2)*
Upper spring seat	2
Washer	2

Used for both front and rear	
Description	Pcs
C-spanner	1
C-spanner	1
Owners's manual	1
Sticker set R&T	1

* Parts are mounted on the damper at delivery.

MOUNTING INSTRUCTIONS

⚠ Warning!

We strongly recommend to let an Öhlins dealer install this product.

⚠ Warning!

If you work with a lifted vehicle, make sure that it is safely supported to prevent it from tipping over.

👁 Note!

When you work with this product, see the vehicle service manual for vehicle specific procedures and important data.

👁 Note!

Before you install this product check the contents of the kit. If anything is missing, please contact an Öhlins dealer.

MOUNTING INSTRUCTIONS

1

Front and rear:

Remove the original shock absorbers from the vehicle, see the vehicle service manual for correct procedure.

2

Front:

Remove the:

- top washer
- top mount
- bearing
- rubber insulator
- lower washer

from the original strut. Note that you will need these parts to install the Öhlins strut.

Rear:

Remove the:

- top washer
- top mount
- lower washer

from the original damper. Note that you will need these parts to install the Öhlins shock absorber.

👁 Note!

See the vehicle service manual on how to remove the parts.

⚠ Warning!

The spring is preloaded so take precaution when you remove the spring from the damper.

3 Front and rear

Cut the dust boot:

Front: 62 mm from the lower end.

Rear: 82 mm from the lower end.

4 Front and rear

Assemble the strut/shock absorber, see figures F4 (front) and R4 (rear).

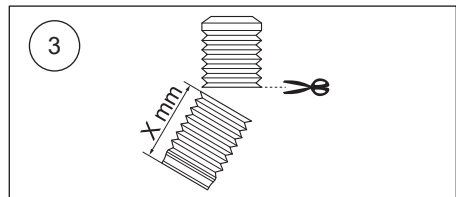

MOUNTING INSTRUCTIONS

F4

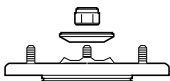

Lock nut M14
Original washer
Original top mount

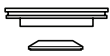

Original bearing
Original washer

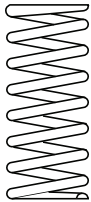

Spring

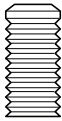

Dust boot

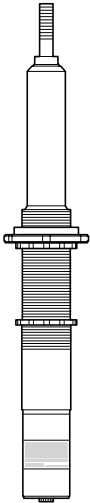

Shock absorber

Spring platform
Lock ring

Lock ring



ABS cord bracket

R4

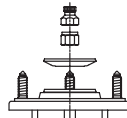

Adjuster
Lock nut M12
Original washer

Original top mount

Upper spring seat

Elastic spacer
Original washer
Washer



Spring

Plastic spacer

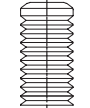

Dust boot



Stop washer
Bump rubber

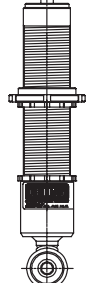

Shock absorber

Spring platform
Lock ring

Lock ring



Stabilizer bracket
Screw M6 (2x)

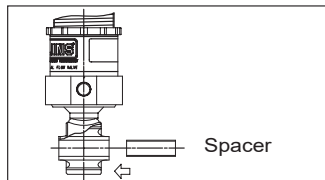

Spacer

MOUNTING INSTRUCTIONS

5

Front and rear:

Set the installation dimensions according to fig F5 and R5. You may need to change these to reach the target height.

👁 **Note!**

After you have installed all shock absorbers/struts you must check and adjust height. See section Adjustments and Setup data.

F5

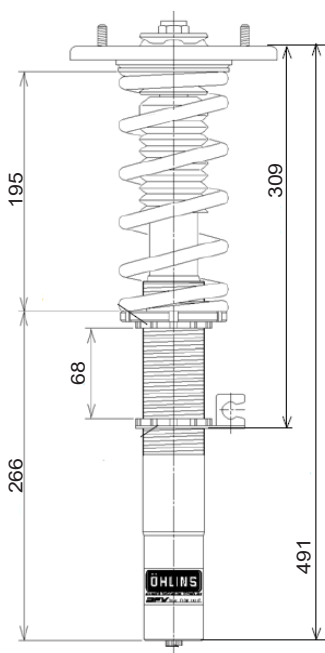

The diagram shows a side view of the F5 shock absorber. It features a coil spring at the top, a shock absorber body with a lock ring, and a lower spring seat. Dimensions are indicated with vertical lines and arrows: 195 (total height), 309 (height from top plate to lower spring seat), 68 (height of the lower spring seat), 266 (height from lower spring seat to bottom), and 491 (total height from top plate to bottom).

Tighten:
Lower spring seat and lock ring: 50-60 Nm
Lock nut M14: 35-40 Nm

👁 **Note!**
When you tighten the top mount nut, hold the strut top pin in position with a 6 mm Allen key

R5

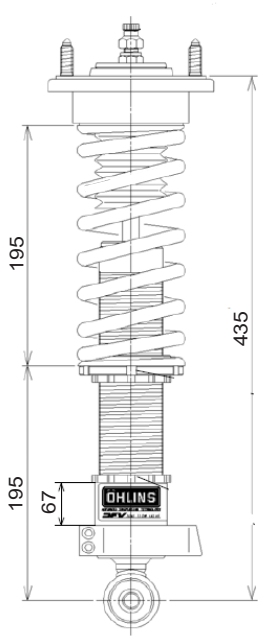

The diagram shows a side view of the R5 shock absorber. It features a coil spring at the top, a shock absorber body with a lock ring, and a lower spring seat. Dimensions are indicated with vertical lines and arrows: 195 (total height), 435 (height from top plate to bottom), and 67 (height of the lower spring seat). The Ohlins logo is visible on the lower part of the shock absorber body.

Tighten:
Lower spring seat and lock ring: 50-60 Nm
Lock nut M12: 30-35Nm
Anti roll bar bracket screw M6: 12-15 Nm

👁 **Note!**
When you tighten the top mount nut, hold the shock absorber shaft in position with a flat screwdriver.

MOUNTING INSTRUCTIONS

6

Front:

Install the Öhlins strut on the vehicle according to the vehicle service manual.

Rear:

Install the Öhlins shock absorber on the vehicle according to the vehicle service manual.

⚠ Caution!

Ensure that all screws are tightened to the correct torque and that nothing fouls or restricts movement of the strut/shock absorber when the suspension is fully compressed or extended.

👁 Note!

Make sure that all removed parts, except the replaced parts, are reinstalled in the same positions as they were before the installation of the Öhlins shock absorbers.

7

Rear:

Position the anti roll bar bracket according to figure R7.

8

Rear:

If the car is equipped with the BOSE loud speaker system you will need a wire adjuster.

Part numbers:

24631-01 (1 pc/side)

24632-01 (1 pc/side)

24633-01 (1 pc/side)

24633-02 (1 pc/side)

👁 Note!

Parts for step 8 need to be ordered separately.

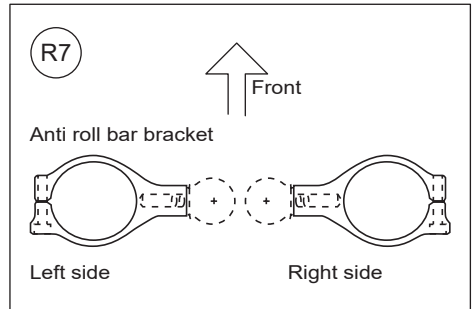

ADJUSTMENTS

⚠ Warning!

Before you drive, always make sure that the setup is according to the recommended setup data. Read about adjustments and setting up in the Öhlins Owner's Manual before you make any adjustments. Contact an Öhlins dealer if you have any questions about setting up.

👁 Note!

All dimensions are applicable for vehicles with original wheel dimensions.

Set vehicle height

When the Öhlins dampers are setup according to figures F5 and R5 and installed on the vehicle we recommend to set the height. Below is a short description on how to setup the target height of the car and what the limits for adjustment are:

Definitions:

- A; Highest point on fender to ground.
- B; Highest point on fender to center of wheel.
- B'; Highest point of fender to lower edge of rim.
- D; Diameter of rim (measured)

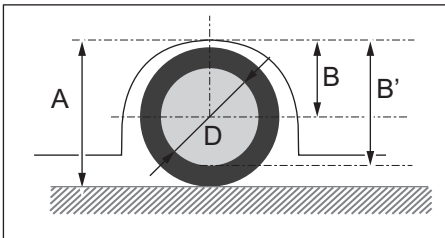

Actual vehicle height:

The target height (B) for your vehicle with the Öhlins dampers installed is:

- front: 330 mm
- rear: 335 mm

To calculate target height (B):

1. Measure the rim (D).
2. Measure from the lowest point of the fender to the lowest edge of the rim and deduct half the diameter of the rim (D).

$$B = B' - D/2$$

If the height needs to be adjusted to reach the target height, change the length of the damper with the lower lock ring on the front damper and by moving the golden cup on the rear damper.

👁 Note!

Do not adjust outside the recommended range. Tighten to the specified torque after you have adjusted.

SETUP DATA

Adjuster settings		
Track use	0-7	clicks
Winding road	5-10	clicks
Street	10-20	clicks
Spring		
Free length	197-203	mm
Spring rate	Front 60 N/mm	
	Rear 120 N/mm	
Preload	5	mm

To calculate installed spring length:

Free length of the spring - Spring preload (see table) = Installed spring length

Vehicle height

Set the vehicle height with the dampers installed on the vehicle. See instructions in the Owner's Manual.

Adjust the length of the front strut in the range:

+10 from the reference length (to raise)

-10 from the reference length (to lower)

Adjust the length of the rear shock absorber in the range:

+10 from the reference length (to raise)

-10 from the reference length (to lower)

Öhlins products are subject to continuous improvement and development, therefore, although these instructions include the most up-to-date information available at the time of printing, minor updates may occur.

To find the latest information contact an Öhlins distributor. Please contact Öhlins if you have any questions regarding the contents in this document.

Part no. MI_POZMI00_1
Issued 2015-05-25

© Öhlins Racing AB. All rights reserved. Any reprinting or unauthorized use without the written permission of Öhlins Racing AB is prohibited.

Öhlins Racing AB
Box 722
S-194 27 Upplands Väsby, Sweden
Phone +46 8 590 025 00
fax +46 8 590 025 80



www.ohlins.com