

VIOLECTRIC

HEADPHONE AMPLIFIER

Violetric HPA V550 / V550 PRO



USER'S MANUAL

Content

Theme	Page
About VIOELECTRIC	4
Safety Instructions	5
The Earth / Grounding Concept	6
Connection / Connectors	8
General	9
Remote Control	11
Block Circuitry	12
Power Inputs, Controls	13
About PRE-GAIN	15
Outputs / Output Management	17
Reset	20
Software	21
Things to know	21
Disposal	24
Technical Data	25
Dismantling	26
Jumper Settings	27
Conformity Statement	28
Warranty	29

CAUTION!!

**THE HIGH OUTPUT LEVELS ACHIEVABLE
WITH THIS UNIT MAY
DAMAGE YOUR HEARING OR THE HEADPHONES
IF OPERATED CARELESSLY!!**

Cordial thanks for your decision in favour of a **VIOLECTRIC product!**

VIOLECTRIC is a trademark and product line of Lake People electronic GmbH. Lake People electronic GmbH develops, manufactures and distributes products in the professional range, for broadcast, television, airports, exhibition halls, festival venues, theatres, large-scale installations, private studios and more. In the private sector as well, Lake People products become increasingly popular due to their outstanding quality.

The trademark and product line **VIOLECTRIC** is specially intended to supply the Hi-Fi and High-End market with its specific requirements.

Who develops **VIOLECTRIC equipment?**

The devices are exclusively developed in Germany by the engineers of Lake People electronic GmbH. In doing so, the team of developers can draw on over thirty years of experience and countless products for the pro-audio domain.

Among others, the first German-made 20-Bit A/D and D/A converters were developed by Lake People in the early nineties of the past century.

Who manufactures **VIOLECTRIC equipment?**

The devices are exclusively manufactured in Germany by Lake People electronic GmbH or contractors in the company's vicinity.

Lake People - and by association **VIOLECTRIC** - put high emphasis on domestic manufacturing. As well, all component suppliers are chosen in order to achieve the main part of added value inland.

How do **VIOLECTRIC devices get to the customer?**

The devices can be obtained from respective specialist suppliers. If there is none such accessible regionally, the customer is supported by transregional distribution partners (google may help...) and, of course, by **VIOLECTRIC** on-line shop.

... and if it doesn't work like it should?

VIOLECTRIC devices are covered by a 5-years warranty. In case of any malfunction during this period, they can be shipped to the manufacturer directly. Of course, the client will benefit from the full technical support even when warranty has expired. Any technical questions or need for advice is welcome.

VIOLECTRIC is a subsidiary of



LAKE PEOPLE electronic GmbH
Turmstrasse 7a
D-78467 Konstanz

Fon +49 (0) 7531 73678
Fax +49 (0) 7531 74998

www.lake-people.de
www.lake-people.com
www.NIIMBUS-audio.de
www.NIIMBUS-audio.com
www.vioelectric.de
www.vioelectric.com

WARNING

For your protection, please read the following:

Water, Liquids, Moisture:

This appliance should not be used near water or other sources of liquids.

Care should be taken so that objects do not fall and liquids are not spilled into the enclosure through openings.

Power Sources:

The appliance should be connected to a power supply only of the type described in the operating instructions or as marked on the appliance.

Grounding:

Care should be taken that this appliance is operated with proper grounding only.

Power Cord:

Power supply cords should be routed so that they are not likely to be walked on or pinched by items placed upon or against them, paying particular attention to cords at plugs, convenience receptacles, and the point where they exit from the appliance.

This unit is equipped with a 3-pole mains cable with German 3-pin mains plug.

In some countries this unit must be operated with a mains adaptor, supplied by the owner.

Please refer to the table below to connect a mains plug:

OVERVIEW: POWER CORD FUNCTION AND COLORS			
CONDUCTOR		COLOR	Alternativ
L	LIVE	BROWN	BLACK
N	NEUTRAL	BLUE	WHITE
E 	PROTECTIVE EARTH	GREEN+YELLOW	GREEN

U.K. Mains Plug Warning:

A moulded mains plug that has been cut off from the cord is unsafe.

Discard the mains plug at a suitable disposal facility.

NEVER UNDER ANY CIRCUMSTANCES SHOULD YOU INSERT A DAMAGED OR CUT MAINS PLUG INTO A 13 AMP POWER SOCKET.

Do not use the mains plug without the fuse cover in place.

Replacement fuse covers can be obtained from your local retailer.

Replacement fuses are 13 amps and MUST be ASTA approved to BS 1362.

Mains Fuse:

The mains fuse of this appliance is soldered in place and accessible from the inside only!!

A blown fuse may indicate an internal problem and should be replaced during qualified servicing or repair work!

Switchable Power Supply:

Connect this unit to the power source indicated on the equipment rear panel only to ensure safe operation!

This unit is provided with an internally settable mains supply for 230 or 115 V AC.

Service / Repair:

To reduce the risk of fire or electric shock, the user should not attempt to service the appliance beyond the measures described in the operating manual. All other servicing or repair should be referred to qualified personnel!

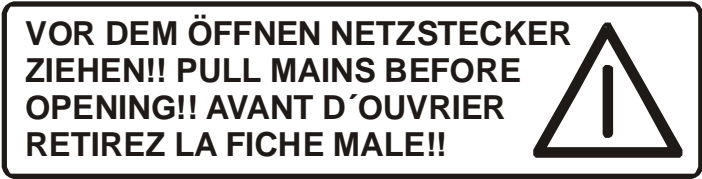

Electromagnetic Compatibility

This unit conforms to the Product Specifications noted as **Declaration of Conformity** at the end of this manual. Operation is subject to the following conditions:

- this device may not cause harmful interferences
- this device must accept any interference received, including interference that may cause undesired operation
- this device must not be operated within significant electromagnetic field

The Earth / Grounding Concept

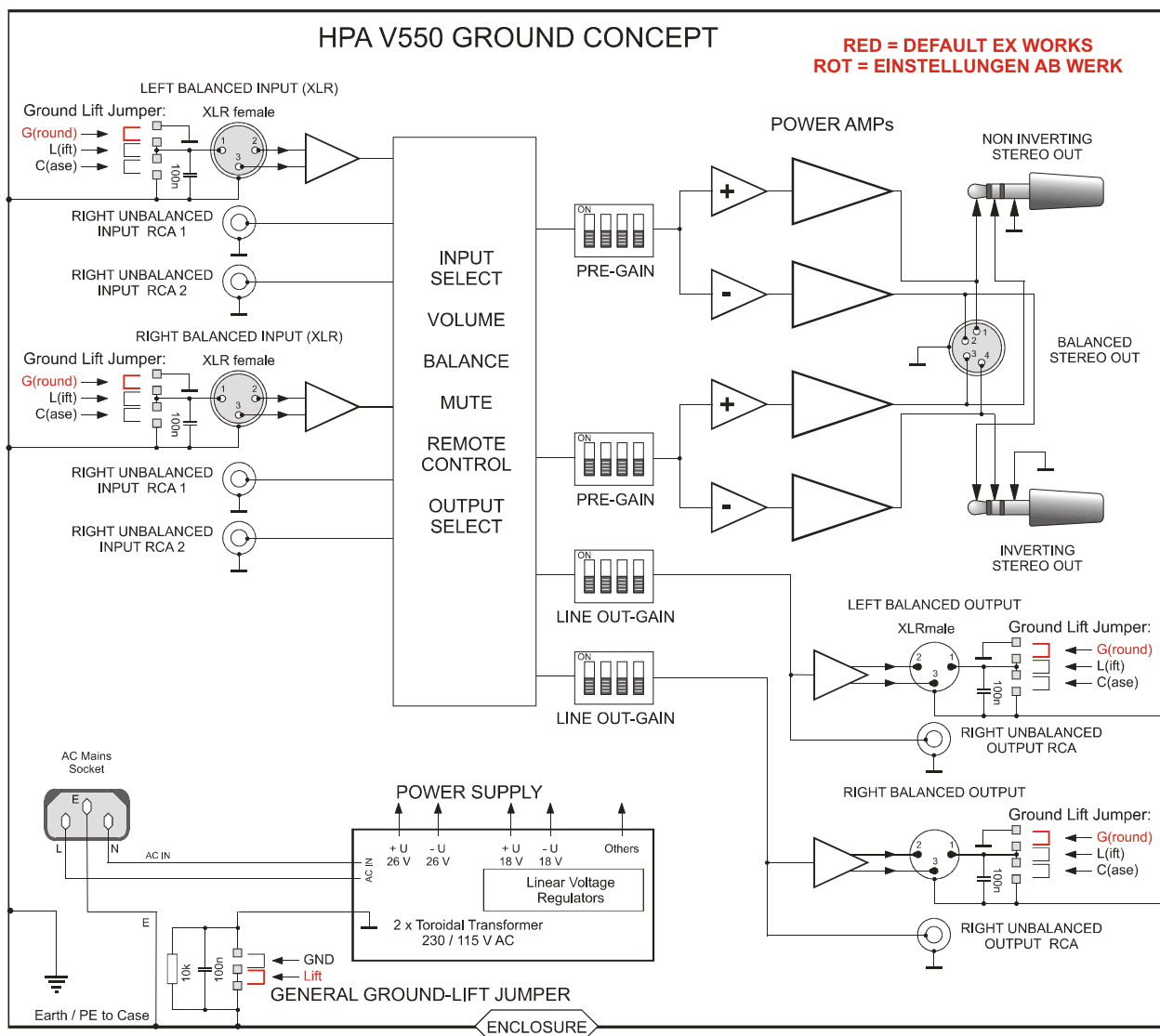

General GROUND-LIFT Jumper

(Accessible from the inside. Mind the SECURITY INSTRUCTIONS):

Ex-works this jumper is set to the **LIFT** position.

The internal ground potential is "lifted" by means of this jumper.

As a result, the interconnection for DC voltages and lower frequencies (< 150 Hz) will be cut.

Higher frequencies will be bled off to earth potential through the RC filter. The LIFT position is helpful in case of hum or jitter caused by different ground/earth potentials. Of course, full electrical protection is granted as the case is always connected to ground/earth potential!

See page 31 "Jumper Settings" for details.

Unfortunately, there is no general recommendation how to solve hum and jitter problems - or even minimize them. The best way to succeed is to check different options! In case of balanced cables, it should always be verified if the shield of the cable is connected to the shell of the XLR connector. The shell is ALWAYS connected to earth potential when the connector is inserted!

Concerning ANALOGUE inputs and outputs, the relationship between ground and earth may be modified. Electrical safety is always ensured since the earth conductor is permanently connected to the enclosure!

XLR GROUD-LIFT Jumper

(Accessible from the inside. Mind the SECURITY INSTRUCTIONS):

G(ROUND): Ex-works all jumpers are set to "**G**" (ground) position.

Pin 1 is connected to the internal ground reference.

High frequency interference is deflected to the case via a 100 nF capacitor.

L(IFTE): The interconnection between Pin 1 and ground is open. High frequency interference is deflected to the case via a 100 nF capacitor. This jumper position is specifically useful if the unit is equipped with audio-transformers!

C(ASE): Pin 1 is connected to the case, the 100 nF capacitor is bridged. This jumper position may be varied together with the **General GROUND-LIFT jumper**.

**Please note that with jumpers not in the ex-works position
EMC emission might occur,
for which the user is responsible only!
So, only change these settings when you know what you are doing!**

Connection / Connectors for Analogue Signals

ANALOG SIGNALS

Balanced Cable (Signal) to Balanced Input

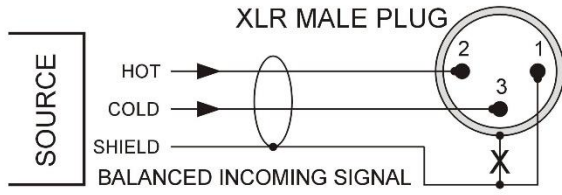

Shield = Signal Ground = Pin 1
 Hot / + Phase = Pin 2
 Cold / - Phase = Pin 3
 The case of the connector should not be wired to the shield of the cable. The connector is routed to earth potential (PE) when plugged into the corresponding socket of the case !

ANALOG SIGNALS

Unbalanced Cable (Signal) to Balanced Input

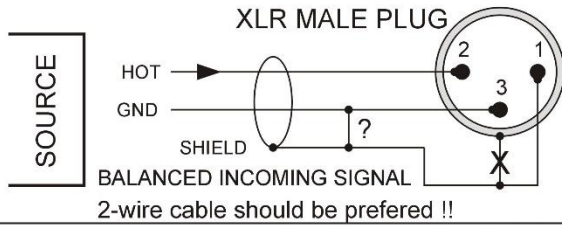

Shield = Signal Ground = Pin 1
 Hot / Signal = Pin 2
 Cold / Ground = Pin 3
 The case of the connector should not be wired to the shield of the cable. The connector is routed to earth potential (PE) when plugged into the corresponding socket of the case !

ANALOG SIGNALS

Unbalanced Input / Output to Unbalanced Cable

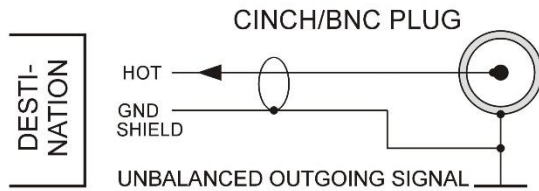
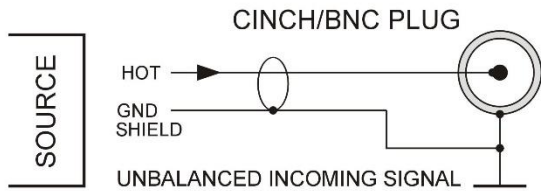

ANALOG SIGNALS

Balanced Output to Balanced Cable

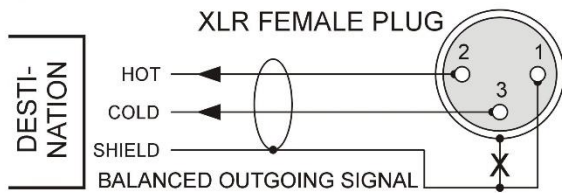

Shield = Signal Ground = Pin 1
 Hot / + Phase = Pin 2
 Cold / - Phase = Pin 3
 The case of the connector should not be wired to the shield of the cable. The connector is routed to earth potential (PE) when plugged into the corresponding socket of the case !

UNBALANCED HEADPHONE SIGNALS 6.3 mm (1/4") TRS Phone Jack (Tip - Ring - Sleeve Connector)

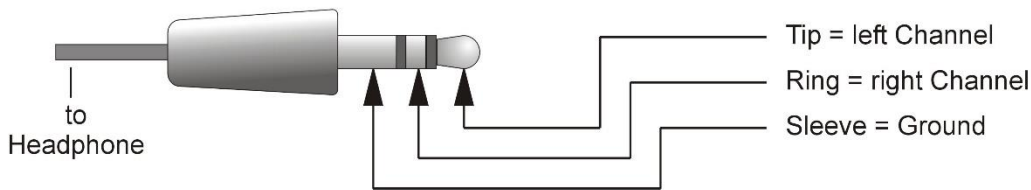

BALANCED HEADPHONE SIGNALS

4-pin XLR Connector (female on the device)



GENERAL INFORMATION

VIOLECTRIC HPA V550 contains a first-class **Preamplifier** and a high-grade stereo **balanced Headphone Amplifier** designed to drive low-, medium- and high-Z loads (16...600 ohms) as usually represented by high-quality headphones.

Because of its four built-in amplifiers and the front mounted 4-pin XLR socket it is a real balanced amplifier. V550 carries its four-pin socket advisably and not to pretend a balanced action. It is not only a convenience feature !

Due to its specific, highly variable, low-noise and low distortion circuit design especially optimised for dynamic and orthodynamic headphones, HPA V550 fulfils even highest demands.

Features HPA V550:

- **3 analogue stereo inputs**, input impedance 10 kOhm, max. level +21 dBu
 - 1 x balanced via Neutrik XLR, gold plated
 - 2 x unbalanced via RCA sockets, gold plated
- All inputs switchable from the front
- LEDs for the activated input
- **PRE-GAIN** = sevenfold gain/attenuation -18 / -12 / -6 / 0 / +6 / +12 / +18 dB
- **Headphone amp with 4 discrete-design power amps with 16 transistors per channel**
- Extremely low output impedance
- 1 x 4-pin XLR connector, Neutrik, gold plated
- 2 x TRS phone jacks, Neutrik, silver plated
- Balanced and unbalanced line outputs via XLR and RCA connectors, gold plated
- Line outputs pre/post (fixed/variable = w/o volume control) switchable
- Line output level with sevenfold gain/attenuation -18 / -12 / -6 / 0 / +6 / +12 / +18 dB
- Alps RK 27 motorized volume control
- Alps RK 27 balance control
- **Output management:** headphones active / line-out active / both active / none active (mute)
- LEDs to display the activated outputs
- **Remote control** for volume, input selection, output selection, mute
- 52 transistors, 24 High Quality Audio Op-Amps in the signal path
- High-grade MKP capacitors in the signal path
- 0,1 % und 1 % Metallfilm resistors
- Large filter capacity (> 35.000 uF)
- delayed relay-based headphone output during power on / instant cut-off for power off
- **Protective circuits** for overload, DC, temperature
- 2 x toroidal transformers 25 + 25 W
- Rugged Aluminum case, black anodized
- 8 mm massive Aluminum front panel

Features HPA V550:

- Motorized volume control, reed relay attenuator with 256 steps of 0,4 dB each

With its dimensions, the VIOLECTRIC HPA V550 ensures optimum flexibility combined with high output power. During design, high emphasis was put on operational safety even when the unit is operated inappropriately.

HPA V550 is equipped with safety circuitry and internal filters to prevent damage to the connected headphones due to DC voltages at the outputs, power overload and high-frequency overload beyond the audible range.

THE CASE

of VIOLECTRIC HPA V550 is made of 3 + 4 mm Aluminum and a thick 8 mm aluminum front panel. This choice of material ensures high mechanical stability and resistance whilst maintaining a high optical and haptic quality.



GROUND AND PROTECTIVE EARTH

The case of VIOLECTRIC HPA V550 is connected to protective earth.

POWER SUPPLY

Mains power is provided via a three-pin IEC/CEE socket and mating "cold-appliance" mains cord with Schuko-type plug for units purchased in middle Europe.

The device is set to 230V mains, whereas the actual voltage may vary between 190 and 240 volts for flawless operation.

The mains voltage may be altered to 115 V AC supply inside the unit with the aid of a mains voltage selector. In this case stable operation is granted in a range of 85 to 120 V (see page 27).

Two toroidal transformers each with 25 Watt are providing the internal operating voltages of +/-25 V. Out of these voltages some more operating voltages are generated.

MAINS FUSE

The time-lag fuse is soldered in place on the circuit board. In case, it must be replaced with a fuse of the same type only.

CAUTION!!

MIND THE SAFETY INSTRUCTIONS:

A blown fuse indicates an internal fault and should be replaced during qualified repair or servicing only!

THE REMOTE CONTROL FOR VIOLECTRIC HPA V550

Function

This remote control sends out infrared rays. For that purpose, there is an infrared LED on the front. The remote control should point in direction of the target device to obtain best functionality.

The operating distance is about 5 - 7 meters (15 - 20 ft).

With the "VOLUME +/-" buttons the volume can be altered. This is done with a motor inside the amp to get the volume knob into motion.

With the "MUTE" button the internal mute function is engaged.

A direct "MUTE" can only be released by the remote control.

With the "INPUT 1 / 2 / 3" buttons one of the three analogue inputs may be selected.

With the "Head-Output" and "Line-Output" buttons you may chose if the front mounted headphone outputs are active or the rear mounted line outputs - or both or none.

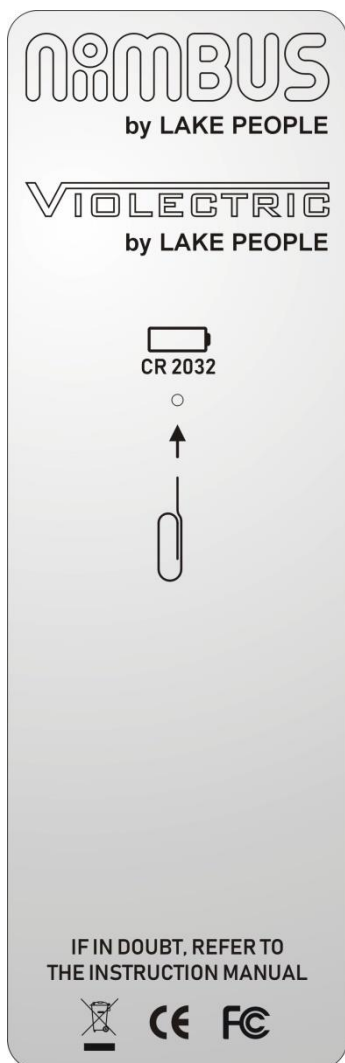
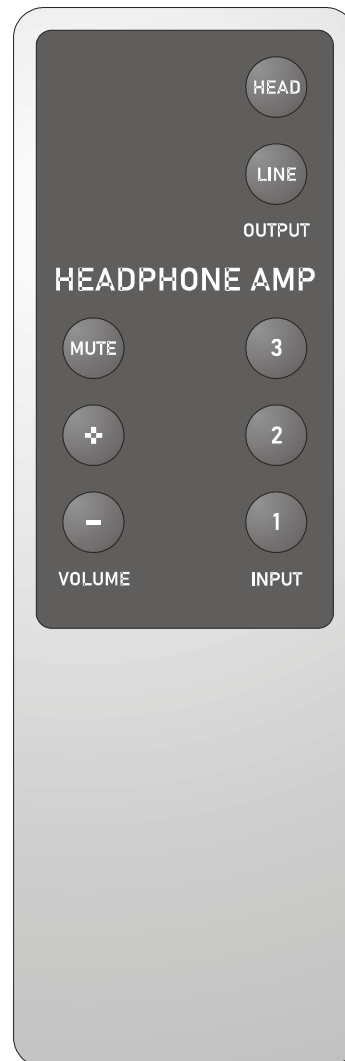

(pictures show the original size of the remote control)

Maintenance

The remote control is powered by a little "CR2032" size lithium battery. The battery diameter is 20 mm, the height is 3,2 mm - that's where the name comes from.

If you share the opinion that the battery is empty you may check this with the aid of your smartphone. The camera function reacts on the infrared rays of the remote control which cannot be seen with human eyes.

So, just point the remote control to the camera of your smart phone and press a button. When you don't see any action, the battery is empty.

Take a paperclip or something similar and bend it like indicated on the back of the remote control. Plug it in the little hole to force the keypad to come out the aluminum frame - it is held by magnets.

Now you can carefully take off the electronics to replace the battery.

The (-) pole must point to the PCB.

The (+) pole is the wider part and normally denoted.

It has to point "upwards".

Re-assemble the keypad, take care of the infrared LED !

VIOLECTRIC HPA V550 block circuitry

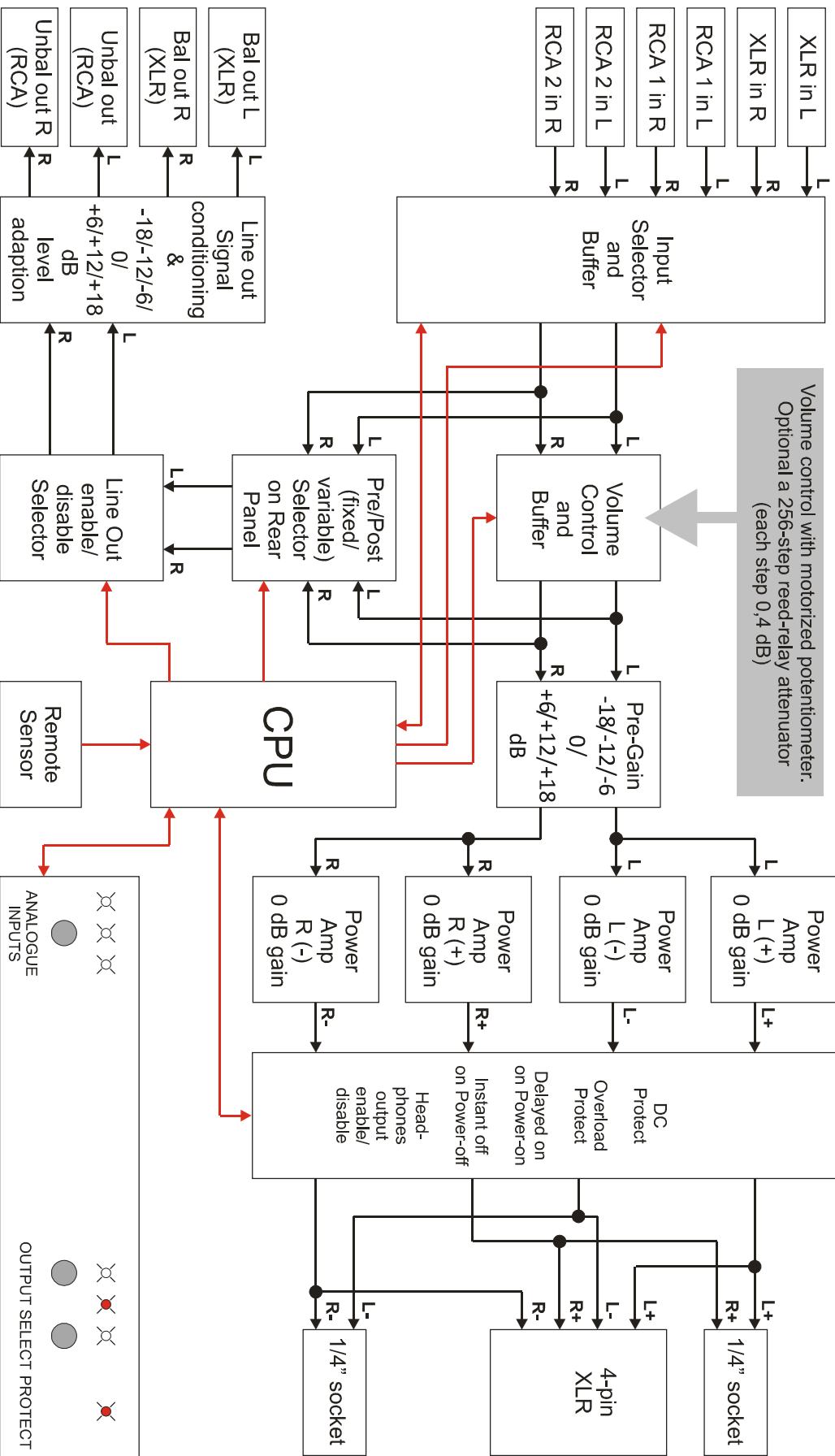

THE POWER-SWITCH



The unit is put into operation by means of the power switch. The power-on procedure takes about 5 seconds. During this time the "PROTECT" LED lights red until all internal parameter are checked and found OK. Any breakdown will cause the "PROTECT" LED to come up and the outputs are muted. HPA V550 will always start with the last settings of the input- and output configuration.

THE ANALOGUE SIGNAL INPUTS

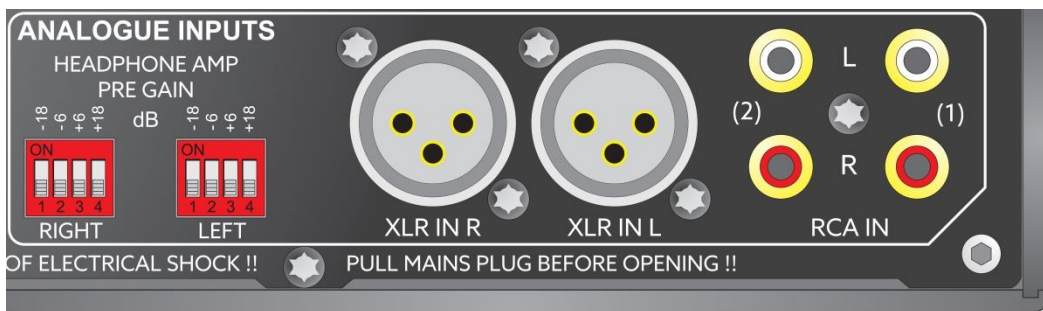

THE BALANCED SIGNAL INPUTS

are situated on the rear panel of the unit and are labelled as "XLR IN Left" and "XLR IN Right". They are fitted with gold plated XLR sockets from Neutrik.

Please note:

Unbalanced signals can be injected as well by means of an adaptor. See page 8 to learn more.

Balanced XLR pin-out:	
PIN 1	GND
PIN 2	(+) PHASE
PIN 3	(-) PHASE

THE UNBALANCED SIGNAL INPUTS

For the use with unbalanced signals, gold plated RCA sockets are provided. They are labelled as "RCA IN Left 1/2" and "RCA IN Right 1/2".

The input impedance on all analogue inputs is 10 kohms.

Maximum input level should not exceed +21 dBu.

It is reduced to +3 dBu when **PRE-GAIN** +18 dB is engaged.

HEADPHONE AMP PRE-GAIN

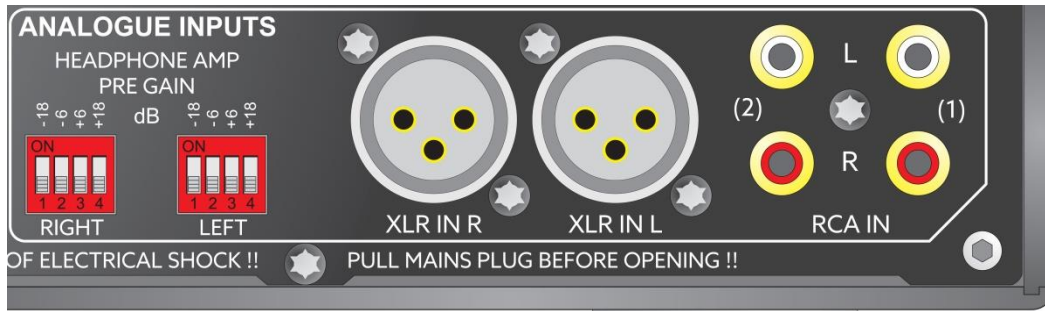

These DIP-switches are situated on the back of the unit inside the field of the analogue inputs. Settings can be made for the left and right channel - they shall not be different from each other. With these switches an additional gain or attenuation may be set. It is dependent on the output level of the input source and the sensitivity of the headphones connected. By this measure it is maintained to achieve lowest possible noise and maximum travel of the volume attenuator. The high gain/attenuation range of +/-18 dB (factor 64) ensures a perfect match of any source with any headphone in the market.

Please see page 15 to learn more about: "Too loud? Too soft? The PRE-GAIN method"

SELECTING / ACTIVATING AN INPUT

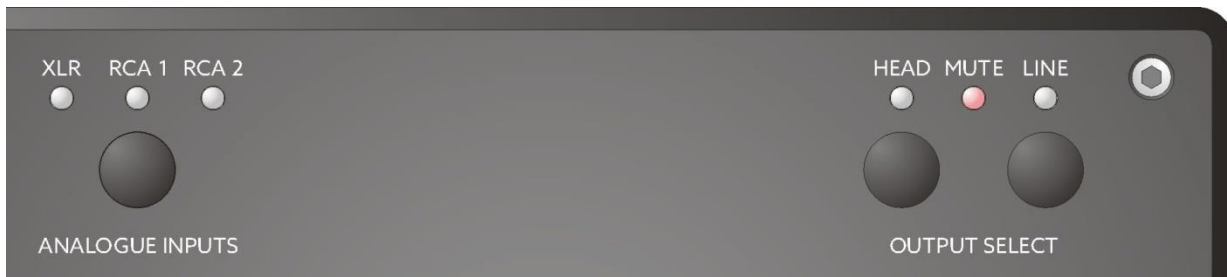

With the "ANALOGUE INPUTS" button on the front of VIOLECTRIC HPA V550 one of three analogue inputs may be activated. The corresponding LED is illuminated. You can also use the remote control for this purpose. Press the "INPUT 1 / 2 / 3" buttons to change the analogue inputs.

THE VOLUME ATTENUATOR



is to set the desired volume for the left and right channel simultaneously. Volume can also be set via your remote control by depressing the "VOLUME +/-" buttons. For this purpose, the volume control is actuated by a servo motor. Manual operation of the knob at the same time - although not useful - is possible without the risk of damage.

As an option (**HPA V550 PRO**), the attenuation is made in 256 steps of 0.4 dB each. The steps are switched with special "reed relays". Here, the switching contacts are situated in a tiny glass tube filled with a protective gas. The contacts are actuated by a magnetic field.

BALANCE CONTROL

is provided to compensate moderate level differences between left and right channel. These may root in the recorded material itself, noticeable differences between left and right headphone system, or differences in the user's individual hearing.

All of the above can be carefully compensated.

The balance control offers a precise centre detent in case no adjustment is necessary. In order not to impair the perfect crosstalk specs of HPA V550, it takes effect on the right channel only.

Too loud? Too soft? The PRE-GAIN method

The VIOLECTRIC HPA V550 is specially designed to drive headphones. To do so it is placed between up to three analogue sources and the headphones. Headphones however can present load impedances from 8 to 2000 ohms and efficiency ratios from 85 to 115 dB per Milliwatt. The sources may have output levels between 0.5 Volt up to 10 Volt. Thus, it can be quite tricky to fulfil all demands, since...

... owners of high-efficiency headphones will rarely set the volume control higher than 9 o'clock in order to exclude hearing damage, while

... the maximum setting may still be too soft for low-efficiency headphones, but

... all users expect highest quality at lowest noise and distortion.

Thus, the *circuitry* must adapt itself as the headphones will not do and the sources will seldom do!

WE CALL THE SOLUTION TO THIS PROBLEM PRE-GAIN

A single amp of HPA V550 has no gain (gain = 0 dB = factor 1). In case a balanced headphone is connected two amps are active with a combined gain of +6 dB (factor 2).

By this measure the amps will produce an extremely low self-generated noise which can hardly be heard even with highest sensitive in-ear-monitors (IEM).

On the other hand, the amps of HPA V550 with very powerful transformers and with their high operating voltage are able to drive low efficiency or high impedance headphone to the full with ease. You will be unable to find a headphone driving HPA V550 to its limits. This effortless action will save your precious headphones as they will never see a distorted signal from the amp.

The alignment between amplifier and headphone is provided by the preamp stage, which can boost or attenuate the input signal in seven steps of -18 / -12 / -6 / 0 / +6 / +12 / +18 dB. For this purpose, two switching devices are located on the rear panel for left and right channel individually.

HOW TO OPTIMIZE THE PRE-GAIN SETTING

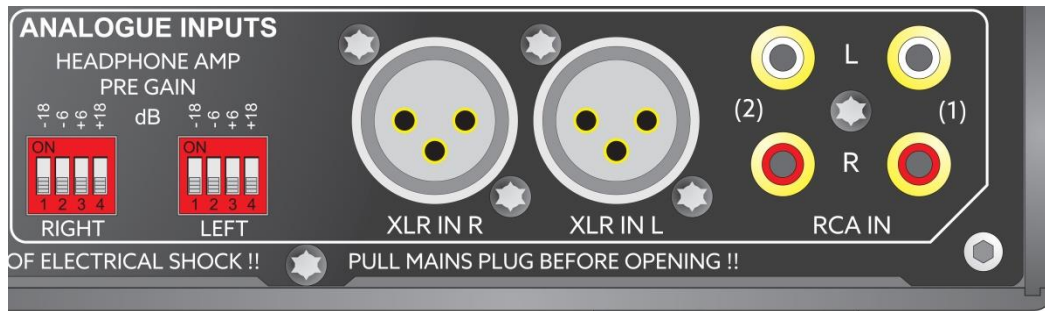

Connect your source to VIOLECTRIC HPA V550 and plug in your headphones. Listen !!
Your amp is adjusted best by the individual PRE-GAIN setting when the volume control for "normal" listening is positioned around 12 o'clock.

So it is provided that there is enough attenuator travel to boost the signal through lower level passages or to listen with higher volume. On the other hand, the attenuator travel is optimized to reduce the self-generated noise from the amp.

THE PRE-GAIN SETTING

Ex works all switches are in "OFF" position, meaning 0 dB gain

	EX WORKS SETTING	
	EINSTELLUNG AB WERK	

In case you cannot reach the 12 o'clock position because the input signal is too loud, feel free to reduce the signal with the PRE-GAIN steps -6 / -12 / -18 dB.

In case the signal is too soft even with volume settings above 12 o'clock please use the PRE-GAIN settings +6 / +12 / +18 dB to achieve more gain.

Other than the above settings are not useful but harmless.

CAUTION

To avoid unwanted level leaps the settings should be altered under the following conditions only:

- the "VOLUME" control should be set to minimum
or the headphone outputs shall be deactivated using the "HEAD" button
- left and right channel settings should be the same
unless you want to settle the amp for different hearing abilities

Ex-factory, all switches are set to their lowest position - i.e. 0 dB PRE-GAIN - which should be sufficient for most applications.

THE AMPLIFIER(S)

The input signals are fed to an amplifier stage especially designed for this application, with 2 x eight transistors per channel. Because of the true balanced operation VIOLECTRIC HPA V550 houses no less than four of those! All in all, 32 of over 50 transistors of the unit are responsible to process analogue signals. The channels are physically separated from each other to ensure optimum crosstalk rejection.

The frequency range covers 5 Hz ... 250 kHz (-0.5 dB) in order to ensure fully linear performance within the entire audible range. Overall gain is set to 0 dB (unbalanced) or +6 dB respectively (balanced) to ensure lowest self-generated noise.

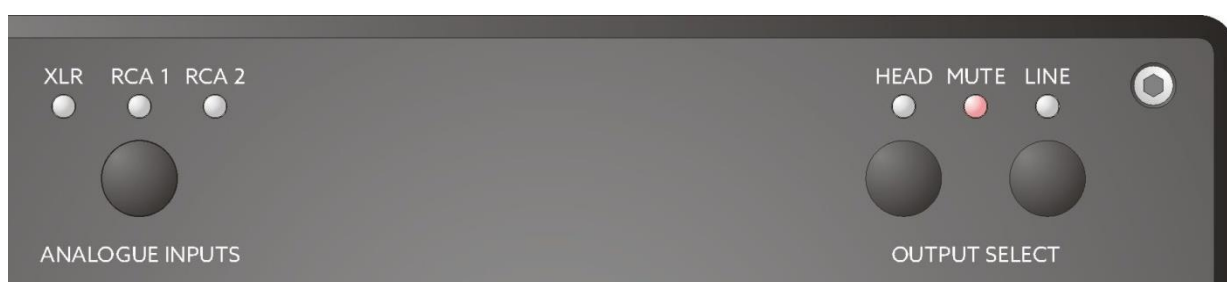

ACTIVATING / DEACTIVATING THE HEADPHONE OUTPUTS

Pressing the "HEAD" button will activate or deactivate the headphone outputs.

The white LED shows the activated state.

This procedure is also maintained by the dedicated button of the remote control.

ACTIVATING / DEACTIVATING THE LINE OUTPUTS

Pressing the "LINE" button will activate or deactivate the line outputs on the back panel.

The white LED shows the activated state.

This procedure is also maintained by the dedicated button of the remote control.

HINT:

When the "MUTE" Button of the remote control is pressed, all outputs from HPA V550 are muted, this concerns the back mounted line outputs and the front mounted headphone outputs.

The front "MUTE" LED is red now.

The mute may be deactivated separately for the headphones outputs or the line outputs by pressing the dedicated button on the front panel or on the remote control.

For both ways simultaneously the mute may be released by pressing the "MUTE" button on the remote control again.

THE BALANCED HEADPHONE OUTPUT

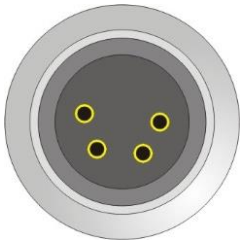

VIOELECTRIC HPA V550 offers a dedicated headphone output to connect balanced headphones. The output is situated on the front panel and comes as a gold plated 4-pin XLR socket.

Balanced Headphone Socket Pin-Out:	
Pin 1	(+) Left channel
Pin 2	(-) Left channel
Pin 3	(+) Right channel
Pin 4	(-) Right channel

THE UNBALANCED HEADPHONE OUTPUTS

The HPA V550 offers two stereophonic headphone outputs, each equipped with a 6.3 mm (1/4") TRS jack socket. Because HPA V550 has a 4-channel amplifier (2 x stereo), each socket is driven by a dedicated stereo amplifier

Please note:

The RIGHT phone jack is connected to the in-phase stereo signal, whereas the left phone jack is connected to the 180° phase shifted signal.

HINT:

To protect the headphones from interferences during powering on/off the outputs are cut during powering on. This procedure takes about five seconds. When powering off the outputs are cut instantly.

Unbalanced Headphone Sockets Pin-Out:	
TIP	Left channel
RING	Right channel
SLEEVE	GND

THE LINE OUTPUTS

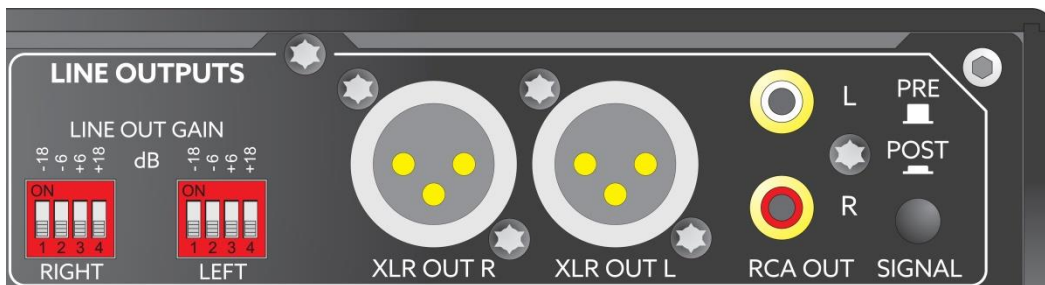

THE UNBALANCED LINE OUTPUTS

are located on the rear panel of the unit and are marked as "RCA OUT L/R". Gold-plated RCA connectors are implemented here.

THE BALANCED LINE OUTPUTS

are located on the rear panel of the unit and are marked as "XLR OUT L" and "XLR OUT R". Gold-plated XLR connectors are implemented here.

Hint:

With a balanced-to-unbalanced adapter this connection may also be used for unbalanced cables. PLEASE NOTE THAT IN THIS CASE PIN 3 HAS TO BE LEFT OPEN!

Balanced Interconnection of the XLR Socket:		Unbalanced Interconnection of the XLR Socket:	
PIN 1	GND	PIN 1	GND
PIN 2	in PHASE	PIN 2	Signal
PIN 3	out of PHASE	PIN 3	OPEN !!

SIGNAL SWITCH: PRE / POST FADER or FIXED-VARIABLE

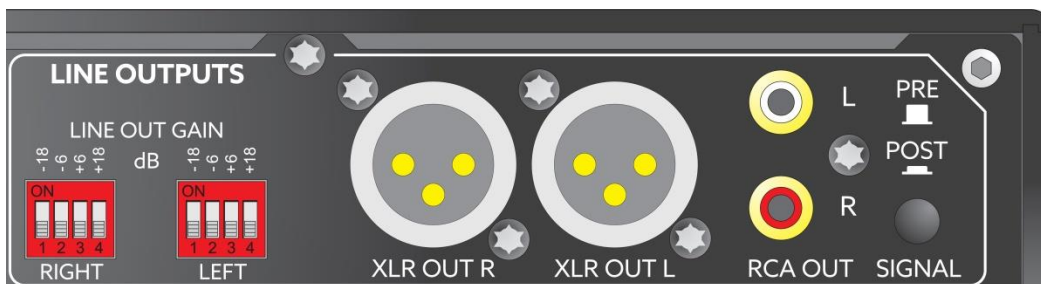

The "SIGNAL" switch is located on the back panel in the "LINE OUTPUTS" field.

The line out signal may be sourced from two different positions inside VIOLECTRIC HPA V550.

If you want to use the activated input signal as is, maybe to source a unit with its own attenuator or a recording device, then the "PRE-FADER" or "FIXED OUT" mode is the right choice. Here, the input signal is routed directly to the line outputs without any alteration from the volume attenuator.

If you like to operate you VIOLECTRIC HPA V550 as pre-amp device of outstanding quality to drive some active speakers or power amps, then "POST-FADER" or "VARIABLE OUT" is the weapon of choice. Now, the line out signal is attenuated by the volume control of VIOLCTRIC HPA V550.

LINE OUT GAIN ADJUSTEMENT (LEVEL ON THE LINE OUTPUTS)

The level of the activated input is buffered and routed unaltered in its level to the line outputs. To adapt the level perfectly to the subsequent device(s) the "LINE OUT GAIN" switches are useful. The operation is similar to the setting of the headphone amp pre gain described on page 16. You may set gain or attenuation in a range of -18 / -12 / -6 / 0 / +6 / +12 / +18 dB.

Hint:

The unbalanced Signal has always -6 dB less level than the balanced signal!

SIGNAL PROCESSING

Inside your VIOLECTRIC HPA V550 the signal is always unbalanced. This is no disadvantage as the so called "fully balanced" signal processing often generates more issues that solving them. It is not possible to preserve a reasonable symmetrical integrity of a signal inside a complex apparatus like HPA V550.

Further, only the unbalanced signal processing is capable to use the device also as a converter between unbalanced and balanced signals.

With your HPA V550 you will be able to feed an unbalanced signal and to listen with your balanced or single ended headphones. Further, you can feed subsequent devices from the unbalanced and/or balanced line outputs.

You may also feed a balanced signal and listen to it with your balanced or single ended headphones. Simultaneously you may again use the unbalanced and/or balanced line outputs.

ERROR REPORTING:

To ensure error-free operation and not to harm your valuable headphones in a comprehensive way your VIOLECTRIC HPA V550 is equipped with a number of protective circuits:

- During powering on there is a five seconds delay to protect your headphones from possibly unwholesome noises. After the time the headphone outputs are switched to the amp. Also, the instant cut-off after powering off is intended to protect your headphones.
- DC voltages are no good part of the output signal and must be avoided. If such are detected, the headphone sockets are cut from the electronics and the "PROTECT" LED is switched to red. When the DC voltage has vanished, the amp will automatically return to "normal" operation.
- Overload causes distorted output signals and is also harmful for the headphones. If an overload was detected, the headphone sockets are cut from the electronics and the "PROTECT" LED is switched to red. When the overload disappeared, the amp will automatically return to "normal" operation.
- All errors will also reset when the unit is switched off and on again. In case that there is still an error condition the protecting circuits will keep the error mode and the status LED is red.

RESET OF THE PROCESSORS

Many internal procedures are enabled by processors.

If - of any reasons - nothing seems to work as it should anymore, follow these instructions to come back to **DEFAULT SETTINGS:**

Push and hold the "ANALOGUE INPUTS" button whilst powering the unit.

Soon after all LEDs on the front panel will light up.

Now you can release the "ANALOGUE INPUTS" button as all settings had been reset to default.

SOFTWARE

Altering the remote control



HPA V550 is delivered with the "Headphone Amp" remote.

It gives direct access to all front panel controls except the balance control and the power switch.

Alternative Mode:

Other remote control codes may be activated for a combined operation with additional Vioelectric gear.

Pushing long (approx. 2 seconds) the "ANALOGUE INPUTS" button the "Remote Control Menu" is entered, the "XLR" LED flashes.

The current state is displayed by the LEDs "RCA 1" and "RCA 2".

Pushing the "HEAD" or "LINE" buttons will alter this state. To finish the procedure, push the "ANALOGUE INPUTS" button again for 2 seconds, the "XLR" LED stops flashing.

XLR flashes	RCA 1 off	RCA 2 off	Remote control not active
	RCA 1 on	RCA 2 off	Remote control "HPA" active (ex works setting)
	RCA 1 off	RCA 2 on	Remote control "DAC" active (not supplied)
	RCA 1 on	RCA 2 on	Remote control "DAC" active in alternative Mode

Things to know ...

Why makes it sense to make such huge efforts?

A headphone amplifier is a device designed to condition audio signals with regard to the very specific requirements of headphones. This does not sound too spectacular at the first glance and can be achieved relatively easy. As with many things however, the devil is in the details and much more effort is required to design **one** amplifier for **all** current headphone models.

Headphones per se are quite diverse, and there are two essential parameters: Impedance and Sensitivity.

In general, headphones with higher impedance can be regarded as less sensitive than headphones with low impedance (which is not generally true, but in the majority of cases). The sensitivity of headphones is usually stated in dB SPL (sound pressure level) per Milliwatt.

Extremes in this sense are the AKG K1000 with 74dB/mW on the one hand, and the Sennheiser HD25 with 108 dB/mW on the other hand: The K1000 requires 2500 times the power to achieve the same sound pressure as the HD25.

There is also the fact that headphones with high impedance usually require much higher voltage to achieve high loudness. Thus, the amplifier *must* be designed with high internal supply voltages.

Which advantages do balanced signals offer?

In contrast to unbalanced signals, balanced signals are carried by two wires (plus ground/shield). In the transmitting device, a balanced signal is created by generating an inverted signal (180° phase shifted). The "hot" wire carries the original signal (a), the "cold" wire carries the inverted signal (-a).

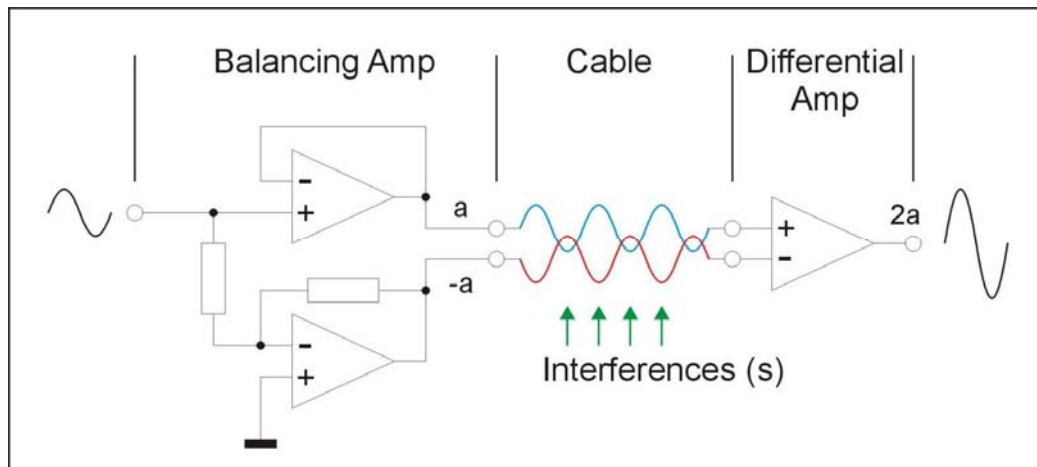

In the receiving device, the balanced signal is processed by a differential amplifier which detects the difference between both: $(a) - (-a) = 2a$.

On its way between devices, the useful signal can be affected by interference (s). Interferences however are in phase on both wires and fed to the differential amplifier as well. Again, the amplifier detects the difference between the interference contents: $(s) - (s) = 0$.

Thus - in an ideal situation - all interference on the signal path is eliminated.

Why are op-amps ideal for low-level signal processing?

Discrete amplifiers (designed with transistors) are very popular in high-end audio design also for preamplifier stages. This is often marketed as an optimization measure, but the partially exorbitant extra expenses are of course to be paid by the customer.

But an op-amp consists of transistors as well ... moreover, its structure has the advantage of thermal coupling between its internal components. Also ageing issues play a much less important role. Due to the large number of op-amps types offered, it is possible to pick an optimum type for any specific application.

Why does PRE-GAIN make sense?

Two extreme examples (with the HPA V550 with +6 dB gain (factor 2), volume control set to full):

1st example:

The (pre-) amplifier provides 8 V output voltage, whereas the headphone requires only 2 V for 100 dB sound pressure level.

With the volume control fully turned up, the amp would deliver 16 V output at +6 dB gain. Therefore, the volume control would have to be operated very carefully to avoid hearing damage. Moreover, any interference at the input should be avoided since it would be "unforgivingly" amplified as well.

With PRE-GAIN, the input level can be reduced by 12 dB (a fourth), with 2 V instead of 8 V input level as the result. This 2 V is again amplified by 6 dB, then equalling around 4 V. Now the volume control can be turned over almost the entire range.

2nd example:

The (pre-) amplifier provides 2 V, whereas the headphone requires 10 V to release 100 dB of sound pressure.

With the volume control fully clockwise, the amp would provide around 4 V at +6 dB gain only - much too low for the headphone. By means of PRE-GAIN, input level can be boosted by 12 dB (four-fold), resulting in effective 8 V input voltage instead of 2 V. These are again multiplied by 6 dB or factor 2, now equalling 16 V. This is more than enough to drive the headphone.

Why does frequency bandwidth limiting make sense?

In signal processing, sound is represented by AC voltages. Sound is audible - for young people - from about 20 to 20000 Hz. The elder the listener, the less he will hear high frequencies in particular. In order to transmit these frequencies at optimum quality, the frequency response of an amplifier should be as wide and as "flat" as possible. At the low end of the scale, this limit is represented by DC, as there is no frequency lower than zero. In upward direction, the limit can be set to practically any frequency, but the higher, the more susceptible the device becomes concerning electro-magnetic interference. This is not audible in the first place - but may interfere with the useful signal and then become evident. Therefore, unrestricted frequency response attests thoughtlessness rather than remarkable engineering skill.

Why a good volume attenuator is essential?

"Normal" devices do have a volume potentiometer which is a mechanical control element, it can be obtained on the market at any low price. Meanwhile it is often replaced by electronic circuitry, often exhibiting essential disadvantages concerning dynamic range, noise and distortion. Conductive-plastic resistive tracks, high-quality multi-tap wipers and separated chambers for the individual sections are highly desirable for sophisticated applications, and high quality is inevitable to ensure trouble-free operation for years. Since the market for really good pots is a small one, manufacturers like Noble or Panasonic don't offer these anymore. A current sample of top of the line pots is the RK27 by ALPS, which is used inside HPA V550 (standard version).

About the sophisticated volume control of HPA V550 PRO

It offers a just normal looking big knob on the front panel. To enable the same touch and feel of standard solutions we are using a motor driven potentiometer. Due to a friction clutch between motor and potentiometer, manual and remote operation of the knob at the same time is possible without the risk of damage (although not useful...).

The potentiometer has nothing to do with the analogue signals from HPA V550 PRO but generates a control voltage which is transferred into the digital domain by an analogue-to-digital converter and fed to a micro controller which generates the digital word to control a 256 step relay attenuator. The relays are very special "Reed Relays". Here, the switching contacts are situated in a glass tube filled with a protective gas. The contacts are actuated by a magnetic field.

The 256 steps are realized with 8 relays per channel because $2^8 = 256$.

Each step is defined as 0.4 dB which totals in over 100 dB attenuation range. The contacts of the relays are switching between resistors with an accuracy of 1% or 0.1% to attenuate the signal. So best channel matching and minimal crosstalk is realized - and the relays will never scratch.

Why a low output impedance is essential?

When actuated, electro-dynamic systems respond with a counterforce. When the voice coil of a headphone has been displaced by the signal, an (error-) current will be induced when it swings back to its initial position. This current must be suppressed as far as possible, which is affected best if the amplifier's output impedance is the lowest possible. The damping factor describes nothing but the ratio between the output impedance of an amplifier and a given load.

Since there is no known technical specification, we define the load (voice coil impedance) as 50 Ohms. With HPA V550 having an output impedance of < 0.3 ohms in balanced mode and < 0.15 Ohms in unbalanced mode this results in a damping factor of 160 (balanced) and a damping factor of 320 (unbalanced).

Due to general recommendations the output impedance of an amp shall not be higher than 5 % of the headphone impedance, that means a minimum damping factor of 20.

Why are high supply voltages essential?

A headphone doesn't really require high power, but from the equation $P = U^2 / R$ we can see that the square of the supply voltage determines the power into a given load resistance. The higher the headphone's impedance, the more voltage will be needed to achieve high listening levels. But this deals with the achievable loudness to a limited extent only: Technically spoken, music lives on fast transients which put high demands on signal processing. And thus, a fast transient can easily push an average amplifier with +/-15 volts supply to its limits (95 % of all headphone amps in the market are operated with these or even lower supply voltages). Due to the high supply voltage and the balanced operation mode of HPA V550 you will benefit from far over two times more output voltage swing capability compared to single ended amps with "standard" supply voltage.

Why we are making our amps in such a way.

They are made with transistors and operated with +/- 25 V supply voltage because it is sensible to do so. But a headphone amp must not be as powerful as a speaker amp.

Our "power" stage consists of eight transistors, four small ones, four bigger ones, all of them very fast. They are driven by an op-amp in non-inverting mode, the gain is set to 0 dB. In balanced mode the gain equals +6 dB as two power stages act in push-pull mode.

For high impedance headphones a very high output voltage of 21 V RMS is achieved - while low impedance headphones will profit from a power over 6 Watt into 50 Ohms per channel.

Under all operating conditions noise, distortion and dynamic range is on the edges of physics.

Why does a output relay make sense when switching power?

Amplifiers generate unwanted output signals when applying or removing power, which can damage the connected headphones. The relay breaks the connection between amplifier and headphone for some seconds after power-on and thus protects the latter until electrical conditions have stabilized.

DISPOSAL

Disposal of Old Electrical & Electronic Equipment - WEEE Regulation

(Applicable in the European Union and other European countries with separate collection systems)



This symbol on the product or on its packaging indicates that this product shall not be treated as household waste. Instead it shall be handed over to the applicable collection point for the recycling of electrical and electronic equipment.

By ensuring this product is disposed of correctly, you will help prevent potential negative consequences for the environment and human health, which could otherwise be caused by inappropriate waste handling of this product.

The recycling of materials will help to conserve natural resources.

For more detailed information about recycling of this product, please contact your local Civic Office, your household waste disposal service or the shop where you purchased the product.

TECHNICAL DATA VIOLECTRIC HPA V550

All measurements RMS unwt'd., 20 Hz - 20 kHz, Pre-Gain set to 0 dB

Input Parameter Analogue

Inputs (stereo, analogue): 1 x XLR female, balanced,
2 x RCA, unbalanced

Max. Input Level: + 21 dBu

Input Impedance: 10 kOhm

Line Out Parameter

Line Outputs (stereo, analogue): 1 x XLR male, balanced
1 x RCA unbalanced

Line-Out Gain: -18 / -12 / -6 / 0 / +6 / +12 / +18 dB

Max. Output Voltage: + 21 dBu

Output Impedance: < 1 Ohm

Headphone Amplifier Parameter

Nominal Input Sensitivity: +6 dBu

Amp Gain: 0 dB unbal / +6 dB bal

PRE-GAIN: -18 / -12 / -6 / 0 / +6 / +12 / +18 dB

Frequency Range: 5 Hz ... 250 kHz (- 0,5 dB)

Balance: +/- 6 dB, only effective in the right channel

Output Impedance: 0,15 Ohm unbal / 0,3 Ohm bal

Damping Factor (Load 50 Ohm): 320 unbal / 160 bal

Dynamic Range: > 131 dB (A-wtd)

Noise: < -103 dBu (A-wtd)

THD+N (1kHz/2x10V/100R = 1W): < -102 dB / < 0,0008 %

THD+N (1kHz/2x4V/32R = 0,5W): < -100 dB / < 0.001 %

Crosstalk: -105 dB (1 kHz) / -100 dB (15 kHz)

Headphone Outputs: 1 x 4-pol XLR
2 x 1/4" (6.3 mm) TRS jack

Max. Output Level

R_L	U_a (dBu)	U_a (V)	P_a (mW)
600	28,7	21,1	740
300	28,6	20,9	1450
100	28,5	20,7	4300
50	27,3	17,9	6400
32	24,0	12,3	4700
16	17,3	5,7	2000
8	12,3	3,2	1300
4	6,8	1,7	700

Conditions:

Balanced Operation

Both Channels Loaded

(1kHz / < 0.1% THD+N)

Supply Voltage:

230 V AC / 115 V AC max. 50 VA

Front, Back:

8 mm / 3 mm Aluminum, black anodized

Case:

3 mm / 4 mm Aluminum, black anodized

Case Dimensions:

290 x 80 x 254 mm (B x H x T) / 11,4" x 3,15" x 10" (W x H x D)

Overall Dimensions:

290 x 90 x 282 mm (B x H x T) / 11,4" x 3,5" x 11,1" (W x H x D)

Dismantling / Jumper Settings

Please note:

In the following, the internal settings of the HPA V550 are discussed.

For changing these, a TORX T10 screwdriver or Philips #1 is required and you should by all means

PULL THE MAINS PLUG !!!

Only thereafter the settings can be altered without any hazard.

Dismantling



1. Screw off eight screws from the top of the case







2. The upper lid is situated in a rabbet of the front panel
Lift the lid on the back end and slide it out.
3. Make your settings
4. Assemble the unit in opposite order

SETTINGS ON VIOELECTRIC HPA V550

(leave all other settings as they are - except you know exactly what you are doing !!)

XLR GROUND-LIFT JUMPERs (see page 6/7)		
 GROUND POSITION (ex works)	 LIFT POSITION	 CHASSIS POSITION

GENERAL CASE) GROUND-LIFT JUMPER (see page 6/7)	
 LIFT POSITION (ex works)	 GROUND POSITION

AC Voltage setting (see page 11)	
 The unit is set to 230 V	 The unit is set to 115 V

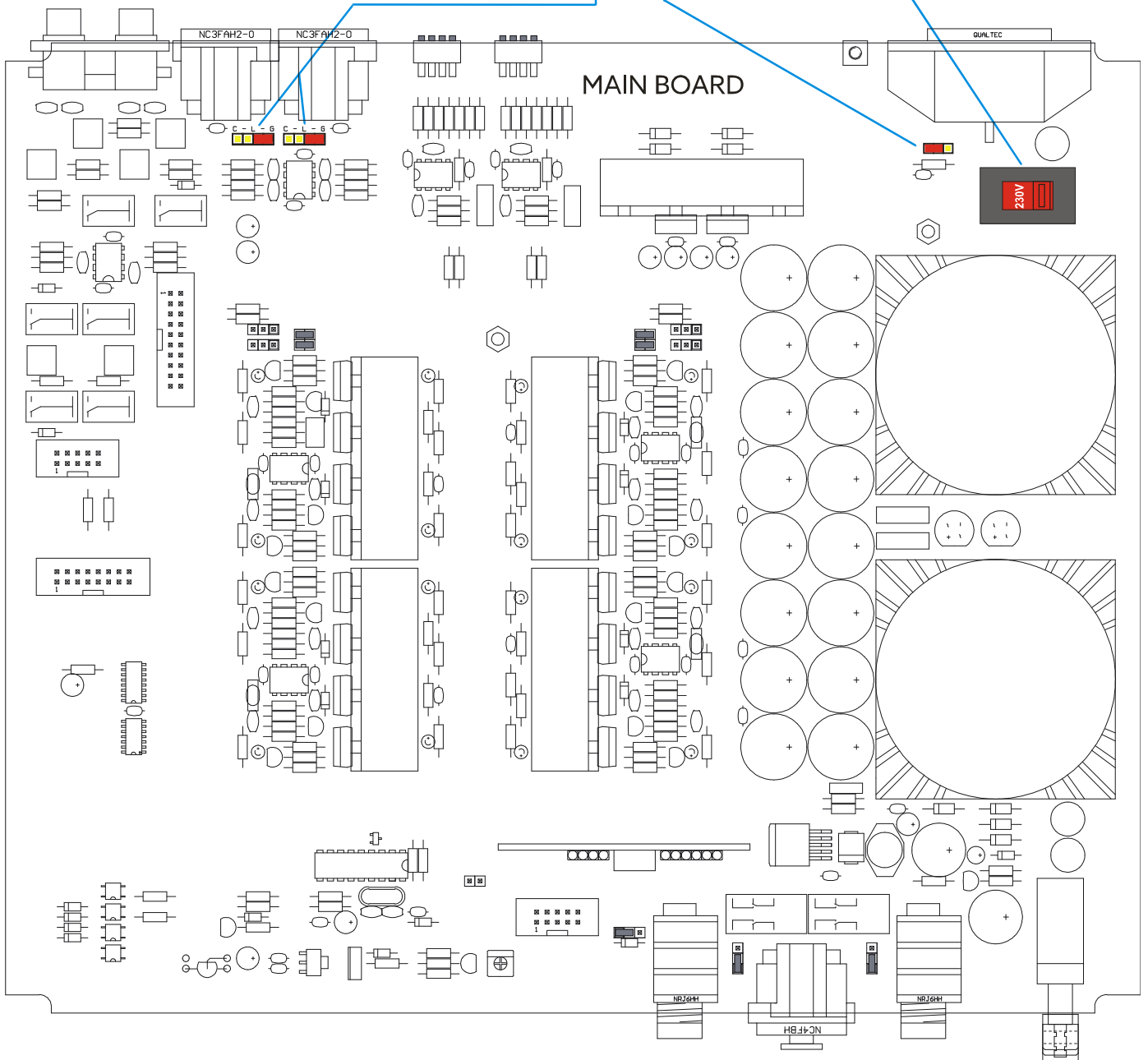
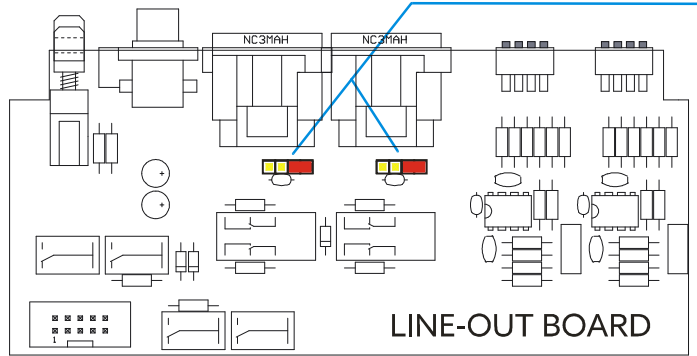

EC CONFORMITY STATEMENT:

We herewith declare that the following unit

Name: **VIOELECTRIC HPA V550 / HPA V550 PRO**

Serial No.: -all -

is in conformity with the following EC directives:

GENERAL GROUND-LIFT JUMPER (see page 6/7)

2014/35/EU	Low voltage directive
2004/30/EU	EMC directive
EN 60065:2014/AC:2016	Security directives for audio-,
JIS C6065:2016	video- und similar electronic devices
2001/95/EC	General Product Safety Directive

For verification of conformity with regards to electromagnetic compatibility the following harmonized standards are applied:

IEC 61000-6-1:2019	Generic emission standard (residential)
IEC 61000-6-2:2019	Generic emission standard (industrial)
IEC 61000-6-3:2007+A1:2011	Generic immunity standard (residential)
IEC 61000-6-4:2007+A1:2011	Generic immunity standard (industrial)

Product family standard for household appliances, multimedia equipment, information technology equipment.

CISPR 14-1:2016	CISPR 32:2015
CISPR 14-2 :2015	CISPR 24:2010

2011/65/EU, RoHS directive

2012/19/EU, WEEE directive / Member No.: DE 26076388

This declaration is given under responsibility of:



LAKE PEOPLE

LAKE PEOPLE electronic GmbH
Turmsse 7a
D-78467 Konstanz
Fon +49 (0) 7531 73678
Fax +49 (0) 7531 74998

Konstanz 03.07.2020 Fried Reim CEO

WARRENTY

Since 1986 we are constructing and manufacturing sophisticated electronics for ambitious customers.

Since the early beginnings we are trying hard by accompanying measures, the use of 1st choice components and multiple quality checks during production to avoid faults at large.

We are quite effective in that and this is - amongst others - why we enjoy such a good reputation.

Despite all accurateness faults may appear which may derogate the proper operation of your product.

In this case your unit is protected by a **5-year Warranty!**

Needless to say that we will care for your product even after the expiration of the warranty.

If it is necessary, please dispatch your item to:

Lake People electronic GmbH
Turmstrasse 7a
78467 Konstanz
Germany

Fon +49 (0) 7531 73678
Fax +49 (0) 7531 74998
E-Mail info@lake-people.de
Web www.lake-people.de

Your warranty claim begins with the date of purchase, which should be denoted on your proof of purchase.

Do not forget to include the receipt of sales or a copy of the receipt.

Please also include a short description of the fault(s).

For the reshipment we need you correct address!

Care for a safe packaging.

Best is to use the original packaging.

Please keep in mind that we cannot accept collect freight.

We will grant a quick repair and quick return of the unit.

In case of a warranty repair we will reship free of charge.

Please denote here the serial number and the date of purchase:

Serial Number

Date of Purchase

