

Multifuser DC2

Installation Manual

EN

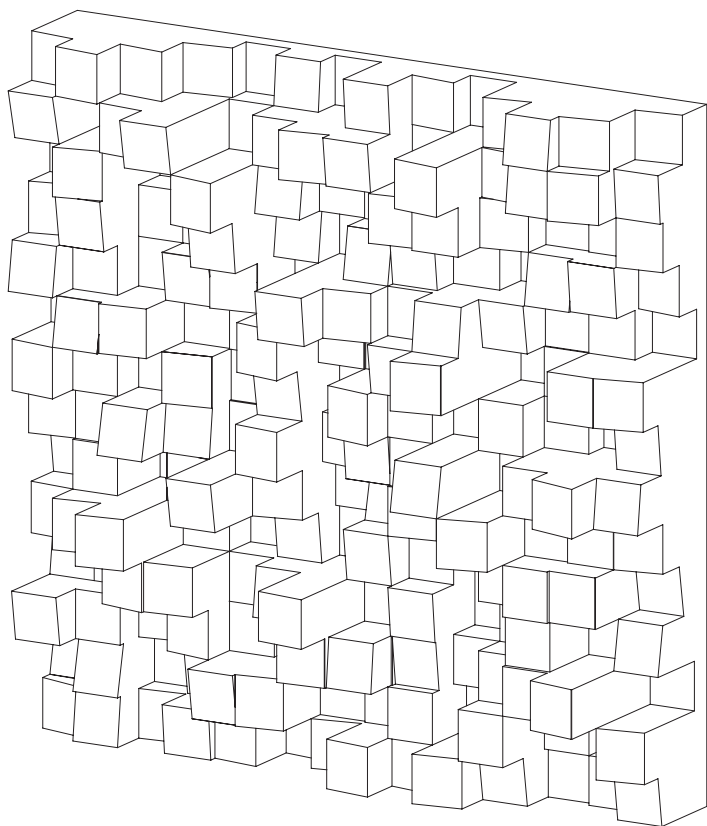

✓ MATERIAL NEEDED

Included

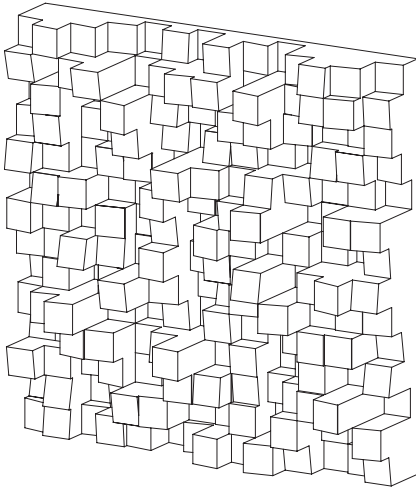

Multifuser DC2 x6

Not Included

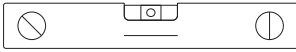

Level

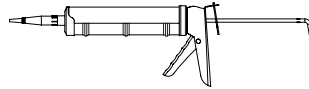

Glue



Measuring Tape

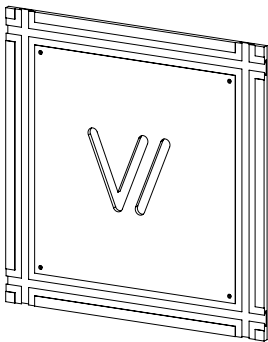

Vic Fix Base

You may also install this product with the new VicFix J Profile fixation system using VicFix Base, sold separately.

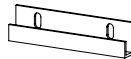

VicFix J Profile 80mm | 3.14"

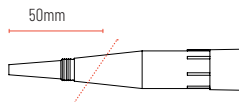

Cut the tip of the glue nozzle according to the diagram.

1

Apply the glue on the back of the acoustic panel, near the edges. Do not wait longer than 10 minutes after applying the glue to attach the panel to the wall.

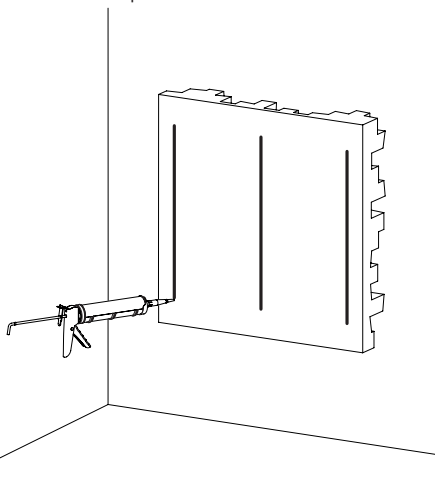

2

Place the panel on the suitably chose position on the wall. Once in the desired place, press firmly against the wall for 15 seconds.

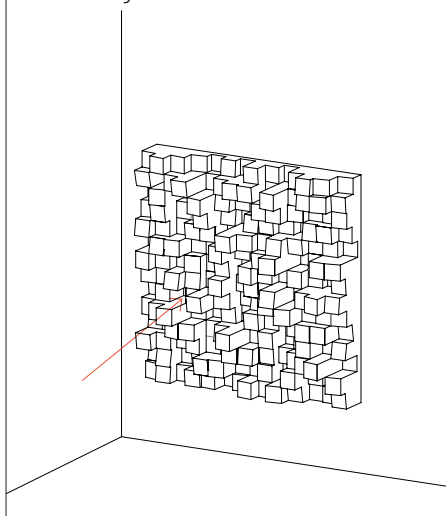

!

To ensure that you maximise the strength of the glue, don't make any adjustments to the panel after bonding

Wall and ceiling surfaces should be examined prior to installation, ensuring they are clean, smooth, and dry. If you have unpainted gypsum board surfaces, these should be primed with a drywall primer (or another material manufactured especially for the purpose), to equalize the absorption between the gypsum board face paper, joint compound, and skin coating materials. You should then apply the paint, and allow air circulation in order to dry the paint within the time frame specified by the paint manufacturer. Please ensure the paint is dry before installing the acoustic panel. Make sure the room has all the necessary conditions to receive the acoustic panels. After you apply the glue on the back of each acoustic panel, please ensure you hold the acoustic panel against the wall the required time (mentioned above), and ensure it stays fixed in place. This method is also applicable to ceiling installations.

Main Office, R&D & Logistics

Avenida do Pólo 3, N.º 159, Carvalhosa
4590-137 Paços de Ferreira, Portugal

Office

Rua Quinta do Bom Retiro N.º 16, Armazém 9
2820-690 Charneca da Caparica, Portugal
T (+351) 212 964 100

Info and Sales

E sales@vicoustic.com

www.vicoustic.com



© Vicoustic, 2021 | V2

No parts of this document might be copied and/or published without written consent of Vicoustic.