

# Wireless Stereo Headphone System

## Operating Instructions

### Checking the included items

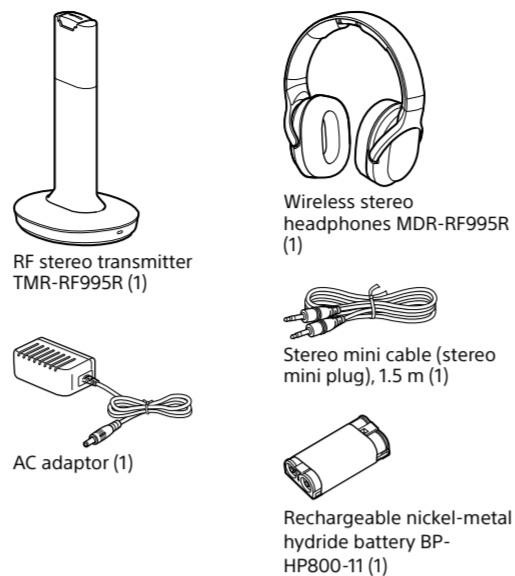

### Features

- Thank you for purchasing the Sony MDR-RF995RK Wireless Stereo Headphone System. Before operating the unit, please read this manual thoroughly and retain it for future reference.
- Some features are:
- Wireless system that allows you to listen to a program free the restriction of a cable
  - Up to 45 meters (150 feet) reception range\*
  - High fidelity sound reproduction
  - New mode "VOICE" for clear hearing of personal voice range
  - Noise reduction system to reproduce a clear sound with minimum transmission noise
  - Comfortable fit
  - Smooth and Comfortable Earpads
  - Long playback time (maximum 20 hours)
  - Easy recharging function with secure charging mechanism
  - Rechargeable Battery
  - Automatic tuning on headphones for optimum signal reception
  - 3 transmission channels available
  - Volume control function and sound effect function on the headphones
- \* Transmission distance varies depending on conditions of use



©2017 Sony Corporation Printed in Vietnam

MDR-RF995RK

### How to use

#### 1 Insert the supplied rechargeable battery BP-HP800-11 into the left housing of the headphones.

Observe the correct polarity when installing battery.

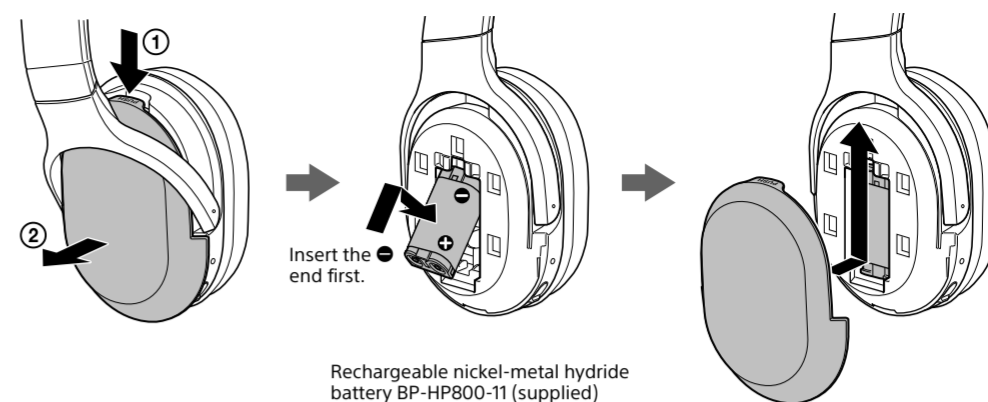

Rechargeable nickel-metal hydride battery BP-HP800-11 (supplied)

#### 2 Connect the AC adaptor.

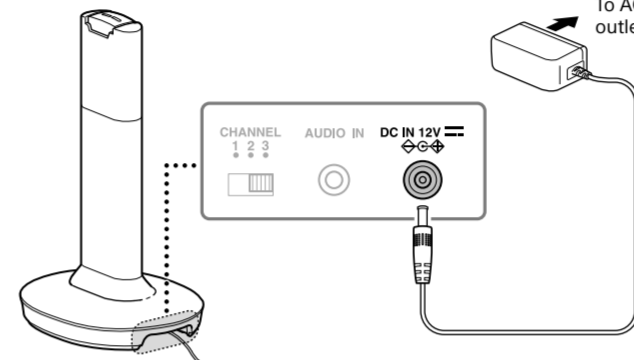

#### 3 Charge the headphones.

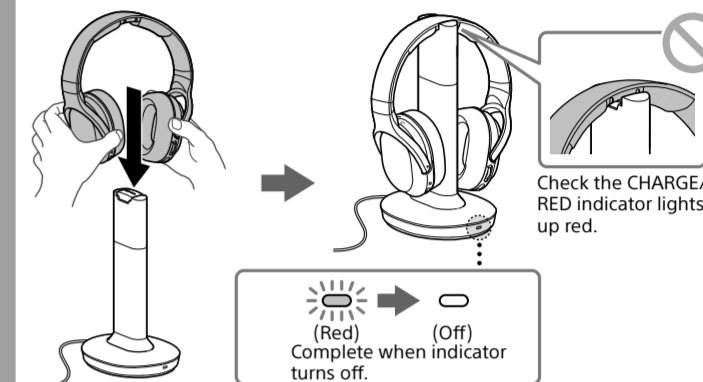

#### 4 Connect the A/V component, following hookup A or B below.

##### A Using the headphone jack of the A/V component

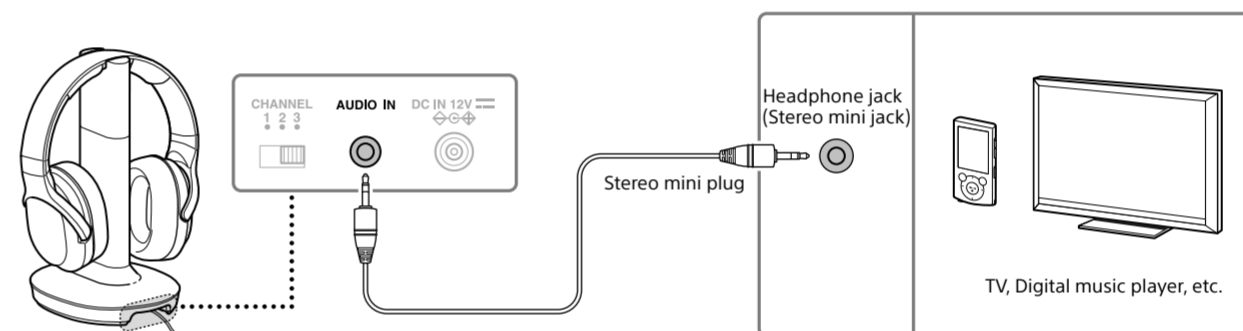

##### B Using the audio out (L/R) jacks of the A/V component

Use a connection cable (not supplied) between the transmitter and the A/V component.

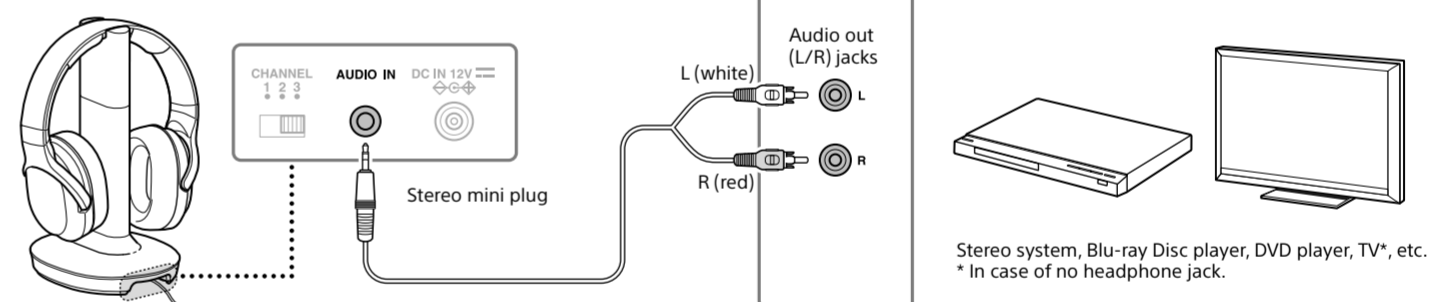

If the sound is distorted by connecting the transmitter to the A/V component's audio out (L/R) jacks, reconnect the transmitter to the headphone jack. If the transmitter detects no signal or no sound, check the connection of the connected A/V components, then check the audio setting of the connected A/V components.

#### 5 Wear the headphones.

**Before listening**  
To reduce the risk of hearing damage, first lower the volume.

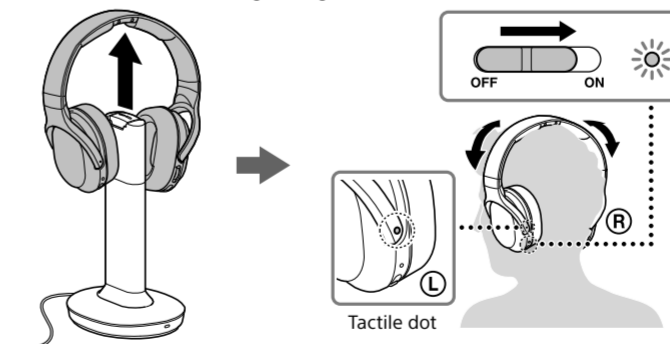

#### 6 Start playback of the A/V component.

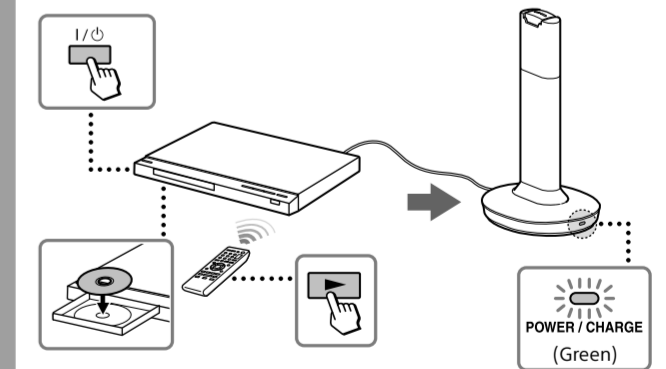

#### 7 Adjust the volume.

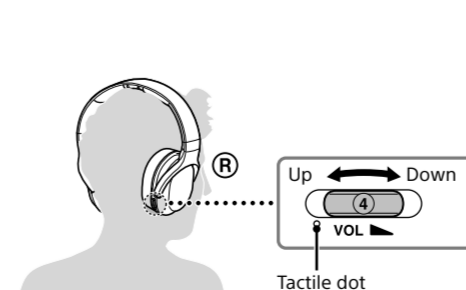

#### After use

Turn off the power of the headphones.

##### About sending RF signals

The transmitter starts sending RF signals automatically when it detects an audio signal from the connected component. Note that;

- Noise may occur depending on the transmitter position and room conditions. It is recommended to place the transmitter in a location that produces the clearest sound.
- If the transmitter is placed on a metallic table, you may hear noise, or the reception range may decrease. Do not place on a metallic table.

##### If no signal or low signal is input for about 4 minutes

When no signal is input for about 4 minutes, the transmitter turns off automatically\*. The POWER indicator of the transmitter blinks for 4 minutes, then turns off. The transmitter restarts after receiving an audio signal again. The transmitter may also turn off if low signal is input for about 4 minutes. In this case, raise the volume of the connected A/V component within the range where the sound is not distorted, then lower the volume of the headphones. \* If signal noise is output from the connected A/V component, the transmitter may not turn off, even when no audio signal is input.

### WARNING

To reduce the risk of fire or electric shock, do not expose this apparatus to rain or moisture.

To reduce the risk of fire or electric shock, do not expose this apparatus to dripping or splashing, and do not place objects filled with liquids, such as vases, on the apparatus.

Do not expose the batteries (battery pack or batteries installed) to excessive heat such as sunshine, fire or the like for a long time.

To avoid electrical shock, do not open the cabinet. Refer servicing to qualified personnel only.

Do not install the appliance in a confined space, such as a bookcase or built-in cabinet.

The AC Adaptor is not disconnected from the mains as long as it is connected to the AC outlet, even if the unit itself has been turned off.

As the main plug of AC power adaptor is used to disconnect the AC power adaptor from the mains, connect it to an easily accessible AC outlet. Should you notice an abnormality in it, disconnect it from the AC outlet immediately.

Excessive sound pressure from earphones and headphones can cause hearing loss.

The nameplate of transmitter is located on the bottom exterior.

The nameplate of the headphones is located on the back side of the slider.

### Information

You are cautioned that any changes or modifications not expressly approved in this manual could void your authority to operate this equipment.

If you have any questions about this product, you may call:

Sony Customer Information Services Center  
1-800-222-7669 or <http://www.sony.com/>

#### Declaration of Conformity

Trade Name: SONY  
Model No.: MDR-RF995R  
(Headphones Unit)  
Responsible Party: Sony Electronics Inc.  
Address: 16535 Via Esprillo, San Diego, CA 92127 USA  
Telephone No.: 858-942-2230

This device complies with Part 15 of the FCC Rules. Operation is subject to the following two conditions: (1) this device may not cause harmful interference, and (2) this device must accept any interference received, including interference that may cause undesired operation.

### Note

This equipment has been tested and found to comply with the limits for a Class B digital device, pursuant to Part 15 of the FCC Rules. These limits are designed to provide reasonable protection against harmful interference in a residential installation. This equipment generates, uses and can radiate radio frequency energy and, if not installed and used in accordance with the instructions, may cause harmful interference to radio communications. However, there is no guarantee that interference will not occur in a particular installation. If this equipment does cause harmful interference to radio or television reception, which can be determined by turning the equipment off and on, the user is encouraged to try to correct the interference by one or more of the following measures:

- Reorient or relocate the receiving antenna.
- Increase the separation between the equipment and receiver.
- Connect the equipment into an outlet on a circuit different from that to which the receiver is connected.
- Consult the dealer or an experienced radio/ TV technician for help.

#### For the customers in Canada

This device complies with Industry Canada's licence-exempt RSSs. Operation is subject to the following two conditions:  
(1) This device may not cause interference; and  
(2) This device must accept any interference, including interference that may cause undesired operation of the device.

#### For the customers in the USA and Canada

#### RECYCLING NICKEL METAL HYDRIDE BATTERIES

Nickel Metal Hydride batteries are recyclable. You can help preserve our environment by returning your used rechargeable batteries to the collection and recycling location nearest you.



For more information regarding recycling of rechargeable batteries, call toll free 1-800-822-8837, or visit <http://www.call2recycle.org>

Caution:  
Do not handle damaged or leaking Nickel Metal Hydride batteries.

## How to use the transmitter

### If you cannot receive a clear audio signal

First change the radio frequency with the CHANNEL selector switch on the transmitter, then briefly press the AUTO TUNING button on the headphones.

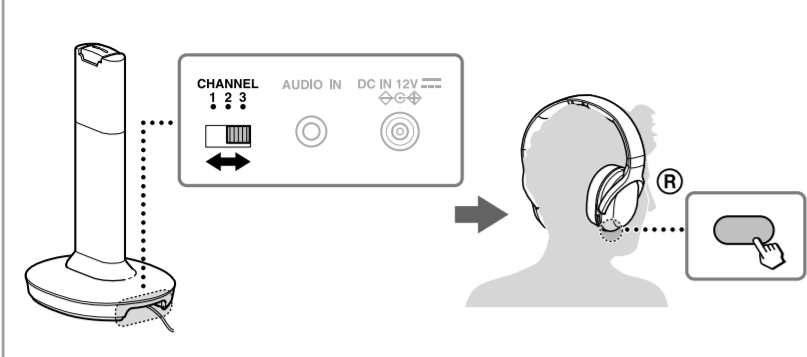

## How to use the headphones

## Tips for charging

### Charge supplied battery first

The supplied rechargeable nickel-metal hydride battery is not charged from the first time you use it. Be sure to charge them before use.

### About auto charge function

Placing the headphones on the transmitter automatically turns them off, then charging starts. This eliminates the need for turning on/off every time you wear and take off the headphones.

### If CHARGE/RED indicator does not light up red

- Check if the right and left headphones are rested on the transmitter correctly. Take off the headphones and place them on the transmitter again so that the headphones’ contact points meet the transmitter’s contact pins.
- Charging may not be completed if the transmitter’s contact pin and headphones’ contact point are dusty. Wipe them with a cotton bud, etc.

### Charging and usage time

Approx. charging time	Maximum usage time <sup>1)</sup>
7 hours <sup>2)</sup>	20 hours <sup>3)</sup>

- 1) at 1 kHz, 0.1 mW + 0.1 mW output
- 2) hours required to fully charge an empty battery
- 3) Time may vary, depending on the temperature or conditions of use.

### To recharge supplied battery after use

Place the headphones on the transmitter after use. The CHARGE/RED indicator lights up red, then charging starts. When charging is complete, there is no need to remove the headphones from the transmitter.

### Remaining battery

To check the remaining battery charge of the headphones, turn on the POWER switch and check the POWER indicator. The battery is still serviceable when the indicator lights up green.

Charge the headphones if the POWER indicator turns off, dims, flashes, or the sound becomes distorted or noisy.

### Notes

- Insert the AC adaptor plug firmly.
- Be sure to use the supplied AC adaptor. Using AC adaptors with different plug polarity or other characteristics can cause product failure.

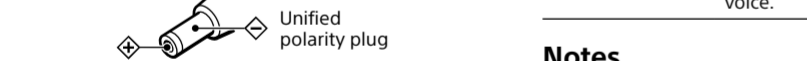

- The battery capacity may decrease if the headphones are turned on and placed on the transmitter with the AC adaptor disconnected.
- The transmitter automatically turns off while charging the headphones.
- This system is designed to charge only the supplied rechargeable battery BP-HP800-11 for safety. Note that other types of rechargeable battery cannot be charged with this system.
- If dry batteries are installed, they cannot be charged.
- Do not attempt to use the supplied rechargeable battery BP-HP800-11 for other components. It is for use with this system only.
- Charge in an environmental temperature of between 5 °C and 35 °C (between 41 °F and 95 °F).
- When the battery life reduces to half, this may be the end of battery lifetime. The supplied rechargeable battery BP-HP800-11 is not commercially available. You can order the battery from the store where you purchased this system, or at your nearest Sony dealer.
- Do not touch the contact pins of the transmitter. If the contact pins become dirty, charging may not be possible.
- Charging may not be completed if the transmitter’s contact pins and headphones’ contact points are dusty. Wipe them with a cotton bud, etc.

# Using the headphones with separately-sold dry batteries

Commercially available (LR03 (size AAA)) dry batteries can also be used to power the headphones. Install two batteries in the same manner as described in step 1 of “How to use.”

If you attempt to charge the headphones with dry batteries installed, the CHARGE/RED indicator lights up red for 15 seconds, then turns off. The battery charge function is not activated.

### How to use the transmitter

## Noise Reduction process

The transmitter compresses the audio signal and converts it to RF signal. The headphones convert the received RF signal to an audio signal and decompresses it. This process reduces noise picked up during transmission.

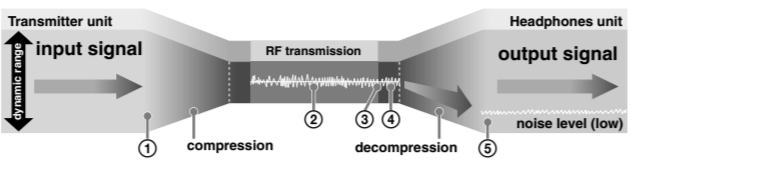

- ① The transmitter compresses the audio signals dynamic range, then converts it to RF signal.
- ② Noise may occur due to long distance transmission, etc.
- ③ The headphones convert the RF signal to an audio signal.
- ④ Noise may occur during conversion.
- ⑤ Decompression of the audio signals dynamic range reduces the noise level and improves the S/N (signal-to-noise) ratio.

Battery	Approx. usage time <sup>1)</sup>
Sony alkaline battery LR03 (size AAA)	24 hours <sup>2)</sup>

- 1) at 1 kHz, 0.1 mW + 0.1 mW output
- 2) Time may vary, depending on the temperature or conditions of use.

### Note

Do not carry a dry battery together with coins or other metallic objects. It can generate heat if the positive and negative terminals of the battery are accidentally come into contact with metallic objects.

## How to use the headphones

### Tips for connection

- When you connect the stereo mini cable (stereo mini jack) directly to an earphone jack (monaural mini jack), the audio signal may not be output through the right channel.

## How to use the headphones

## Tips for volume setting

- If you connect the transmitter to the headphone jack of the A/V component, set the volume of the A/V component as high as possible but not so high that the audio signal becomes distorted.
- When watching videos, be careful not to raise the volume too high in quiet scenes. You may hurt your ears when a loud scene is played.

## How to use the headphones

Slide the switch to select the desired sound effect, OFF or VOICE.

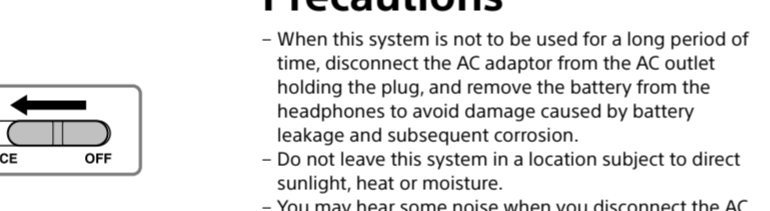

Position of switch	Sound effect and suitable sound source
OFF	Normal playback of the headphones.
VOICE	Produces a clearer announcer’s voice.

### Notes

- The volume of the headphones may vary, depending on the input signal and the setting of the EFFECT switch.
- The sound effect may not be obtained depending on the input sound sources.

## Tips for better reception

### Receiving performance

This system utilizes very high frequency signals in the 900 MHz band so the receiving performance may deteriorate due to the surroundings. The following examples illustrate conditions that may reduce the reception range or cause interference.

- Inside a building with walls containing steel beams
- An area with many steel file cabinets, etc.
- An area with many electrical appliances capable of generating electromagnetic fields
- The transmitter is placed on a metal instrument.
- An area facing a roadway
- Noise or interfering signals exist in the surroundings due to radio transceivers in trucks, etc.
- Noise or interfering signals exist in the surroundings owing to wireless communication systems installed along roadways.

### Effective area of the transmitter

The optimum distance is up to approximately 45 m (150 ft) without the system picking up some interference. However, the distance may vary depending on the surroundings and environment.

- If the system picks up some noise within the above mentioned distance, reduce the distance between the transmitter and the headphones, or select another channel.
- When you use the headphones inside the effective area of the transmitter, the transmitter can be placed in any direction from the listener.

### The sound cuts off

- The transmitter turns off if no signal or low signal is input for 4 minutes. If you connect the transmitter to an A/V component using the headphone jack, raise the volume level on the connected A/V component within the range where the sound is not distorted.

### Distorted or intermittent sound (sometimes with noise)

- Use the headphones near the transmitter, or change the position of the transmitter.
- Do not place the transmitter on a metallic table.
- If you connect the transmitter to an A/V component using the headphone jack, lower the volume level on the connected A/V component within the range where the sound is not distorted.
- Change the radio frequency with the CHANNEL selector on the transmitter, then change the radio frequency to that of the transmitter with the AUTO TUNING button on the headphones.
- Charge the supplied rechargeable battery, or replace dry batteries with new ones. If the POWER indicator is still off after charging, take the headphones to a Sony dealer.

### Loud background noise

- If you connect the transmitter to an A/V component using the headphone jack, raise the volume level on the connected A/V component within the range where the sound is not distorted.
- Charge the supplied rechargeable battery, or replace dry batteries with new ones. If the POWER indicator is still off after charging, take the headphones to a Sony dealer.
- Do not place the transmitter on a metallic table.
- Use the headphones near the transmitter.

### The POWER/GREEN indicator flashes green

- No signal or low signal is input. Start playback of the A/V component, or raise the volume of the connected A/V component within the range where the sound is not distorted, otherwise the transmitter will turn off. If no signal or low signal is input for about 4 minutes, the transmitter turns off automatically.

### Battery cannot be charged/ CHARGE/RED indicator flashes red, or does not light up red

- Check that the right/left of the headphones and transmitter correspond, and put the headphones on the transmitter correctly.
- Install the supplied rechargeable nickel-metal hydride battery. Dry batteries and rechargeable batteries other than the supplied cannot be charged.
- If the CHARGE/RED indicator does not light up red even though you put the headphones on the transmitter and wait for a while, it may be the end of battery lifetime. You can order the supplied rechargeable battery BP-HP800-11 from the store where you purchased this system, or at your nearest Sony dealer.
- Charging may not be completed if the transmitter’s contact pin and headphones’ contact point are dusty. Wipe them with a cotton bud, etc.

### Short usage time (the supplied rechargeable battery)

- Clean the + and - terminal of the supplied rechargeable battery and the charging terminal of transmitter/headphone with a dry cloth.
- Recharge the supplied rechargeable battery after the fully discharged.

## How to use the headphones

## Specifications

<b>RF stereo transmitter (TMR-RF995R)</b>	
Modulation	FM stereo
Carrier frequency	915.5 MHz, 916.0 MHz, 916.5 MHz
Channel	Ch1, Ch2, Ch3
Transmission distance	Approx. 45 m (150 ft) of longest
Audio inputs	Stereo mini jack
Power requirements	DC 12 V (from the supplied AC adaptor)
Dimensions	Approx. 130 mm × 273 mm × 160 mm (5 1/8 × 10 3/4 × 6 3/8 in) (w/h/d)
Mass	Approx. 265 g (10 oz)
Rated power consumption	2.0 W
Operating temperature	5°C to 35°C (41°F to 95°F)

### Wireless stereo headphones (MDR-RF995R)

Frequency response	10 Hz – 22,000 Hz
Power source	Supplied rechargeable nickel-metal hydride battery BP-HP800-11, or commercially available (LR03 (size AAA)) dry batteries
Mass	Approx. 275 g (10 oz)
Operating temperature	5°C to 35°C (41°F to 95°F)

### Included items

RF stereo transmitter TMR-RF995R
Wireless stereo headphones MDR-RF995R
AC adaptor (12 V) (1)
Stereo mini cable (stereo mini plug), 1.5 m (39 3/8 in) (1)
Card warranty (1)
Operating Instructions (this manual) (1)
Design and specifications are subject to change without notice.