

S.M.S.L

SA400

使用说明书

安全注意事项

注意：

为防电击，请勿打开机盖(或后盖)。
本机内部无使用者可以维修的部件。
请委托有资格的技术人员进行维修。



等边三角形中有箭头闪电标号的图形表示警告使用者在产品内有非绝缘的“危险电压”，可能会对人体造成很大的电击危险。



等边三角形中有感叹号的图形表示警告使用者该设备在操作与维护(维修)方面应严格按照所附设备说明书。



仅适用于海拔2000m以下地区安全使用。

注意：为了完全切断本机的电源，请从墙上插座中拔出插头。电源插头用于完全中断机器的电源供应。

特点

- 内置2片STA516BE数字功率放大器芯片,在4欧姆下每声道输出230W的不失真功率,轻松驱动大部分音箱;
- 使用了日本NJRC公司电子音量控制芯片NJW1195,精准的音量控制和超低的失真度;
- 超低音前级输出,输出-30~+10dB可调,用于连接有源超低音音箱,组成2.1音频系统;
- 内置多种EQ模式和高/低音调节功能,轻松匹配各种喇叭和音乐;
- 高通蓝牙5.0接收,支持APTX,更好的音质,更远的传输距离;
- 全铝合金CNC加工工艺,采用阳极氧化技术,做工精细,触感一流;
- 彩色显示屏和人性化操作系统简单易懂,配备全功能遥控功能;
- 大量采用发烧级音频元件以提升主观听感;
- 高品质镀金输入、输出端子;
- 完善的过热,过流等保护电路;
- 音频专用的高品质电源。

目录

安全注意事项.....	1
特点.....	2
目录.....	3
技术参数.....	5
关于遥控器.....	6
部件介绍.....	7~9
主机前面.....	7
主机背面.....	8~9
显示界面和操作介绍.....	10-11
恢复出厂设置/保修条款.....	12

Table of content

Safety notes.....	13
Features.....	14
Specification.....	15
Remote Control.....	16
Functions.....	17-19
Main unit front.....	17
Main unit back.....	18-19
Operation Instructions.....	20-21
Factory Reset/Warranty Terms.....	22

技术参数

输入接口 XLR, RCA, BT

THD+N 0.003%

信噪比 96dB

通道分离度 94dB

输出功率 230Wx2(4 Ω) / 110Wx2(8 Ω)

消耗功率 50W(正常音量)

体积 210X235X48mm(WxHxD)

重量 1.95 kg

关于遥控器

如果遥控器距离本机很近时操作仍无效，请用新电池更换。

如果要长时间不使用遥控器，请取出遥控器的电池。

按照电池处置的地方性法规处置废旧电池。

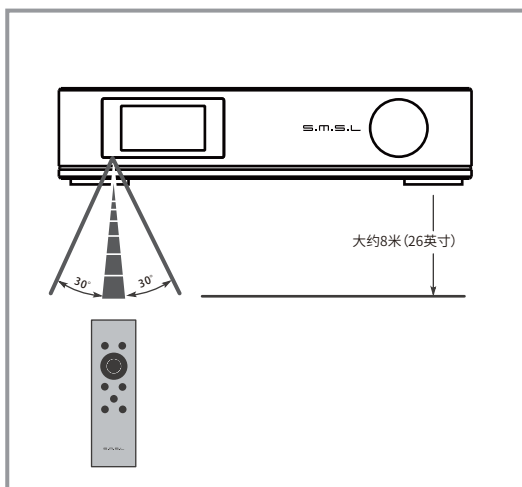
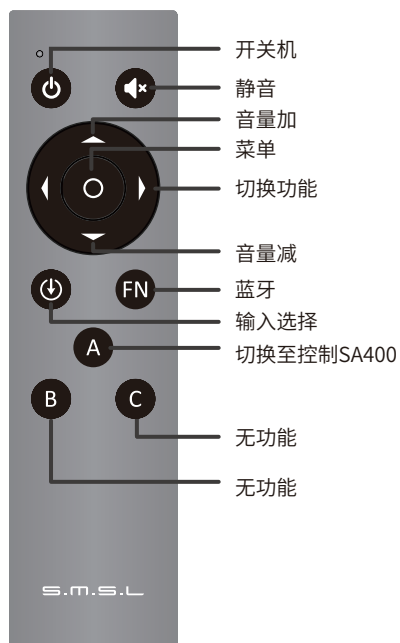

注意

1. 遥控器请使用2节7号(AAA)电池。
2. 第一次操作SA400时，先按A键。

部件介绍

主机前面

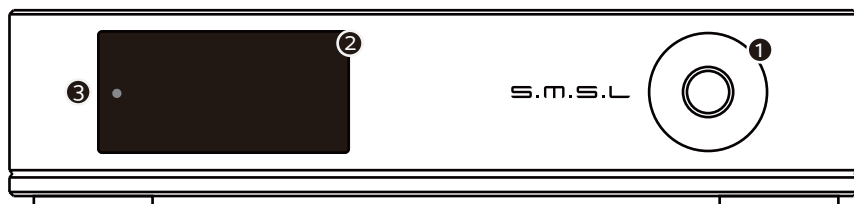

1. 功能旋钮

2. 显示屏

3. 红外遥控接收窗

主机背面

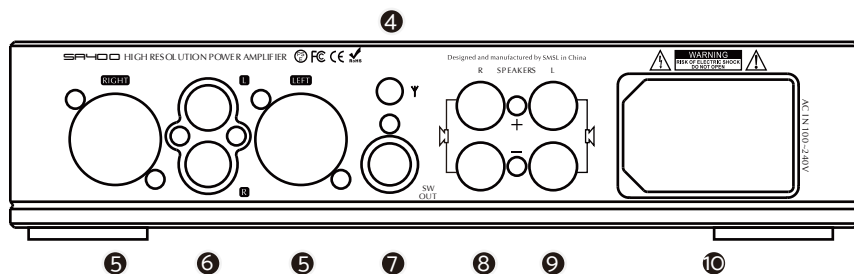

- | | |
|----------|------------------------|
| 4. 蓝牙天线 | 8. 右喇叭输出 |
| 5. 平衡输入 | 9. 左喇叭输出 |
| 6. 线路输入 | 10. 电源输入 (100-240V AC) |
| 7. 超低音输出 | |

显示界面和操作介绍

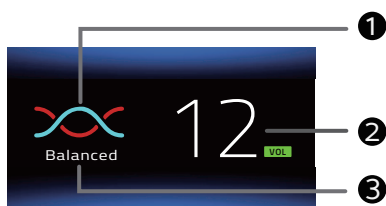

主界面

1. 输入选择图标
2. 音量显示
3. 输入选择状态显示
(静音时显示“MUTTING”)

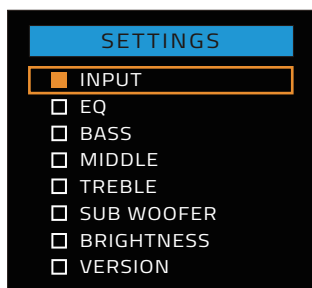

有8页的设置, 屏幕如下图所示

1. INPUT (输入选择)
2. EQ (音效模式)
3. BASS (低音调整)
4. MIDDLE (中音调整)
5. TREBLE (高音调整)
6. SUB WOOFER(超低音输出调整)
7. BRIGHTNESS (亮度)
8. VERSION (版本号)

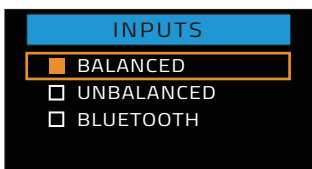

输入菜单

1. BALANCED (平衡输入)
2. UNBALANCED(非平衡输入)
3. BLUETOOTH (蓝牙输入)

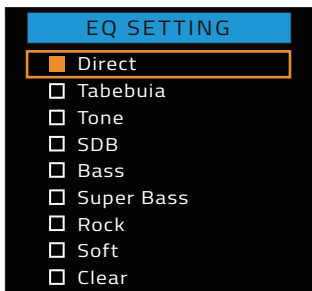

EQ菜单

1. Direct (直通)
2. Tabebuia (风铃木)
3. Tone (自定义)
4. SDB (SM58专利音效)
5. Bass (低音加强音效)
6. Super Bass (低音超强音效)
7. Rock (摇滚乐音效)
8. Soft (柔和音效)
9. Clear (清晰音效)

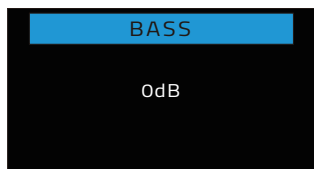

低音调节范围:-12dB ~ +12dB

当EQ处于直通或其他EQ模式时, 调节低音, EQ模式会自动切换到Tone的状态

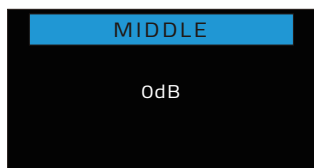

中音调节范围:-12dB ~ +12dB

当EQ处于直通或其他EQ模式时, 调节中音, EQ模式会自动切换到Tone的状态



高音调节范围:-12dB ~ +12dB

当EQ处于直通或其他EQ模式时, 调节高音, EQ模式会自动切换到Tone的状态

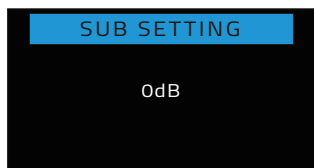

超低音输出调节范围: -30dB ~ +7dB



亮度调节范围: LEVEL 1-6

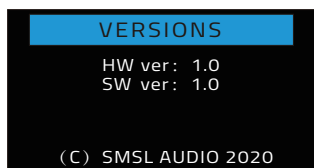

版本号

蓝牙操作说明

本产品配备了**蓝牙按键**,就是遥控器上的**FN按键**,
这个按键的功能包括:

短按: 直接切换到蓝牙输入,如果蓝牙失去连接,则为重新连接;

长按: 断开当前设备,允许配对其它设备

- **连接:** 将输入源切换至蓝牙,打开手机蓝牙功能,搜索“**SMSL BT5.0D**”,搜索到后点击配对连接,当手机显示“已连接”则已连接成功。
- **重连:** 在使用蓝牙过程中,如果失去连接,例如:外出,然后回来,有些手机不会自动重新连接,在这个时候,**短按遥控器的蓝牙按键(FN)**就可以重新连接。
- **连接新设备:** **长按遥控器的蓝牙按键(FN)**。在清除配对后,部分手机可能会出现无法再搜索到“**SMSL BT5.0D**”,此时需要将手机保存的蓝牙设备“**SMSL BT5.0D**”删除掉,然后再搜索配对。

恢复出厂设置

机器在未通电状态下,按住电源键再通电,直到显示屏显示logo之后,松开按键。

保修条款

一、服务期限

佛山双木三林科技有限公司承诺产品的良好品质,产品自售出之后7天内正常使用情况下出现故障,客户可以选择退货或者保修(不影响二次销售才可退货)。正常使用一年内出现故障可以免费保修。

二、购买日期以销售商开出的购机发票或收据日期为准,网购可以交易截图为准。

三、有以下情况都不能享受“三包”服务

- 一切人为因素损坏,包括非正常工作环境下使用或不按照说明书使用;
- 用户私自拆机、改装、维修;
- 使用非指定或许可的配件造成损坏的;
- 机身的QC或保修贴损毁;
- 不能出示有效购机凭证;
- 不属于本公司产品。

四、保修方式为送修

此条款只适于中国大陆,其它地区请参考当地销售代理商的规定和国家法规。

S.M.S.L

Safety notes

CAUTION:

TO REDUCE THE RISK OF ELECTRIC SHOCK,
DO NOT REMOVE COVER(OR BACK).



The lightning flash with arrowhead symbol, with in an equilateral triangle, is intended to alert the user to the presence of uninsulated “dangerous voltage” within the product’s enclosure that may be of sufficient magnitude to constitute a risk of electric shock to persons.



The exclamation point within an equilateral triangle is intended to alert the user to the presence of important operating and maintenance (servicing) instructions in the literature accompanying the appliance.



Safe use only under elevation 2000m.

WARNING:

TO REDUCE THE RISK OF FIRE OR ELECTRIC SHOCK, DO NOT EXPOSE
THIS APPLIANCE TO RAIN OR MOISTURE.

Features

- Use two STA5166 digital power amplifier chips, output 230W per channel at 4 ohm, easy to drive most speakers.
- Using NJRC's electronic volume control chip NJW1195 from Japan, precise volume control and low distortion.
- Super bass preamp output for connecting active subwoofers to form a 2.1 audio system, -30 ~ +10dB adjustment range.
- Built-in multiple EQ modes and treble / bass adjustment for easy matching of a variety of speakers and music.
- Qualcomm Bluetooth 5.0 receiver, support APTX, better sound quality, longer transmission distance.
- All aluminum alloy CNC precision processing shell, anodizing technology and chamfering process, exquisite workmanship and delicate touch.
- Using color LCD screen and newly developed user interface, full-function remote control.
- High quality gold-plated input and output terminals.
- Perfect protection circuit for overheating, overcurrent, etc.
- High quality power specially designed for audio.

Specification

InputsXLR, RCA, BT

THD+N0.003%

SNR96dB

Channel separation94dB

Output Power230Wx2(4 Ω) / 110Wx2(8 Ω)

Power Consumption50W(Normal Volume)

Size210x235x48mm (WxHxD)

Weight1.95kg

Remote Control

Install 2 x AAA batteries as instructions

When using the remote control, point it toward the remote control signal receiver on the main unit from a distance of 5 m (16 ft) or less. Do not place obstructions between the main unit and the remote control.

The remote control might not work if the remote control signal receiver on the unit is exposed to direct sunlight or bright light. If this occurs, try moving the unit. Beware that use of this remote control could cause the unintentional operation of other devices that can be controlled by infra.

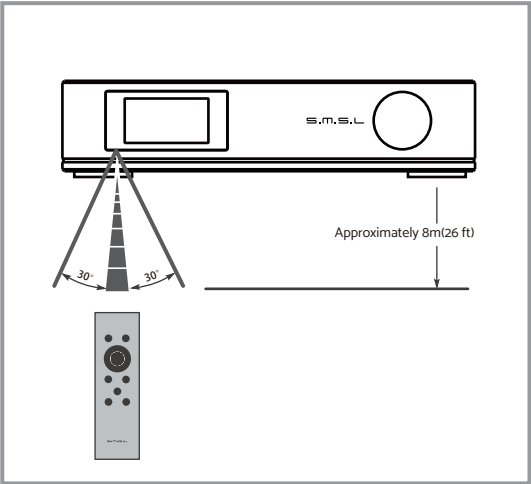
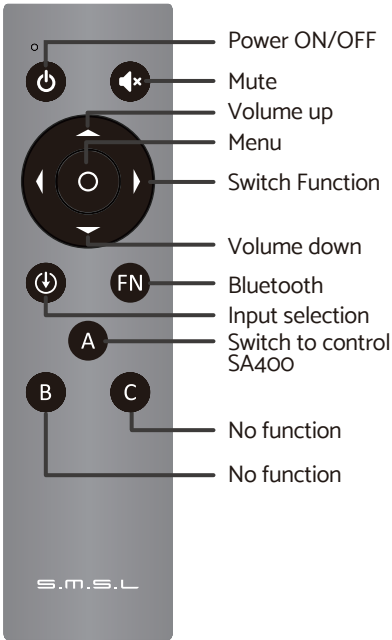

NOTE:
1. This remote controller use 2 x R03/AAA batteries;
2. When you first operate SA400,press the A key first.

Functions

Main unit front

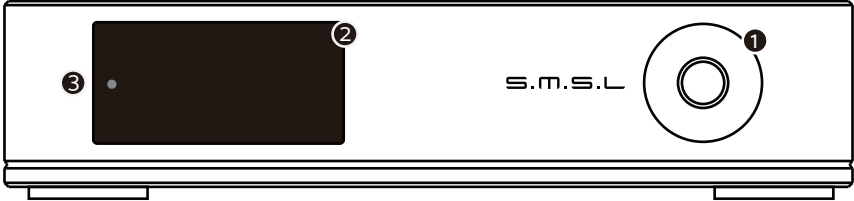

1. Multi-function knob

3. Remote window

2. Display

Main unit back

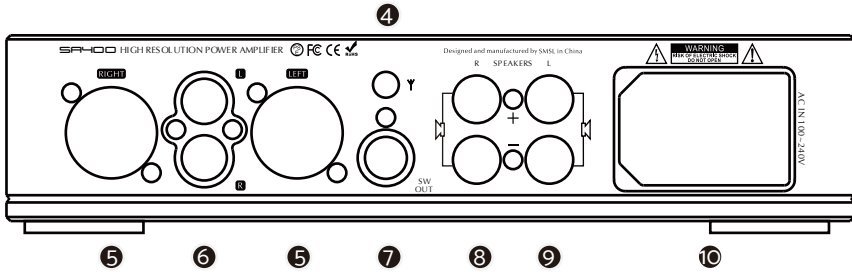

4. Bluetooth antenna

5. XLR

6. Line in

7. SW OUT

8. Right speaker output

9. Left speaker output

10. Power input (100V-24V AC)

Operation Instructions



Main Display

1. Input selection indication
2. Volume
3. Input status(Red when muted)



There are 8 pages of settings in this menu.

1. INPUT
2. EQ
3. BASS
4. MIDDLE
5. TREBLE
6. SUB WOOFER
7. BRIGHTNESS
8. VERSION

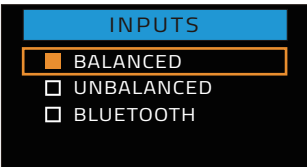

INPUTS

1. BALANCED
2. UNBALANCED
3. BLUETOOTH

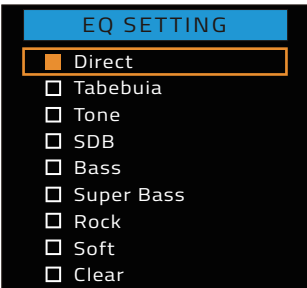

EQ Setting

1. Direct
2. Tabebuia
3. Tone
4. SDB
5. Bass
6. Super Bass
7. Rock
8. Soft
9. Clear

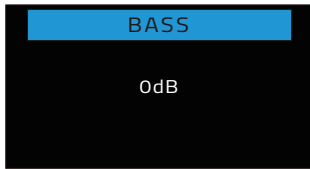

Bass adjustment range: -12dB ~ +12dB

When the EQ mode is Direct or other EQ mode, changing the Bass will change the EQ to Tone mode.

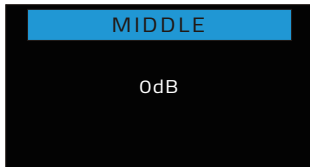

MIDDLE adjustment range: -12dB ~ +12dB

When the EQ mode is Direct or other EQ mode, changing the MIDDLE will change the EQ to Tone mode.



Treble adjustment range: -12dB ~ +12dB

When the EQ mode is Direct or other EQ mode, changing the Treble will change the EQ to Tone mode.

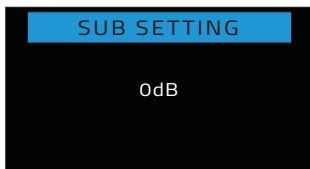

SW OUT adjustment range: -30dB ~ +7dB



Brightness Level: 1 ~ 6

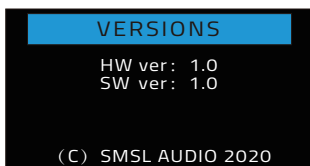

VERSIONS

Bluetooth operating instructions

This product is equipped with a **Bluetooth**

- **Short press:** Switch directly to Bluetooth input, if Bluetooth loses connection, it is a reconnect,
- **Long press:** Disconnect the current device and allow pairing with other devices.

Connection:

- Step 1: Switch the input source in the SETTING MENU or press the Bluetooth button of the remote,
- Step 2: Turn on the Bluetooth function of the mobile phone, search for “**SMSL BT5.0D**”, and tap to pairing. When the mobile phone displays “connected”, it has been successfully connected.

Re-connection:

When you had lost the connection with the SA400, for example, going out, and back home, some phones will not re-connect the SA400 if the SA400 has not been re-boot, so you can **press the Bluetooth button (FN)** on the remote to Re-connect.

Clear pairing: Long press the “Bluetooth” button (FN) on the remote control. After clearing the pairing, some phones may no longer be able to search for “SMSL BT5.0D”. In this case, you need to delete the Bluetooth device “SMSL BT5.0D” which saved in the phone, and then search and pairing again.

Factory Reset

Connect the power cord when pressing the power button, until the screen shows logo.

Warranty Terms

1.The Term of Service

Foshan Shuangmusanlin Technology Co., Ltd promises to offer good-quality products. If the product is broken in 7 days after purchasing when you use it normally, you can choose to send it back for return, replacement or repairing (only the product does not affect the second sales can be returned). Repairing for free in one year if you use it normally.

2.Date of purchase is in accordance with the date on invoice or receipt used by seller, and if you buy it on line, you can show the screenshot of trade.

3.If an inappropriate usage causes the unit damaged, the warranty will be void. As below.

- All damages by inappropriate use, including using it under non-normal working environment or without following the instructions.
- Dismantling, refitting, repairing by user in private.
- Causing damage by using some fittings instead of the designative or accredited ones.
- Cannot provide credible proof of purchase.

4.Sending it back to our company for repairing.

5.Contact your S.M.S.L Audio reseller for a return or replacement.