



SENNHEISER



HDV 820

Digital headphone amplifier

Instruction manual

Contents

Important safety instructions	3
The HVE 820 headphone amplifier	6
Package contents	7
Product overview	8
Overview of the front panel	8
Overview of the rear panel	8
Putting the HDV 820 into operation	9
Setting up the headphone amplifier	9
Connecting the headphone amplifier to audio sources	9
Using the headphone amplifier connected to a Mac/PC	12
Connecting the headphone amplifier to a power amplifier or to active loudspeakers	17
Connecting the headphone amplifier to the power supply system	18
Using the HDV 820	19
Switching the HDV 820 on/off	19
Connecting headphones	20
Selecting the audio source	21
Adjusting the signal level of the RCA input (UNBAL)	22
Adjusting the volume	22
Cleaning and maintaining the HDV 820	23
Installing firmware updates	23
If a problem occurs	24
Specifications	25
Manufacturer Declarations	27



Important safety instructions

1. Read these safety instructions.
2. Keep these safety instructions. Always include these safety instructions when passing the product on to third parties.
3. Heed all warnings.
4. Follow all instructions.
5. Do not use the product near water.
6. Only clean the product when it is not connected to the power supply system. Clean only with a dry cloth.
7. Ensure circulating ventilation. The product generates heat which is dissipated through the housing. Install in accordance with the manufacturer's instructions.
8. Do not install near any heat sources such as radiators, heat registers, stoves, or other products that produce heat and do not expose to direct sunlight.
9. Do not defeat the safety purpose of the polarized or grounding-type plug. A polarized plug has two blades with one wider than the other. A grounding type plug has two blades and a third grounding prong. The wide blade or the third prong are provided for your safety. If the provided plug does not fit into your outlet, consult an electrician for replacement of the obsolete outlet.
10. Protect the power supply cord from being walked on or pinched, particularly at plugs, convenience receptacles, and the point where it exits from the product.
11. Use only attachments/accessories/spare parts supplied or recommended by Sennheiser.
12. Use only with shelves, racks, or tables that can safely support the weight the product (see "Specifications" on page 25).
13. Unplug the product during lightning storms or when unused for long periods of time.
14. Refer all servicing to qualified service personnel. Servicing is required when the product has been damaged in any way, such as power supply cord or plug is damaged, liquid has been spilled or objects have fallen into the product, when the product has been exposed to rain or moisture, does not operate normally, or has been dropped.
15. **WARNING:** To reduce the risk of fire and electric shock, do not expose the product to dripping or splashing and ensure that no objects filled with liquids, such as vases, are placed on the product.
16. To completely disconnect this product from the AC mains, disconnect the power supply cord plug from the AC receptacle.
17. The plug of the power supply cord shall remain readily accessible.



Hazard warnings on the bottom of the product

The label shown on the left is attached to the bottom of the product.

The symbols on this label have the following meaning:

Presence of uninsulated dangerous voltage within the product's enclosure that may be of sufficient magnitude to constitute a risk of fire or electric shock.

Read and follow the safety and operating instructions contained in this instruction manual.

Never open the product. There is a risk of electric shock when touching live parts. There are no user serviceable parts inside the product. Refer repairs to an authorized Sennheiser service partner.

Preventing damage to health and accidents

- ▷ Protect your hearing from high volume levels. Permanent hearing damage may occur when headphones are used at high volume levels for long periods of time. Sennheiser headphones sound exceptionally good at low and medium volume levels.
- ▷ Keep the product, accessories and packaging parts out of reach of children and pets to prevent accidents and choking hazards.
- ▷ Do not use the product in an environment that requires your special attention (e.g. when performing skilled jobs).

Preventing damage to the product and malfunctions

- ▷ Allow the product to stand for at least 2 hours before putting it into operation. Condensation can form inside the product if it is moved from a cold environment to a warm environment.

Notes on the use and disposal of storage media

You can use the supplied USB flash drive for storing personal data. If the flash drive is sold/passed on or disposed of, the data once stored on it and then deleted using a standard delete method can be recovered with special software and be misused.

We therefore recommend using special software for secure deletion of data to ensure that personal data is not misused.

We recommend backing up the data saved on your flash drive regularly. Sennheiser does not accept liability for damage or loss of data.

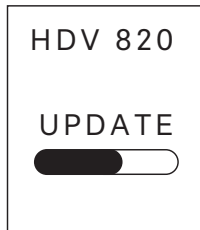

Notes on driver and firmware updates

We recommend using the latest DAC (digital-to-analog converter) firmware for your headphone amplifier and the latest driver for your operating system (MacOS, Windows).

DAC firmware and driver updates can be downloaded free of charge from the Internet at www.sennheiser.com/download or can be obtained from your Sennheiser partner.

Intended use/Liability

This amplifier for dynamic headphones has been designed for music reproduction from analog and digital high-end devices such as SACD, DVD-A, Blu-ray or CD players or for the reproduction of high-resolution music files from your Mac or PC.

This product is intended for private domestic use only. It is not intended for commercial use.

It is considered improper use when this product is used for any application not named in this instruction manual.

Sennheiser is not liable for damages to USB devices that are not consistent with the USB specifications.

Sennheiser does not accept liability for damage arising from abuse or misuse of this product and its attachments/accessories.

Before putting the product into operation, please observe the respective country-specific regulations.

The HVE 820 headphone amplifier

The HDV 820 headphone amplifier is the result of Sennheiser's many years of audio expertise and the perfect complement to its high-end audiophile headphone range for the ultimate in sound quality and performance. The HDV 820 offers consistently symmetrical signal processing and extremely low harmonic distortion to ensure unadulterated and perfect music enjoyment. Designed and manufactured in Germany, the HDV 820 continues the success story of its predecessor, the HDVD 800, and convinces with its black design and enhanced components that provide even greater precision and sound quality.

The HDV 820 is equipped with a high-resolution ESS SABRE³² DAC (digital-to-analog converter) that has a resolution of 32 bits and a sampling rate of up to 384 kHz. The amplifier can also process DSD256 files with a frequency of up to 12.3 MHz and features various audio inputs and outputs, allowing you to choose the optimum connection for your audio devices and headphones. The HDV 820 reproduces both digital and analog audio sources with superb sound quality.

Fittingly for a product that gives such an incredibly pure sound experience, the HDV 820 also inspires by its design. With its black anodized housing and white LEDs, the HDV 820 perfectly matches Sennheiser's HD 800 S flagship high-end headphones to deliver the ultimate audiophile listening experience.

Features

- Symmetrical signal processing with exact signal transmission over the entire frequency spectrum and extremely low harmonic distortion
- Dynamic range of more than 120 dB, wide bandwidth and high transient response due to short signal paths
- Outstanding ESS SABRE³² DAC (digital-analog converter) with a resolution of 32 bits and a sampling rate of up to 384 kHz
- Automatic adjustment of the sampling rate (44.1 kHz to 384 kHz)
- USB Audio (up to 32 Bit/384 kHz and up to DSD256)
- Can be used with up to four dynamic headphones
- 3 balanced headphone sockets (2 x 4.4 mm Pentaconn jack socket, 1 x XLR-4 socket)
- High-quality XLR-3/¼" (6.35 mm) jack combo socket for connection of unbalanced headphones
- High flexibility due to different connection possibilities:
 - Digital inputs: S/PDIF coaxial/optical, USB
 - Analog inputs: balanced XLR-3, unbalanced RCA
- Analog output: balanced XLR-3, level adjustable (for connection of active loudspeakers or a power amplifier)
- Engineered and handcrafted in Germany

Package contents

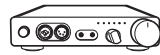

HVE 820 headphone amplifier



Power supply cable
(depending on region; EU, UK, US, CN, KR)

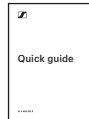

Quick guide



Safety guide

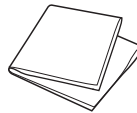

Microfiber cloth



USB flash drive (SD-U16L version) with
instruction manual (as PDF file) and driver software
for Microsoft Windows operating systems



A list of accessories can be found on the HDV 820 product page at www.sennheiser.com. Contact your local Sennheiser partner: www.sennheiser.com > "Sales Partner".

Product overview

Overview of the front panel

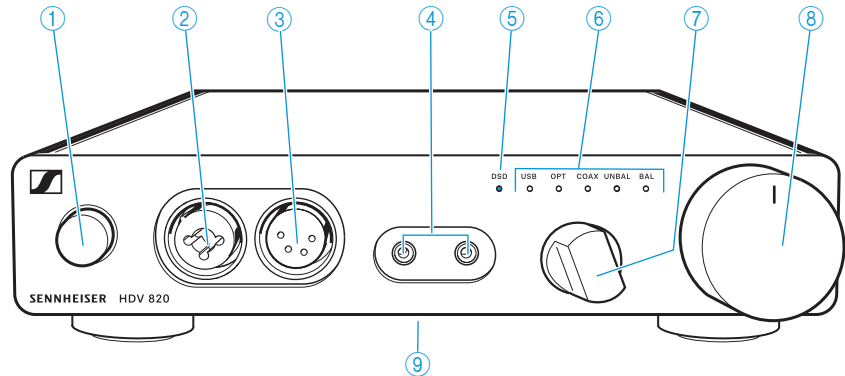

- ① On/off button with LED
- ② Headphone output, XLR-3/¼" (6.35 mm) jack combo socket, unbalanced
- ③ Headphone output, XLR-4 socket, balanced
- ④ Headphone outputs, 4.4 mm Pentaconn jack socket, balanced
- ⑤ DSD reproduction LED
- ⑥ Input selection LED
- ⑦ Input selection rotary switch
- ⑧ Volume control
- ⑨ Type plate (bottom)

Overview of the rear panel

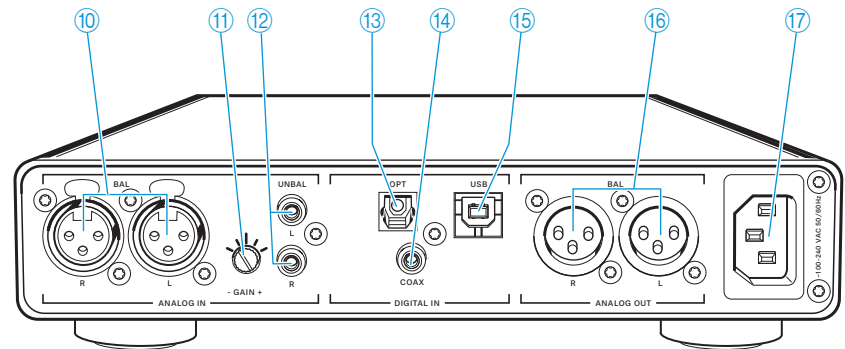

- ⑩ XLR-3 input socket, balanced (BAL R, L)
- ⑪ Input gain rotary switch (-GAIN+) for RCA input
- ⑫ RCA input socket, unbalanced (UNBAL L, R)
- ⑬ S/PDIF input, optical (OPT)
- ⑭ S/PDIF input, coaxial (COAX)
- ⑮ USB input, Type B (USB)
- ⑯ XLR-3 output socket, balanced (BAL R, L)
- ⑰ IEC mains socket ~100-240 VAC 50/60 Hz

Putting the HDV 820 into operation

Setting up the headphone amplifier

CAUTION

Risk of staining of furniture surfaces!

Varnish or furniture polish may degrade the feet of the product, which could stain your furniture.



- ▷ Do not place the product on delicate surfaces; if necessary, use a non-slip pad under the product.

- ▷ Place the headphone amplifier on a flat, horizontal surface.
- ▷ Ensure circulating ventilation. The headphone amplifier generates heat which is dissipated through the housing.

Connecting the headphone amplifier to audio sources

You can connect several audio sources to the headphone amplifier and switch between these connected sources using the *Input selection* rotary switch.

- ▷ Switch your audio sources off before connecting the headphone amplifier.
- ▷ Select a suitable high-quality connection cable for your audio source. For an optimal listening experience, Sennheiser recommends using cables with a length of 3 m.
- ▷ To connect the headphone amplifier to your audio source, refer to the connection diagram suitable for your audio source (see the following chapters):

Connection possibility of the audio source (OUT)		Connection cable	Page	
 DIGITAL	A	USB (USB)	USB 2.0 certified cable with Type A and Type B connector	10
	B	Optical (OPT)	Optical cable	10
	C	Coaxial (COAX)	Coaxial cable (75 Ω)	10
 ANALOG	D	RCA (UNBAL)	Stereo audio cable with 2 RCA connectors at each end	11
	E	XLR-3 (BAL)	2 balanced XLR-3 cables	12

A Connection possibility of the audio source: digital, USB connection

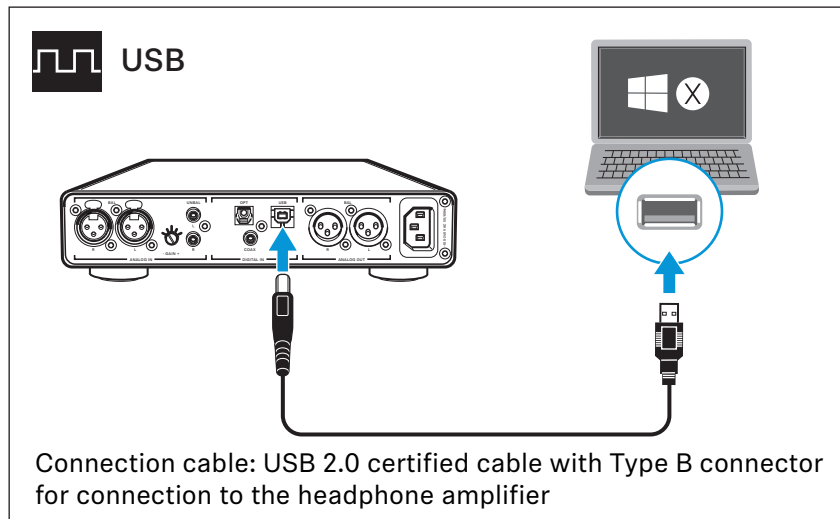

▷ More information on using the headphone amplifier connected to a Mac or PC can be found on page 12.

i For best signal transmission and audio quality, use a USB OTG cable (USB On-the-Go; available from your specialist dealer) to connect your mobile HiRes audio player or smartphone.

B **C** Requirements for digital connections

The digital audio inputs DIGITAL IN (OPT or COAX) can receive digital audio signals in PCM format (supported sampling rates: optical: up to 96 kHz, coaxial: up to 192 kHz).

Information on how to set the audio signal of the connected device to PCM can be found in the Sound or Settings menu or in the instruction manual of your device.

If an incompatible digital audio signal is being received, the *Input selection* LED (OPT or COAX) lights up white and the *DSD reproduction* LED flashes white. Music cannot be reproduced.

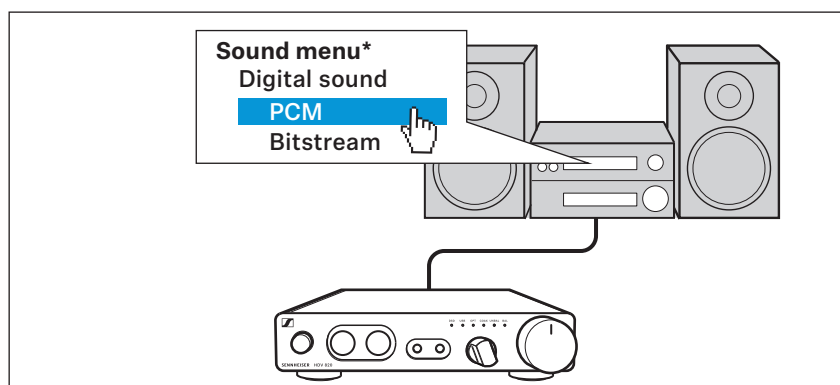

* The appearance of the Sound menu can vary depending on the device you are using.

B Connection possibility of the audio source: digital, coaxial connection

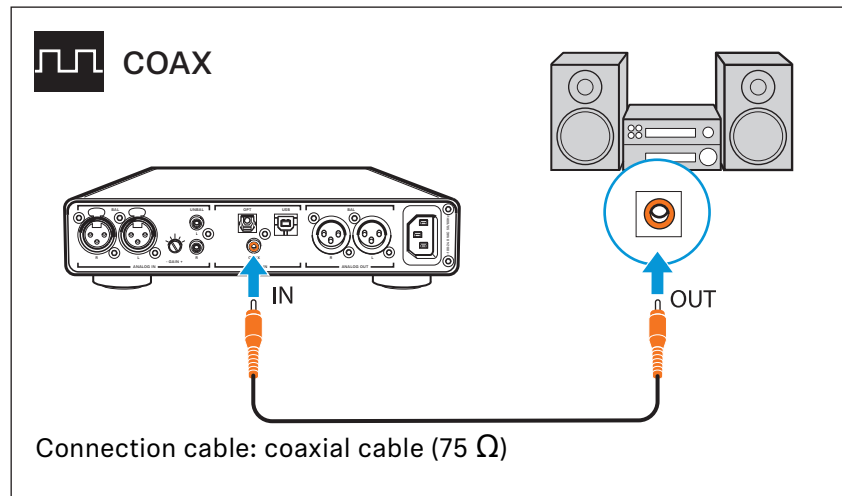

C Connection possibility of the audio source: digital, optical connection

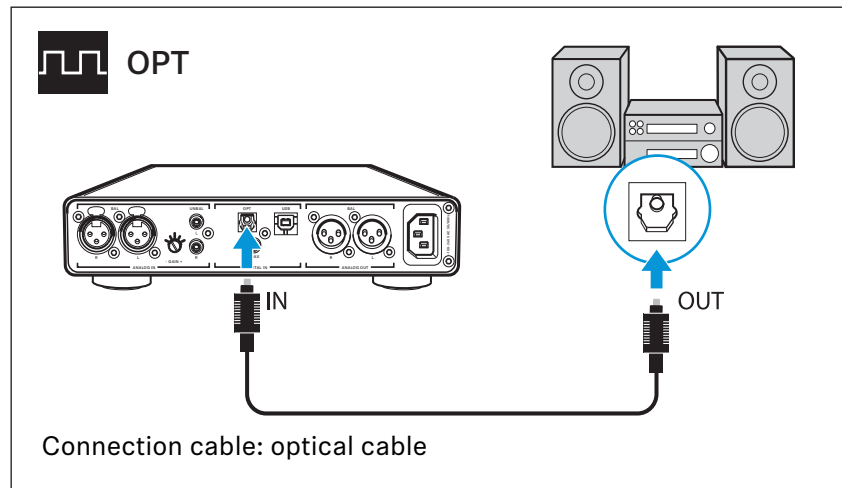

D Connection possibility of the audio source: analog, RCA, unbalanced

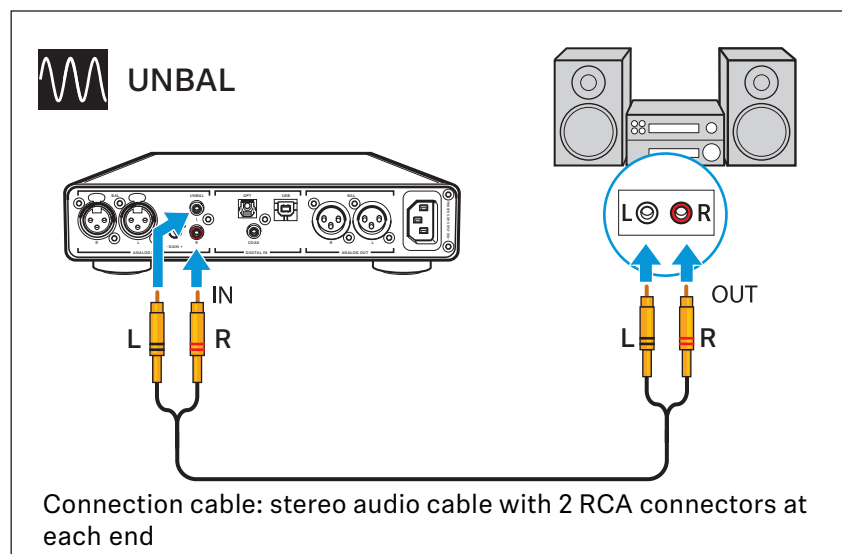

E Connection possibility of the audio source: analog, XLR-3, balanced

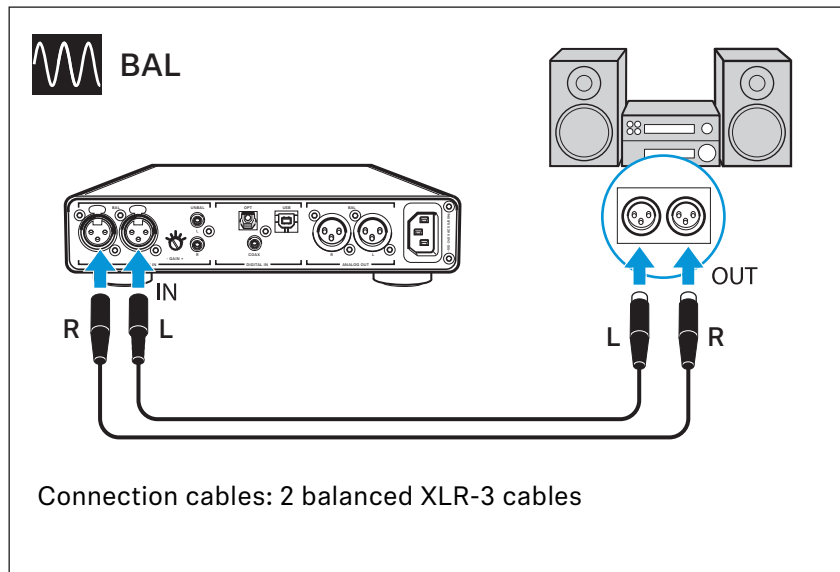

Using the headphone amplifier connected to a Mac/PC

You can connect the HDV 820 via USB (see page 10) directly to your Mac or PC and use it as an audio output device. Depending on the driver and settings used, high-resolution music files can be reproduced via the high-quality DAC (digital-to-analog converter) of the HDV 820.

Notes on DSD reproduction

If you are using your Mac or PC for native reproduction of DSD music files, the *DSD reproduction* LED on the headphone amplifier lights up, indicating the DSD mode of the DAC.

i Information on the possible configuration options for your Mac or PC for native reproduction of DSD music files using third-party software can be found on the HDV 820 product page or at www.sennheiser.com/download.

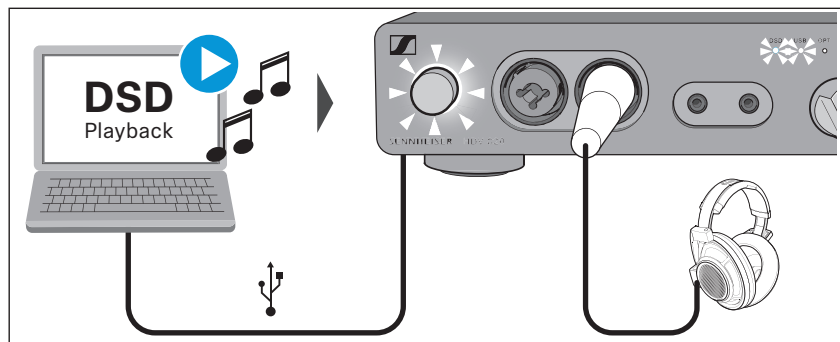

Apple OS X operating system

For an Apple Mac OS X operating system from version 10.6 onwards, you do not have to install a driver. The HDV 820 is recognized automatically.

- ▷ From the System Preferences, select “Sound” and then select “Sennheiser HDV 820” as the default audio output device.

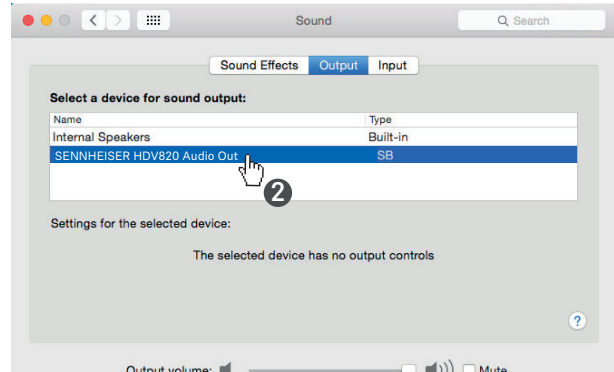

- ▷ Open the “Audio Midi Setup” utility program and select “Sennheiser HDV 820” from the left-side column.

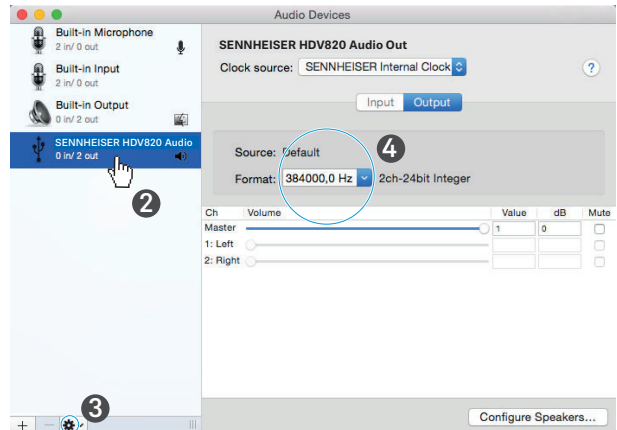
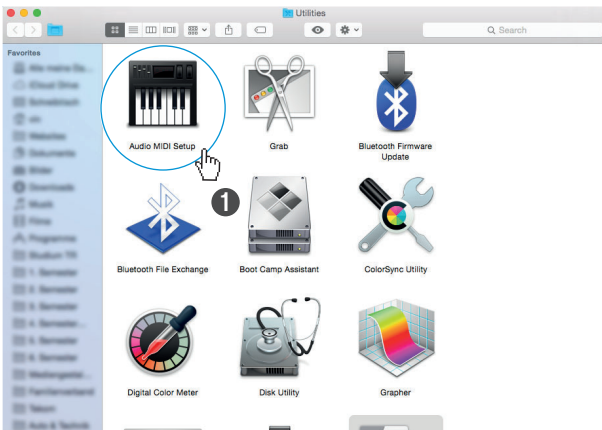

- ▷ From the drop-down menu, select “Use this device for sound output”.
- ▷ In the device settings, select the maximum sample rate from the “Format” drop-down list. Select “384000 Hz” for the best possible sound quality.

Microsoft Windows operating system

If you use a Microsoft Windows operating system, you have to install USB Audio drivers that come with the “HDV 820 USB Audio Software Package”. After installation of the drivers, the HDV 820 is recognized automatically.

System requirements

- Intel Core 2 processor with 1.6 GHz (minimum) or similar processor
- 2 GB RAM (minimum)
- Microsoft Windows 7/8/8.1/10 operating system (32 or 64 bits)
- HDV 820 USB Audio Software Package

The software package contains the following components:

- WDM USB audio driver
- ASIO USB audio driver
- Control Panel
- HDV 820 Updater

Notes on the USB audio modes

If you use standard software (e.g. Windows Media Player or Apple iTunes), the best possible transmission mode is limited by the operating system (the played music file is mixed with System Sounds and adapted to the sample rate and bit depth set for the WDM driver).

For native reproduction of high-resolution files (without driver-induced adaptation of sample rate and bit depth; 32 bits/up to 384 kHz or DSD files), you require an ASIO driver and special third-party software, which transmits the music file natively from the player software to the DAC of the HDV 820 (see page 12).

Example: Microsoft Windows 10

To install the “HDV 820 USB Audio Software Package” and to set the HDV 820 as the default audio output device:

- ▷ Install the “HDV 820 USB Audio Software Package” from the USB flash drive (supplied). The software package can also be downloaded from the Internet at www.sennheiser.com/download or be obtained from your Sennheiser partner. You need administrator rights for installation.
- ▷ Open the Control Panel and select “Sound”.

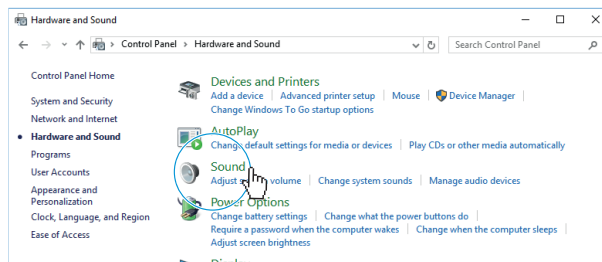

The “Sound” window opens.

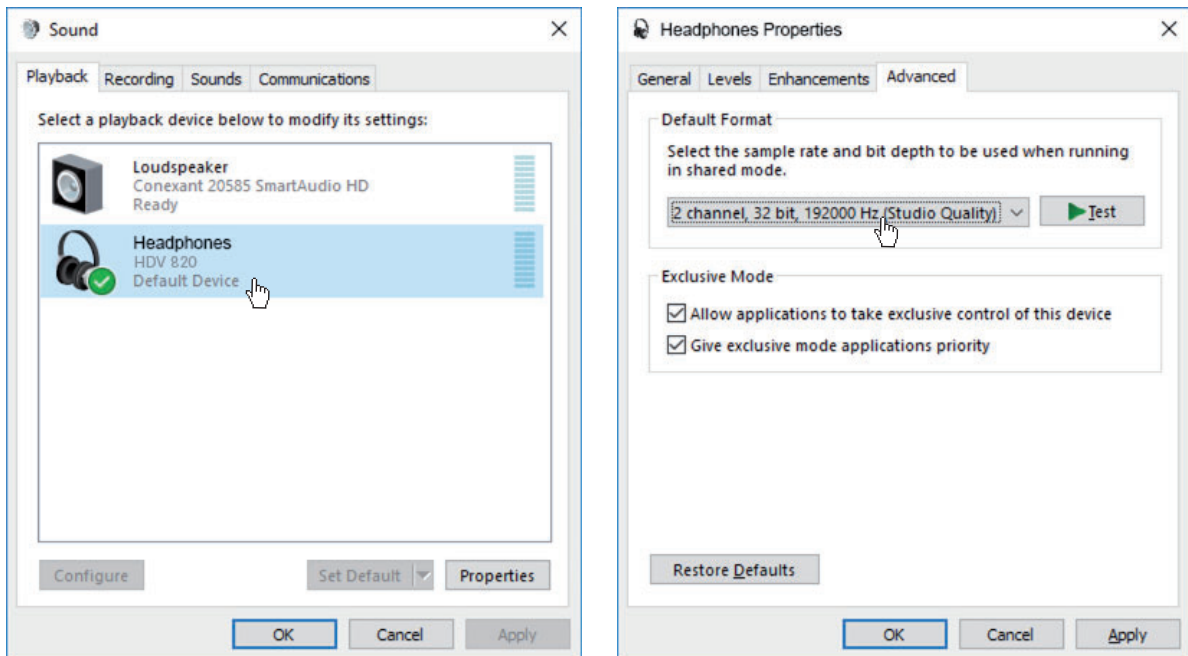

- ▷ Select “HDV 820” as the default audio output device.
- ▷ Click on “Properties” and, in the “Advanced” tab, select the maximum sample rate from the “Default Format” drop-down list. Select “32 bit, 192000 Hz (studio quality)” for the best possible sound quality.
- ▷ Click on “OK” to apply the settings.

Using the Sennheiser Control Panel

The Control Panel allows you to configure the HDV 820 for the reproduction of high-resolution music files and to monitor the current operating state.

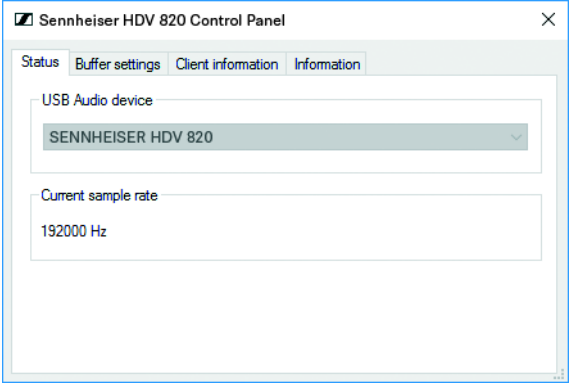
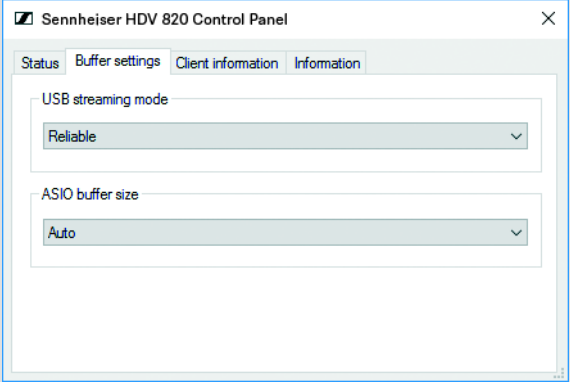
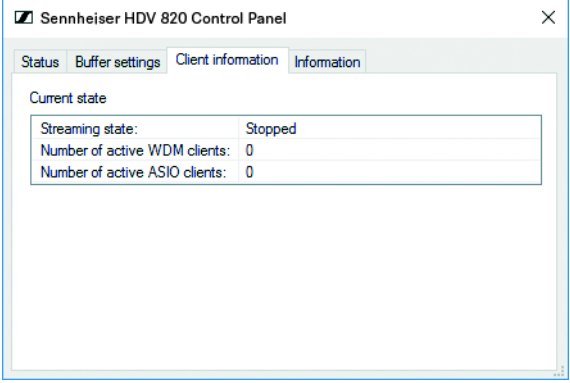
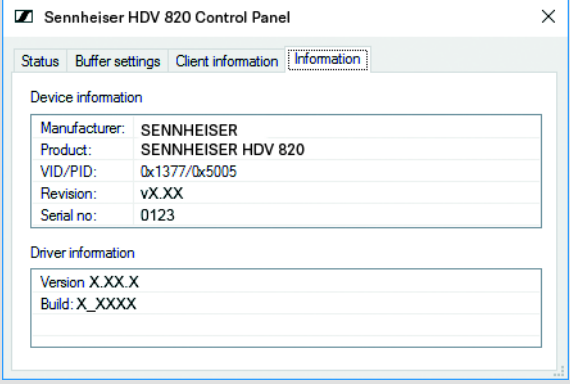
Tab	Control Panel view															
Status	 <p>The screenshot shows the 'Status' tab of the Sennheiser HDV 820 Control Panel. It features a dropdown menu for 'USB Audio device' with 'SENNHEISER HDV 820' selected, and a text field for 'Current sample rate' showing '192000 Hz'.</p>	<p>USB Audio device Currently connected and used device. If several devices are connected simultaneously, you can select the desired device here.</p>														
		<p>Current sample rate PCM: 44100, 48000, 88200, 96000, 176400, 192000, 352800, 384000 Hz DSD: 2822400, 5644800, 11289600 Hz</p>														
Buffer settings	 <p>The screenshot shows the 'Buffer settings' tab. It includes a dropdown for 'USB streaming mode' set to 'Reliable' and another dropdown for 'ASIO buffer size' set to 'Auto'.</p>	<p>USB streaming mode The buffer of the USB streaming mode controls the latency of the music signal from the file source (PC client) and the DAC (HDV 820). The lower the latency, the more CPU power the PC client has to allocate to this process. Recommended setting: "Reliable".</p>														
		<p>ASIO buffer size The ASIO buffer size controls the data transfer between the driver and the playback software. The ASIO buffer size depends on the buffer of the USB streaming mode. Recommended setting: "Auto".</p>														
Client information	 <p>The screenshot shows the 'Client information' tab. It displays a table with the following data:</p> <table border="1" data-bbox="300 1395 809 1462"> <thead> <tr> <th colspan="2">Current state</th> </tr> </thead> <tbody> <tr> <td>Streaming state:</td> <td>Stopped</td> </tr> <tr> <td>Number of active WDM clients:</td> <td>0</td> </tr> <tr> <td>Number of active ASIO clients:</td> <td>0</td> </tr> </tbody> </table>	Current state		Streaming state:	Stopped	Number of active WDM clients:	0	Number of active ASIO clients:	0	<p>Current state Information on the PC client on which the Control Panel is installed and on the streaming state ("Active" or "Stopped"). The type of driver used is displayed via the number of active WDM or ASIO clients.</p>						
Current state																
Streaming state:	Stopped															
Number of active WDM clients:	0															
Number of active ASIO clients:	0															
Information	 <p>The screenshot shows the 'Information' tab. It contains two sections: 'Device information' and 'Driver information'.</p> <p>Device information</p> <table border="1" data-bbox="300 1803 809 1915"> <tbody> <tr><td>Manufacturer:</td><td>SENNHEISER</td></tr> <tr><td>Product:</td><td>SENNHEISER HDV 820</td></tr> <tr><td>VID/PID:</td><td>0x1377/0x5005</td></tr> <tr><td>Revision:</td><td>vX.XX</td></tr> <tr><td>Serial no.:</td><td>0123</td></tr> </tbody> </table> <p>Driver information</p> <table border="1" data-bbox="300 1960 809 2027"> <tbody> <tr><td>Version:</td><td>X.XX.X</td></tr> <tr><td>Build:</td><td>X_XXXX</td></tr> </tbody> </table>	Manufacturer:	SENNHEISER	Product:	SENNHEISER HDV 820	VID/PID:	0x1377/0x5005	Revision:	vX.XX	Serial no.:	0123	Version:	X.XX.X	Build:	X_XXXX	<p>Device information/Driver information Information on the currently connected device and the driver.</p>
Manufacturer:	SENNHEISER															
Product:	SENNHEISER HDV 820															
VID/PID:	0x1377/0x5005															
Revision:	vX.XX															
Serial no.:	0123															
Version:	X.XX.X															
Build:	X_XXXX															

Connecting the headphone amplifier to a power amplifier or to active loudspeakers

You can use the headphone amplifier as a preamplifier and connect it to a power amplifier or to active loudspeakers using analog XLR-3 cables. The output level can be adjusted via the *Volume* control.

- ▷ Switch your audio devices off before connecting the headphone amplifier.

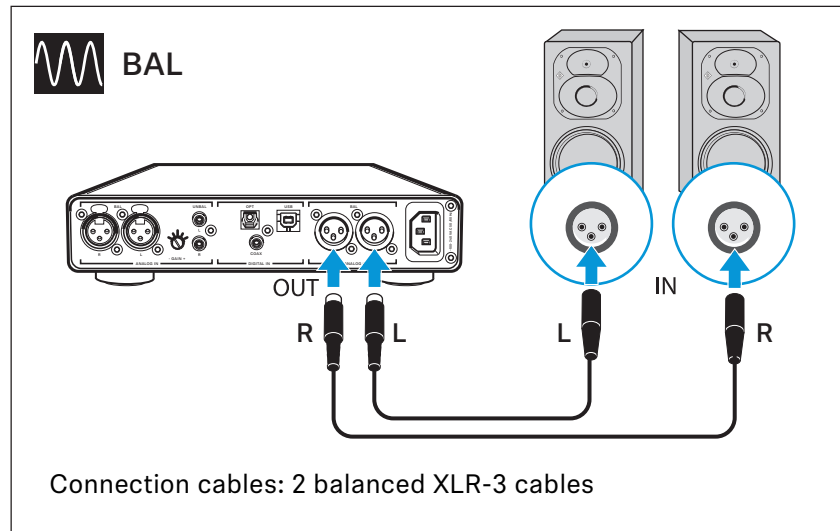

Connecting the headphone amplifier to the power supply system

CAUTION

Danger of damage to the product!

If you connect to an unsuitable power supply, the product can be damaged.

- ▷ Use a suitable power cable (supplied) to connect the product to the power supply system (100 to 240 V AC, 50 or 60 Hz).
- ▷ Connect a suitable power cable (supplied) to the IEC mains socket and a wall socket.

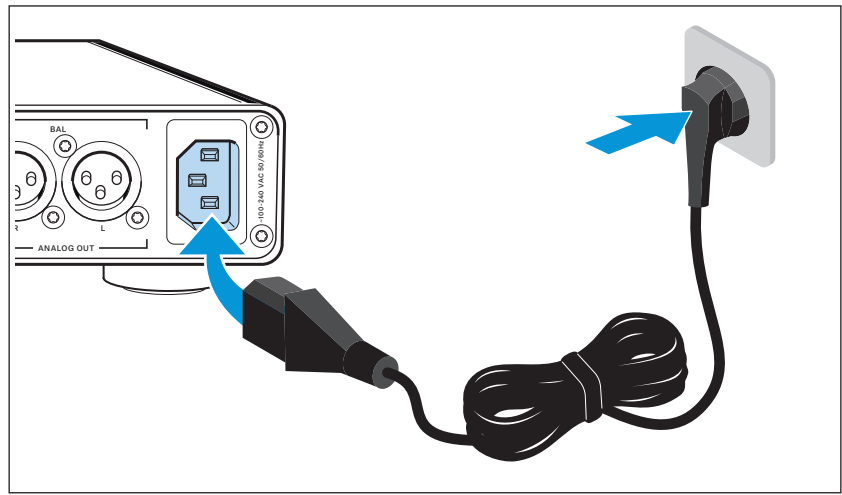

To completely disconnect the headphone amplifier from the power supply system:

- ▷ Unplug the power supply unit from the wall socket.

Using the HDV 820

Switching the HDV 820 on/off



WARNING

Danger of hearing damage!

Listening at high volume levels for long periods of time can lead to permanent hearing defects.

- ▷ Before putting your headphones on, adjust the volume to a low level (see page 22).
- ▷ Do not continuously expose yourself to high volume levels.

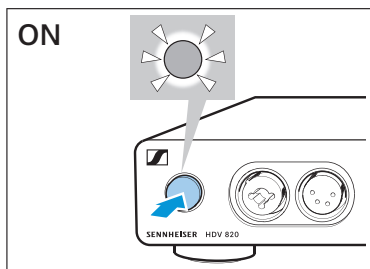

To switch the HDV 820 on:

- ▷ Press the on/off button.
When the headphone amplifier is switched on, the on/off button is backlit in white.

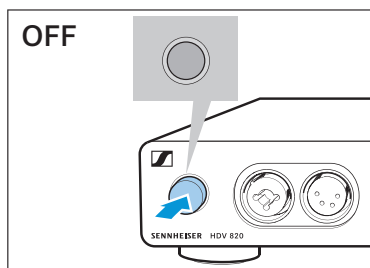

To switch the HDV 820 off after use:

- ▷ Press the on/off button.
The headphone amplifier and all LEDs go off.

To completely disconnect the HDV 820 from the power supply system:

- ▷ Unplug the power plug from the wall socket,

Connecting headphones

The HDV 820 features a total of 4 headphone sockets for dynamic headphones:

- 1 unbalanced XLR-3/¼" (6.35 mm) jack combo socket
- 1 balanced XLR-4 socket
- 2 balanced 4.4 mm Pentaconn jack sockets

The volume setting and the settings of the audio source apply to all headphones. For an optimal listening experience, Sennheiser recommends using high-impedance headphones and cables with a length of 3 m.

▷ Connect one or several pairs of headphones.

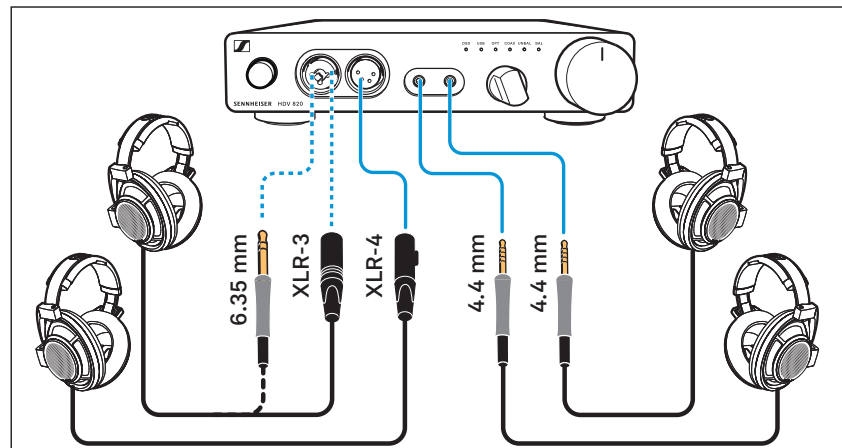

Selecting the audio source



WARNING

Danger of hearing damage!

Before switching to a different audio source, first set the volume on the headphone amplifier to a low level. Different audio sources and different listening material (e.g. different pieces of music on different CDs/sound carriers) can have widely varying signal levels. In the case where you switch to a higher level audio source from a lower one without first reducing the volume level this can lead to high volume levels in the headphones and could damage your hearing.

- ▷ Set the volume on the headphone amplifier to a low level (see page 22) before switching to a different audio source.

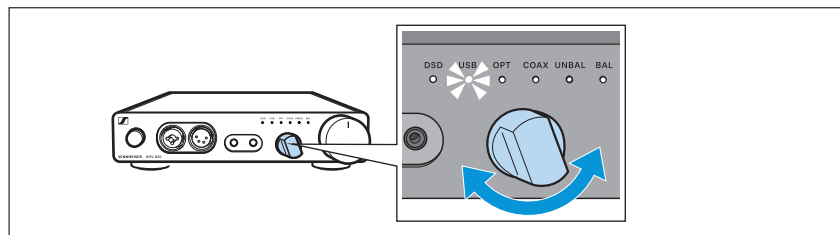

- ▷ Use the *Input selection* rotary switch to select your connected audio source.
The *Input selection* LED lights up white, indicating the selected audio source.

Selection	Selected audio source on the headphone amplifier
USB	USB (digital), the <i>DSD reproduction</i> LED might also light up white (see page 12)
OPT	Optical (digital)
COAX	Coaxial (digital)
UNBAL	RCA (analog)
BAL	XLR-3 (analog)

Adjusting the signal level of the RCA input (UNBAL)

In order to optimally set the gain of the headphone amplifier, you can use the input gain rotary switch to adjust the signal level of the RCA input (UNBAL).

- ▷ Turn the input gain rotary switch (**- GAIN +**) towards the
 - + sign: if the signal is too low or
 - sign: if the signal is overmodulated.

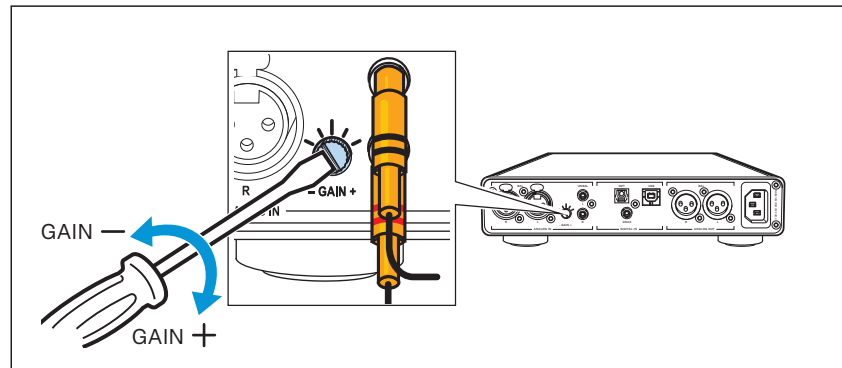

Adjusting the volume



WARNING

Danger of hearing damage!

Listening at high volume levels for long periods of time can lead to permanent hearing defects.

- ▷ Before putting your headphones on, adjust the volume to a low level.
- ▷ Do not continuously expose yourself to high volume levels.
- ▷ Use the *Volume* control to adjust the desired volume.

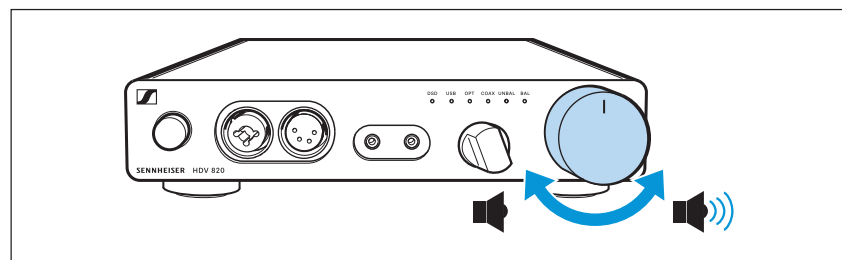

The volume setting applies to the headphone connections and the audio outputs (**ANALOG OUT**). If you have connected several identical headphones to the headphone amplifier, the volume setting applies to all headphones.

Cleaning and maintaining the HDV 820

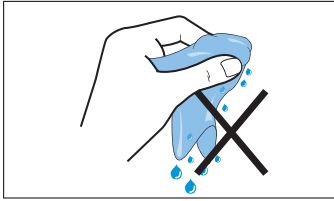

CAUTION

Liquids can damage the electronics of the product!

Liquids entering the housing of the product can cause a short-circuit and damage the electronics.

- ▷ Keep all liquids far away from the product.
 - ▷ Do not use any solvents or cleansing agents.
-
- ▷ Disconnect the product from the power supply system before cleaning.
 - ▷ Clean the product with a soft, dry cloth (supplied).

Installing firmware updates

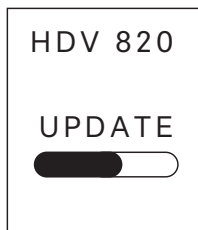

The DAC (digital-to-analog converter) firmware can be updated using the free of charge “Sennheiser HDV 820 Updater” program. The program can be downloaded from the Internet at www.sennheiser.com/download or obtained from your Sennheiser partner. The program is available for Windows and Mac operating systems.

- ▷ Make sure that the HDV 820 is connected to your Mac or PC via USB and that it is switched on.
- ▷ From Windows or MacOS, start the “Sennheiser HDV 820 Updater” program and follow the instructions on the screen.
- ▷ The program automatically checks if the new DAC firmware is compatible with your HDV 820. If this is the case, the program guides you through the installation steps and then confirms successful installation.

If a problem occurs ...

Problem	Possible cause	Corrective action	Page
No audio signal	The HDV 820 is switched off	Switch the HDV 820 on.	19
	The <i>Input selection</i> rotary switch is set to a different audio source	Set the <i>Input selection</i> rotary switch to the desired audio source.	21
	The <i>Input selection</i> rotary switch is between two positions	Set the <i>Input selection</i> rotary switch to one of the two inputs.	21
	The volume is adjusted to low	Increase the volume.	22
No sound when the digital input (OPT or COAX) is selected	The data format of the digital audio source is not PCM	Set the audio source to PCM data format.	–
The audio signal is very low or distorted when an analog audio source is connected	The volume of the audio signal on the audio source is adjusted too low or too high	If possible, adjust the volume of the audio signal on the audio source to a medium level.	–
	The signal level of the audio input is adjusted too low/too high	Increase or reduce the signal level of the ANALOG IN UNBAL audio input.	22
Audio signal only on one ear	The analog audio cable is not properly connected	Properly connect the audio cable to the audio device.	9
	The headphone plug is not properly connected	Properly connect the headphones to the headphone amplifier.	20
The PC does not recognize the HDV 820 as the audio output device	No driver is installed	Install the USB Audio driver.	12
No audio signal when the HDV 820 is connected to a PC or Mac via USB	Another audio output device is selected on the PC or Mac	Select “Sennheiser HDV 820” as the audio output device.	12
Sound dropouts when connected via USB	The USB cable is not sufficiently shielded	Use a USB cable that is at least USB 2.0 certified.	–

If a problem occurs that is not listed in the above table or if the problem cannot be solved with the proposed solutions, please contact your Sennheiser partner for assistance.

To find a Sennheiser partner in your country, search at www.sennheiser.com > “Service & Support”.

Specifications

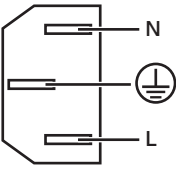
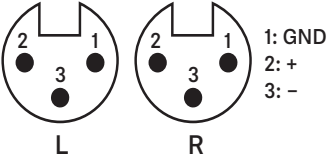
Dimensions (W x H x D)	approx. 224 x 44 x 306 mm
Weight	approx. 2.25 kg
Max. output power	approx. 480 mW @ 1 kHz and 600 Ω load at the XLR-4 output
Frequency response	< 10 Hz to > 100 kHz
Crosstalk attenuation	min. 93 dB @ 1 kHz
THD + N	< 0.001 %
Gain UNBAL input/XLR-4 output	adjustable 14 dB, 22 dB, 30 dB, 38 dB, 46 dB
Gain BAL input/XLR-4 output	16 dB
Dynamic range	> 115 dB @ 600 Ω load (A-weighted)
Temperature range	operation: 5 to 45 °C storage: -20 to 70 °C
Relative air humidity (non-condensing)	operation: 10 to 80 % storage: 10 to 90 %
Power supply	
Voltage range	100 – 240 V ~, 50 – 60 Hz
Power consumption	12 W nominal (2 x 300 Ω headphones connected to the 4.4 mm outputs) max. 18 W (2 x 16 Ω headphones connected to the 4.4 mm outputs)
Pin assignment of IEC mains socket	
Analog input BAL (XLR-3)	
Pin assignment	
Max. input level	18 dBV
Input impedance	20 k Ω
Analog input UNBAL (RCA)	
Max. input level	20 dBV (with minimum amplification GAIN)
Input resistance	10 k Ω
Digital inputs COAX/OPT (coaxial/optical)	
Standard	S/PDIF
Supported data streams	PCM

Supported sample rates	coaxial/optical: 44.1; 48; 88.2; 96 kHz
	coaxial: 176.4; 192 kHz

Digital input USB (USB Type B)

USB standard	min. USB 2.0
USB audio class	USB Audio Class 2
Supported file formats	PCM: 32 bits, 44.1; 48; 88.2; 96; 176.4; 192; 352.8; 384 kHz
	DSD: 64 (2,822,400 Hz), 128 (5,644,800 Hz), 256 (11,289,600 Hz),

Analog output BAL (XLR-3)

Pin assignment	
Max. output level	20 dBV
Output impedance	270 Ω

Headphone output (¼" (6.35 mm) jack socket)

Pin assignment	
Impedance	min. 16 Ω

Headphone output (XLR-3)

Pin assignment	
Impedance	min. 16 Ω

Headphone output (XLR-4)

Pin assignment	
Impedance	min. 16 Ω

Headphone outputs (Pentaconn, 4.4 mm)

Pin assignment	
Impedance	min. 16 Ω

Manufacturer Declarations

Warranty

Sennheiser electronic GmbH & Co. KG gives a warranty of 24 months on this product.

For the current warranty conditions, please visit our website at www.sennheiser.com or contact your Sennheiser partner.

FOR AUSTRALIA ONLY

Sennheiser's goods come with guarantees that cannot be excluded under the Australian Consumer Law. You are entitled to a replacement or refund for a major failure and compensation for any other reasonably foreseeable loss or damage. You are also entitled to have the goods repaired or replaced if the goods fail to be of acceptable quality and the failure does not amount to a major failure. This warranty is in addition to other rights or remedies under law. Nothing in this warranty excludes, limits or modifies any liability of Sennheiser which is imposed by law, or limits or modifies any remedy available to the consumer which is granted by law.

To make a claim under this warranty, contact Sennheiser Australia Pty Ltd, Unit 3, 31 Gibbes Street, Chatswood NSW 2067, AUSTRALIA
Phone: (02) 9910 6700, email: service@sennheiser.com.au.

All expenses of claiming the warranty will be borne by the person making the claim.

The Sennheiser International Warranty is provided by Sennheiser Australia Pty Ltd (ABN 68 165 388 312), Unit 3, 31 Gibbes Street, Chatswood NSW 2067 Australia.

In compliance with the following requirements

- WEEE Directive (2012/19/EU)



The symbol of the crossed-out wheeled bin indicates that disposal of this product via municipal waste is not permitted at the end of its operational lifetime. Waste of electrical and electronic equipment (WEEE) needs to be disposed of separately in accordance with the national/communal regulations. The product can be disposed of at a collection point for electrical and electronic waste in your area.

The separate collection of electrical and electronic equipment is used to promote reuse, material recycling or other forms of recycling of WEEE and to avoid potential effects that may be caused by the presence of hazardous substances. Herewith you make an important contribution to the protection of our environment and human health.

EU declaration of conformity

- EMC Directive (2014/30/EU)
- ErP Directive (2009/125/EC)
- Low Voltage Directive (2014/35/EU)
- RoHS Directive (2011/65/EU)



The declaration is available at www.sennheiser.com/download.

Statements regarding FCC and Industry Canada
Déclaration requise par la FCC et l'Industrie Canada

FCC Declaration of Conformity (DoC)	
We,	 SENNHEISER Model No: HDV 820, SD-U16L
	Sennheiser Electronic Corporation One Enterprise Drive • Old Lyme • CT 06371 • USA Tel: +1 (860) 434 9190 Fax: +1 (860) 434 1759
declare the above device comply with the requirements of Federal Communications Commission.	
This device complies with Part 15 of the FCC rules. Operation is subjected to the following two conditions: 1) This device may not cause harmful interference, and 2) This device must accept any interference received, including interference that may cause undesired operation.	
Responsible Party: Markus Warlitz	

This device complies with Part 15 of the FCC rules. Operation is subject to the following two conditions: 1) this device may not cause harmful interference, and 2) this device must accept any interference received, including interference that may cause undesired operation.

Changes or modifications made to this equipment not expressly approved by Sennheiser electronic Corp. may void FCC authorization to operate this equipment.

Cet appareil est conforme à la Partie 15 des réglementations de la FCC. L'utilisation de l'appareil doit respecter les deux conditions suivantes : (1) L'appareil ne doit pas produire d'interférences nuisibles, et, (2) il doit accepter toutes interférences reçues, y compris celles qui pourraient avoir des effets non désirés sur son fonctionnement. Toute modification non expressément approuvée par Sennheiser electronic Corp. peut annuler le droit de l'utilisateur à l'emploi de l'équipement en question.

Trademarks and licenses

Sennheiser is a registered trade mark of Sennheiser electronic GmbH & Co. KG.

ASIO is a registered trademark of Steinberg Media Technologies GmbH.

Other product and company names mentioned in this instruction manual may be the trademarks or registered trademarks of their respective holders.



Sennheiser electronic GmbH & Co. KG
Am Labor 1, 30900 Wedemark, Germany
www.sennheiser.com

Publ. 11/19, 570794/A02