

**Evo 75**  
**Evo 150**

ALL IN ONE PLAYER



# Contents

IMPORTANT SAFETY INSTRUCTIONS	3
REAR PANEL CONNECTIONS	6
FRONT PANEL CONTROLS	7
REMOTE CONTROL	8
REPLACEABLE SIDE PANELLING	8
OVERVIEW	9
GETTING CONNECTED	9
ADVANCED USB AUDIO	10
BALANCED AUDIO CONNECTIONS (EVO 150 ONLY)	10
USB AUDIO CONNECTION (EVO 150 ONLY)	10
GETTING CONNECTED	11
OPERATING INSTRUCTIONS	12
PRESETS	12
HOW TO USE RADIO	12
MUSIC LIBRARY	12
USB MEDIA	13
INPUTS	13
BLUETOOTH AUDIO STREAMING	13
SPOTIFY	13
AIRPLAY	13
CHROMECAST BUILT-IN	13
SETTINGS	14
SET-UP WI-FI	14
ENTER THE NETWORK NAME	14
UPDATE FIRMWARE	15
AUDIO	15
USB AUDIO CLASS	15
AUDIO OUTPUT	15
BLUETOOTH AUDIO OUTPUT	15
STANDBY MODE	15
NETWORK STANDBY ON	15
AUTOMATIC POWER DOWN	15
LANGUAGE	16
DISPLAY BRIGHTNESS	16
FACTORY RESET	16
STREAMMAGIC APP	16
TECHNICAL SPECIFICATIONS	17
TROUBLESHOOTING	18

This guide is designed to make installing and using this product as easy as possible. Information in this document has been carefully checked for accuracy at the time of printing; however, Cambridge Audio's policy is one of continuous improvement, therefore design and specifications are subject to change without prior notice.

This document contains proprietary information protected by copyright. All rights are reserved. No part of this manual may be reproduced by any mechanical, electronic or other means, in any form, without prior written permission of the manufacturer. All trademarks and registered trademarks are the property of their respective owners.

The Bluetooth® word mark and logos are registered trademarks owned by the Bluetooth SIG, Inc. and any use of such marks by Audio Partnership Plc is under license. Other trademarks and trade names are those of their respective owners.

Qualcomm is a trademark of Qualcomm Incorporated, registered in the United States and other countries, used with permission.

aptX is a trademark of Qualcomm Technologies International, Ltd., registered in the United States and other countries, used with permission. Qualcomm aptX is a product of Qualcomm Technologies International, Ltd

Stream Magic is a trademark of Audio Partnership Plc and is registered in the European Community and other countries.

This product contains software licensed under version 2 of the GNU Public License and version 2.1 of the GNU Lesser Public License. The source code for this software is available from:

<http://gpl.stream-magic.com/>

This product includes technology owned by Microsoft Corporation and under a licence from Microsoft Licensing GP. Use or distribution of such technology outside of this product is prohibited without a license from Microsoft Corporation and/or Microsoft Licensing, GP as applicable.

The Spotify software is subject to third party licenses found here: [www.spotify.com/connect/third-party-licenses](http://www.spotify.com/connect/third-party-licenses).

This Evo 75/Evo 150 support AirPlay 2 and requires iOS 11.4 or later.

Apple and AirPlay are trademarks of Apple Inc., registered in the U.S. and other countries.

Use of the Works with Apple badge means that an accessory has been designed to work specifically with the technology identified in the badge and has been certified by the developer to meet Apple performance standards.

Android, Google Play and the Chromecast built-in logo are trademarks of Google Inc.

TIDAL and TIDAL logo are registered trademark of Aspiro AB in the European Union and other countries.

© Copyright Cambridge Audio Ltd 2020.

Make sure you register your CA product:

[WWW.CAMBRIDGEAUDIO.COM/REGISTER](http://WWW.CAMBRIDGEAUDIO.COM/REGISTER)

For upcoming news on future products, software updates and exclusive offers.

## Support

If you have questions about your Cambridge Audio product visit

<https://support.cambridgeaudio.com> where you will find FAQs and guides to assist you.

# Important safety instructions

For your own safety please read the following important safety instructions carefully before attempting to connect this unit to the mains power supply. They will also enable you to get the best performance from and prolong the life of the unit:

1. Read these instructions.
2. Keep these instructions.
3. Heed all warnings.
4. Follow all instructions.
5. Do not use this apparatus near water.
6. Clean only with a dry cloth.
7. Do not block any ventilation openings. Install in accordance with the manufacturer's instructions.
8. Do not install near any heat sources such as radiators, heat registers, stoves, or other apparatus (including amplifiers) that produce heat.
9. Do not defeat the safety purpose of the polarized or grounding-type plug. A polarized plug has two blades with one wider than the other. A grounding-type plug has two blades and a third grounding prong. The wide blade or the third prong are provided for your safety. If the provided plug does not fit into your outlet, consult an electrician for replacement of the obsolete outlet.
10. Protect the power cord from being walked on or pinched, particularly at plugs, convenience receptacles and the point where they exit from the apparatus.
11. Only use attachments/accessories specified by the manufacturer.
12. Use with only the cart, stand, tripod, bracket, or table specified by the manufacturer, or sold with the apparatus.  When a cart is used, use caution when moving the cart/apparatus combination to avoid injury from tip-over.
13. Unplug this apparatus during lightning storms or when unused for long periods of time.
14. Refer all servicing to qualified service personnel. Servicing is required when the apparatus has been damaged in any way, such as the power-supply cord or plug having been damaged, liquid has been spilled or objects have fallen into the apparatus, the apparatus has been exposed to rain or moisture, does not operate normally, or has been dropped.

## WARNING:

- Do not place the unit in an enclosed space; if you wish to place the unit on a shelf, use the top shelf to allow maximum ventilation. Do not put any objects on top of this unit. Do not situate it on a rug or other soft surface and do not obstruct any air inlets or outlet grilles. Do not cover the ventilation grilles with items such as newspapers, tablecloths, curtains, etc.
- To reduce the risk of fire or electric shock, do not expose this apparatus to rain or moisture. This unit must not be used near water or exposed to dripping or splashing water or other liquids. No objects filled with liquid, such as vases, shall be placed on the unit.
- Danger of explosion if battery is incorrectly replaced. Replace only with the same or equivalent type.
- The battery (battery pack or batteries installed) shall not be exposed to excessive heat such as sunshine, fire or the like.
- The unit must be installed in a manner that makes disconnection of the mains plug from the mains socket outlet (or appliance connector from the rear of the unit) possible. Where the mains plug is used as the disconnect device, the disconnect device shall remain readily operable.
- Please refer to the information on the exterior rear panel for electrical and safety information before installing or operating the apparatus.
- Only use the mains cord supplied with this unit.

Use of the apparatus in tropical climates - The equipment shall be used at a maximum 45 degree C ambient temperature.

The unit is of Class 1 construction and must be connected to a mains socket outlet with a protective earthing connection.



The lightning flash with the arrowhead symbol within an equilateral triangle is intended to alert the user to the presence of un-insulated 'dangerous voltage' within the product's enclosure that may be of sufficient magnitude to constitute a risk of electric shock to persons. Warning: To reduce the risk of electric shock, do not remove cover (or back) as there are no user-serviceable parts inside. Refer servicing to qualified personnel. The exclamation point within an equilateral triangle is intended to alert the user to the presence of important operating and maintenance instructions in the service literature relevant to this appliance

## VENTILATION

Important! The unit will become hot when in use. Do not stack multiple units on top of each other.

Ensure that small objects do not fall through any ventilation grille. If this happens, switch off immediately, disconnect from the mains supply and contact your dealer for advice.

## POSITIONING

Choose the installation location carefully. Avoid placing it in direct sunlight or close to a source of heat. No naked flame sources, such as lighted candles, should be placed on the unit. Also avoid locations subject to vibration and excessive dust, cold or moisture. The unit can be used in a moderate climate.

This unit must be installed on a sturdy, level surface. Do not place in a sealed area such as a bookcase or in a cabinet. Do not place the unit on an unstable surface or shelf. The unit may fall, causing serious injury to a child or adult as well as serious damage to the product. Do not place other equipment on top of the unit.

Due to stray magnetic fields, turntables or CRT TVs should not be located nearby due to possible interference. Electronic audio components have a running in period of around a week (if used several hours per day). This will allow the new components to settle down and the sonic properties will improve over this time

## POWER SOURCES

The unit should be operated only from the type of power source indicated on the marking label. If you are not sure of the type of power-supply to your home, consult your product dealer or local power company. If you do not intend to use this unit for a long period of time, unplug it from the mains socket.

## OVERLOADING

Do not overload wall outlets or extension cords as this can result in a risk of fire or electric shock. Overloaded AC outlets, extension cords, frayed power cords, damaged or cracked wire insulation and broken plugs are dangerous. They may result in a shock or fire hazard.

Be sure to insert each power cord securely. To prevent hum and noise, do not bundle the interconnect leads with the power cord or speaker leads.

## CLEANING

To clean the unit, wipe its case with a dry, lint-free cloth. Do not use any cleaning fluids containing alcohol, ammonia or abrasives. Do not spray an aerosol at or near the unit.

## SERVICING

These units are not user serviceable. Never attempt to repair, disassemble or reconstruct the unit if there seems to be a problem. A serious electric shock could result if this precautionary measure is ignored. In the event of a problem or failure, please contact your dealer.

# Wi-Fi information

## BATTERY DISPOSAL

Batteries may contain substances harmful to the environment. Please dispose of any discharged batteries with due consideration and in accordance with local environmental/electronic recycling guidelines.



## WEEE SYMBOL

The crossed-out wheeled bin is the European Union symbol for indicating separate collection for electrical and electronic equipment. This product contains electrical and electronic equipment which should be reused, recycled or recovered and should not be disposed of with unsorted regular waste. Please return the unit or contact the authorised dealer from whom you purchased this product for more information.



## CE MARK

This product complies with European Low Voltage (2014/35/EU), Electromagnetic Compatibility (2014/30/EU) and Environmentally-friendly design of Energy-related Products (2009/125/EC) Directives when used and installed according to this instruction manual. For continued compliance only Cambridge Audio accessories should be used with this product and servicing must be referred to qualified service personnel.



## RCM (REGULATORY COMPLIANCE MARK)

This product meets Australia, New Zealand Safety, EMC and Radio Communications requirements of the ERAC and ACMA.

## FEDERAL COMMUNICATIONS COMMISSION

Supplier's declaration of conformity (SDoC)

Equipment(s): All In One Player

Model(s): Evo 75, Evo 150

Trademark: Cambridge Audio

This device complies with Part 15 of the FCC Rules. Operation is subject to the following two conditions: (1) this device may not cause harmful interference, and (2) this device must accept any interference received, including interference that may cause undesired operation.

The responsible party in US:

Company name: Audio Partnership LLC

Address: 1913 N Milwaukee Ave. Chicago, IL 60647

Phone: (312) 636-4817

Legal Representative Person: Gregg Chopper

Signature:

## FEDERAL COMMUNICATIONS COMMISSION NOTICE:

This equipment has been tested and found to comply with the limits for a Class B digital device, pursuant to Part 15 of the FCC Rules. These limits are designed to provide reasonable protection against harmful interference in a residential installation.

This equipment generates, uses, and can radiate radio frequency energy, and if not installed and used in accordance with the instructions, may cause harmful interference to radio communications. However, there is no guarantee that interference will not occur in a particular installation.

If this equipment does cause harmful interference to radio or television reception, which can be determined by turning the equipment off and on, the user is encouraged to try and correct the interference by one or more of the following measures:

- Reorient or relocate the receiving antenna.
- Increase the distance between the equipment and the receiver.
- Connect the equipment to an outlet on a circuit different from that to which the receiver is connected.
- Consult the dealer or an experienced radio/TV technician for help.

FCC Caution: Any changes or modifications not expressly approved by the party responsible for compliance could void the user's authority to operate this equipment.

2.4 GHz Wi-Fi operation of this product in the USA is hardware limited to channels 1 through 11.

5G channels are 36-48, 52-64, 100-140, 149-161.

## FCC RADIATION EXPOSURE STATEMENT:

This equipment complies with FCC radiation exposure limits set forth for an uncontrolled environment. This equipment should be installed and operated with a minimum distance of 20cm between the radiator and your body.

This transmitter must not be co-located or operating in conjunction with any other antenna or transmitter.

## MODIFICATIONS:

The FCC requires the user to be notified that any changes or modifications to this device that are not expressly approved by Cambridge Audio, may void the user's authority to operate the equipment.

# Limited warranty

## CANADA - INDUSTRY CANADA (IC)

This radio transmitter has been approved by Industry Canada.

This device complies with Industry Canada License exempt RSS standard(s). Operation is subject to the following two conditions.

(1) this device may not cause interference and (2) this device must accept any interference, including interference that may cause undesired operation of the device. This equipment should be installed and operated with a minimum distance of 20cm between the radiator and your body.

The transmitter must not be co-located or operating in conjunction with any other antenna or transmitter.

## INDUSTRIE CANADA (IC)

Le présent appareil est conforme aux CNR d'Industrie Canada applicables aux appareils radio exempts de licence. L'exploitation est autorisée aux deux conditions suivantes :

(1) l'appareil ne doit pas produire de brouillage, et (2) l'utilisateur de l'appareil doit accepter tout brouillage radioélectrique subi, même si le brouillage est susceptible d'en compromettre le fonctionnement. Cet équipement doit être installé et utilisé à une distance minimale de 20 cm entre le radiateur et votre corps.

L'émetteur ne doit pas être co-placé ni fonctionner en conjonction avec une autre antenne ou transmetteur.

## EUROPE-EUROPEAN UNION NOTICE

Hereby, Audio Partnership PLC declares that this product is in compliance with Directive 2014/53/EU, the full text of the EU declaration of conformity is available at the following internet address: <https://www.cambridgeaudio.com/DoC>

WARNING: To reduce exposure to electromagnetic radiation, it is advised that user is situated at least 20cm from the Wi-Fi Antenna during normal operation.

FCC ID:YKBCA0999-038 IC:9095A-CA0999038

CAN ICES-3 (B)/NMB-3 (B)

Contains FCC ID:UAY-W8997-M1216 IC:6549A-W8997M1216

**Bluetooth** Radio frequency: 2.402GHz-2.48GHz, Max. transmit power: 10dBm.

### EUROPE STANDARD:

**Wi-Fi 2.4G** Radio frequency: 2412-2472MHz, the Max. EIRP power 23dBm

**Wi-Fi 5G** Radio frequency: 5180-5825MHz, the Max. EIRP power 26dBm

Cambridge Audio warrants this product to be free from defects in materials and workmanship (subject to the terms set forth below). Cambridge Audio will repair or replace (at Cambridge Audio's option) this product or any defective parts in this product. Warranty periods may vary from country to country. If in doubt consult your dealer and ensure that you retain proof of purchase.

To obtain warranty service, please contact the Cambridge Audio authorised dealer from which you purchased this product. If your dealer is not equipped to perform the repair of your Cambridge Audio product, it can be returned by your dealer to Cambridge Audio or an authorised Cambridge Audio service agent. You will need to ship this product in either its original packaging or packaging affording an equal degree of protection.

Proof of purchase in the form of a bill of sale or receipted invoice, which is evidence that this product is within the warranty period, must be presented to obtain warranty service.

This Warranty is invalid if (a) the factory-applied serial number has been altered or removed from this product or (b) this product was not purchased from a Cambridge Audio authorised dealer. You may call Cambridge Audio or your local country Cambridge Audio distributor to confirm that you have an unaltered serial number and/or you made a purchase from a Cambridge Audio authorised dealer.

This Warranty does not cover cosmetic damage or damage due to acts of God, accident, misuse, abuse, negligence, commercial use, or modification of, or to any part of, the product. This Warranty does not cover damage due to improper operation, maintenance or installation, or attempted repair by anyone other than Cambridge Audio or a Cambridge Audio dealer, or authorised service agent which is authorised to do Cambridge Audio warranty work. Any unauthorised repairs will void this Warranty. This Warranty does not cover products sold AS IS or WITH ALL FAULTS.

REPAIRS OR REPLACEMENTS AS PROVIDED UNDER THIS WARRANTY ARE THE EXCLUSIVE REMEDY OF THE CONSUMER. CAMBRIDGE AUDIO SHALL NOT BE LIABLE FOR ANY INCIDENTAL OR CONSEQUENTIAL DAMAGES FOR BREACH OF ANY EXPRESS OR IMPLIED WARRANTY IN THIS PRODUCT. EXCEPT TO THE EXTENT PROHIBITED BY LAW, THIS WARRANTY IS EXCLUSIVE AND IN LIEU OF ALL OTHER EXPRESS AND IMPLIED WARRANTIES WHATSOEVER INCLUDING, BUT NOT LIMITED TO, THE WARRANTY OF MERCHANTABILITY AND FITNESS FOR A PRACTICAL PURPOSE.

Some countries and US states do not allow the exclusion or limitation of incidental or consequential damages or implied warranties so the above exclusions may not apply to you. This Warranty gives you specific legal rights, and you may have other statutory rights, which vary from state to state or country to country.

For any service, in or out of warranty, please contact your dealer.

# Rear panel connections

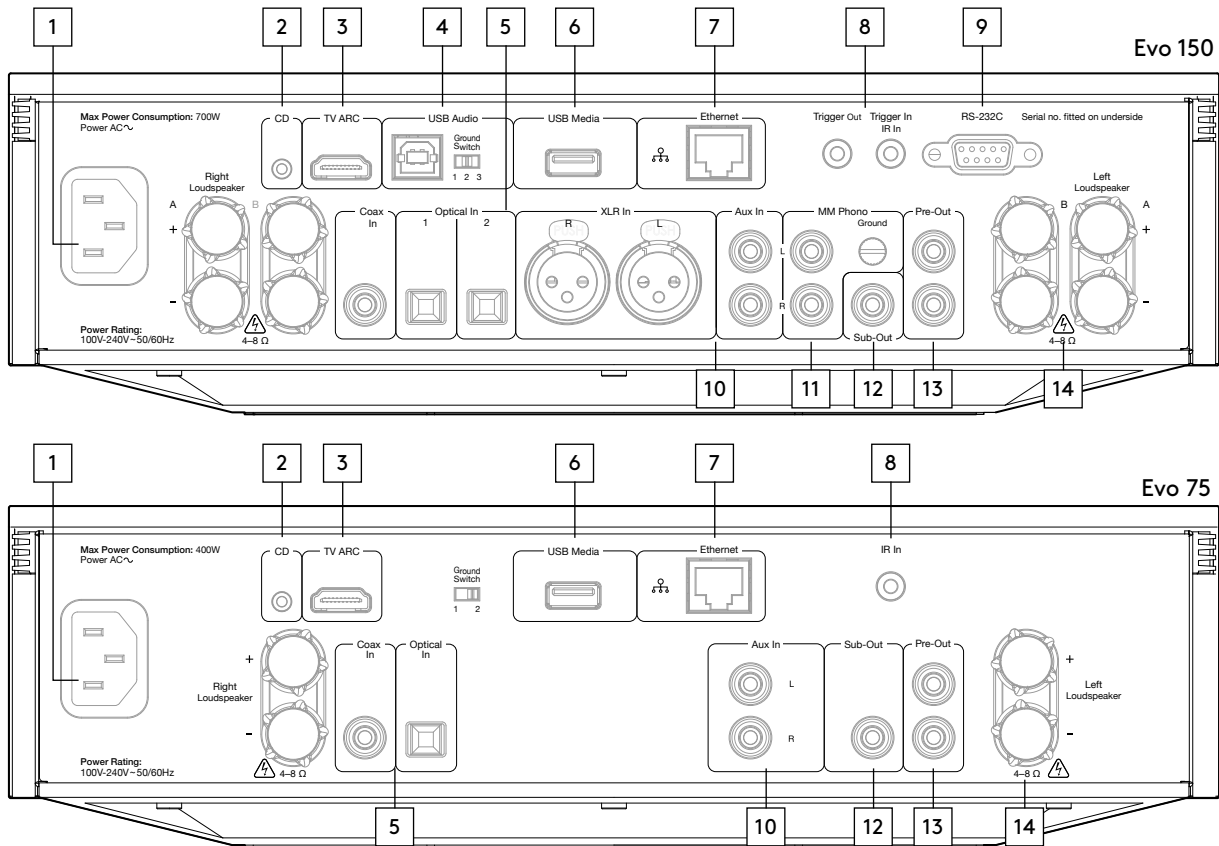

## 1. AC POWER SOCKET

## 2. CD

allows for Evo CD using this control system and display from your Evo 75/ Evo 150

## 3. AUDIO RETURN CHANNEL (ARC)

Connection from a TV that supports ARC function

## 4. USB AUDIO IN (EVO 150 ONLY)

For connecting to PC/MAC computers. (Class 2 USB Audio only. windows based PC's require a Cambridge Audio USB drive to be installed before connection)

### GROUND SWITCH

- 1: The Ground Switch enables the USB interface earth and main board earth to be disconnected from the Evo 75/Evo 150 chassis earth.
- 2: Disconnecting (**lifting**) the earth can be useful if electronic hum is heard through the speakers. the switch should otherwise be left in the Ground position.
- 3: The Ground Switch enables the USB interface earth and main board earth connected from the Evo 150 chassis earth. (Evo 150 only)

## 5. DIGITAL INPUTS (COAX IN, OPTICAL IN1/IN2)

Note: Optical in 2 is available on the Evo 150 only.

## 6. USB MEDIA

For connecting local media storage. Note that the USB ports are not intended for connection to Apple mobile devices; no functionality, charging or otherwise is supported.

## 7. ETHERNET

Ethernet port for connecting to a 10/100BASE-T local area network (LAN). Your unit will automatically default to an Ethernet connection if one is made.

## 8. TRIGGER IN/OUT (EVO 150 ONLY)

The Evo 150 can be connected to the trigger control output of home

automation equipment to control the power state of the Evo 150. The input level should be 12V. The trigger out will go high while the Evo 150 is powered on. This can be used to turn on other equipment that has a trigger in.

**IR In:** Allows modulated IR commands from an IR repeater or custom install systems to be received by the amplifier.

## 9. RS232C

Custom install control - a full protocol is available for the Evo 150 on our website.

## 10. ANALOGUE INPUTS (XRL IN, AUX IN)

Note: Blanced (XLR in) is available on the Evo 150 only.

the balanced connection is the higher quality option and can reject noise and interference in the cable when used with other equipment that supports this function. An XLR connector is wired Pin 1 - Ground; Pin 2 - Hot (in-phase); Pin 3 - Cold (phase-inverted).

Aux in is suitable for any 'line level' source equipment such as CD players, DAB or FM/AM tuners etc.

Note: These inputs are for analogue audio signals only. They should not be connected to the digital output of a CD player or any other digital device.

## 11. MM PHONO INPUT (EVO 150 ONLY)

This input has a built in phono stage. Record players fitted with Phono Cartridges of the Moving Magnet (MM), the "ground" terminals on both the recorder player and the Evo 150 should be connected (where possible) with a ground wire for lowest noise/hum pickup.

## 12. SUB OUT

Connect to the input on an active subwoofer if required.

## 13. PRE-OUT

For connection to the unbalanced inputs of a power amplifier or active subwoofer.

## 14. LOUDSPEAKER TERMINALS

**Important Note:** When using a banana plug, make sure the speaker terminals are completely tightened before inserting the plug.

**B SPEAKER (Evo 150 ONLY)**

# Front panel controls

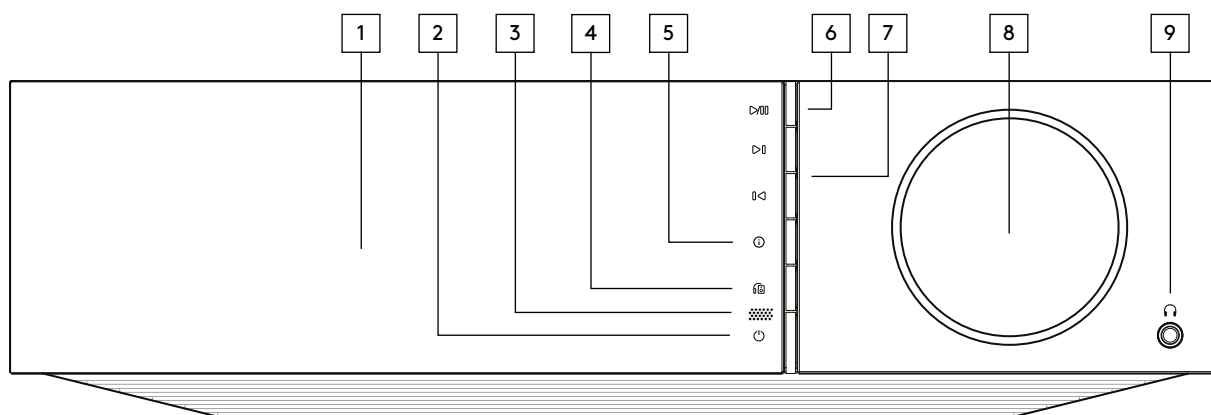

## 1. DISPLAY

## 2. STANDBY/ON

## 3. INFRARED SENSOR

Receive IR commands from the supplied remote control. A clear unobstructed line of sight between the remote control and the sensor is required.

## 4. ENTER

## 5. RETURN

Press to return to the previous menu.

## 6. PLAY/PAUSE

Plays and pauses playback

## 7. SKIP

Press once to skip forwards or backwards one track.

## 8. VOLUME/SOURCE SELECTOR

To change the volume, rotate the front part.

To select a source, rotate the back part.

### FAST SCROLL FEATURE

When scrolling through lists of tracks or stations, normally rotating the the front part of the source selector

## 9. HEADPHONES

For suitable headphones – connection will automatically mute the pre-out.

# Remote control

## 1. STANDBY/ON

## 2. MUTE

## 3. PRESETS

Press to directly access stored presets.

## 4. ENTER

Press to accept the item/function highlighted in the display menu. In tuner mode, press and hold to store the current station in the preset bank.

## 5. BRIGHTNESS

Alters the brightness of the Evo 75/Evo 150 display backlight. There are three brightness levels; off, dim, bright and an option to switch-off the backlight.

When the display is set to OFF, nothing will be displayed onscreen until a selection is made via the front panel or remote control. The display will then re-activate allowing you to browse the menu and make your selection. The display will then automatically switch back off after a few seconds if no further selections are made.

## 6. RETURN

Press to return to the previous menu.

## 7. OPEN/CLOSE

Opens and closes the disc tray of Evo CD

## 8. STOP/9 PLAY/PAUSE/SKIP

Press the relevant button to play, pause or stop the track.

Right Skip - Press to skip forward.

Left Skip - Press to skip backward.

## 10. SOURCE

Press to select the digital input source.

## 11. VOLUME

Increases or decreases the volume.

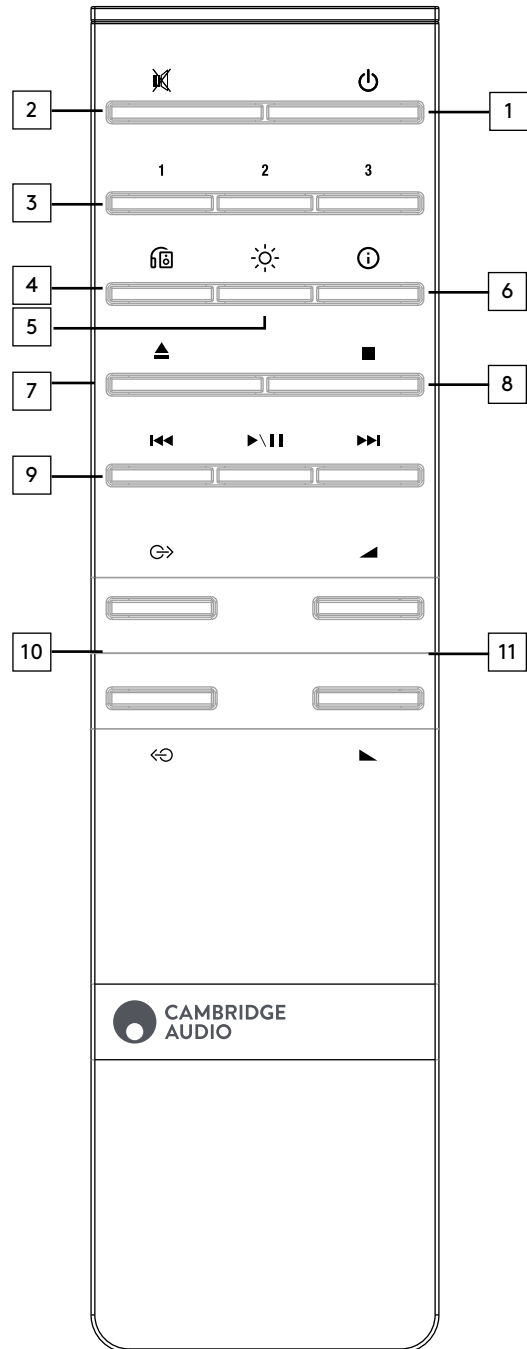

# Replaceable side panelling

The Evo 75/Evo 150 with wood effect side panelling design, it's easy to match your Evo to your living environment. You can choose a new finish from our contemporary range of customised side panels

when installing new magnetic side panels, please ensure their rabbets are aligned with the direction of the front panel.

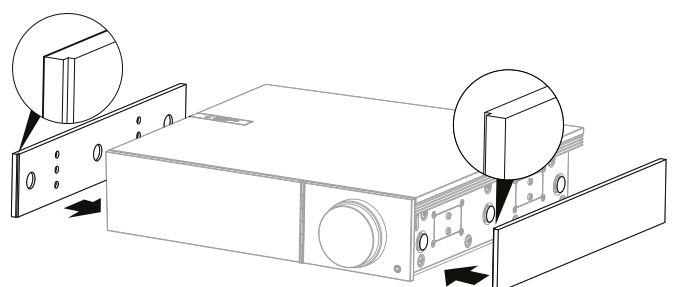



## Overview

The Evo 75/Evo 150 are able to receive and play back media from several distinct types of source. Here we have attempted to give an overview of the various types of service available and the terminology you may encounter.

### INTERNET RADIO

These are 'radio' stations broadcast over the internet. Currently the StreamMagic range can access about 20,000 internet radio stations all sorted by us into Location, Language and Genre. The list of available stations is constantly maintained and automatically updated to your unit via the internet. You can set your own presets via the Cambridge Connect app or the front panel of the player.

You can also add stations to your units that are currently not in the Stream Magic's Radio database, suggest new stations to us and more. There are also links and help for setting up third-party Streaming Services from a wide variety of other suppliers. Other Stream Magic features will be launched in the future, check the website from time to time to see the latest developments.

### STREAMING SERVICES

Streaming Services are similar to Internet Radio but come from other suppliers and often have an element of interaction with the user. Because Streaming Services generally allow the user some choice over the content they listen to, they are also licensed differently to Internet Radio by the music companies and often each service only has arrangements in certain countries and may also charge a subscription for membership.

Examples of such services are Spotify, Pandora, TIDAL and others. All allow some control of the content from the ability to select and play whole albums of your choice, playlists or an artists back catalogue. Some also offer the ability to download content for use off-line as well.

These services come from third parties and although we support connections to them via our Connect app or the units' webmin page; we do not create their content and are not responsible for their service in any way. Your streaming account is with the streaming service only. We are merely acting as an intermediary to make the connection simpler and more convenient. We will support the correct software on our unit to allow playback and browsing of their content.

### NETWORK MEDIA

The Evo 75/Evo 150 support a wide range of compressed formats; MP3, AAC, WMA and Ogg Vorbis CODEC types are all supported, plus for true audiophile use it also supports either uncompressed PCM (in a WAV container) or losslessly compressed FLAC, both can contain from 16-bits/44.1kHz from CDs right up to 24-bit/192kHz for better than CD quality from suitable download sites.

**Note:** For this to work your server will also need to support the CODEC you wish to play as some have limitations and may not serve FLAC for instance. Always check that the server you wish to use also supports your favoured CODECs.

Also for lossless/uncompressed formats both the server and network connection will need to sustain the high bitrate necessary.

**Note:** It is not recommended to use Wi-Fi connections for content above 24bits, 96kHz if lossless/uncompressed.

### USB MEDIA

The Evo 75/Evo 150 also support USB Media from USB Flash-disks or USB hard-drives and has 3 USB 2.0 ports for this purpose. Here the Evo 75/Evo 150 simply browse the folders present on the media attached and displays them. Only content that the Evo 75/Evo 150 can play will be shown. This feature is provided for convenient access to temporary storage devices.

It is however highly recommended that UPnP is used for continued use of stored media as the UPnP system is able to support album art, sophisticated content browsing and filtering and other features not possible with simple folder browsing.

**Note:** Supports NTFS and FAT32 file system.

### PODCASTS

Podcasts are archived audio recordings downloadable over the internet. Often podcasts are recordings of previous live broadcasts or episodic content.

The Evo 75/Evo 150 support various third party podcast services, navigate to Podcasts on the unit for the list available in your area. In addition the Evo 75/Evo 150 support your own personal choice of podcasts where you know its URL (weblink) via the Webmin page.

## Getting connected

When designing our Evo 75/Evo 150 we include features that allow you to connect your system in various ways. The inclusion of features such as Pre-Out and Speaker B connections mean that you can flexibly configure your system depending on your requirements.

**Important Note:** When using a banana plug, make sure the speaker terminals are completely tightened before inserting the plug.

### BASIC CONNECTIONS

The diagram below shows the basic connection of your Evo 75/Evo 150 to a pair of loudspeakers.

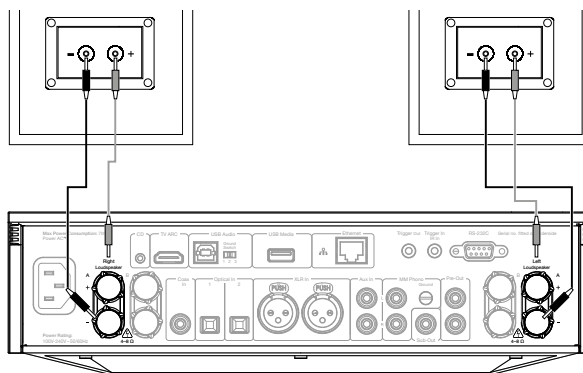

### SPEAKER B CONNECTIONS (EVO 150 ONLY)

The Speaker B connections on the back of the amplifier allow for a second set of speakers to be used (i.e. speakers located in another room). Go to "Settings-> Audio -> Speaker B -> set to On". scrolls through the selection of speaker A only, speaker B only, and speaker A and B together.

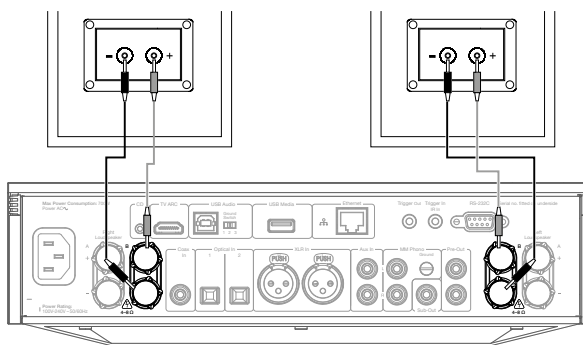

### PREAMP OUT CONNECTIONS

The Preamp Out sockets are for connecting to the input sockets of a power amplifier or active subwoofer. The diagram below shows how to connect the amplifier to an active subwoofer via the Line In inputs on the subwoofer.

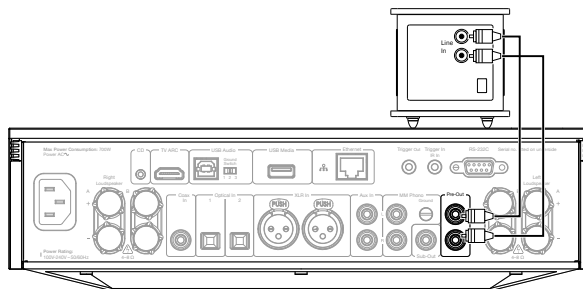

### BALANCED AUDIO CONNECTIONS (EVO 150 ONLY)

The diagram below shows how to connect the Evo 150 to the player using the Balanced Audio inputs via three pin XLR connectors. The Evo 150 can also be connected to non-Cambridge Audio sources with balanced outputs.

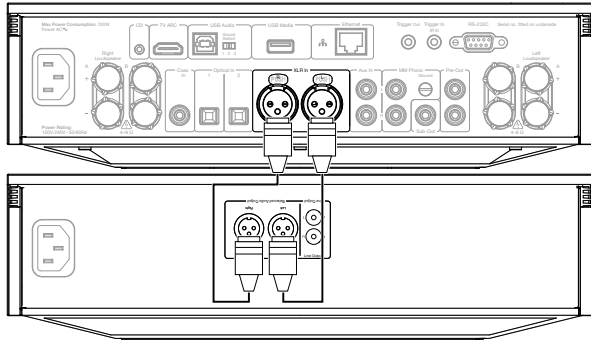

Balanced connections in an audio system are designed to reject electrical noise, from power wiring etc, and also the effects of noise currents flowing through ground connections. The basic principle of balanced interconnection is to get the signal you want by subtraction, using a three-wire connection. One signal wire (the hot or in-phase) carries the normal signal, while other (the cold or phase-inverted) carries an inverted version. The balanced input senses the difference between the two lines to give the wanted signal. Any noise voltages that appear identically on both lines (these are called common-mode signals) are cancelled by the subtraction.

The Evo 150 is designed to work at its highest performance when a balanced interconnect is used.

**Note:** To select the XLR in (balanced input) on the Evo 150, rotate the back part of the source selector.

### USB AUDIO CONNECTION (EVO 150 ONLY)

The Evo 150 USB input enable the playback of audio files or streamed programme from Microsoft Windows or Apple Mac OS X personal computers (and some Linux builds). When connected via USB the personal computer will identify the Evo 150 as an audio device. Specifying the Evo 150 in the computer's audio control panel will enable it to play audio data either stored locally on the computer or streamed to the computer via a network or the internet.

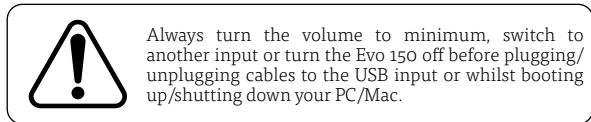
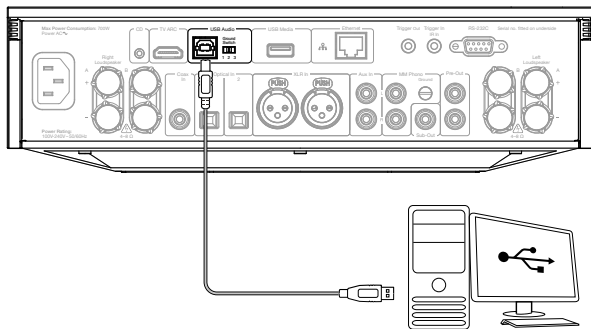

Always turn the volume to minimum, switch to another input or turn the Evo 150 off before plugging/unplugging cables to the USB input or whilst booting up/shutting down your PC/Mac.

**Note:** Always use a high quality USB connection cable certified as USB Hi-Speed. USB cable connections longer than 3m may result in inconsistent audio performance.

### ADVANCED USB AUDIO

The Evo 150 is both USB 2.0 (Hi-Speed) and USB 1.1 (Full-speed) USB port compatible.

It should also work with the new USB 3.0 ports where the PC will simply treat the Evo 150 as if it were a USB 2.0 or 1.1 device.

The Evo 150 supports two USB Audio protocols (not the same as the port types themselves) USB Audio Class 1 (which works over USB 1.1 ports and supports up to 24-bit/96kHz) or USB Audio Class 2 (which requires a USB 2.0 port and can support up to 32-bit/384kHz). (asynchronous) and up to DSD-256.

The default configuration is USB Audio Class 2.

See our online guide at [www.cambridgeaudio.com/USB-Audio](http://www.cambridgeaudio.com/USB-Audio) on USB Audio for more details. With careful choice of playback software and settings many pitfalls can be avoided.

Windows based PC's required a Cambridge Audio USB driver to be installed before connection.

USB mode can be selected in the Setup menu. See 'Setup' section.

A brief explanation of your choices are below:

#### USE WITH PCS

With the Evo 150 switched to USB Audio Class 1 the Evo 150 will work with the native Windows XP, Vista, 7, or 8 Audio 1.0 driver (no need to load any new driver) and accept audio up to 24-bit/96kHz.

With the Evo 150 switched to USB Audio Class 2 the Evo 150 needs the Cambridge Audio USB Audio 2.0 Driver to be loaded and can then accept up to 32-bit/384kHz.

The driver is available from [www.cambridgeaudio.com/USB-Audio](http://www.cambridgeaudio.com/USB-Audio)

#### USE WITH MACS

No extra drivers are required. With the Evo 150 switched to USB Audio 1.0 the Evo 150 will work with the native Mac OS-X 10.5 (Leopard) or above Audio 1.0 driver and accept audio up to 24-bit/96kHz.

With the Evo 150 switched to USB Audio Class 2 the Evo 150 works with the native Mac OS-X 10.5 (Leopard) or above Audio 2.0 driver and can accept audio up to 32-bit/384kHz.

#### USE WITH LINUX

For most builds of Linux with the Evo 150 switched to USB Audio Class 1 the Evo 150 will work with the native Audio 1.0 driver and accept audio up to 24-bit/96kHz.

Some very new builds of Linux are now supporting USB Audio Class 2 for which the Evo 150 should be switched to Audio 2.0 to accept audio up to 32-bit/384kHz.

For both cases because Linux builds vary according to their creators choice of software components including drivers it is not possible to guarantee operation and Audio drivers may need to be loaded.

'Class drivers' as they are called for generic support of Audio Class 1.0 or Audio Class 2.0 devices may be available from the Linux community, we do not supply these.

# Getting connected

## NETWORK CONNECTIONS

Before you can use your Evo 75/Evo 150 for Radio/Streaming you must have the following:

- A broadband internet connection (such as ADSL) to a suitable internet service provider (ISP).
- A network connection either wirelessly via 802.11b/g/n or ac Wi-Fi or wired Ethernet connection (10 or 100 M bits/sec via an RJ45 connection).

**Note:** For playback of high sample rate files (24-bits/176.4kHz & 24-bits/192kHz) streamed from your home network, we recommend using an Ethernet connection to avoid unwanted disruption as the high data rate of these files is beyond most Wi-Fi networks capability.

In many cases the broadband modem, router and wireless access point will be a single combined unit supplied by your Internet Service Provider or bought from a computer store.

If your wireless network is configured to use Wired Equivalent Privacy (WEP) or Wi-Fi Protected Access (WPA) data encryption then you will need to know your WEP or WPA key so you can get the Evo 75/Evo 150 to communicate with the network.

### IMPORTANT:

**Before you continue, make sure that your wireless access point or router is powered up and working with your broadband internet service (use your computer to verify this). To get this part of the system working you must read the instructions supplied with the wireless access point or router.**

The Evo 75/Evo 150 can be configured to connect to a Wired or Wireless network or has an (default) Auto setting. In Auto the Evo 75/Evo 150 looks for a each connection type and selects whichever is present. You can also force the unit to one or the other connection type, see later Settings section.

Place the Evo 75/Evo 150 in range of your wireless network (usually 10-30m of a suitable wireless transmitter, although this is affected by walls and the construction of your building) and turn it on, via the back panel switch and then on the front panel.

The Evo 75/Evo 150 will automatically connect and obtain an IP address from your wireless network. For advanced users, if you would like to give your Evo 75/Evo 150 a static IP address, then see the 'Network config' section of the manual.

**Note:** If you make a mistake at any point, you can always press the **i** button to go back to the previous screen.

The unit will now scan for all available wireless networks and will display "Scanning".

If it can't find one then the display will say: "No Wireless Networks Found". If this happens then you need to either move the Evo 75/Evo 150 nearer your wireless access point or investigate any issues with your wireless network.

When the Evo 75/Evo 150 find your wireless network, it displays the broadcast name (ESSID) for the access point – this is a name allocated to the access point by whoever set up the network, it may either be a default name for your router/wireless or may be a more familiar name such as "Johns Wi-Fi" etc. If your Evo 75/Evo 150 find more than one wireless network you can simply choose which one you want to connect to. Turn the rotary dial to see the ESSID for each wireless network.

When the ESSID for the wireless network you want to connect to is displayed on the screen, press the SELECT button. If your network is not configured with an encryption code, the screen should say "Connecting to network" then "Network OK".

If the screen displays either "Enter WEP key" or "Enter WPA key", then the network is using one of the supported encryption systems: Wired Equivalent Privacy (WEP) or Wi-Fi Protected Access (WPA). You now need to enter your correct WEP or WPA code. The person who set up the wireless network in the first place will know what this code is (or be able to reset it to a new known code); if that person is not you, then you need to find out what it is.

After 3 seconds, the display goes into the code entry mode. To enter the code, use the rotary dial to select each character of the code in turn, pressing the SELECT button after entering each character.

**Note:** The WEP and WPA codes are case sensitive, so you must enter them exactly.

After entering the final character, use the front part of rotary dial to select the **↩** character and press the **i** button. It's a little fiddly but you will only need to do this once. The Evo 75/Evo 150 will remember this code and use it automatically from now on.

The unit should now be able to connect to the network.

**Note: We recommend rebooting your Evo 75/Evo 150 to search for any firmware updates, as new firmware may have been released since your unit was manufactured.**

## CONNECTING TO A WIRED NETWORK

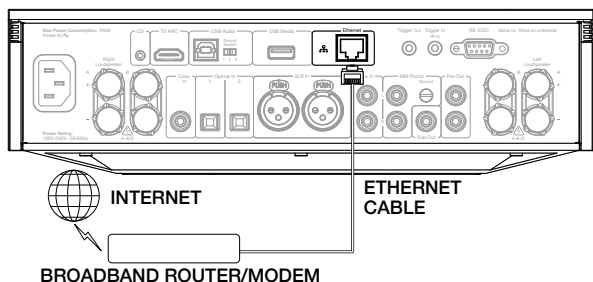

Plug one end of a network cable (Category 5/5E straight through Ethernet cable) into the LAN port on the back of the unit.

**Note:** Only connect the LAN port of the player to an Ethernet port that supports 10BASE-T or 100BASE-TX. Connecting to any other ports or jacks, such as a phone jack, can damage the unit

The Evo 75/Evo 150 should automatically connect to your network as below via DHCP; this means it will be given an IP address by your router automatically.

## CONNECTING TO A WIRELESS NETWORK

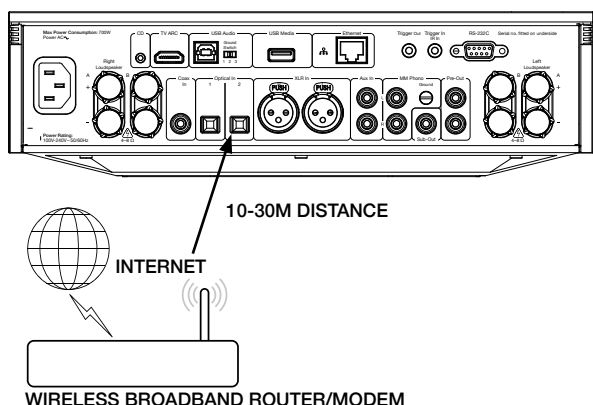

# Operating instructions

The Evo 75/Evo 150 home menu consist of 5 items:

## Presets Radio Music Library Inputs Settings

These allow access to the four basic types of media choice plus a Settings menu for the unit.

You can return to this menu at any time by pressing the  button.

Simply scroll through the items with the front part of scroll wheel and press in the  button or use the Enter button on the remote to select the item you want.

### PRESETS

The Evo 75/Evo 150 support presets. These can be Internet Radio stations or streams from most Streaming Services. UPnP/USB Media cannot be set as a preset. To add a station/stream to a preset, first select that stream for playback in the normal way. Now press the 'Home' button on the remote and navigate to the Presets menu.

Note: Empty presets are not displayed. To save a presets to an empty location, select 'Set Preset' and all slots will be displayed.

Select the preset location you require and press the Navigation/Select dial or the Enter button on the remote to save the current station/stream to that preset.

Recalling presets is done simply by selecting the Presets button on the remote or via the Home menu.

#### Note:

- The Evo 75/Evo 150 load the presets for display from our Stream Magic servers over the internet, thus they can take a few seconds to appear.
- All saved Presets will be deleted when a unit is registered/re-registered online.

### RADIO

The Stream Magic Internet Radio service brings thousands of internet radio stations to you. The sheer choice available on the internet allows you to find new music, listen to stations in your native language (or perhaps if you are learning another one), from your home town or by your Genre of choice.

It has to be said that the audio quality of internet radio varies greatly dependant on the bitrate and compression technology used by the broadcaster, but the choice more than makes up for this. Internet Radio allows you to explore and find new music from all over the world.

**Note:** As an 'aggregator' service we are simply organising the browsing and connection process for these stations so that you don't have to manually search for them or type in any URLs (web links) etc to access them. Whilst we regularly check the stations to make sure they are still transmitting reliably and in reasonable quality, we are not responsible for their content in any way.

If there is a station you would like added to the list that isn't currently available, please email us at [support@cambridgeaudio.com](mailto:support@cambridgeaudio.com) and we will be more than happy to look into the availability of this.

#### HOW TO USE RADIO

Press the  button to return to the top-level menu.

Select Radio from the list using the rotary dial then press the  button to select it. The Evo 75/Evo 150 display the following submenus.

#### RADIO

- » Location
- » Genre
- » Search Radio Stations

You can now turn the rotary dial to choose from Location, Genre, Search Radio Stations, Streaming Services or Podcasts.

**Location** – Enables you to choose from the stations in any of the countries which you choose from a list.

**Genre** – Enables you to choose radio stations according to their declared content, for example Classic Rock, Sport, News, etc.

**Search Radio Stations** – Enables you to search for a station you know the name of. Enter the full name or first part of the name for your desired station. The Evo 75/Evo 150 will bring up a list of all stations that contain a word that starts with your search term.

**Note:** Although we check the stations for continuity of service, some radio stations do not broadcast 24 hours per day, and some stations may not always be on-line.

### MUSIC LIBRARY

The Evo 75/Evo 150 can access media from UPnP/DNLA Servers or USB Media connected via USB. The Evo 75/Evo 150 display the following submenus:

UPnP is by far the preferred method as it allows for browsing by artist, album and other methods, has support for control from Wi-Fi controller and the media can be shared amongst several devices.

#### UPNP SERVERS

Your Evo 75/Evo 150 can connect with Computers or Network Attached Storage devices that feature a Universal Plug and Play (UPnP) AV Server.

When using a UPnP server to share your media, the search and selection criteria are determined by the server and not the Evo 75/Evo 150, but typically include Album, Artist and additional options such as Genre.

As long as the Evo 75/Evo 150 is correctly configured for your Network, it will automatically discover and connect to UPnP servers it finds. It will then allow navigation of the menu structure coming from that server.

There are many suitable UPnP server software packages available for PC and Mac. Stand-alone servers and Network Attached Storage (NAS) devices with built in UPnP server capabilities are also available. Please see the set-up guides on our website at <https://techsupport.cambridgeaudio.com/>.

Once you have setup a suitable server, navigate to the My Library menu and press Select.

The Evo 75/Evo 150 will perform a scan of your network and report any UPnP Servers it finds. If none are found it will display "No Servers Found" on the display. If a server or servers are found, UPnP server names will be displayed and you can select which one you'd like to get the contents from.

Select the server you want and the Evo 75/Evo 150 will then load the appropriate menu structure from that sever. These typically allows you to browse the content by Album, Artist, Genre etc. It is important to understand that the menu structure here is coming from the Server and not the Evo 75/Evo 150.



You can now browse and select any music content in a format the Evo 75/Evo 150 support (currently AAC, MP3, WMA, AIF, FLAC, WAV and Ogg Vorbis).

**Note:** Not all servers support serving of all these formats. Always make sure the server you choose also supports your formats of choice. For example, Windows Media Server does not currently serve FLAC format.

#### ALPHANUMERIC SEARCH

This is a search function menu inserted by the Evo 75/Evo 150 into the browse tree of UPnP servers that support an external search function.

Where available you can select Alphanumeric search and then enter the name or partial name of an album or track you wish to find.

Simply select each character in order using the Navigation/Select dial or the **navigation** buttons on the remote, using the dial, rotate to each character and then press in to select or press the Enter button on the remote. You can also use the  button to enter a character and the  button to delete a character.

Once finished either press the  button or navigate to the  symbol and press the Enter button on the remote

The Evo 75/Evo 150 then display all Album names or Track names it can find that matches your chosen text.

You can then simply select your chosen item and press the Enter or  button on the remote to start it playing.

#### THE 'NOW PLAYING' SCREEN

Selecting a new Station, Stream or Media item will start playback and display the 'Now Playing' screen.

The current Artist/Album and Track or Station name will be shown with the relevant CODEC details (i.e. audio file type and bitrate/sample rate.)

For Media files, the Evo 75/Evo 150 also shows the incremental track playback time.

You can also display the now playing screen at any time by pressing the  button on the remote control or front panel.

#### RANDOM

Accessed via the remote or the Cambridge Connect app only. Press the Random button to toggle Random On or Off.

The Evo 75/Evo 150 display a  in the 'Now Playing' screen when Random is On.

If the currently selected media item/folder contains fewer than 1000

tracks the Evo 75/Evo 150 generate a true random shuffle of those tracks and starts playback such that all are played once in a random order and then playback stops.

If more than 1000 tracks are contained the Evo 75/Evo 150 will instead pick a track at random for playback then pick another one randomly (and without reference to what has gone before) once the current one has finished.

This continues until Random is turned Off. Thus for >1000 tracks the playback of any track may be repeated randomly.

#### REPEAT

Accessed via the remote or the StreamMagic app only. Press the Repeat button to toggle Repeat On or Off.

If the currently selected media item is a track the Evo 75/Evo 150 will repeat that track, if it is an album or artist etc. the Evo 75/Evo 150 will repeat all tracks in that item.

The Evo 75/Evo 150 display a  in the 'Now Playing' screen when Repeat is On.

#### USB MEDIA

The Evo 75/Evo 150 can also playback audio content from standard USB hard-drives and thumb drives. Simply copy your media files onto your USB drive and then connect it to the front or back USB sockets of the unit.

Press the Home button to get to the top menu. Select the 'Music Library' menu.

The Evo 75/Evo 150 will now scan the thumb drive for media files. Once the scan is completed, you will then be able to browse the files by selecting 'By Album' or 'By Artist'.

#### QUEUE

##### Viewing the queue

To view the queue at any time press the '...' (more) button. You can jump playback to any point in the queue by navigating up/down the list and pressing the Enter button.

##### Editing the queue

Tracks can be removed from the queue by highlighting them with the navigator and pressing the Stop button.

To clear an entire queue, navigate to the bottom of the queue to highlight [Clear Queue] and press the Enter button.

Note: Switching the Evo 75/Evo 150 into standby will delete the queue.

#### PLAYLIST

The Evo 75/Evo 150 also support various playlist formats. For permanent storage of favourite media selections it is recommended to use suitable software to create playlist.

These can then be accessed by the Evo 75/Evo 150 from USB Media or UPnP servers that support Playlist serving.

## Inputs

- » XLR IN
- » A1/ PHONO/
- » D1-D3 (S/PDIF Coax/TOSLINK Optical)
- » ARC/ CD
- » USB Audio
- » Bluetooth
- » AirPlay
- » Roon read
- » Spotify

#### BLUETOOTH AUDIO STREAMING

Selecting this allows the Evo 75/Evo 150 to receive wireless Bluetooth audio from most phones/tablets and laptops.

#### PAIRING

To begin streaming high quality music from your chosen media source it will first need to be paired with the Evo 75/Evo 150.

Note: Your device can only be paired and connected to the Evo 75/Evo 150 while the Bluetooth source is selected.

#### SPOTIFY



Spotify lets you listen to millions of songs – the artists you love, the latest hits and discoveries just for you. If you are a Spotify Premium user, you can control your Evo 75/Evo 150 using the Spotify app.

1. Connect your Evo 75/Evo 150 to the same Wi-Fi network as your phone or tablet running the Spotify app.
2. Open the Spotify app, and play any song.
3. Tap the song image in the bottom left of the screen.
4. Tap the Connect icon .
5. Pick your Evo 75/Evo 150 from the list.

For information on how to set up and use Spotify Connect please visit [www.spotify.com/connect](http://www.spotify.com/connect).

The Spotify Software is subject to third party licenses found here: [www.spotify.com/connect/third-party-licenses](http://www.spotify.com/connect/third-party-licenses).

#### AIRPLAY

1. Connect your Evo 75/Evo 150 to your network.
2. Open the app that you want to AirPlay from.
3. Tap  or .
4. Select Evo 75/Evo 150 as your AirPlay device.

#### From Control Center

To switch the audio on your device from Control Center: Swipe up from the bottom edge of any screen on your device to open Control Center.

Touch and hold  in the upper-right corner, then select your Evo 75/Evo 150.

#### CHROMECAST BUILT-IN

Evo 75/Evo 150 comes with Chromecast built-in. It lets you stream your favorite music from your phone, tablet or laptop to your speaker.\*

\*Works with compatible iPhone®, iPad®, Android phone and tablet, Mac® and Windows® laptop, and Chromebook devices.

#### Your phone is your remote

By using your phone, there's nothing new to learn — stream your apps, your playlists, your favorite artists — without new log-ins or downloads. It's simple to browse, queue, and control from anywhere in the home.

#### Tap the Cast button

Simply tap the Cast button from your own mobile device to start streaming music to your speaker. Search, play, pause, and more right from your phone.\*

\*Device should be on the same Wi-Fi network.

#### 100+ Chromecast enabled apps

Choose from millions of songs from popular music services like Google Play Music, Spotify, Deezer, TuneIn and 100+ more. Discover more apps at... [google.com/cast/apps](http://google.com/cast/apps)

Set up your speaker on your phone or tablet [google.com/cast/setup](http://google.com/cast/setup)

# Settings

This menu contains various setup/configuration menus as shown below.

## SETTINGS

- » **Network**
- » **Firmware**
- » **Audio**
- » **Standby Mode**
- » **Automatic Power-down**
- » **Language**
- » **Display Brightness**
- » **Device Name**
- » **Edit Input Names**
- » **Factory Reset**

## NETWORK

This menu enables you to set your Evo 75/Evo 150's network settings, scan again for a connection to another wireless network, or to manually configure the network parameters. This is useful if you move your Evo 75/Evo 150 to a new location for instance.

By default the Evo 75/Evo 150 will be set for Automatic wired/wireless detection and automatic IP addressing (DHCP) which will work without setup in most circumstances (for Wi-Fi you will need to enter your WEP/WPA key if you have one).

In Auto mode the Evo 75/Evo 150 will look for a wired connection first and then scan for wireless connections if it doesn't find one. It will also try to obtain an IP address automatically from your router/DHCP server.

If you wish to make changes to your setup the Evo 75/Evo 150 display the following submenus.

- » **Set-up Wi-Fi**
- » **Enter network name**
- » **Current Config**
- » **Edit Config**
- » **Wi-Fi Strength (only available if connected wirelessly)**
- » **Wi-Fi Region**
- » **Wired/Wi-Fi**

### SET-UP WI-FI



This option scans all available Wi-Fi frequencies for wireless networks and allows you to connect to them.

The Evo 75/Evo 150 can support dual Band 2.4/5GHz networks

A list of available networks will be presented. If a particular network requires an encryption key, a  symbol will be seen at the end of the network name.

Select your local network using the Navigation/Select dial and press  button for enter.

The Evo 75/Evo 150 will then connect to the network using a saved key (if you have previously set one) or present you with an alphanumeric entry menu. Here you can enter the network key you set up when setting up your wireless network.

Select each character in turn using the Select dial and then press  or navigate to the  symbol and press Select dial to enter that key. If you make a mistake, press  to go back one character.

The Evo 75/Evo 150 can handle keys in WEP, WPA and WPA2 formats (the choice of format is made by appropriate settings on your router) and automatically generates the right format from your text according to the router request.

### ENTER THE NETWORK NAME

This option allows the Evo 75/Evo 150 to search for and connect to a particular network name only.

Type your network name in using the alphanumeric entry screen.

If no matching network is found 'Network not found' will be displayed.

### CURRENT CONFIG

This menu firstly displays the IP mode (static or dynamic). This will be Auto/DHCP (i.e. dynamic, this is the default) or alternatively Static IP.

For either mode by turning the Navigation/Select dial the Evo 75/Evo 150 will scroll through the various current IP parameters, for instance the ESSID of the current wireless network, Wired and Wireless MAC addresses, current IP address, (Sub)Netmask, Gateway address etc.

### EDIT CONFIG

This menu allows the selection of IP mode between static or dynamic (Auto/DHCP). Auto/DHCP is recommended for most people in most circumstances. Static IP requires quite a bit of knowledge about IP networks, and is for advanced users only.

The default setting is thus Auto/DHCP, here the Evo 75/Evo 150 obtains its IP address each time you switch in on by a process called DHCP which means it is different each time it is acquired. This process is completely automatic and much simpler than implementing Static IP.

However sometimes it is useful (especially in large networks) to know the exact IP address of each device, this can only be done by using static IP.

When using Static IP you will also need to enter the network mask you wish to use and the addresses of your gateway and DNS service, note there is no way for Cambridge Audio to know what these are in your network. Only select static IP if you know exactly what you are doing!

To set static IP, select the 'Settings > Network > Edit Config' menu.

The Evo 75/Evo 150 will now display 'Auto (DHCP)? YES/NO'. Turn the Evo 75/Evo 150's rotary dial to select 'NO' and then press SELECT.

You will now be able to enter the fixed IP address you wish to give your Evo 75/Evo 150 by using the rotary dial to select the desired numbers followed by pressing Navigation/Select dial to end inputting the address.

The Evo 75/Evo 150 will now prompt you to enter the required network mask for the network. You will be able to enter this in the same way as before for entering the IP address.

You will now need to enter the default gateway's IP address used by the Evo 75/Evo 150 on the network.

Finally, you will need to enter the DNS IP address for the Evo 75/Evo 150. On some networks, you may need to enter your ISP's DNS IP address, which should be available on your ISP's support page on their website.

After entering the above information, the Evo 75/Evo 150 will now try to connect to your network. If you wish to use DHCP again simply select 'Settings > Network > Edit Config' and then set the 'Auto (DHCP)? YES/NO' to 'YES'.

### WI-FI STRENGTH

Displays the strength of the received Wi-Fi Signal.

**Note:** If Wi-Fi has been turned off (Ethernet mode only) the signal strength will show as 0%.

### WI-FI REGION

Different parts of the world use slightly different frequencies for Wi-Fi. For best performance you should set the Evo 75/Evo 150 to the region you live in, the current options are US, Spain, Europe (i.e. other than Spain), Japan.

### WIRED/WI-FI CONNECTION

It is possible to connect your Evo 75/Evo 150 to your network via an available Ethernet connection (RJ45) or via a Wi-Fi router. By default the unit is in AUTO mode, each time you turn the unit it looks for the presence of a wired connection, and tries to use this, if none is present or it cannot connect it then tries to use the wireless connection and so on. In Auto mode once the Evo 75/Evo 150 has established a certain type of connection to the network, then this type of connection will remain in use while the Evo 75/Evo 150 is on.

You can alternatively configure the Evo 75/Evo 150 to permanently only use the wired or wireless connection from the Evo 75/Evo 150's 'Network' menu, select 'Wired/Wireless'. This menu will present you with three options: 'Auto', 'Wired Only' and 'Wireless Only'.

Selecting 'Wired Only' will cause the Evo 75/Evo 150 to reboot and then only use its Ethernet connection to communicate with the network. Selecting the 'Wireless Only' will cause the Evo 75/Evo 150 to reboot and only use its Wi-Fi connection. Selecting the 'Auto' option means the Evo 75/Evo 150 will try both and settle on the one it can make work as described above.



## FIRMWARE

This menu item displays some hardware/software version numbers for your Evo 75/Evo 150. Turn the rotary dial to scroll through the various items.

The Service Pack is the currently loaded firmware software. It's a good idea to note this down if you need to contact our technical support people as they may request it.

The Serial Number and Product Code are not normally required by the technical support team.

**Note:** This Serial Number is not the same as the physical serial number on the back of the product itself.

- » **Update firmware**
- » **Version**

### UPDATE FIRMWARE

Use this option to download new firmware for the Evo 75/Evo 150 from Cambridge Audio over the Internet.

If you select this item the Evo 75/Evo 150 will contact our server and see if a newer version of software is available ('Update firmware' will be shown in the display).

If new software is found the Evo 75/Evo 150 will prompt you and ask if you want to download it or not. It is a good idea to update the firmware from time to time to take advantage of any bug fixes or new features. At this stage, you can press the Evo 75/Evo 150's **i** button to cancel the firmware upgrade. A Firmware upgrade may take several minutes.

#### **Note:**

– It is very important that once the Firmware upgrade has started you do not switch off the power to the Evo 75/Evo 150 until the operation is complete otherwise the Evo 75/Evo 150 may become permanently damaged.

– Also do not interrupt the network or internet connection by removing the Ethernet lead or switching off your router etc.

### VERSION

This menu item displays some hardware/software version numbers for your Evo 75/Evo 150. Turn the rotary dial to scroll through the various items.

The Service Pack is the currently loaded firmware software. It's a good idea to note this down if you need to contact our technical support people as they may request it.

## AUDIO

This menu contains a setup configuration as shown below.

- » **USB Audio Class**
- » **Audio Output**

Whenever the Evo 75/Evo 150 is showing its 'Now playing' screen turning the rotary controller knob will adjust the volume. Pressing **i** to access the menu system allows the use of the rotary controller for menu browsing. If you are in a menu and need to adjust the volume immediately simply press the **i** button to go straight to 'Now playing' and then use the rotary controller.

Maximum volume is shown as "0dB" on the display. Reductions in volume away from maximum are shown in the form of negative numbers i.e. "-12dB". The larger the negative number, the larger the signal reduction so the quieter it will be. A muted or silent output is shown as "MUTE". The volume screen is shown briefly when the volume is changed, after which it times-out to the previously displayed screen.

The last used volume setting is memorised when the unit powered off.

### USB AUDIO CLASS

USB Class options enable Evo 75/Evo 150 compatibility with both USB Audio 1.0 and USB Audio 2.0 interface formats. The default setting is USB Audio 1.0 which will work driverlessly with most operating systems for 16-24 bit content at 32-96kHz. Note USB Audio 2.0 requires a driver to be loaded for Windows. Without this selecting USB Audio 2.0 will normally give no output. See earlier section on USB Audio for advanced users.

### AUDIO OUTPUT

- » **Speaker A**
- » **Speaker B**
- » **Speaker AB**
- » **Headphones**
- » **Bluetooth**

### BLUETOOTH AUDIO OUTPUT

#### » **Scan for devices.**

Selecting this allows the Evo 75/Evo 150 to output wireless Bluetooth audio to most bluetooth receive devices.

### PAIRING

follow your Bluetooth speaker/receive devices instruction to start pairing mode. your device's name come up on Evo 75/Evo 150's Bluetooth device list, select it will be paired with the Evo 75/Evo 150.

Note: Your device can only be paired and connected to the Evo 75/Evo 150 while the Bluetooth output is selected.

# Power

### STANDBY MODE

- » **Network Standby**
- » **ECO Mode**

Standby mode options enable Evo 75/Evo 150 with both Network Standby and ECO Mode. The default setting is ECO mode.

#### **Network Standby on**

Network Standby mode, when enabled, allows Evo 75/Evo 150 to enter a lower power suspended state using the Standby/On button. The display is turned off and many of the internal processes and circuits are disabled to reduce power consumption. However the difference between Network Standby and ECO mode is that in Network Standby mode, power remains connected to the main controller, Ethernet and Wi-Fi sections.

In Network Standby mode, networking functionality remains alive in the background. This means that Evo 75/Evo 150 can be quickly woken up out of the suspended state into an operational state using not only the front panel, the infra-red remote and the control bus, but also the iOS app running on the iPhone or iPad. This is not possible when the unit is in full Standby ECO mode.

To enable Network Standby mode using the Standby/On button, it must first be activated within the setup menus. Go to "Settings -> STANDBY MODE -> Network Standby" and set to "On".

Short presses of the Standby/On button then toggle between On and Network Standby mode modes.

**Note:** after putting the unit into Network Standby mode, you will not be able to wake the unit into full On mode until 5 seconds have d.

**Full low power (ECO MODE) standby can still be activated by keeping the Standby/On button pressed for more than two seconds. A subsequent press of Standby/On turns the unit fully on, but remember that this can't be done over the network (i.e. from the iOS app) and that it takes longer to reach the full operational state.**

### AUTOMATIC POWER DOWN

The Evo 75/Evo 150 will switch itself off after 15 minutes if it is not playing anything and there has been no user interaction with it during this time. As a default this is set to 15 minutes, but you can increase or decrease this time, or turn this feature off altogether if desired.

The Auto Power Down setting can be found in Settings > Automatic Power-down. There, using the rotary dial you can adjust APD from OFF to 2hr, in 5 minute increments. press **i** button to accept the new APD setting.

# StreamMagic app

## LANGUAGE

Allows you to change the display language used.

A list of the currently supported languages will be shown. Select your preferred one and press enter.

**Note:** The Evo 75/Evo 150 will then restart in order to start again in the new language, this will take approximately 30 seconds.

## DISPLAY BRIGHTNESS

Alters the brightness of the Evo 75/Evo 150 display backlight. There are three brightness levels; off, dim, bright and an option to switch-off the backlight.

When the display is set to OFF, nothing will be displayed onscreen until a selection is made via the front panel or remote control. The display will then re-activate allowing you to browse the menu and make your selection. The display will then automatically switch back off after a few seconds if no further selections are made.

## DEVICE NAME

This menu allows the setting of the declared UPnP Client name for your Evo 75/Evo 150.

This is the name other UPnP devices (such as control points and remote apps etc.) will display when they see the Evo 75/Evo 150.

The default name will be 'Evo 75/Evo 150' but can be changed to any name you can easily recall such as 'Dads Evo 75/Evo 150' or 'Kitchen' etc.

## EDIT INPUT NAMES

This allows you to customise the names associated with each input so that they correspond to the actual device names connected to them.

There are nine digital inputs:

- **A1 - XLR**
- **A2 - Aux in**
- **A3 - MM Phono**
- **A4 - USB Media**
- **D1 - Coax in**
- **D2 - Optical in 1**
- **D3 - Optical in 2**
- **D4 - USB audio**
- **D5 - TV ARC**

Each input is named as default by its input type. To rename an input, go to "Settings -> Edit Input Names", highlight the desired input and select it to rename. The screen changes to a list of letters, with the current name displayed at the top. To delete existing letters press the "Stop/Delete" button at the bottom left of the display. Navigate through the letters and select each letter in turn to rename the input. When finished, select the "Return ◀" symbol at the end of the letter list (you can press the "ⓘ" button on the right hand side of the display to jump to it). The name is then saved and the display returns to the Edit Digital Input Names menu screen.

## FACTORY RESET

Puts all the settings back to their defaults as they were when they left the factory.

The Evo 75/Evo 150 will ask you if you are sure you want to proceed before performing a reset.

**Note:** If you perform a factory reset, you will lose any saved WEP/WPA keys for your wireless network connection.

The StreamMagic app is a free Apple or Android application that allows wireless control of the Evo 75/Evo 150 or other Stream Magic powered Cambridge Audio products.

The application allows full control of the Evo 75/Evo 150 including Internet Radio, Streaming Services, UPnP Media, Presets, Queuing and more.

It also supports display of Album artwork and Station logos (where available).

To use the StreamMagic app you will need a Wi-Fi network or Access point for the application to connect to; the connection from your router to the Evo 75/Evo 150 can then be either Wi-Fi or Etherne.

Search for 'StreamMagic' on the App Store/Play Store to download the latest version.

The Evo 75/Evo 150 allow the user to control playback volume via the StreamMagic app.





# Technical specifications

## Evo 75

POWER OUTPUT	75W into 8 Ohms
AMPLIFICATION	Class-D
DAC	ESS Sabre ES9016K2M
FREQUENCY RESPONSE	20Hz -20kHz +0/-3dB
ANALOGUE AUDIO INPUTS	1 x RCA,
DIGITAL AUDIO INPUTS	1 x TOSLINK optical in 1, 1 x S/PDIF coaxial, Bluetooth (integrated), 1 x TV ARC,
BLUETOOTH	4.2 A2DP/AVRCP supporting SBC, aptX and aptX HD codecs
COMPATIBILITY	TOSLINK optical: 16/24bit 32-96kHz PCM only, S/PDIF coaxial: 16/24bit 32-192kHz PCM only, UPnP, Local USB media, Airplay 2, Chromecast built-in, Internet Radio, Spotify Connect, TIDAL, Qobuz, Amazon Music, RoonReady.
AUDIO FORMATS	ALAC, WAV, FLAC, AIFF, DSD (x256), WMA, MP3, AAC, HE AAC AAC+, OGG Vorbis
OUTPUTS	Speakers A, 3.5mm headphone, Preamp Output, Subwoofer Output, Bluetooth: 4.2 A2DP/AVRCP supporting up to aptXHD
ETHERNET	IEEE 802.3, 10 Base-T or 100 Base-T
WI-FI	Dual Band 2.4/5GHz
MAX POWER CONSUMPTION	400w
STANDBY POWER CONSUMPTION	<0.5w
DIMENSIONS (H X W X D)	90 x 305 x 305 mm
WEIGHT	5Kg

## Evo 150

POWER OUTPUT	150W into 8 Ohms
AMPLIFICATION	Class-D
DAC	ESS Sabre ES9018K2M
FREQUENCY RESPONSE	20Hz -20kHz +0/-3dB
ANALOGUE AUDIO INPUTS	1 x RCA, 1 x Balance XLR in, 1 x MM Phono
DIGITAL AUDIO INPUTS	1 x TOSLINK optical in 1, 1 x TOSLINK optical in 2, 1 x S/PDIF coaxial, Bluetooth (integrated), 1 x TV ARC,
USB AUDIO INPUT	USB Type B conforming to USB Audio Class 1 or USB Audio Class 2 (user selectable)
BLUETOOTH	4.2 A2DP/AVRCP supporting SBC, aptX and aptX HD codecs
COMPATIBILITY	TOSLINK optical: 16/24bit 32-96kHz PCM only, S/PDIF coaxial: 16/24bit 32-192kHz PCM only, USB Audio Class 1: Up to 24-bit 96kHz (asynchronous) USB Audio Class 2: Up to 32 bit 384kHz (asynchronous) and up to DSD-256 UPnP, Local USB media, Airplay 2, Chromecast built-in, Internet Radio, Spotify Connect, TIDAL, Qobuz, Amazon Music, RoonReady.
AUDIO FORMATS	ALAC, WAV, FLAC, AIFF, DSD (x256), WMA, MP3, AAC, HE AAC AAC+, OGG Vorbis
OUTPUTS	Speakers A+B, 3.5mm headphone, Preamp Output, Subwoofer Output, Bluetooth: 4.2 A2DP/AVRCP supporting up to aptXHD
ETHERNET	IEEE 802.3, 10 Base-T or 100 Base-T
WI-FI	Dual Band 2.4/5GHz
MAX POWER CONSUMPTION	700w
STANDBY POWER CONSUMPTION	<0.5w
DIMENSIONS (H X W X D)	90 x 305 x 305 mm
WEIGHT	5.3Kg

# Troubleshooting

If you experience any trouble with your Evo 75/Evo 150, then you may find it useful to visit the help section on our webpage at:

<https://techsupport.cambridgeaudio.com/>

General Help guidelines:

If you have trouble connecting the Evo 75/Evo 150 to your network, these steps may help to resolve the problem:

- Confirm that a connected computer can access the Internet (i.e. can browse the web) using the same network.
- Check that a DHCP server is available, or that you have configured a static IP address on the Evo 75/Evo 150. You can configure a static IP address on the Evo 75/Evo 150 using the menu item 'Settings -> Network Config -> Edit Config', and then select 'No' for 'Auto (DHCP)'. DHCP is however the recommended method.
- Check that your network's firewall is not blocking any outgoing ports. As a minimum, the radio needs access to UDP and TCP ports 80, 554, 1755, 5000, 6000 and 7070.
- Check your access point does not restrict connections to a particular MAC addresses. You can view the radio's MAC address using the menu item 'Settings -> Network Config -> View Config -> MAC address'.
- If you have an encrypted Wi-Fi network, check that you have entered the correct key or passphrase into the Evo 75/Evo 150. Remember that text-format keys are case sensitive. If, when attempting to connect to an encrypted network, your Evo 75/Evo 150 displays: 'Wireless error' followed by a 5-digit number, then please ensure that you enter the correct passphrase for the network. If the problem persists, then you may need to consult your network configuration.

If your Evo 75/Evo 150 can connect to the network successfully, but is unable to play particular Stream Magic stations, it may be due to one of the following causes:

- The station is not broadcasting at this time of the day (remember it may be located in a different time zone).
- The station has reached the maximum allowed number of simultaneous listeners.
- The station is not broadcasting anymore.
- The link in our database is simply out of date.
- The Internet connection between the server (often located in a different country) and you is slow.
- Try using a computer to play back the stream via the broadcaster's web site.

If you have problems with UPnP playback always check the following:

- Ensure your chosen UPnP server software is capable of serving the file type you are trying to access. Some servers do not serve FLAC for instance.
- The Evo 75/Evo 150 can only play non DRM files. Files that have DRM controls cannot be played by the Evo 75/Evo 150. Some servers may be able to authorise and de-crypt Microsoft Playsforsure before then serving the content to the Evo 75/Evo 150 but this operation is not guaranteed as it is purely a function of the server.
- If attempting to play 24-bit WAV or FLAC content note a wired Ethernet connection is normally required for reliable operation due to bandwidth considerations.
- Check the Evo 75/Evo 150 are capable of playing back the file type you are trying to access. WMA, AAC, MP3, Vorbis, FLAC and WAV can currently be played. The Evo 75/Evo 150 does not support ALAC, WMA Pro, WMA lossless, RAW, AU or other file types not mentioned.

If you have problems with USB Media playback always check the following:

- Check the Evo 75/Evo 150 are capable of playing back the file type you are trying to access. WMA, AAC, MP3, Vorbis, FLAC and WAV can currently be played.
- The Evo 75/Evo 150 does not support ALAC, WMA Pro, WMA lossless, RAW, AU or other file types not mentioned.
- For USB Media the Evo 75/Evo 150 can only play non DRM files. Files that have DRM controls cannot be played.
- Check that your device does not require more than 1A if it is powered from the USB socket itself.
- Check your device is formatted in FAT32/NTFS format.
- The way you organise your USB media affects the size of internal database the Evo 75/Evo 150 needs to build dynamically as you browse content. Good practice is to create folders for Artists within which you should have a sub folders for each Album which then containing the tracks for that Album. Libraries with thousands of tracks in one folder will progressively slow down the Evo 75/Evo 150s media browsing.

For all servicing, in or out of warranty, please contact your dealer.



[WWW.CAMBRIDGEAUDIO.COM](http://WWW.CAMBRIDGEAUDIO.COM)

Gallery Court, Hankey Place  
London  
SE1 4BB  
United Kingdom

Cambridge Audio is a brand of Audio Partnership Plc.  
Registered in England No. 2953313

© 2020 Cambridge Audio Ltd