

IRIVER

L1000

Astell&Kern

INSTRUCTION BOOK

User Guide

Package Contents

Components may be changed without prior notice to improve the performance or quality of the product.

ENGLISH

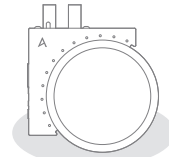

L1000

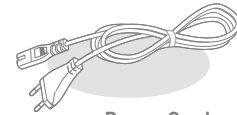

Power Cord

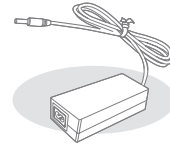

Adapter

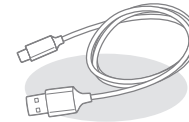

Micro-USB Cable



User Guide
& Warranty

Power Cord & Adapter: Connect to the product and wall outlet to supply power.

Micro-USB Cable: Use to connect to a computer or compatible music source.

User Guide: Overview of product functionality.

Warranty: Please keep the product warranty in case warranty service is needed.

Description of Each Part

The appearance of the product as well as the printed and engraved information may vary depending on the model.

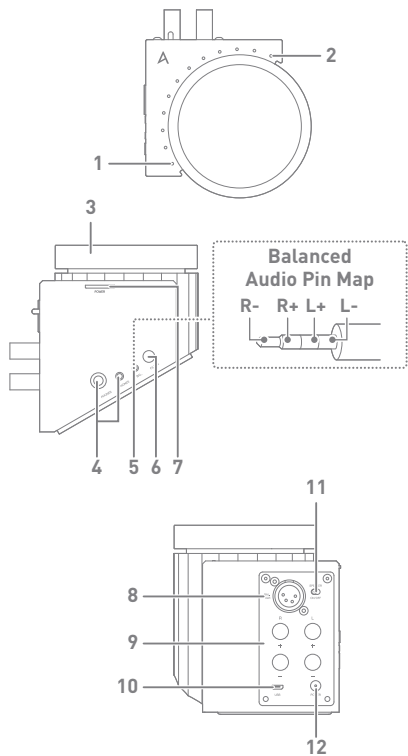

1	Filter LED	Indicates the selected filter. <ul style="list-style-type: none"> • Blue LED - Neutral Filter • Green LED - Bass Sound Filter • Red LED - Boosted Gain Filter
2	Volume LED	Volume level indicator.
3	Volume Wheel	Turn the wheel to adjust sound volume.
4	Headphone and Earphone Port	Connect earphones and headphones with 3.5mm/6.3 mm terminal for audio output.
5	Balanced Audio Port	Connect earphones or headphones with 2.5mm balanced jack for audio output.
6	Filter button	Press to select filters.
7	Power button	Turns power ON/OFF.
8	XLR Balanced Port	Connect earphones or headphones with 4-pin XLR balanced jack for audio output.
9	Speaker Port	Output sound by connecting the product to speakers.
10	Micro USB Port	Transmit data by connecting the product to a computer or music source device.
11	Speaker switch	Turn ON/OFF the output function of a connected speaker.
12	Power Port	Connect power adapter.

Power Cable Management

Power ON/OFF

1. Connect the adapter to power cord.
2. Connect the adapter cable to [Power] on the back of the product.
3. Connect to power plug and press [Power].
4. When volume and filter LED lights are on, the product is booted.
5. Long-press (4 seconds) the [Power] button to turn the device OFF when it is turned on.

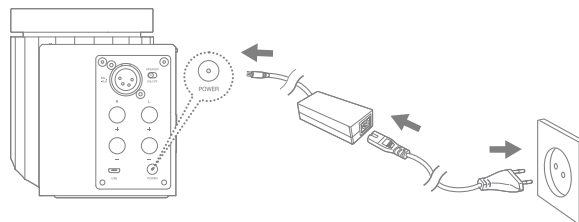

! Be sure to only use an officially-certified 12V 5A adapter. Using an adapter with specifications lower than 12V 5A may damage the product. After connecting the adapter and power cord to the product, insert the power plug into an available outlet. To avoid malfunction or damage to the device, only use the power cord and the adapter supplied with the product. Unplug the power supply from the outlet when the device is not in use for an extended period. Be sure to check nearby outlets and use the proper power plug.

Connecting Earphones/Headphones

- Connect earphones or headphones to [BAL], [PHONES], [BAL,-XLR] Port on the side or back of the product.
- Connect earphones or headphones that have 2.5mm balanced port to [BAL] Port on the side of the product.
- Connect headphones that have 4-pin XLR balanced jack to [BAL.-XLR] Port on the back of the product.
- You can use a variety of earphones/headphones that suit 2.5 Φ , 3.5 Φ , 6.5 Φ , 4-pin XLR Balanced.

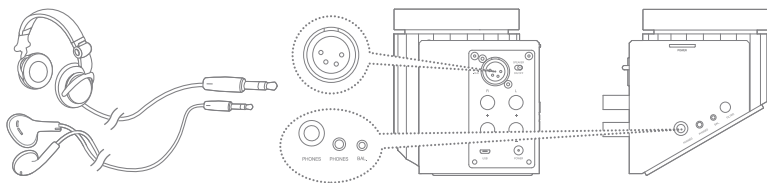

XLR Balanced Cable Pin Map

Balanced cable used for professional audio interface has a better capability for dealing with noise and transmits sound a long distance.

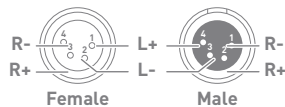

- ! Maintain low to moderate volume levels when connecting earphones or headphones. Exposure to high volume levels for extended periods may damage your hearing.
- When connecting earphones/headphones, set the [Speaker] switch on the rear of the device to OFF.
- When connecting more than two earphones/headphones, the sound is output to the earphones/headphones of the last connected terminal.
- When connecting to the XLR balanced terminal, all earphone/headphone jacks on the side of the product should not be connected.

Connecting Speakers

- Connect the speaker cables to L/R(+/-) Port on the back of the product.

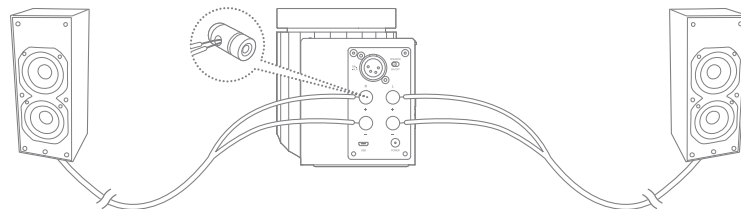

- ! Only connect to the speaker when the product is turned off. We recommend the use of an audio connector cable of good quality. Use of an ordinary cable or unauthorized cable may cause the speaker to malfunction. Standard thickness audio-only cables are recommended.
- Maintain low to moderate volume levels when connecting to speakers. High volume levels distort sound and may damage the speaker.
- Avoid excessive force when connecting a speaker cable to a terminal. Doing so may cause damage to the device.
- Be sure that the speaker cable is securely connected to the terminal.
- When connecting speakers, set the [Speaker] switch on the rear of the device to ON.

Connecting Input

Connecting to a Computer

1. Connect [USB] Port on the back of the product to a computer with the supplied Micro USB cable.

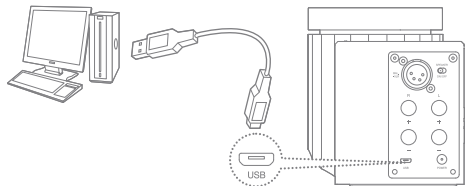

Disconnecting from a Computer

1. Disconnect the Micro USB cable only after the transfer between the product and PC has completed.

! Only use the USB cable supplied with the product for data transmission. Using an unauthorized cable may cause malfunction.
Stop all functions before connecting the computer and USB cable for data transmission.
Please connect the product to the high-power USB 2.0 port. Connecting to a keyboard or USB hub without its own power supply may not be a satisfactory connection with the computer.
Disconnecting the USB cable for data transmission from the computer during an operation may corrupt data stored on the product.
When the product is disconnected from the input source device (PC or AK Portable Player), the power automatically turns off after about 10 minutes.

Connecting an AK Portable Player

1. Connect [USB] Port on the back of the product and AK Portable Player with OTG cable.

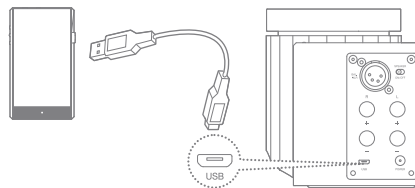

2. Connect by clicking External USB icon on AK Portable Player.

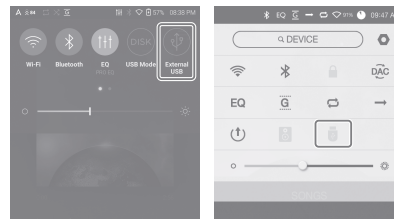

! For instructions on OTG cable, please refer to the cable manufacturer's manual. OTG cable is not included in the product package. Please purchase it separately. Connections may be unstable, depending on which OTG cable is used. For instruction on how to use USB audio, refer to the manual of the AK player you are trying to connect.
When connecting an AK portable player to USB audio output, the volume should be fixed at the MAX and you can adjust the volume with the volume wheel on L1000. Please see Line Out feature on AK player.

USB DAC Installation

The USB DAC functionality allows L1000 to be recognized as the computer's sound card. Music from the computer is played through the product's earphone/headphone/speaker port for an enhanced listening experience.

USB DAC Specifications

- USB DAC Supported OS
 - + Windows 7 (32/64-bit) / Windows 8 (32/64-bit) / Windows 10 (32/64-bit) / Mac OS 10.7 (Lion) or higher OS version
- USB DAC Support Specifications
 - + Supported formats: PCM [8 ~ 384kHz (8/16/24/32bit)] / DSD [2.8/5.6/11.2MHz]
- Adjust the sound volume output by using the L1000's volume wheel.

! Sound will not play back for files that exceed the supported formats. Playback may stutter when computer performance is slow or the USB connection is experiencing heavy usage. There may be issues with audio-to-video synchronization during video playback depending on the sound quality and operating environment. Volume cannot be adjusted via the Windows volume control during native DSD playback. The volume wheel on the product must be used to adjust the volume. Install a dedicated driver to use the L1000 as a USB DAC. The driver file can be downloaded from the Astell&Kern website: [<http://www.astellnkern.com> > Support > Download].

USB DAC Installation

1. Run 'Setup.exe' from Drivers.
2. Click [Browse] to select the driver destination folder and click [Install].
3. When the following screen is displayed, click [Finish] to complete the installation.

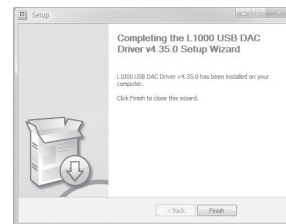
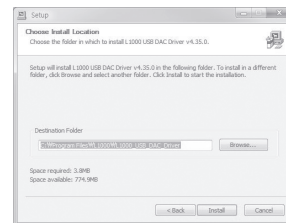
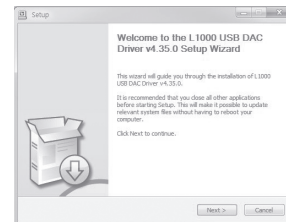

> After driver installation >

4. Change the default 'Sound Output' product according to the operating system as seen in the images below.
- XP: Control Panel > Sound and Audio Devices > Audio tab > Change the default audio device under 'Sound playback' to [L1000 USB DAC].
 - 7/8/10: Select [L1000 USB DAC] under Control Panel> Sound > Playback tab and select [Set as default device].
-
- MAC OS X: System Preferences > Sound > Output tab > Select [L1000 USB DAC].

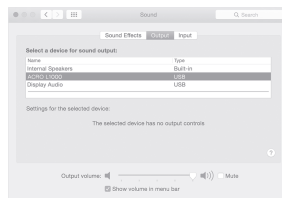
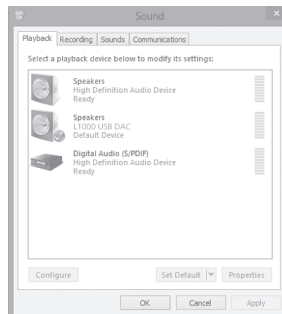

! This step is necessary only when using L1000 with USB DAC for the first time. No follow-up measure needs to be taken to select L1000 for sound output. For high-quality audio playback on Windows 7/8/10, it is recommended to click [Properties] in [L1000 USB DAC] under Control Panel > Sound tab and change the basic mode to [24bit, 192kHz [studio quality]] under Advanced tab.

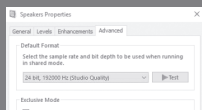

Troubleshooting **Check for solutions to common problems.**

1. The product won't turn on.
 - Check whether the power adapter is properly connected.
 - Please use 12V 5A adapter.
 - You are recommended to use the supplied adapter and power cord.

2. There is no sound, or there is static/interference.
 - Check whether the volume is set at [0].
 - Check whether the earphones/headphones/speakers are plugged in properly, and make sure the port connection is not obstructed by dust or debris.
 - Check the volume of the product to which it is connected.
 - Verify that the music file is not corrupted.
 - Please check whether there is any device causing frequency interference nearby.
 - Check the speaker ON/OFF switch direction.

Safety cautions

To ensure safe product usage, check the [Safety Precautions] before using the product.

Explanations for symbols: The safety precautions are divided into "Warning" and "Caution" as follows:

 **WARNING** indicates a serious risk.  **CAUTION** indicates a potential hazard.





Safety symbols



 indicates "prohibited" or "matters that should not be done."

 indicates "necessary steps" or "perform as instructed."





Use

WARNING

-  Do not attempt to disassemble, repair, or modify the product.
 - iriver does not assume any responsibility for problems that arise due to unauthorized product disassembly, repair, or modifications.
-  Do not insert any metal objects (coins, hairpins, etc.) or flammable material into the product.
-  Avoid touching the power cord during lightning strikes or thunderstorms.
 - This may cause a fire or electric shock.
-  Discontinue use of this product immediately if it does not operate normally or a failure occurs.
-  If water or other liquids enter the product, immediately disconnect the power cord from the outlet, wipe with a dry cloth, and then refer to the nearest Service Center for customer support. If water-damage occurs please consult with the Service Center to determine if the product is deemed repairable. Regardless of current warranty status, repair will be considered as an out of warranty service.





-  When inserting a cable into any audio connection port, do not apply excessive force or impact to the plug.
 - This may damage the audio ports.
-  When connecting the USB cable, use a USB port on the back of the PC. Connecting to a poorly assembled or defective USB port may damage the product.
-  Never use chemicals or cleaning products on the product since they can damage the paint and surface coating.

CAUTION





-  Do not stand on the product.
-  Do not place heavy objects on the product.
-  Never attempt to insert an unauthorized cable into a connector.
-  Maintain low to moderate volume levels when connecting earphones or headphones.
 - Exposure to high volume levels for extended periods may damage your hearing.

Power Cable and Plug

WARNING



-  Do not connect/disconnect the power plug with wet hands.
-  Plug the power plug into a 110V ~ 220V (50Hz ~ 60Hz) AC outlet.
-  Unplug the power plug from the outlet before attempting to clean the power plug pins or mounting surface.
-  Observe the following when handling the power cord:
 - Do not damage or modify it. (e.g.: extension) /
 - Do not subject the cord to excessive heat or heavy weight. /
 - Do not pull the cord. / Do not attempt to jam the cord into a tight space. /
 - Do not forcibly bend the cord. /
 - Do not twist the cord. / Do not tie multiple power cords together.
 - Doing so may cause a fire or electric shock.

CAUTION

-  Do not use any power cords other than the one supplied with the product.
-  Do not use the supplied power cord with any other products.
 - Doing so may cause a fire or electric shock.
-  Plug the power cord into a grounded power outlet.
-  Hold the power plug firmly when disconnecting it from the outlet.
-  Disconnect the power cord from the outlet when the product is not being used for an extended period.
 - Doing so may cause a fire or electric shock.

Installation

WARNING

-  To reduce the risk of fire or electric shock, do not expose this product to rain or moisture. Avoid exposing the product to water, and do not place objects filled with liquids, such as vases, on top of the product.
-  Do not place the product in the following locations:
(Doing so may cause a fire or electric shock.)
 - locations where water can splash or humid locations such as bathroom /
 - locations where rain or fog can permeate / outdoor locations in the rainy season /
 - locations with high temperature such as near fireplace or heaters /
 - locations with direct sunlight / locations with dust, oil or lots of smoke (e.g.: kitchen) /
 - locations with too high or too low temperatures (-5°C ~ 40°C) or locations experiencing abrupt changes in temperatures /
 - locations with strong vibrations unstable conditions, such as a shaky table or sloped surface /
 - locations with magnetic objects, such as magnets, TV, monitors, and/or speakers /
 - locations with corrosive gas (e.g.: sulfite, hydrogen sulfide, chlorine, ammonia)

 If you notice any color changes on a TV in the vicinity of this product or audio interference from the TV, relocate the product farther away from the TV.

Copy- right

iriver Limited retains the rights to patents, trademarks, copyrights, and other intellectual property rights related to this manual. This manual may not be copied or duplicated in any form or by any means without the prior written consent of iriver Limited.

Using or reproducing, in whole or part, the contents of this document is subject to penalties. Software, audio, video, and any other copyrighted contents are protected in accordance with relevant copyright laws. The user accepts all legal responsibility for the unauthorized reproduction or distribution of the copyrighted contents from this product.

Companies, organizations, products, people, and events used in the examples are not based on actual data.

iriver has no intention to be associated with any company, institution, product, person, or incident through this instruction manual, and no such inference should be made. It is the responsibility of the user to comply with applicable copyright laws.

©1999 ~ 2017 iriver Limited. All rights reserved.

L1000 was designed and audio-tuned under the advice of MSD.

Certifi- cations

KCC / FCC / CE / CCC

Class B Device (Communication equipment for residential use): This is a Class B Device and is registered for EMC requirements for residential use. This product can be used in residential and all other areas.



FCCID : QDMDAM11

This device complies with Part 15 of the FCC Rules. Operation is subject to the following two conditions: (1) this device may not cause harmful interference, and (2) this device must accept any interference received, including interference that may cause undesired operation.

Disclai- mer

The manufacturer, importer, and distributor shall not be liable for any damage including accidental and/or personal injury due to the improper use or operation of this product.

The information in this user manual was written based on current product specifications. The manufacturer, iriver Limited, is adding new complementary features and will continue to apply new technologies in the future.

All specifications are subject to change without prior notice.

There is no warranty against data loss due to the use of this product.

Regis- tered Trade- marks

Windows 2000, Windows XP, Windows 7, Windows 8, Windows 10, and Windows Media Player are trademarks of Microsoft Corp.

Specifications

General		
Product Name	L1000 / DAM11	
DAC	AK4490 x2 (Dual DAC)	
Inputs	USB Micro-B input (PC&MAC)	
Outputs	PHONES Out (3.5mm, 6.3mm), Balanced Out (2.5mm-only 4-pole supported, 4-pin Balanced XLR), Speaker out (L/R binding posts x2)	
Sample Rate	PCM : 8kHz ~ 384kHz (8/16/24/32bits per Sample) DSD Native: DSD64(2.8MHz), Stereo / DSD128(5.6MHz), Stereo / DSD256(11.2MHz), Stereo	
Output Level	Unbalance 6Vrms / Balance 8.5Vrms (Condition No Load)	
Power Supply	12V adaptor	
Material	Aluminum	
Weight	32.45oz(920.7g)	
Dimension	4.44" [112.87mm][W] x 6.29" [160mm][D] x 4.43" [112.75mm][H]	
Audio		
Headphone / Earphone	Frequency Response	±0.064dB (Condition: 20Hz~20kHz) Unbalanced & Balanced / ±0.73dB (Condition: 10Hz~70kHz) Unbalanced & Balanced
	Signal to Noise Ratio	115dB @ 1kHz, Unbalanced / 116dB @ 1kHz, Balanced
	Crosstalk	108db @ 1kHz, Unbalanced / 138dB @ 1kHz, Balanced
	THD+N	0.003% @ 1kHz, Unbalanced / 0.001% @ 1kHz, Balanced
Speaker	Output	15W x2 (4ohm)
	Frequency Response	±0.32dB (Condition: 20Hz~20kHz, 4ohm, 1kHz, 10% THD)
	Signal to Noise Ratio	95dB (Condition: 4ohm, 1kHz, 10% THD)
	Crosstalk	110dB (Condition: 4ohm, 1kHz, 10% THD)

! Device specifications and appearance are subject to change without notice.