

Truck Wheel Balancer

With pneumatic lift platform

MODEL:TMG-TWB24

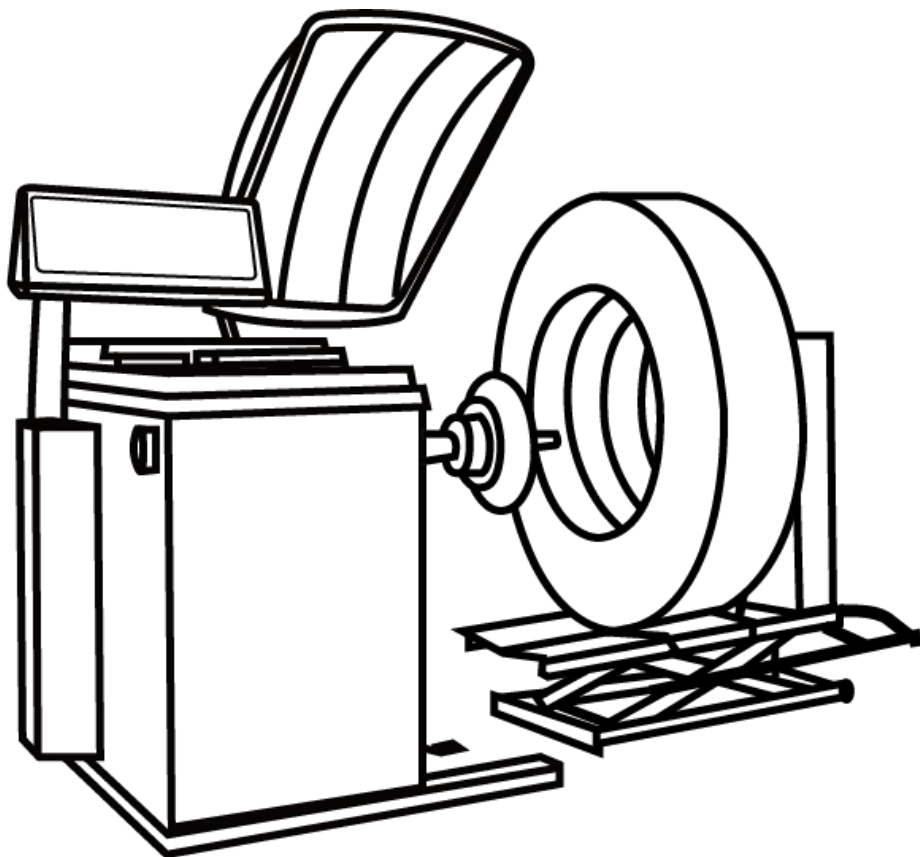

- Please read the product manual completely before assembly
- Check against the parts list to make sure all parts are received
- Wear proper safety goggles or other protective gears while in assembly

Missing parts or questions on assembly?

Please call: 1-877-761-2819 or email: cs@tmgindustrial.com

Do not return the product to dealer, they are not equipped to handle your requests

Contents

1.Summary of the balancing machine.....	3
1.1.Brief introduction of appearance.....	3
1.2.Performance and characteristic.....	3
1.3.Main technical parameters.....	4
1.4.Operating principle.....	4
2.Balancing machine installation guide.....	5
3.Use of balancing machine.....	6
3.1.Attention before using	6
3.2.Introduction of panel.....	6
3.3.Putting through the power and number input.....	7
3.4.Select and change the unit.....	8
3.5.Some examples about balancing.....	8
3.6.Options for mode of balancing.....	9
3.7.Precautions in the process of use and balancing experiences.....	10
3.8.Balancing experiences.....	10
4.Self-calibration.....	11
5.Function setting.....	13
6.Balancing machine self-testing function.....	13
7.Common failure codes and solutions.....	14
8.Accessories accompanying machines.....	15
9.Exploded drawing.....	16

1. Summary of the balancing machine

1.1. Brief introduction of appearance

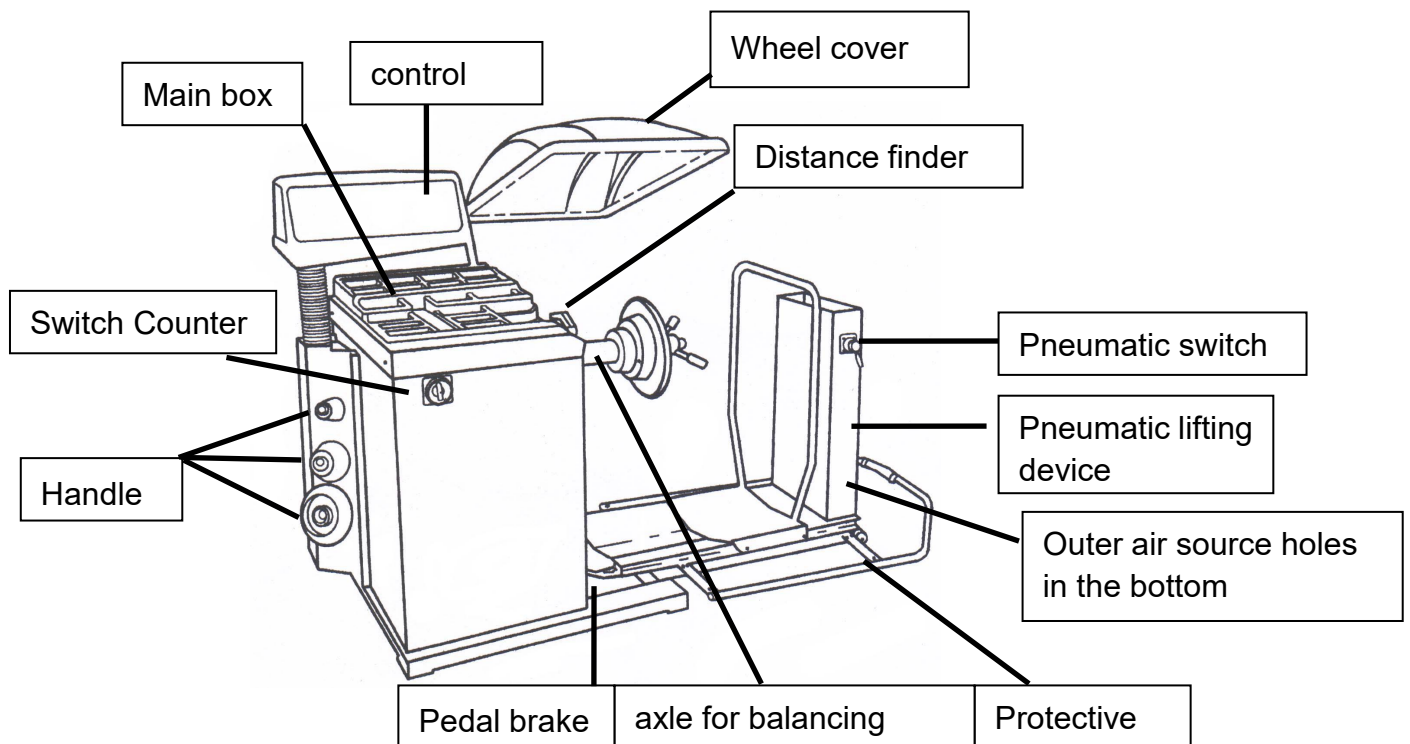

1.2. Performance and characteristic

- This machine adopts imported large-scale integrated circuit to make up the microcomputer system with high intelligence and high stability. This machine is equipped with the counterweight optimization procedure.
- Main shaft of balancing adopts imported bearing for transmission, it is processed accurately. It is wear-resisting and low noise.
- The most advanced motor driving system in 21st century in the world with extremely high stability.
- Test function of full-automatic dynamic balance and static balance.
- Functions to balance three kinds of aluminium alloy wheel rim.
- Balance precision is up to $\pm 1g$, balance takes at least 8 seconds each time.
- Functions of self correction and full automatic diagnosis.
- With pneumatic lifting device and international standard jig.
- With pedal positioning brake, stable positioning and convenient counterweight.

1.3. Main technical parameters

Scope of application	Garage, transportation company , Department motorcade, The professional service station of tire
Power supply	110~120V/60Hz 1PH
Machine motor	3/4HP
Maximum diameter of wheel	47"
Width of steel rim	5-1/2"~20"
Diameter of steel rim	13"~24"
Maximum weight of wheel	150kg
Measurement time	8 seconds each time
Working temperature	0~50℃

1.4. Operating principle

The CPU can only run the balancing operation when it receives the normal information from each unit. In the balance process, the CPU comprehensively analyzes the unevenness detected by the piezoelectric sensor and the Angle signal of the counting sensor, calculates the unbalance value, which is displayed by the LED, realizes man-machine dialogue through the keyboard, and achieves the tire balance.

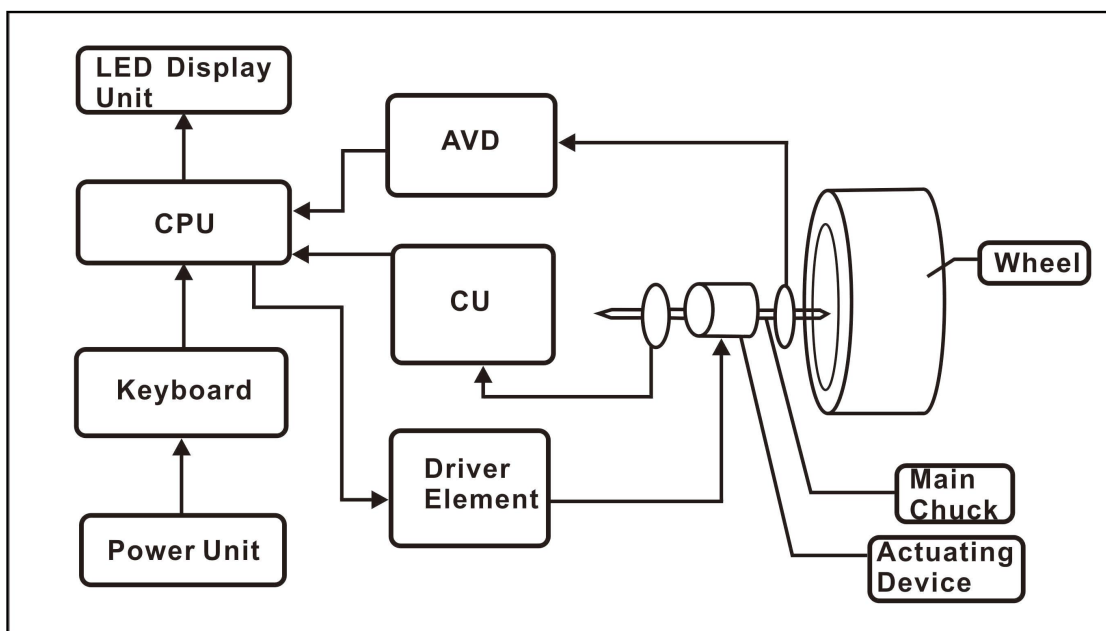

2. Balancing machine installation guide

1. Open the package, remove the connecting screw between the balancer and the bottom bracket of the packing case, lift-off balancing machine, place it on a flat, solid ground, there should be more than 800mm space around the balancing machine for the operating convenience.

2. Electrical connection (Must comply with the requirements of the country and region)

Operated by a professional electrician, the body box must be grounded.

2. Before connecting the main shaft of the balancing machine with the screw, wipe the connection between the spindle head and the screw first, then tighten it with a wrench.

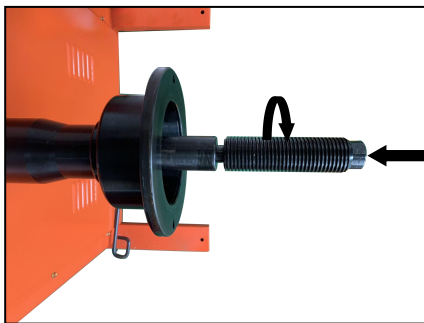

3. Loosen the screw, turn the control panel, adjust the Angle and then tighten the screw

4. Open the cover at the back of the machine and install the wheel cover as shown in the picture

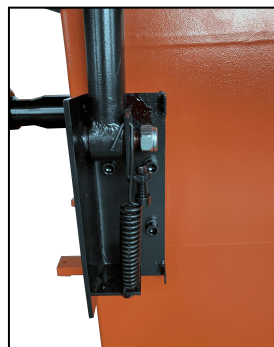

5. Installation the protective and wheel on the pneumatic lifting device, then contact the air source



3. Use of balancing machine

3.1. Attention before using

※ Carrying the balance machine can only lift the machine chassis , can't lift the main shaft in any case.

※ Balancing machine and Pneumatic lifting device must place at steady ground (can be fixed with expansion screw) and guarantee enough space all around or it will cause the balance error if the machine is unstable.

※ Outer power must have protective devices to prevent electricity leak, the machine case must be grounded (earth connection is in rear of the machine).

※ Balancing machine can't be placed in a moist environment , otherwise machine will be damaged.

※ While installing the lead screw on the shaft , clean the main shaft and lead screw level with alcohol or petrol first , then connect the lead screw to the main shaft and fasten by spanner

※ While balancing medium and small sized tire , choose suitable cone. Then lock the tire with cone and nut (inside of the tire is close to the machine case)

※ While balancing the large sized tire , first fasten clean matching device on the main shaft, then clamp the tire on the main shaft with cone which is suitable for the tire centre bore and balance tire.

※ While installing the large sized tire, pneumatic lifting device can be used to assist installation.

※ The external air source connected to pneumatic lifting device must guarantee to be about 115psi (moves the pneumatic switch to lift or drop).

(For unidentified name, please see brief introduction of appearance and accessories accompanying machines.)

3.2. Introduction of panel:

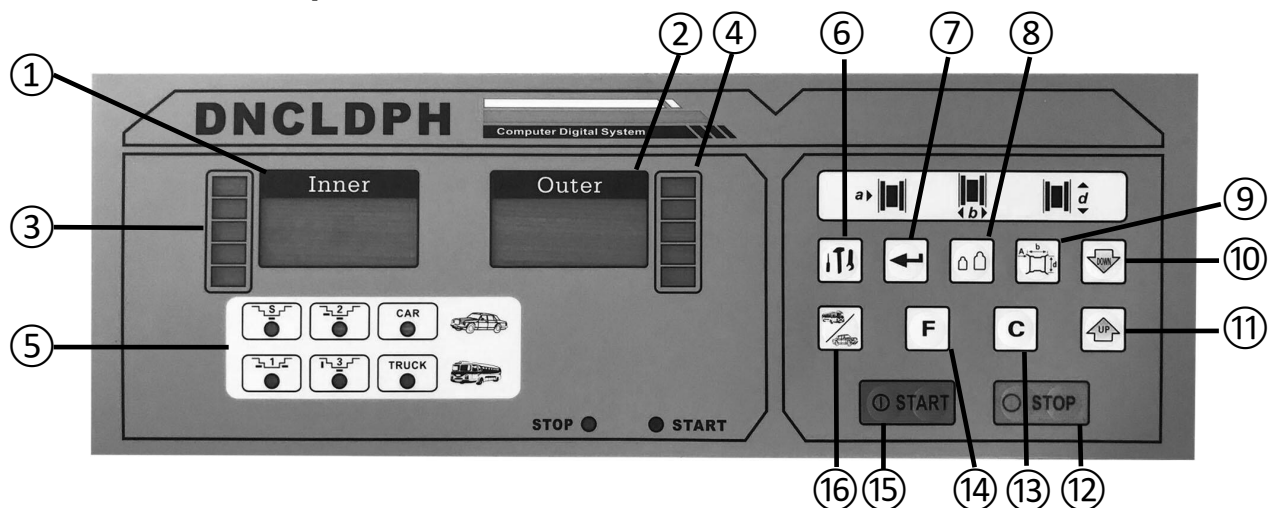

- ① indication for uneven edge inside wheel
- ② indication for uneven edge outside wheel
- ③ indication for uneven edge position inside wheel
- ④ indication for uneven edge position outside wheel
- ⑤ indication of balance mode
- ⑥ Data to debug key
- ⑦ Enter key
- ⑧ Accurate key
- ⑨ Option key
- ⑩ Data reduction key
- ⑪ Data increment key
- ⑫ Stop key
- ⑬ Unit conversion key
- ⑭ Function key
- ⑮ Start key
- ⑯ Bus/Car shift key

3.3. Putting through the power and number input



1. Turn on the power switch and start self-check inside the balancing machine. The default measurement option after self-inspection is standard dynamic balance of truck state. (It takes more than 5 seconds to restart the machine) .

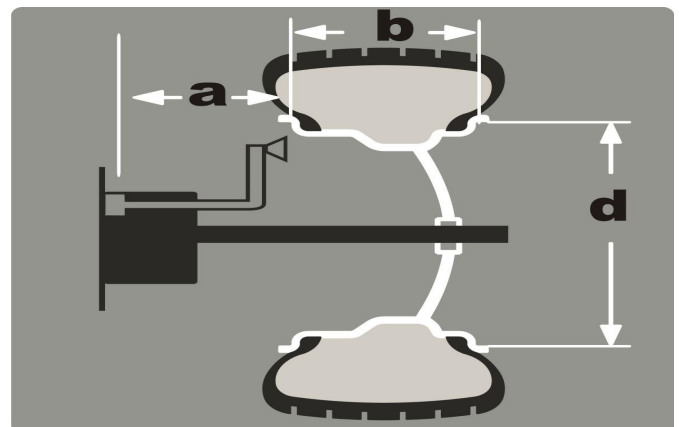
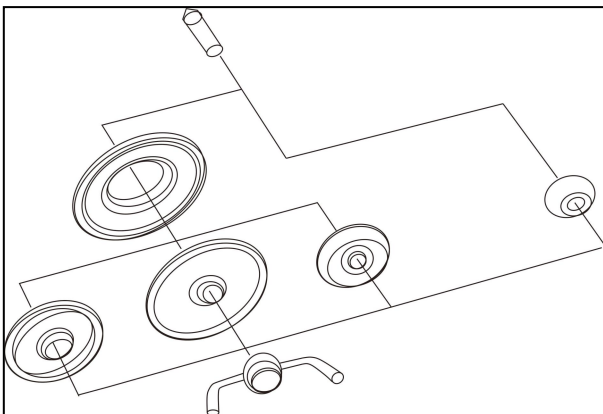

2. Wheel installation



When the wheel is installed, different clamps are selected according to the tire size, as shown in the picture:



3. Wheel data input:

Press  key and choose a, pull the ruler to the inside of the rim and install the equalizer, according to the number, press  or  key, type the actual value. This machine defaults to the common value mm.

Then press  key and select input rim width data b, measure the width of two rims with the width gauge in the accessories, press  or  key, input the width data of the caliper. This machine defaults to British Inch.

Then press  key and select data d to enter the tire diameter, Check the tire marking to confirm rim diameter and then press  or  key, input the rim diameter date. This machine defaults to British inch.

3.4. Select and change the unit

Press  key can change Gram & Ounce

3.5. Some examples about balancing

After boot, the spindle is fitted with tires to select the appropriate cone, and the release nut is locked, Input a、b、d three datas, For instance: as picture

1. Press  key, 8 seconds later, automatic brake shows as picture:

 is add lead lump value inside tire

 is add lead lump value outside tire



2. Rotate wheel to make inside indicator lamp be on and vertical over the main shaft, strike 145g lead lump on wheel steel (as picture)

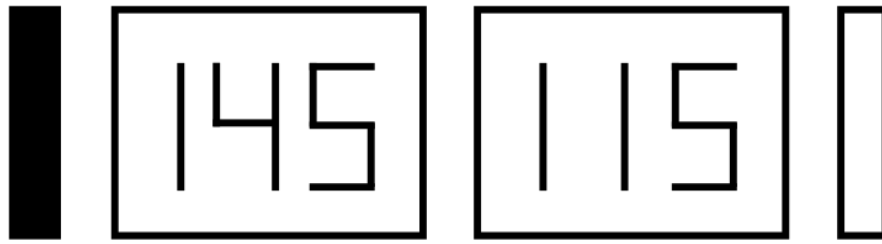

3. Then rotate wheel to make outside indicator lamp be on and vertical over the main shaft, take away 115g lead lump from wheel steel (as picture)



4. At this time outside indicator also indicates 0, balance is over, unload the tire . if you test the tire again, you needn't switch off power

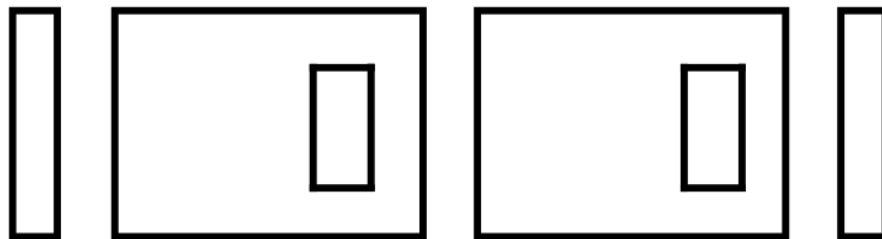

3.6. Options for mode of balancing(Press F key to select)

According to wheel material and rim structure , choose the following balance mode to press F key in succession and can show the balance mode that rim needs for different structure and material

1. Static balance: revision is adopted when balance lump can't added on wheels both sides of rim

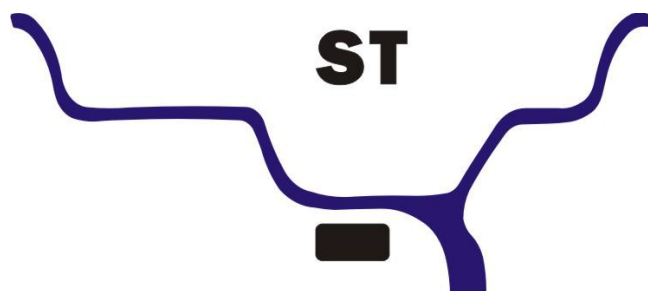

2. ALU1-Balance the light-alloy rim, adopt a way of adhering balance lump on the two shoulders in the rim

$$A1=A+3/4''$$

$$A2=A+b-3/4''$$

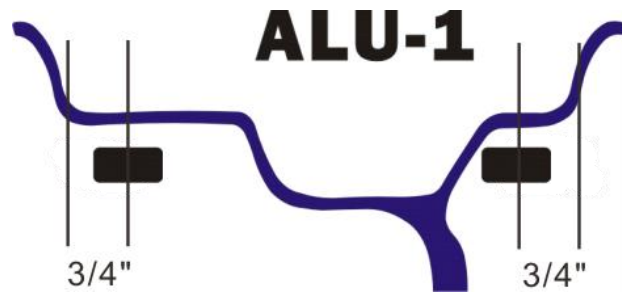

3. ALU2-Balance the light-alloy rim, adopt a way of gluing balance lump hidden inside

$$A1=A+3/4''$$

$$A2=\text{Point 0 the outer distance of flange}-1/2''$$

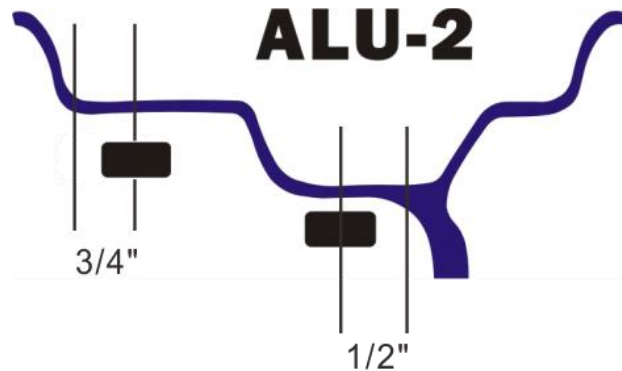

4. ALU3-Inner circle clips balance lump, outside adhere to balance lump

$$A1=A$$

$$A2=\text{Point 0 the outer distance of flange}-1/2''$$

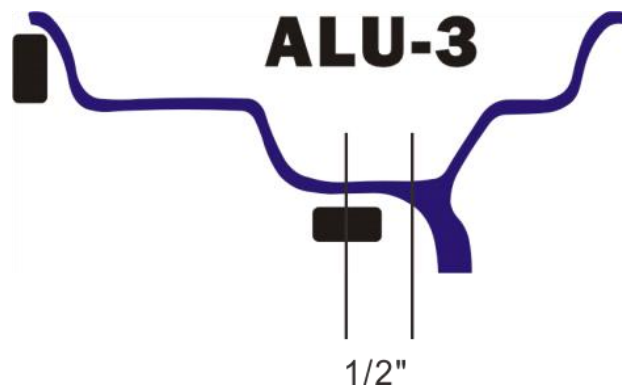

3.7. Precautions in the process of use

Attention:

- When power starts, push the wheel by hands to assist starting which will extend motor's life. Due to balance angle error, please find out by yourself when this machine rotates wheel to find balance point, pay attention which direction is much more accurate when wheel turns inward or outward.
- As the balance is over, unload the tire, pay attention to handling with care, don't strike the main shaft.
- While assisting braking, by the time when the display board has data to show, then can step on the pedal brake at the lower right corner of the machine, otherwise diminish the life-span of the machine.

3.8. Balancing experiences:

1. As indicated data is less than 50g, lead lump can be struck at the same time on both sides
2. When number is greater than 50g, producer proposes to balance one side after another, namely one side which balance number is greater is balanced to reach "00" and then another side is balanced to reach "00".
3. When there is still a small remaining part of lead lump after striking lead lump, it is because there is a error of lead lump position, it can be solved through moving lead lump to direction where there is space.
4. After "00"- "00" occur, 5,6,7g will occur also by accident, it is thought to normal phenomenon. Precision of this machine is 5g namely it is zero below 4g. Allowed change scope of this machine is 3g, 7g error will indicate by accident, it will not affect balancing effect of this machine.
5. When appearing incorrectly or repeatedly strike but not reach 00, you can self correct the machine (please see the next page for re-storation of standard process)

 **Comments:** This experience is only for reference. Hope user can grasp machine performance skillfully for better use.



4. Self-calibration (Car and truck tires need to be corrected separately)

Self correction has been finished in the factory. If you use for many years and change part or doubt balance to be a big error, you can self correct it again. (Choose one medium-sized tire to install on main shaft, unevenness of steel rim on both sides of wheel is relatively slight)

⚠ Warning: When going self calibration, Make sure that the wheel is required to be plentiful air, Remove dirt or impurities from the tires, The balancer must be stable

1. Input correct number of this tire A, b, d.

⚠ Attention: Incorrect input of size will lead to that machine can't correctly determine caliber so following measurement will have errors.

2. at the same time press  and  keys, A few seconds later, display window show **CAL**

3. press  key show **Add 0**, press **START** key, after the machine stops running show **Add 100**, push the wheel, just above the outside position, (When the leaded position indicator lights are all on), add 100g standard lead lump

4. then press **START** key, after the machine stops running show **100 Add**, Remove the 100g rectified lead block from the outside, directly above the inner side position (When the leaded position indicator lights are all on)

5. then press **START** key, after the machine stops running show **END CAL**, self calibration is ending.

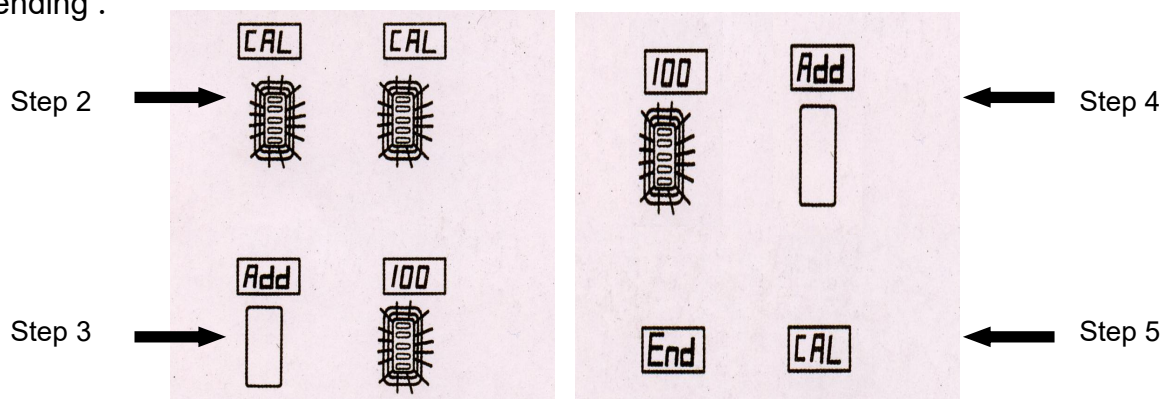

Two key elements to judge if self correction is accurate

1. Accurate number indication

2. Show that phase is right (namely outside indicator lamps are all on and 100g lead lump is rightly under shaft.)

Problems that occur after self correction:

1. Number indicated is ok, but phase is inaccurate, deviation is very great.

Trouble: don't reduce after finishing striking the lead lump, usually the store device is damaged . Change it.

2. Showing ERR (this machine screen shows Err. -8-)

A .Problems with computer board.

B .The circuit of sensor is broken.

3. Number indicated has a big deviation, namely within 10g. (not affect using)

A. Generally use lead lump of 100g inaccurately.

B. The edge outside wheel rim is irregular, can take down the lead lump and strike lead lump again on the opposite side and make comparison through drawing 2 times average.

4. Self correction can't be done because of different practices, fingers can slightly give a push. Time difference between two fingers is half a second.



5. Number indicated deviates a lot , changed number is still very big , generally because the board damage of the computer or the sensor is problematic.





5. Function setting

Press  key in 5 seconds , access to the following feature settings:



















—p— Protection cover setting

b1p On the top operation, then press  key , press  confirm to set B1p.
electric whistle ON、 OFF, press  key confirm .

APP On the top operation, press  key, press  key confirm to set APP.
Press  key,set 1g or 5g, press  key confirm

P.C Protection cover control function setting.on the top operation, press  key, press  key confirm to set P.C. press  key to set ON/OFF, press  key confirm.
Press Stop key to exit function settings(**Option, without include**)

6.Balancing machine self-testing function

Press  and  key , A few seconds later, display window show  ,
press  key , A few seconds later, display window show   . Then press  key, show   . To push the wheel forward or backward, from  to  repeated change, it shows that the photoelectric sensor works normally.Then press  Key, show   , To press the balance shaft by hand, Digital change, It shows that the vertical sensor assembly is normal. Then press  key, Show   ,
To press the balance shaft by hand, Digital change, It shows that the horizontal sensor assembly is normal. Press Stop key to end self-testing.

7.Common failure codes and solutions

Err—1— No counting signal, replace the computer and photo electricity board

Err—2— The test speed is not enough, the spindle does not rotate the wheel

Err—3— Big Measurement error, cannot calculate, replace the wheel and test again

Err—4— Detection of reverse, replace the photoelectric board or computer board, three phase electric phase modulation













Err—5— Choose the function of protective cover correctly

Err—6— The code is not set

Err—7— Incorrect correction, re-calibration

Err—8— Uninitialized, need correction

Prompt:

1. When using a balancing machine without a tire protective cover, press the start key, if the display window shows -ERR-5-, indicates that the balancing machine is in a self-locking state, unlock it before working normally. Method are as follows: Press  key for 5 seconds, display   , press  , display   , press  or  key, display   , then press  unlock function, press  to eliminate. The balancer will lock itself immediately if it is subject to external interference (such as electromagnetic interference), achieve self – protection.
2. No error display during measurement, such as display 0 0 (0.00 0.00) , Re-calibrate can be solve this problem.
3. If any key does not work (the machine is not working).Turn off the power and restart it.

8. Accessories accompanying machines.

A set of balancing machine and name of all accessories

1. one lead screw connecting with main shaft	5. five cones, (scope is 45mm-280mm)
2. one plastic calliper	6. one handle
3. one bags of lead lump	7. one center wheel
4. one balance pincers	8. two matching machine outside shaft



EXPLODED DRAWINGS

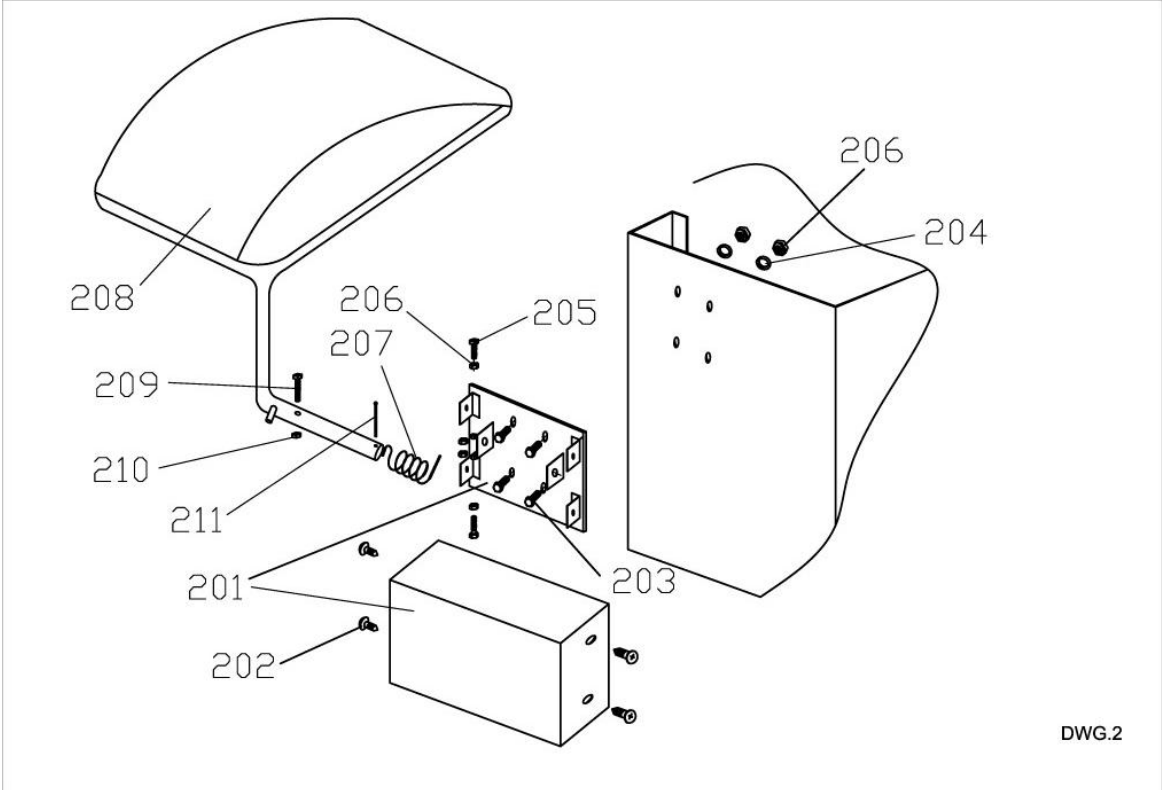
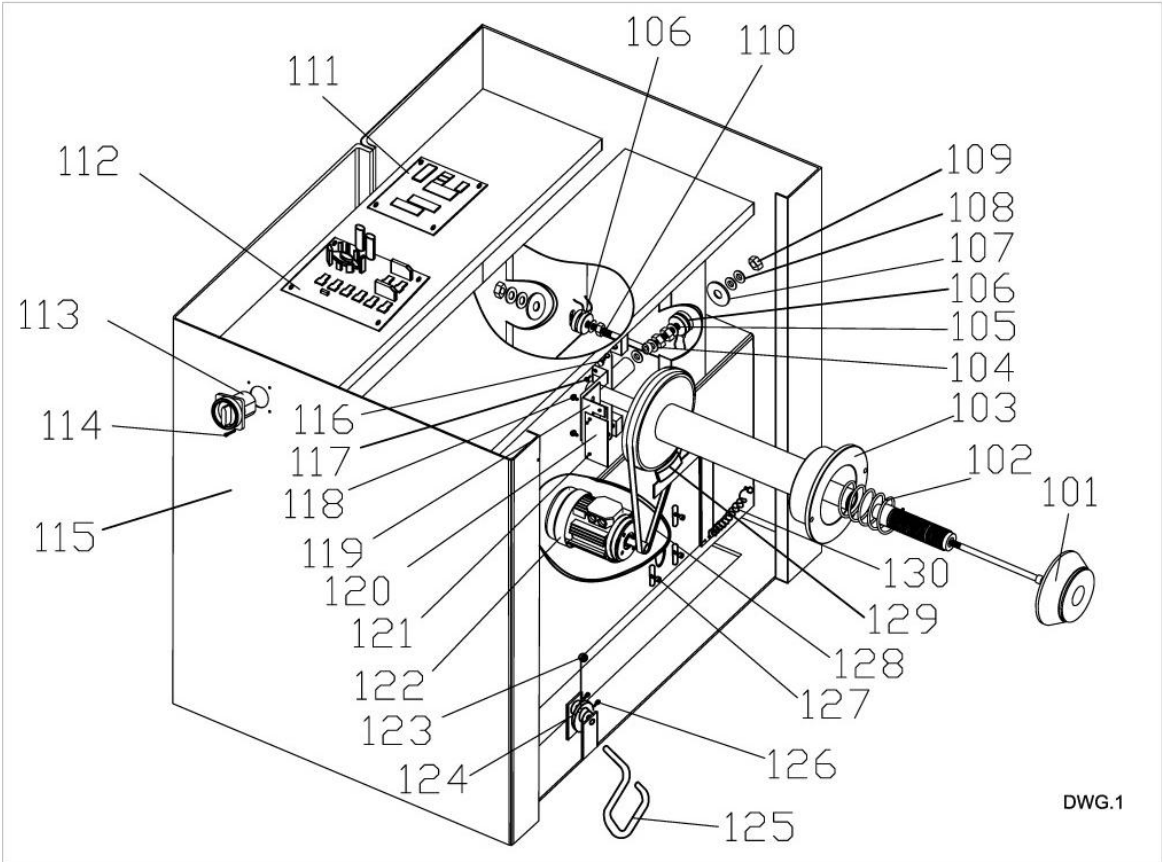

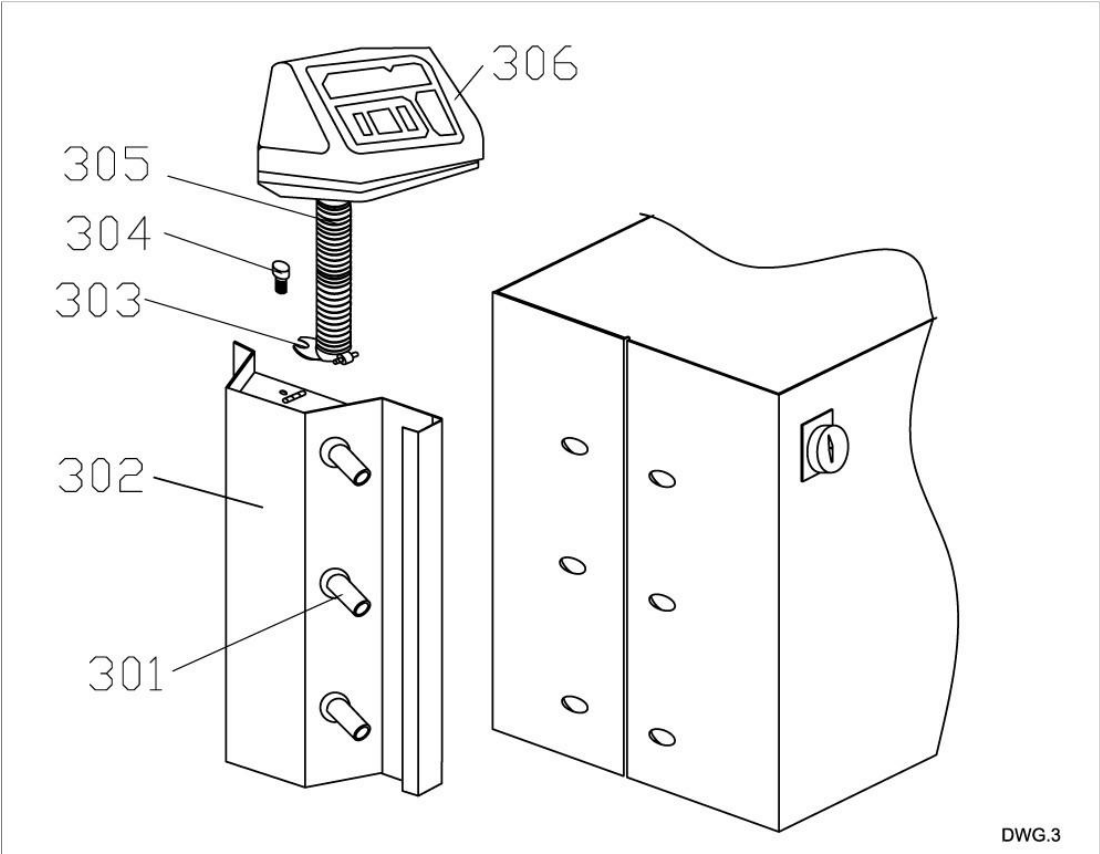

DWG.3

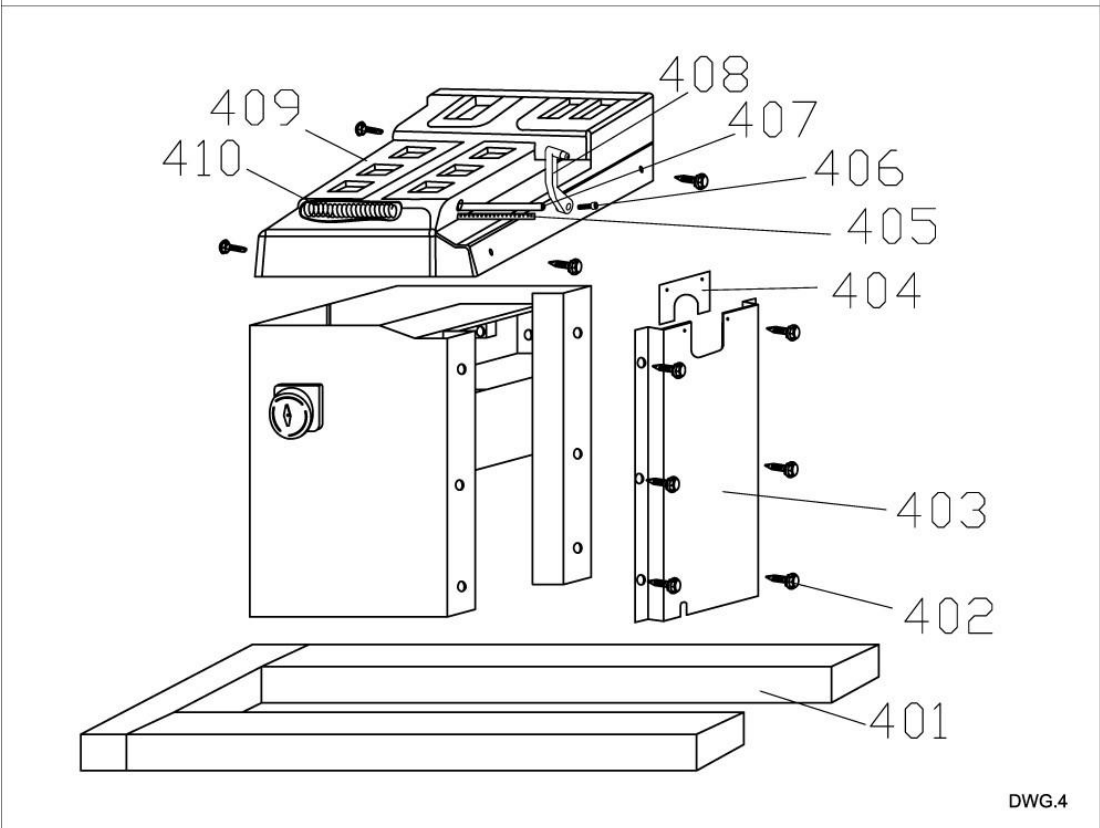

DWG.4

