

40' X 80' FT PEAK CEILING STORAGE SHELTER

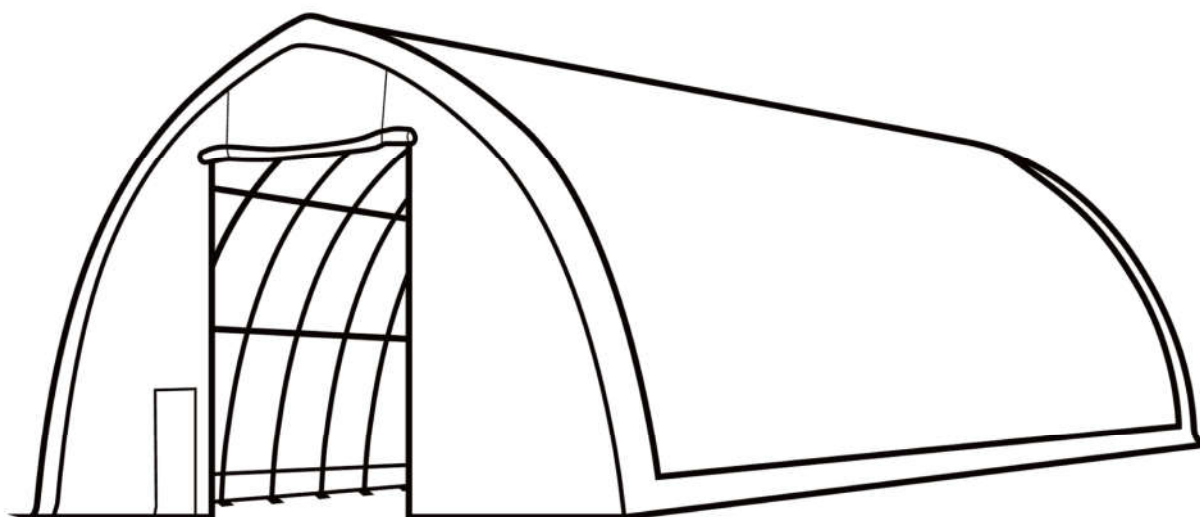

⚠ WARNING



- Please read and understand the product manual completely before assembly
- Check against the parts list to make sure all parts are received
- Wear proper safety goggles or other protective gears while in assembly
- Do not return the product to dealer. They are not equipped to handle your requests.

Missing parts or have questions on assembly?

Please call: 1-877-761-2819 or email: cs@tmgindustrial.com

MAIN SPECIFICATIONS:

- Overall assembled size : W12 x L24 x H6.7(m) / 39.4 x 78.7 x 22(ft)
- Front and back roll up door : W4.08 x H4.87(m) / 13.4 x 16(ft)

CONCRETE FOUNDATION SIZE SEE BELOW FIGURE.

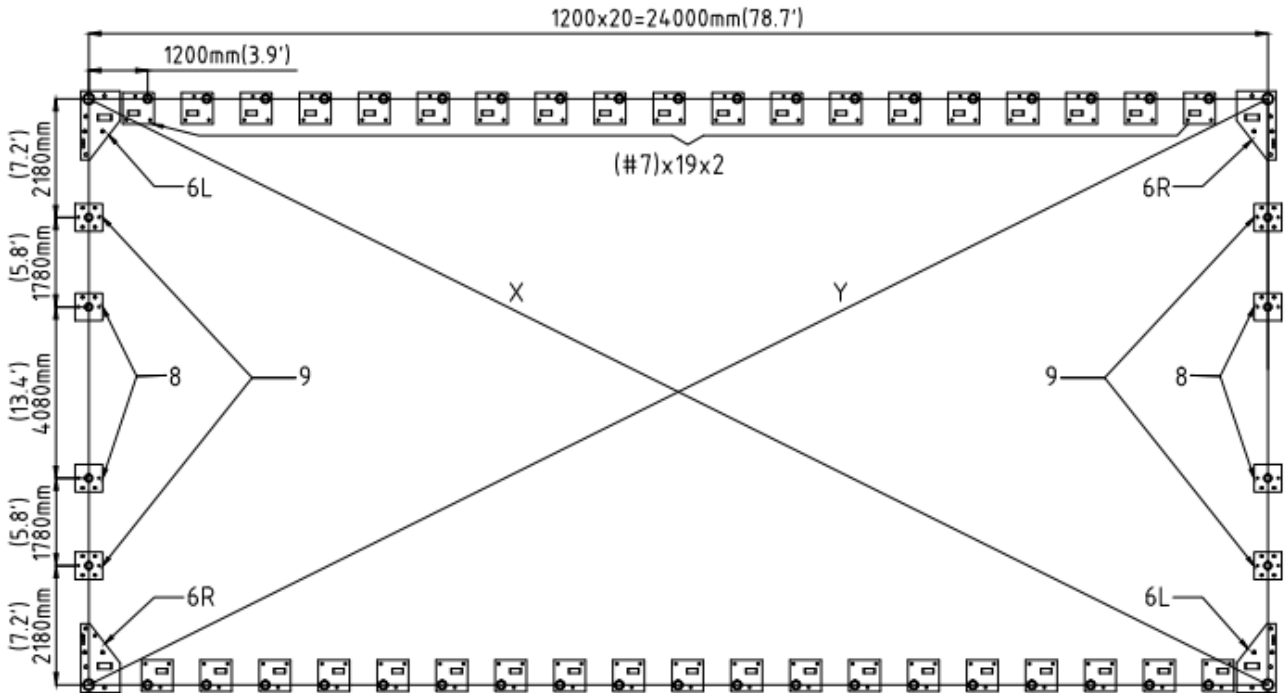

PRIOR TO ASSEMBLY

Please read the instructions carefully before installation. It is important to follow your local safety regulations and industry standards during installation. Regulations may include but are not limited to:

- Safety helmets, protective eyewear, and clothing
- Safety harnesses for all elevated workers
- Proper ladder, cage, and safety operation













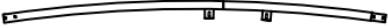



Check all components and parts before installation. All parts are marked with a part number, please refer to the parts list to make sure you have all parts.



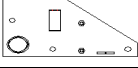
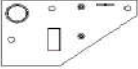











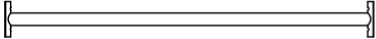
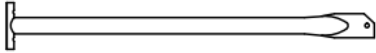

Choose a day with low or no wind to install, assembly is hard in heavy wind. Do not make any alterations to the structure. Do not hang any weights on the frame during installation, including parts. We are not responsible for any damages or injuries caused by inappropriate installation, unauthorized modifications or extreme weather.







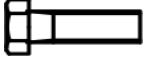
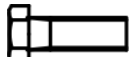
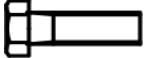
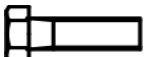





This building is not intended for human occupancy.

It is recommended to tape or add foam/rubber on the frame where joints connect and where it touches the cover. This will help extend the life span of the cover.

TMG-ST4081V PART LIST

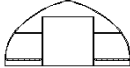
PARTS CODE	GRAPHICAL	DESCRIPTION	LENGTH	QTY
1		Peak arch tube	φ58x1935mm	21
2		Upper rafter tube (middle truss)	φ58x2672mm	38
2A		Upper rafter tube (front and rear truss)	φ58x2672mm	4
3		Sidewall tube (middle truss)	φ58x3100mm	38
3A		Sidewall tube (front and rear truss)	φ58x3100mm	4
4		Lower rafter tube	φ58x2067mm	38
4A		Lower rafter tube	φ58x2067mm	4
5		Roof Purlin (horizontal tube)	φ42x1140mm	140
5A		Support tube for roof frame (middle)	φ42x2250mm	19
5B		Support tube for roof frame (left and right)	φ42x2253mm	38
5C		Dropping tube for top roof	φ42x1156mm	38
6L		Left corner base plate (front and rear truss)	6x200x350mm	2
6R		Right corner base plate (front and rear truss)	6x200x350mm	2
7		Middle truss base plate	6x200x200mm	38
7A		Ratchet	3T	42
8		Door column base plate (front and rear truss)	6x150x200mm	4
9		Middle column base plate (front and rear truss)	6x150x200mm	4
10		Door frame lower tube (front and rear truss)	φ58x2783mm	8
10A		Door frame upper tube (front and rear truss)	φ58x3180mm	4

10B		Door frame centre upper tube (front and rear truss)	φ58x2060mm	4
11A		Rope pulley	30x35x130mm	2
11B		Rope pulley	30x35x80mm	2
12		Front and rear door crossing beam (right)	φ58x2089mm	2
12A		Front and rear door crossing beam(right)	φ58x2037mm	2
12B		Door center vertical supporting rod for cross beam	φ42x1143mm	4
13		Front and rear door upper crossing tubes (left and right)	φ42x1760mm	4
13A		Front and rear door upper crossing tubes	φ42x1470mm	4
14		Front and rear fabric panel tension tubes	φ32x1700mm,	4
14A		Front and rear fabric panel tension tubes	φ32x1990mm	4
15		Front and rear connectors	φ58/φ42	14
15A		Middle truss connectors	φ58/φ42	266
16		Mounting base	40x100mm	80
17		Sidewall frame steel tension cables	φ6x3200mm	40
18		Self locking bolt and nuts	M8x60mm	280
19		Half round head bolt	M8x80mm	372
19A		Hexagon bolt and nuts	M10x80mm	8
20		Hexagon bolt and nuts	M10x30mm	130
21		Hexagon bolt and nuts	M10x50mm	8
21A		Hexagon bolt and nuts	M8x50mm	38
21B		Self-tapping screws	#12x25mm	147

22		Steel tension cables (for #7A and front and rear arches)	W30xL800mm	42
23		Water plug	φ30mm	20
24		Braided rope	φ8x300m	1 bundle
25		Expansion bolt (not included)	φ16x150mm	142
26		Door dropping tube	φ32x1993mm φ32x2200mm	2 groups
27		Top cover tension tube (for both bottom sides)	φ32x1993mm	24
27A		Top cover tension tube (for both bottom sides)	φ32x700mm	2
28		Top cover		1
29		Front and rear cover panel		2
30		Bungee		4
31		Nylon rope	φ8x19m	4
32		Scratch resistant tape	10m	5
33		Tube clamps	(φ58)	4

INSTALLATION STEPS

STEP 1 : REVIEW THE WHOLE STRUCTURE AND CHOOSE THE PROPER INSTALLATION SITE.

Choose a solid level ground area to set up the building. Do not install in an area where the floor is soft, a wetland, cannot take the weight, or keep the building steady.

We strongly recommend to inst all the building on a concrete foundation with all expansion bolts to secure all base plates. Do not use any anchor spikes!

Watch the surroundings! Do not set up the building near any snowdrifts. The fabric cover can hold up a certain amount of falling leaves, light debris and wind resistance, however, large, fast or sharp falling items and big wind might punch or tear the fabric materials. Keep the building surroundings clear to avoid potential damages.

Be careful with power and heat sources. Do not keep heat sources near the cover. Do not expose the building to open flame.

- Review the whole frame structure diagram as shown in Figure 1, decide the roll up door position, and make sure you will have about 3 ft clearance around the building ,Diagonal line X must be equal to Y.
- Draw a rectangular square base line showing all positions of base plates and front and rear doors.
- Base plates: all base plates must be bolted firmly with expansion bolts #25. It is concrete expansion bolt M16.
- Base plate installation is as below and all base plates are required to install and tie firm on this step.

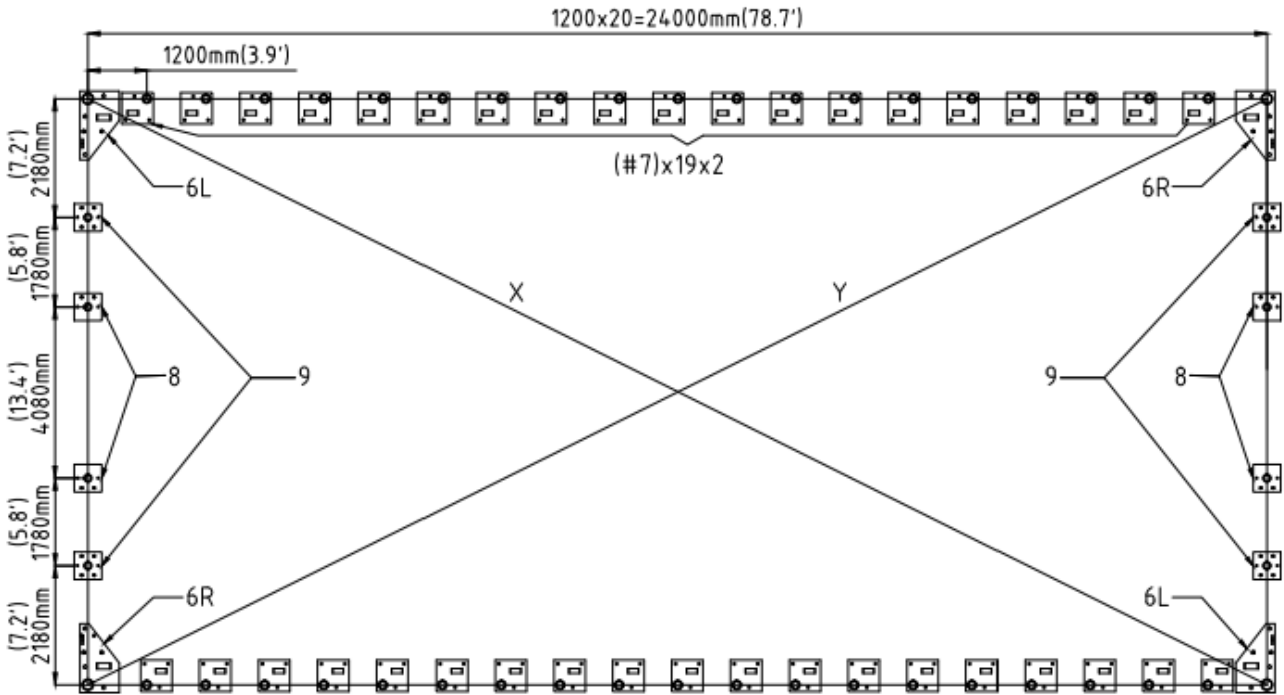

- Installation diagram of expansion bolt.

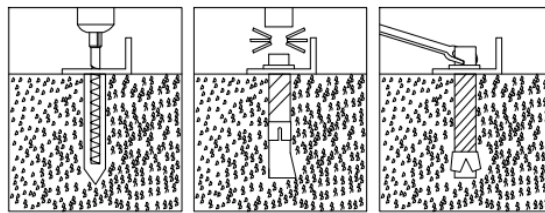

NO.	PART	QTY
6L		2
6R		2
7		38

NO.	PART	QTY
8		4
9		4
25		142

STEP 2 : ASSEMBLE ALL TRUSSES.

- The building includes 21 trusses : (1) Front truss (1st truss), (1) rear truss (21rd truss), and (19) middle trusses. The front and rear trusses are installed with the fabric panel (#29).
- Both front and rear truss include the following parts. Connect all tubes with bolt (#19).

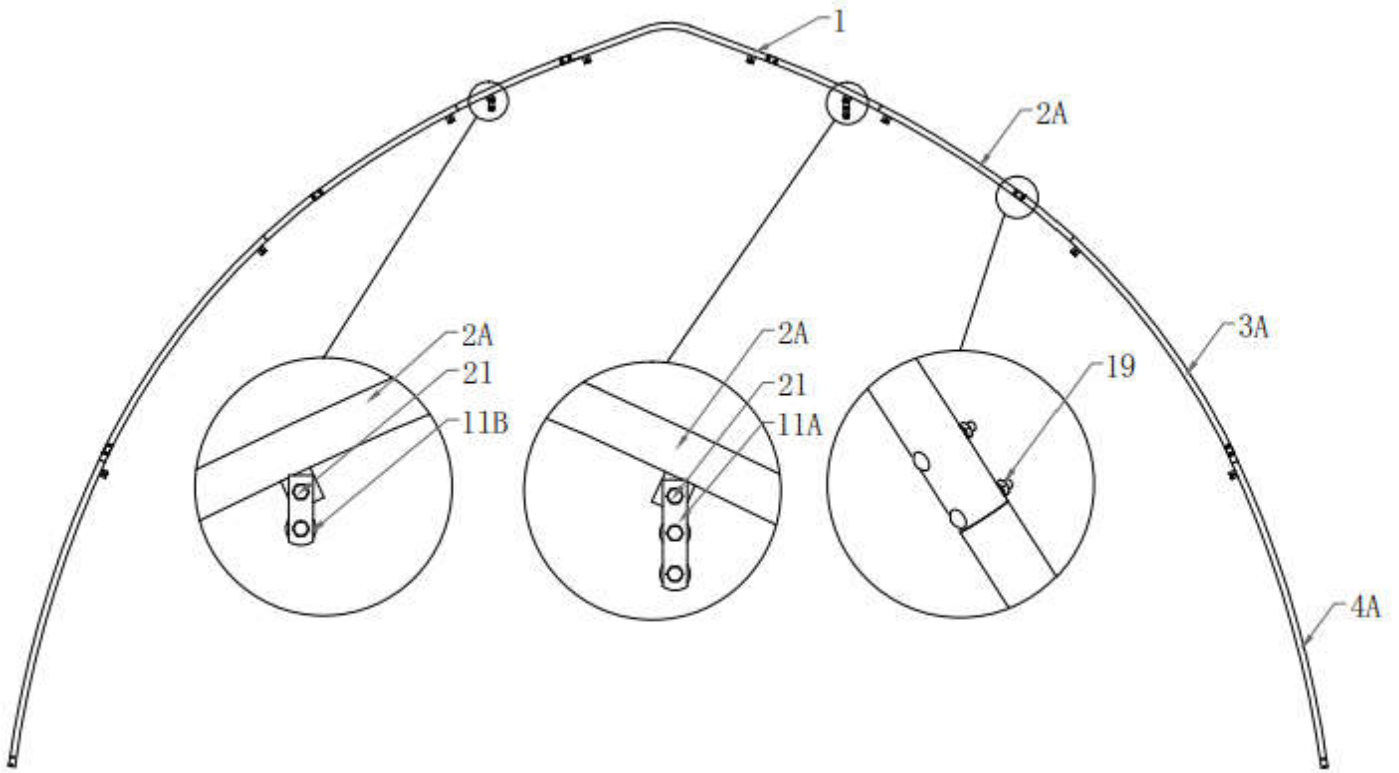

NO.	PART	QTY
1		1x2
2A		2x2
3A		2x2
4A		2x2

NO.	PART	QTY
11A		1x2
11B		1x2
19		12x2
21		2x2

- The (19) middle trusses include the following parts. Connect all tubes with bolt (#19).

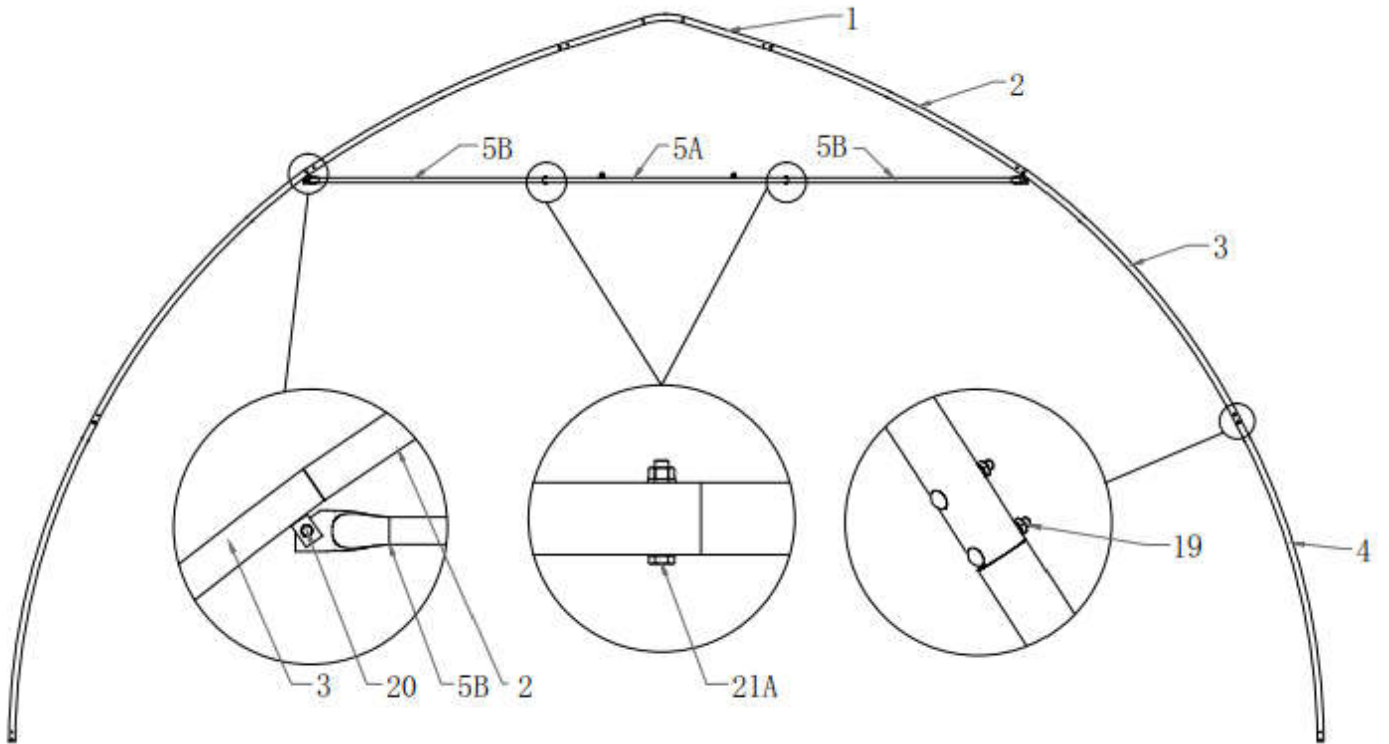

NO.	PART	QTY
1		1x19
2		2x19
3		2x19
4		2x19
5A		1x19

NO.	PART	QTY
5B		2x19
19		12x19
20		2x19
21A		2x19

- Lay down all (21) trusses on the ground as figure 4 when the assembly is all completed and before moving to next step.

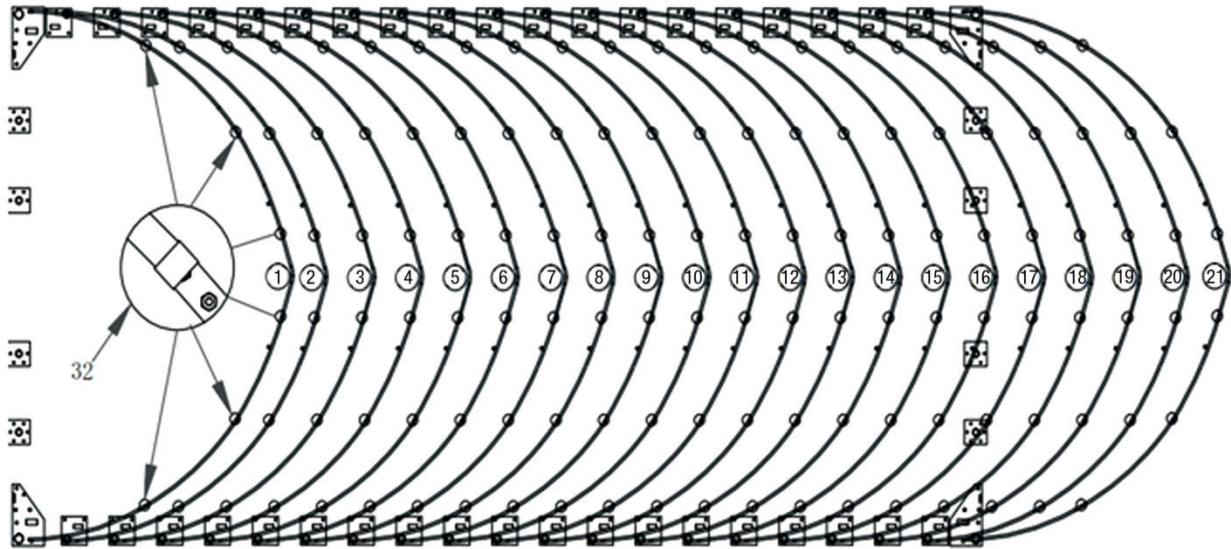

NO.	PART	QTY
32		5

STEP 3 : PUT UP THE FRONT (1ST) TRUSS.

- Use of a crane or forklift is recommended, otherwise a team can use ropes to lift the trusses, but you have to make sure it is safe, and have enough manpower. We recommend 3 to 5 people to pull the truss up from different directions. When the truss is up, tie the ropes to the heavy objects to make sure the truss will stay upright and use bolt (#19) to connect the truss to the base plate on both sides.

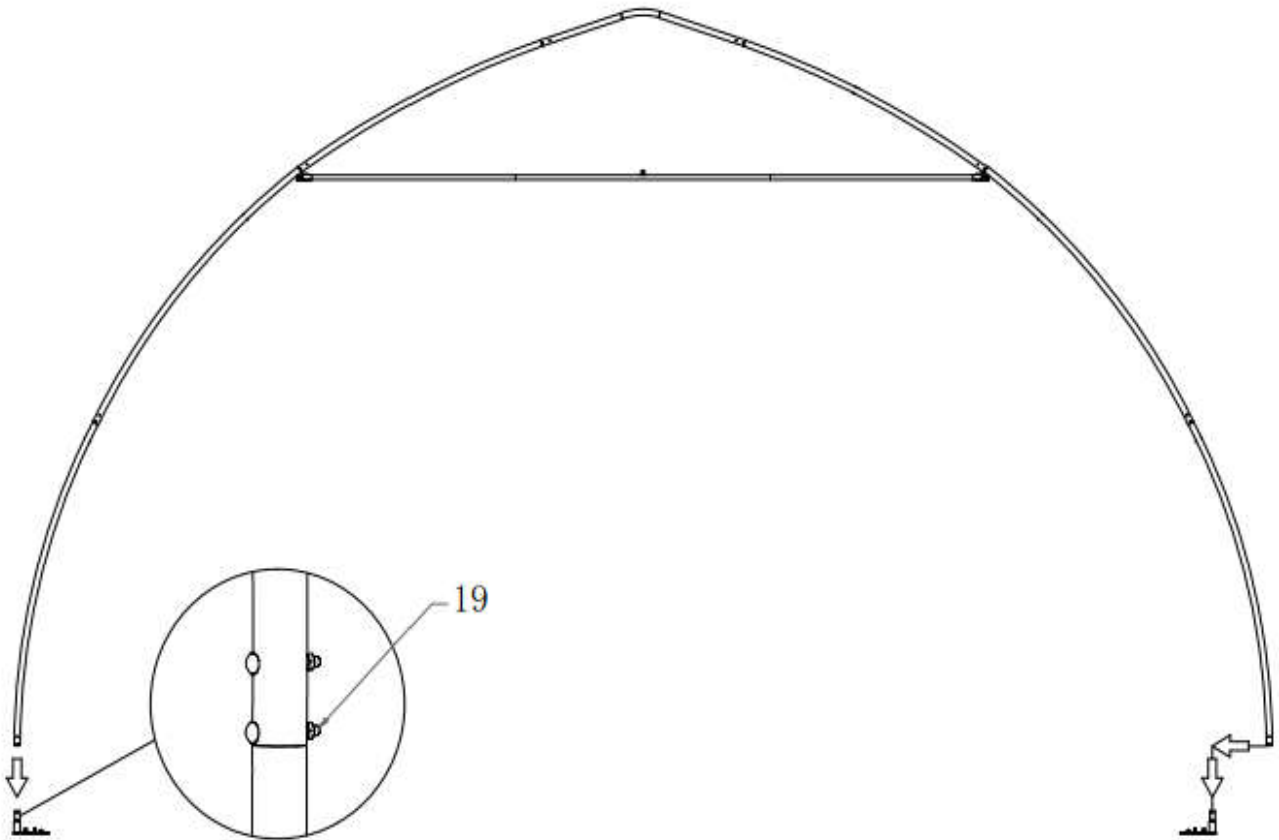

NO.	PART	QTY
19		4x21

STEP 4 : PUT UP THE REST TRUSSES.

- Refer to Step 3 to put up the rest trusses, connect all 7 purlins (#5) with bolt (#18) and secure all bolts firmly on each span before going to next truss, include the following parts .

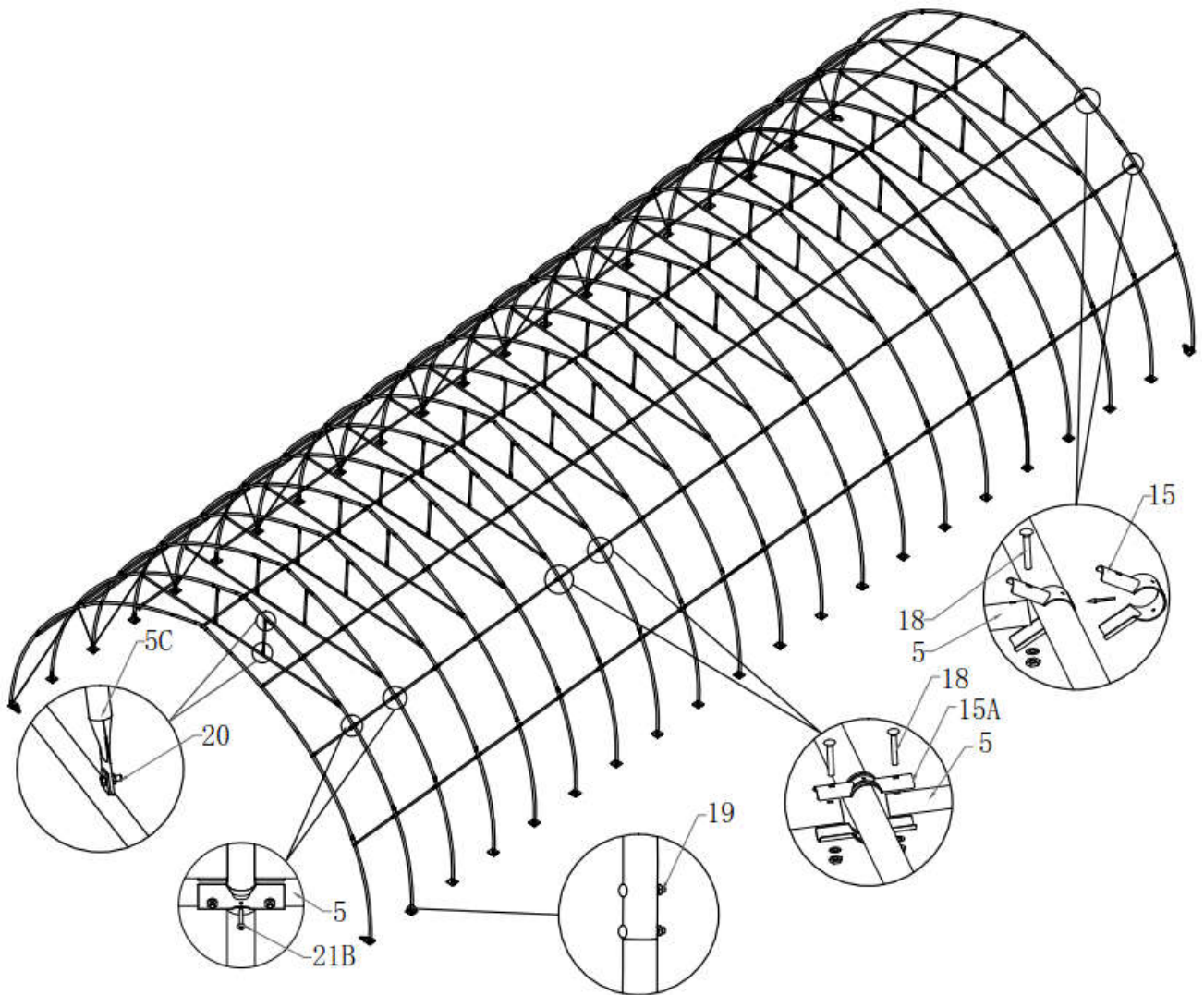



NO.	PART	QTY
5		7x20
5C		2x19
15		7x2
15A		14x19

NO.	PART	QTY
18		7x40
20		4x19
21B		7x21

STEP 5 : TENSION CABLE INSTALLATION.

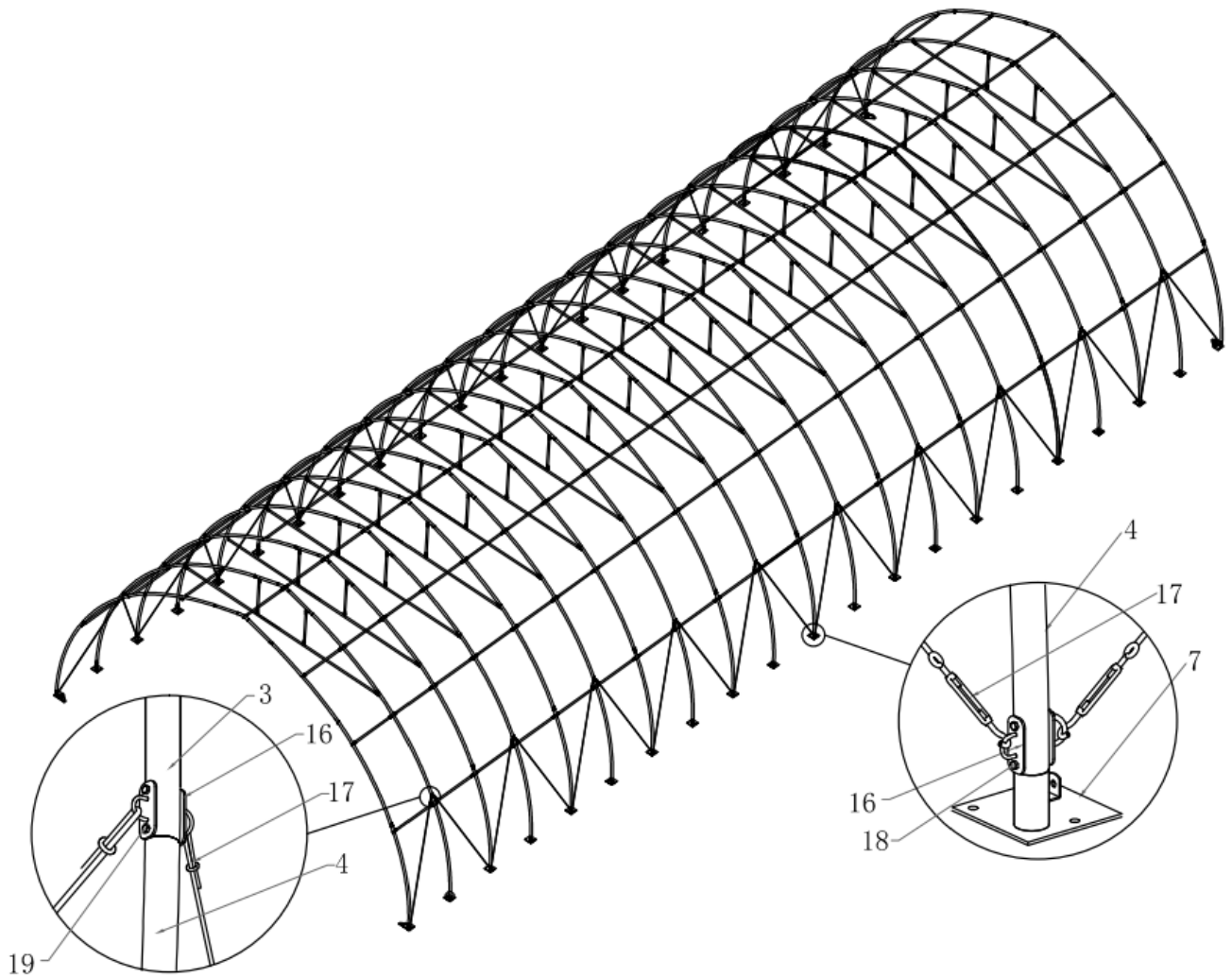
- Tension cable installation : All cables are diagonally installed on each side of the interval, total 40 cables.



NO.	PART	QTY
16		40x2
17		20x2

STEP 6 : INSTALL THE REMAINING PARTS ON THE FRONT AND REAR TRUSS.

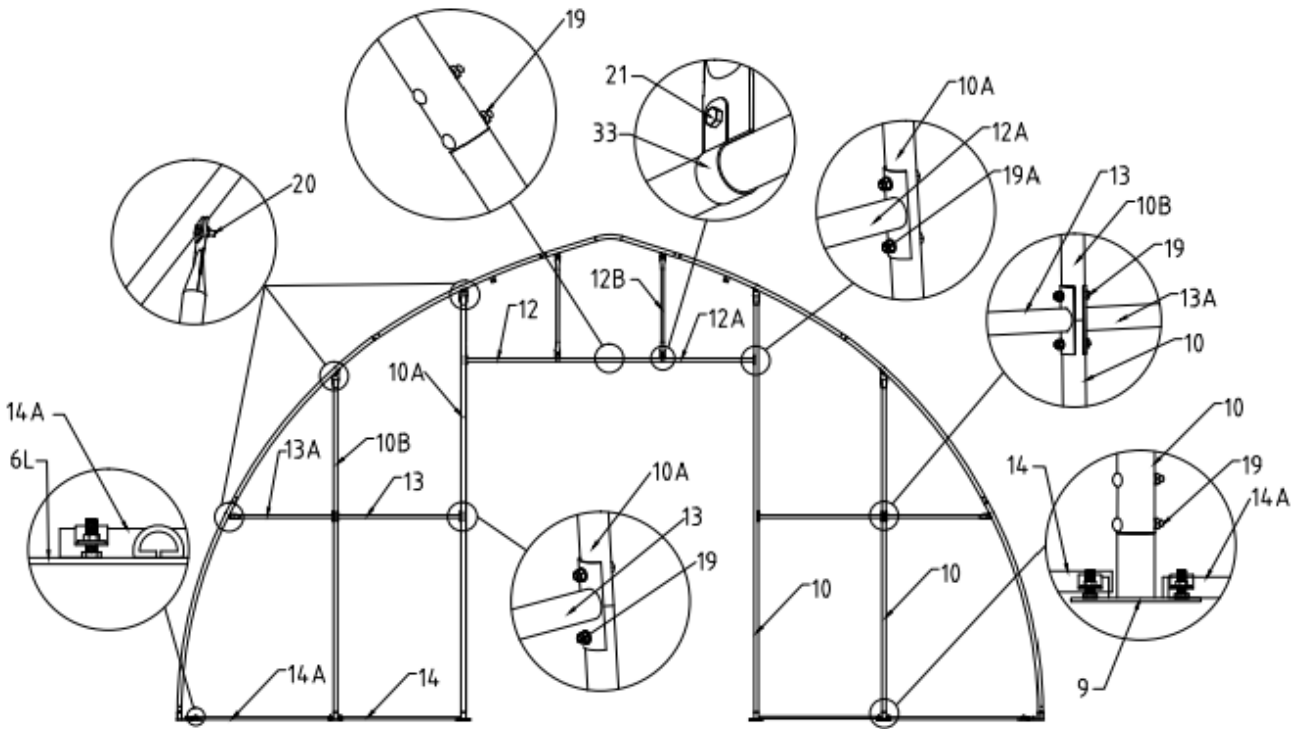





NO.	PART	QTY
10		4x2
10A		2x2
10B		2x2
12		1x2
12A		1x2
12B		2x2
13		2x2
13A		2x2

NO.	PART	QTY
14		2x2
14A		2x2
19		18x2
19A		4x2
20		8x2
21		2x2
33		2x2

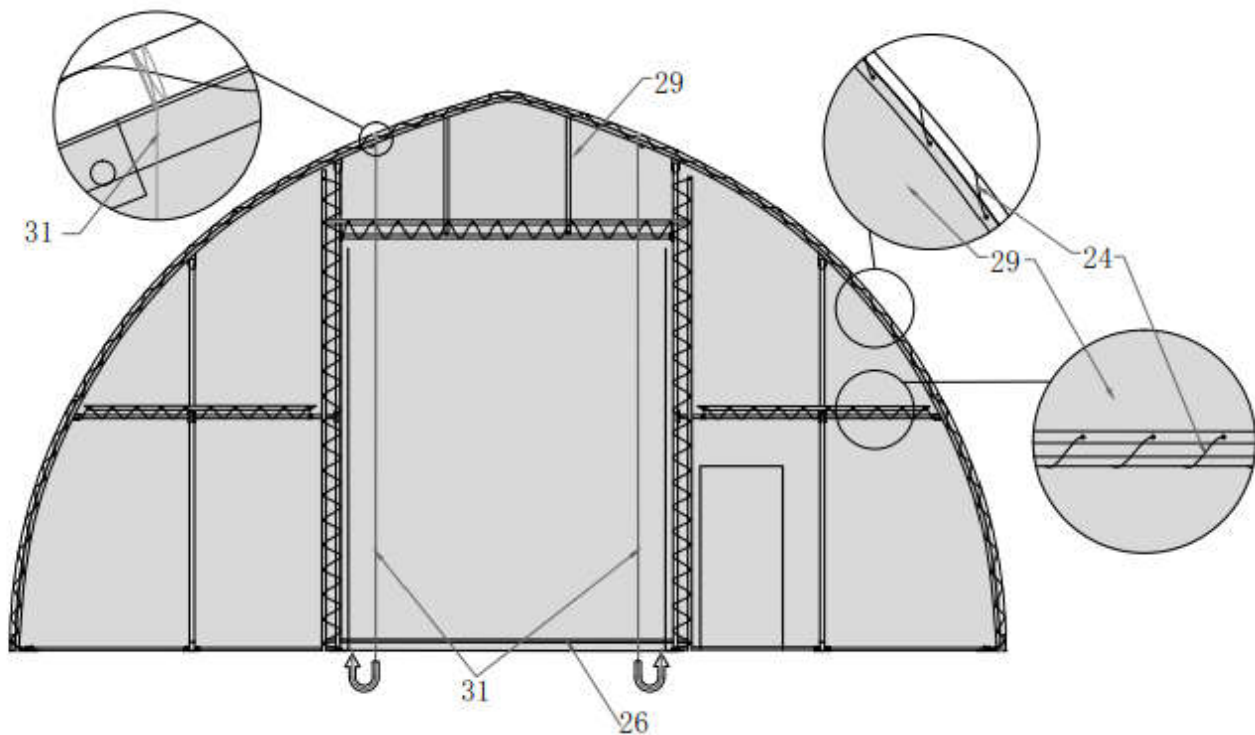
STEP 7 : INSTALL FRONT AND REAR COVER PANEL.

- The door cover must be zipped. Use rope (#24) to lift up the front cover (#29) from the center grommet and tie it firm to the truss tube and spread toward both sides through each grommet along the tube. Refer to Figure 9 and 10 on how to attach the rope and tie to the tube.
- Insert the dropping tube (#14) into the bottom groove pocket on the door cover. Tie two ropes (#31) separately on both sides of the peak arch tube. Pull both ropes under through the bottom of the door cover from the back, then go up from front and through both pulley 11A and 11B.

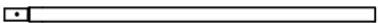
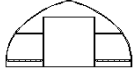

NO.	PART	QTY
24		1x1
26		1x2
29		1x2
31		2x2

- The rope coming out from pulley 11B must go through the upper wheel of pulley 11A, then pull both ropes together slowly and start to lift the door cover.
- Tie both ropes to the corner base plate. Now the door cover is up. When you drop down the door cover, do not let go too quick, otherwise it might get stuck and damage the fabric.

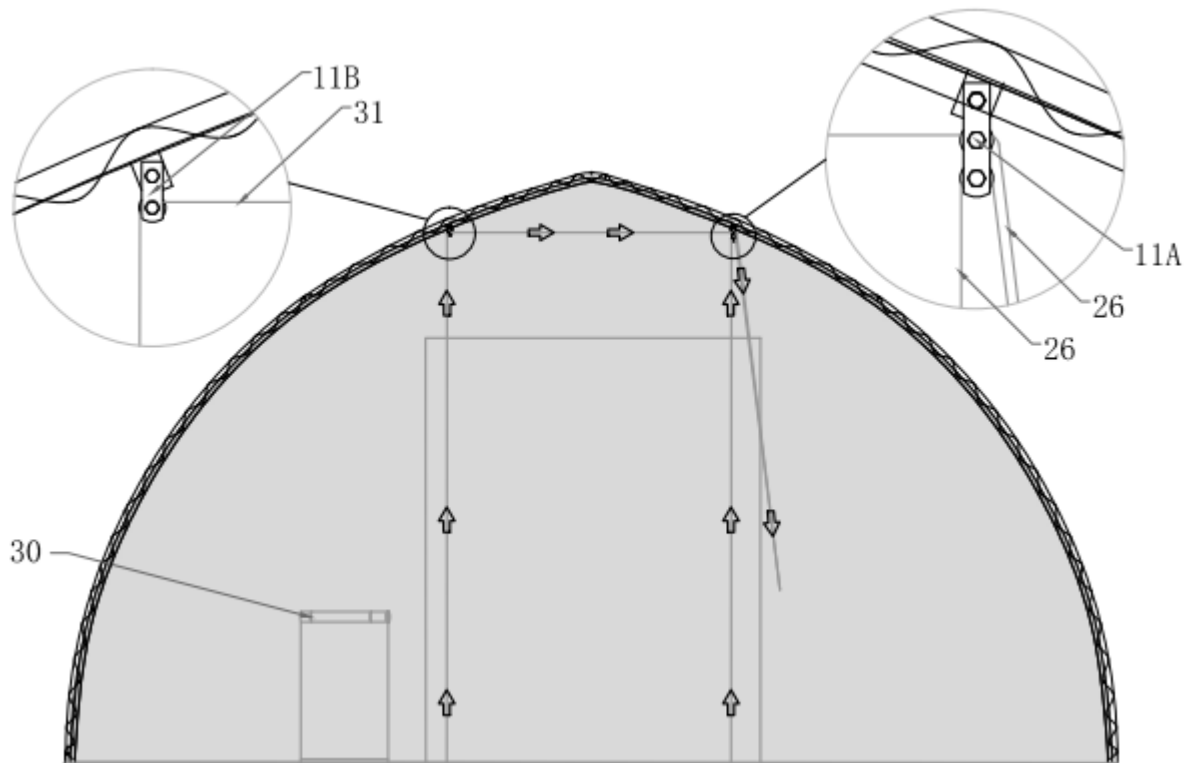

STEP 8 : INSTALL THE TOP COVER.

Do not install the cover during windy weather!

- Unpack the top cover and place it along one of the long sides of the structure.
- Use 3 to 5 ropes to top cover (#28) pull the cover over the top of the structure, 2 or 3 people standing inside on ladders to push upwards will help to move the cover smooth without any damage.

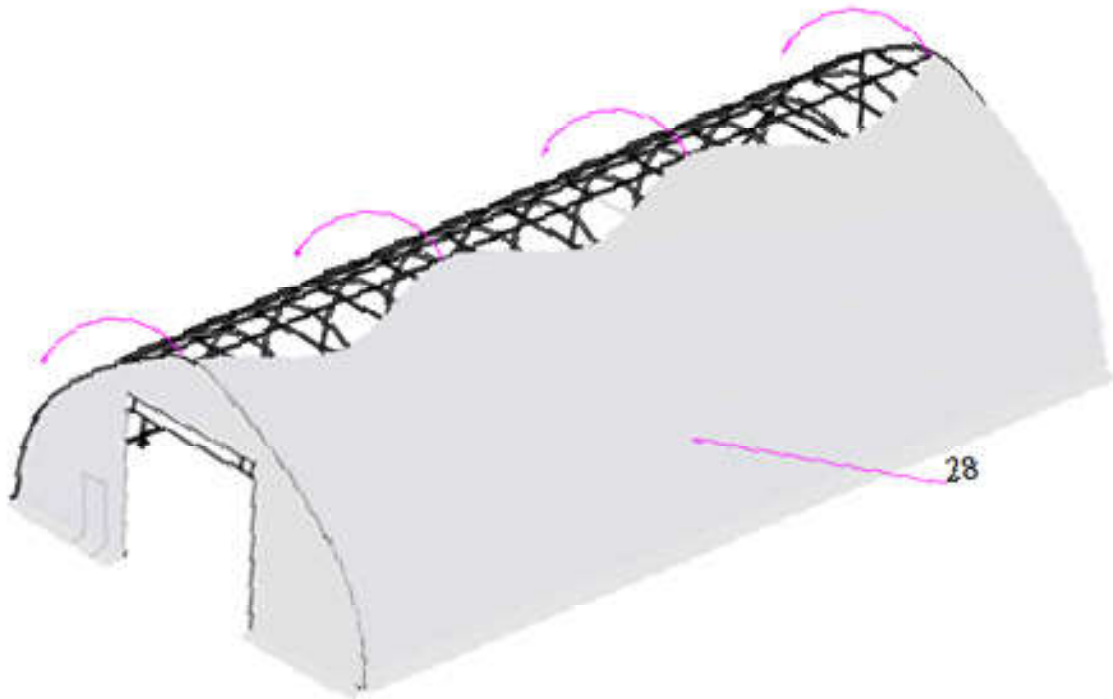

NO.	PART	QTY
28		1

STEP 9 : STRETCH AND TIGHTEN TOP COVER.

- The roof cover must be stretched and tied to the front and rear truss by rope going through the flap grommets on the cover. Start from the top center and go toward both side on each end. Add or cut the rope as needed.
- Pull and stretch the cover enough only to take wrinkles out. Repeat for the rear truss. Do not over stretch as it could rip off the grommets.

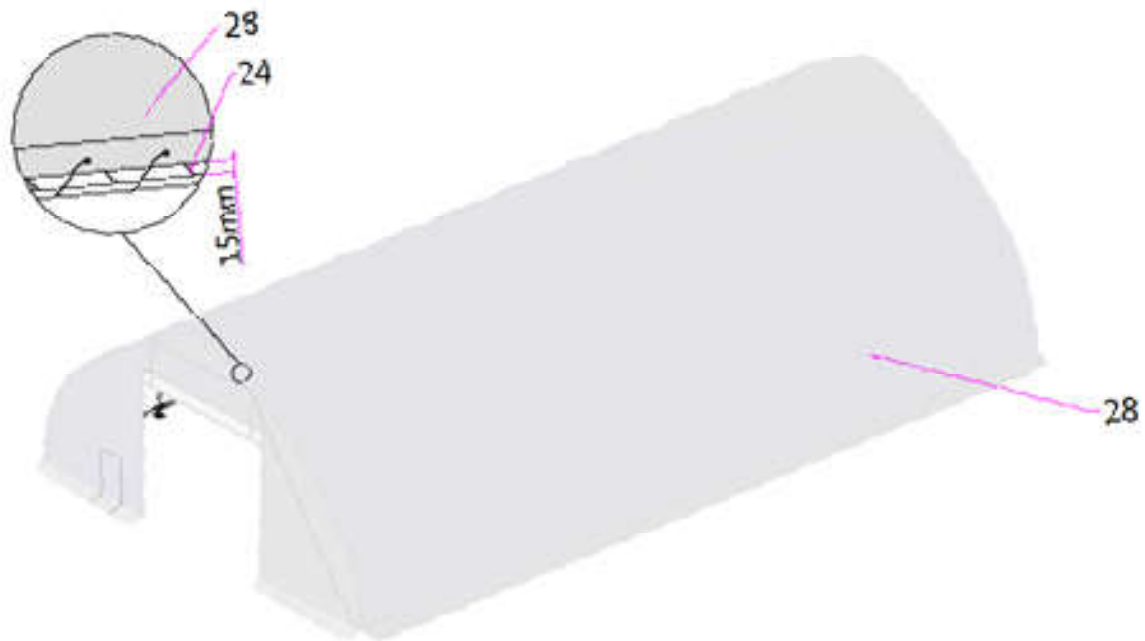



NO.	PART	QTY
24		1

STEP 10 : TENSION THE COVER ON THE STRUCTURE FROM BOTH SIDES.

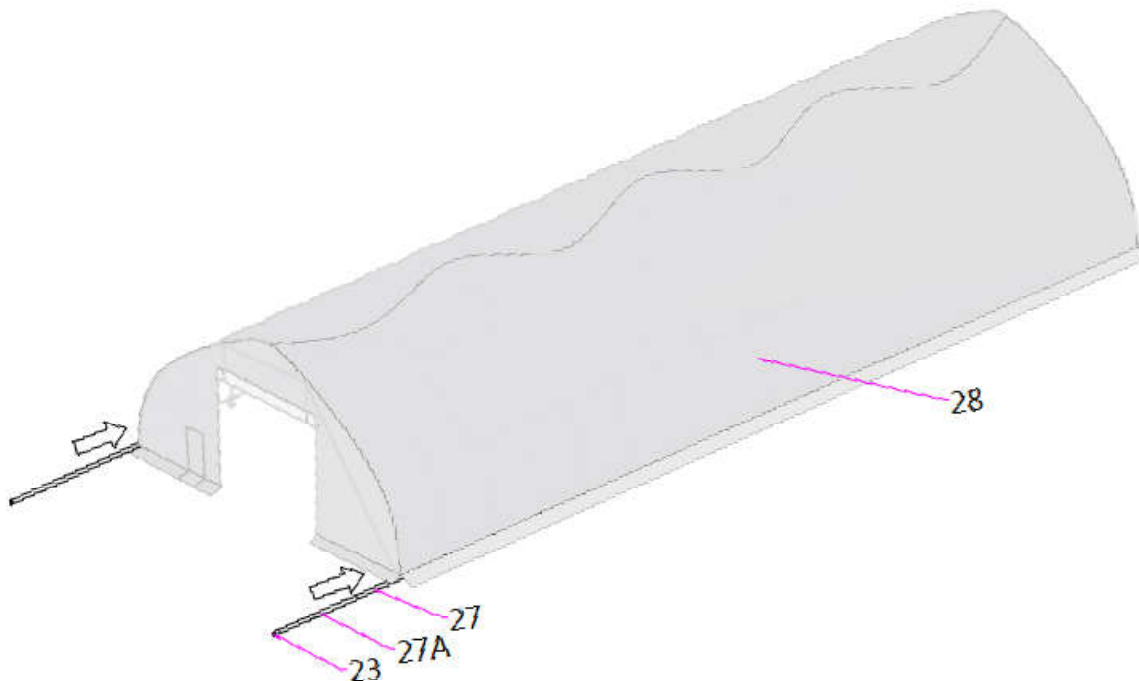
- Insert tension tubes (#27) slowly into the bottom groove pocket on both long sides. Add the water plug (#23) on the first tension tube to avoid tearing the fabric and add one to the end of last tube (#27A) as well.
- Repeat the same step for the other side.





NO.	PART	QTY
23		2x2
27		12x2
27A		1x2

STEP 11 : INSTALL RATCHET STRAPS.

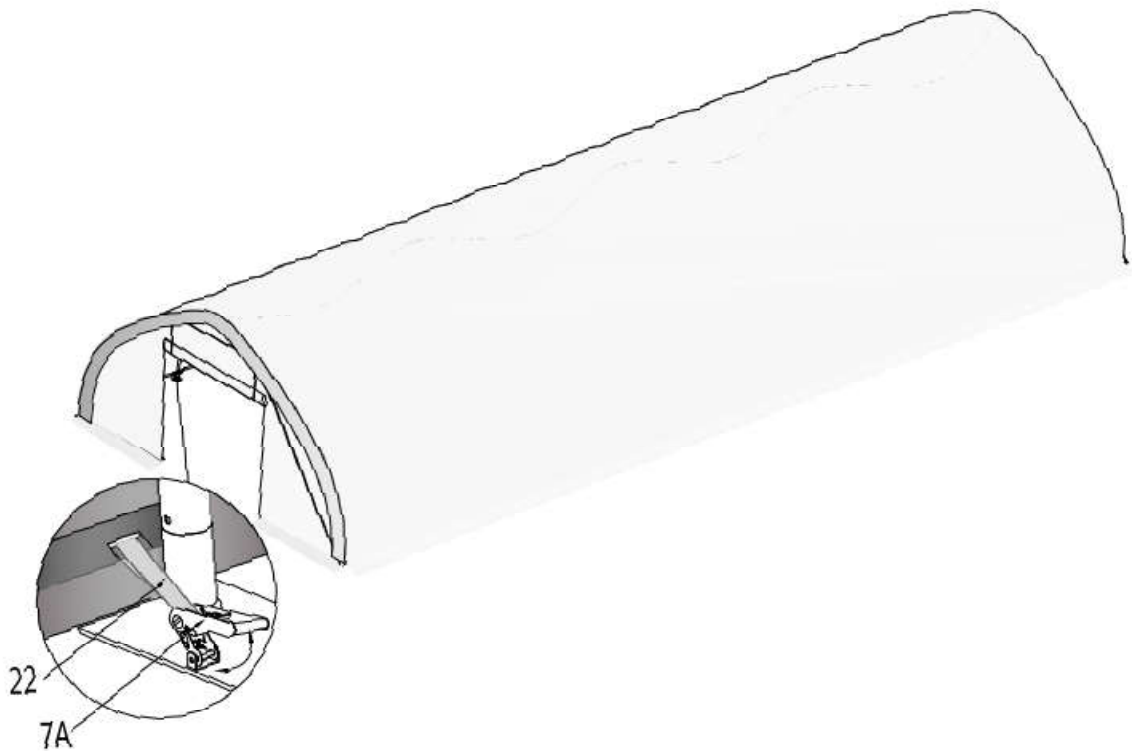
- Stretch and adjust the cover from left and right, back and forth, to make sure it is square and centered. Cut the groove pocket where it aligns with ratchet (#7A), and use strap (#22) to pull tension tube (#27) toward the ratchet and secure it.
- Evenly adjust all ratchets on both sides to take wrinkles out and make the cover flat and smooth.



NO.	PART	QTY
7A		21x2
22		21x2

AFTER THE INSTALLATION

Walk around and inspect the shelter periodically to make sure all components are still firmly secured and the whole shelter is well supported. Check all bolts and nuts as well as all connection points to make sure they are all in good position. Check the base plates, adjust the ropes and tie downs if required and clean the cover regularly.

Snow accumulating on the fabric cover must be removed as soon as possible. If snow becomes solid ice on the cover, it will increase the weight on the roof and may collapse the shelter or reduce the life span.

Keep the shelter on a dry ground most of the time. Do not keep the fabric dirt skirt under water all the time, otherwise the fabric will deteriorate.

We strongly recommend you remove any snow from the roof immediately. Do not leave any snow load on the roof overnight. Keep 3 feet of clearance on all sides at all times. Do not allow snow to accumulate and pile up on the sides of the building. Otherwise the pressure from the sides will push inwards and could lead to a collapse.