

MODEL TMG-ST3041CE

30' x 40' PE FABRIC PRO SERIES CONTAINER PEAK ROOF SHELTER

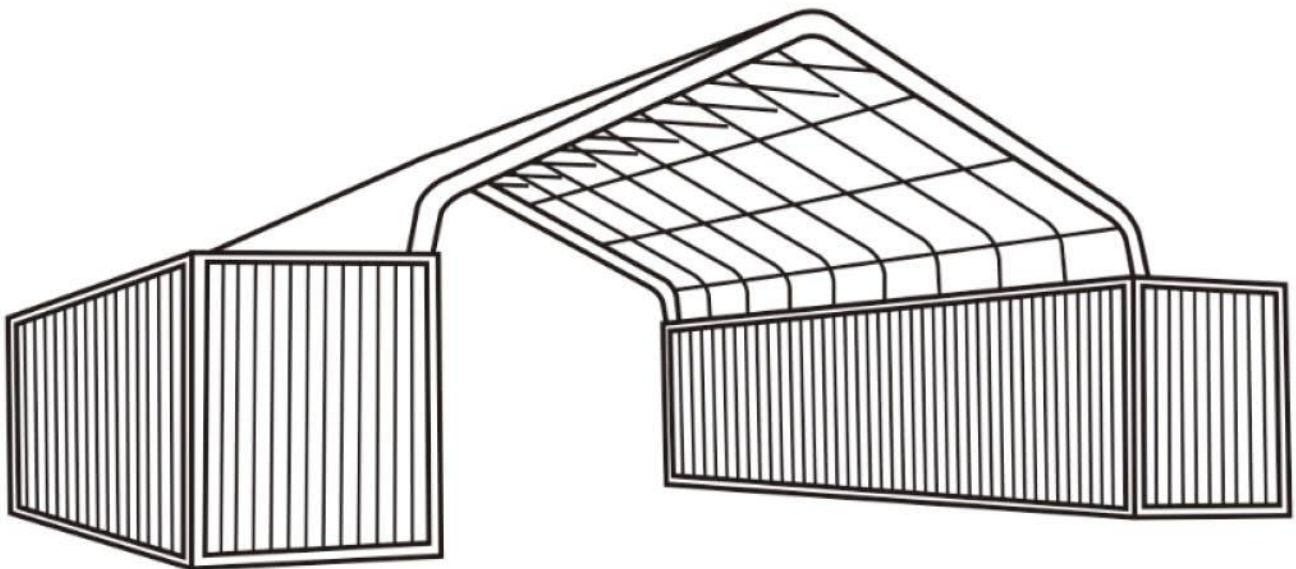

⚠ WARNING

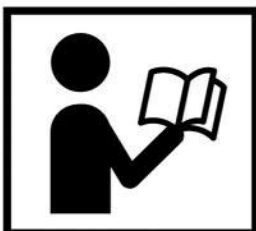

- Please read and understand the product manual completely before assembly
- Check against the parts list to make sure all parts are received
- Wear proper safety goggles or other protective gears while in assembly
- Do not return the product to dealer. They are not equipped to handle your requests.

Missing parts or have questions on assembly?

Please call: 1-877-761-2819 or email: cs@tmgindustrial.com

Main Specifications :

- Overall assembled size : W9.15 x L11.97 x H3.0 (m) / 30 x 39.27 x 9.84(ft)
- Ridge Peak Height : 3 m / 9.84ft + container height

Prior to assembly

Please read the instructions carefully before installation. It is very important to follow your local safety regulations and industry standards during installation. Regulations may include but are not limited to:

- Safety helmets, protective eyewear, and clothing
- Safety harnesses for all elevated workers
- Proper ladder, cage, and safety operation

Check all components and parts before installation. All parts are marked with a part number, please refer to the parts list to make sure you have all parts.

Choose a day with low or no wind to install, assembly is hard in heavy wind. Do not make any alterations to the structure. Do not hang any weights on the frame during installation, including parts. We are not responsible for any damages or injuries caused by inappropriate installation, unauthorized modifications or extreme weather.

This building is not intended for human occupancy.

It is recommended to tape or add foam/rubber on the frame where joints connect and where it touches the cover. This will help extend the life span of the cover.

Read the following item list carefully and count the number of items to ensure that all parts are included prior to setup.

Installation steps

Step 1 : Review the whole structure and choose the proper installation site

Choose a solid flat level ground area to set up the building. Do not install the building on soft ground, wetland, uneven surfaces, sloped surfaces, or on top of structures that are not rated to hold its weight.







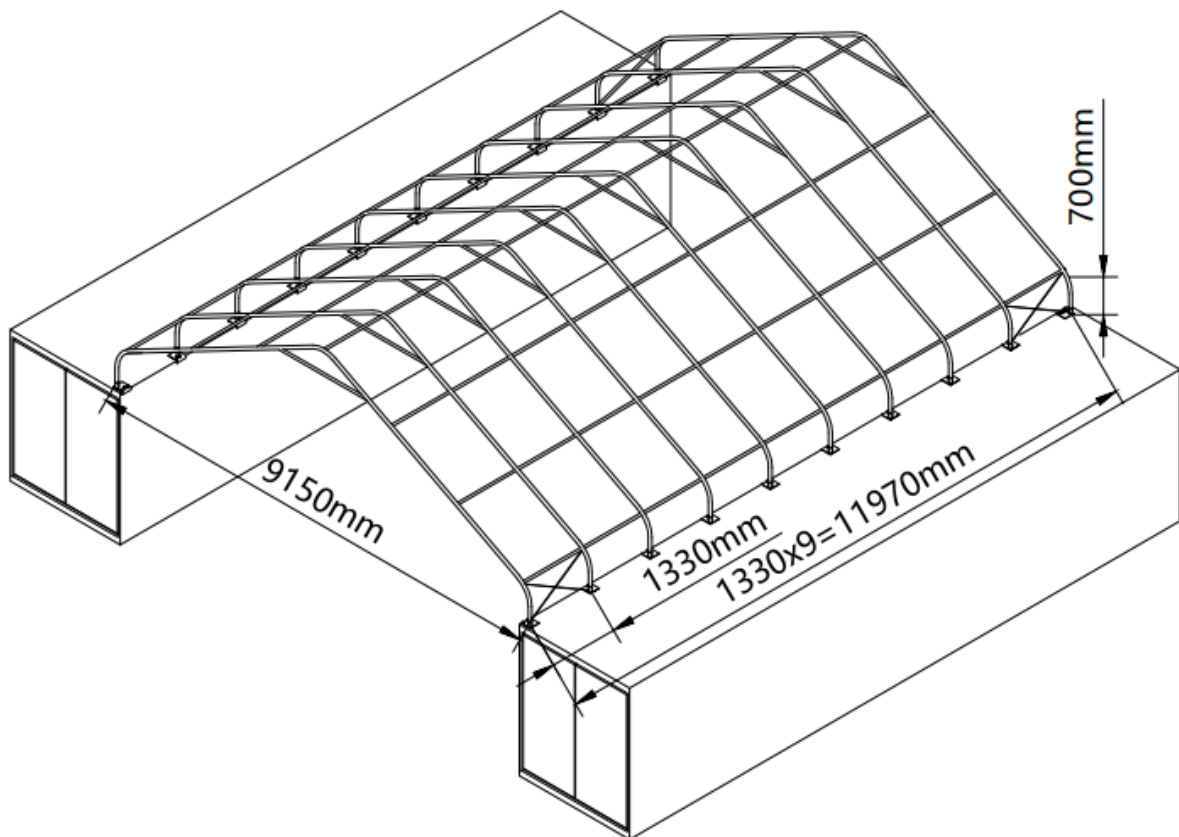





We strongly recommend that you put the containers on hard foundations before installing the shelter.

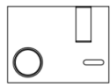
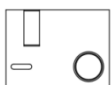



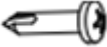
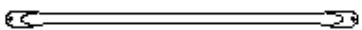

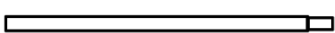

Be aware of the surrounding area. Do not set up the building near snowdrifts, open flames or exposed electrical wires. Do not keep heat sources near the fabric cover. Keep the building surroundings clear at all times.

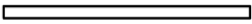
Structure diagram



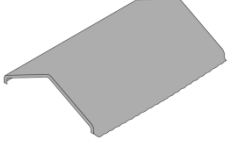

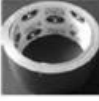

TMG-ST3041CE Part List

No.	Picture	Description	Length	Quantity
1		Peak arch tube	L1734mm	10
2		Middle rafter tube	L2890mm	20
3		Shoulder tube	L1784mm	12
3A		Shoulder tube	L1784mm	8
4		Middle truss baseplate	W150xL200mm	16
4L		Left corner baseplate (front and rear truss)	W150xL200mm	2
4R		Right corner baseplate (front and rear truss)	W150xL200mm	2
5		Roof purlin (horizontal tube)	L1268mm	63
5A		Middle truss connectors	W50xL180mm	112
5B		Front and rear connectors	W50xL121mm	14
5C		Self-tapping screws (#12x25mm)	#12x25mm	70
6		Ceiling cross bar	L2190mm	10
7		Sidewall frame steel tension cables	L1300mm	8
7A		Ratchet	2T	20
7B		Ratchet straps	W38xL800mm	20
8		Mounting base	W40xL100mm	8
9		Top cover tension tube (for both bottom sides)	L1993mm	12

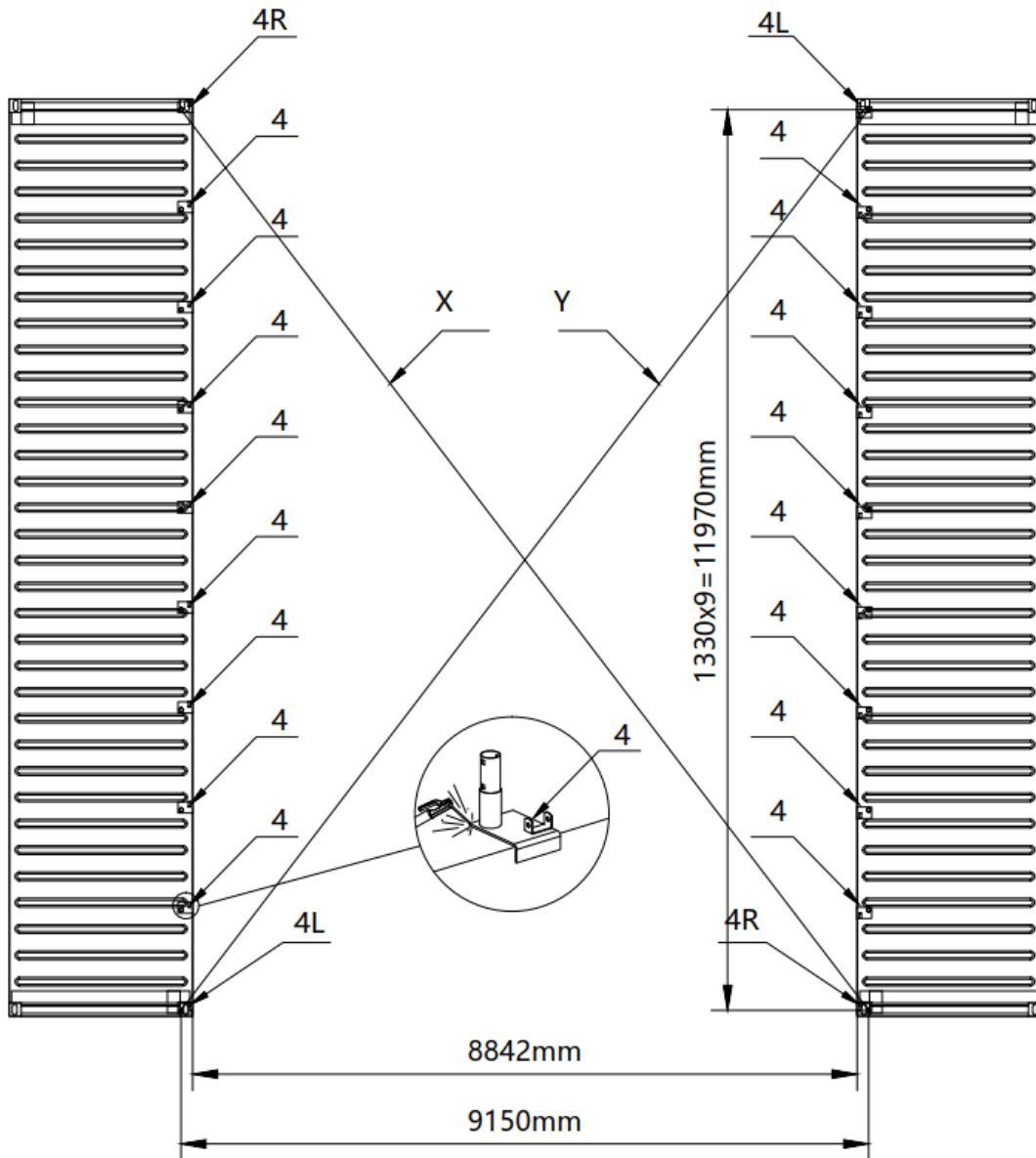
9A		Top cover tension tube	L490mm	2
10		Bolt M8x60	M8x60mm	126
11		Bolt M8x70	M8x70mm	120
12		Hex bolt M10x30mm	M10x30mm	20
13		Top cover		1
14		Braided rope (80m)	φ8x80m	1
15		Scratch resistant tape	10m	2
16		Water plug	φ32	4

Step 2 : Place the containers making sure they are parallel and the correct width apart. Make sure there is a gap of about 3 feet around the building. the center point of the round pipe of the base is the reference point, and the diagonal X and Y must be equal. The base plate shall be welded to the top of the container on the same horizontal plane to ensure that the welding is firm and reliable.





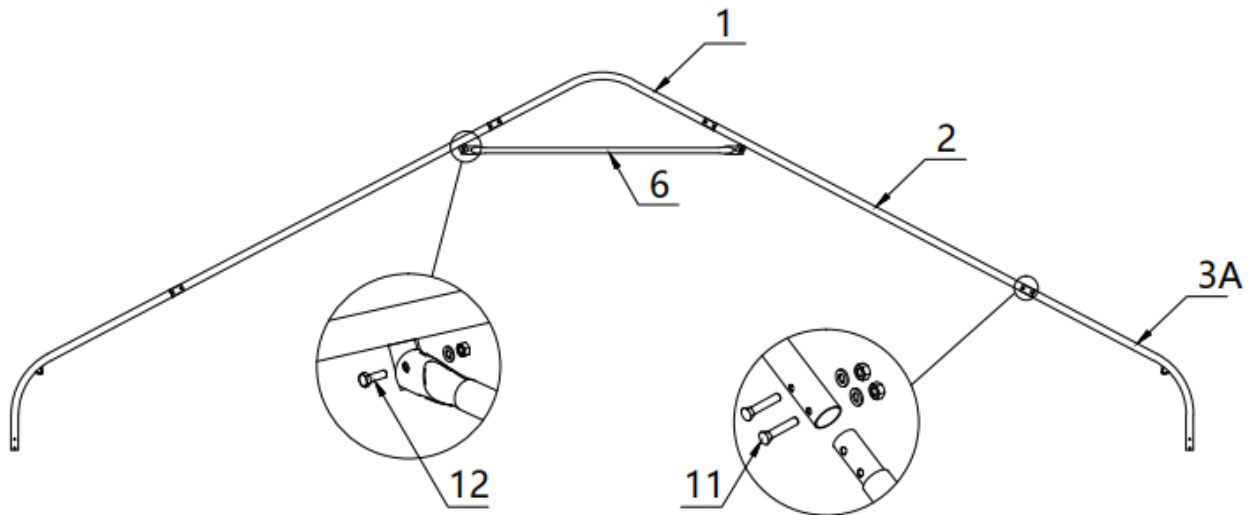

No.	Part	Qty
4		16
4L		2
4R		2

Step 3 : Connect all trusses.

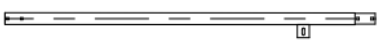
- Front and rear trusses (4 trusses).

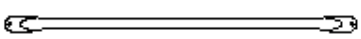
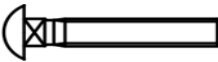

No.	Part	Qty
1		1x4
2		2x4
3A		2X4

No.	Part	Qty
6		1x4
11		8x4
12		2x4

Middle trusses (6 trusses).

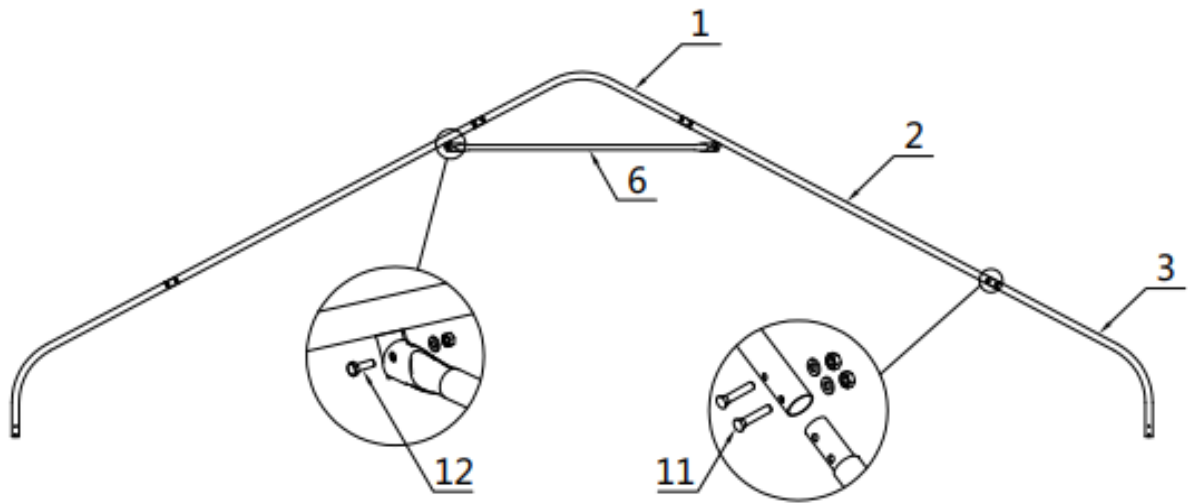

No.	Part	Qty
1		1x6
2		2x6
3		2X6

No.	Part	Qty
6		1x6
11		8x6
12		2x6

Lay down all (10) trusses on the ground when the assembly is all completed and before moving to next step, and then wrap (#15) around the sharp points of the joint to avoid friction between the fabric and the interface, resulting in fabric damage.

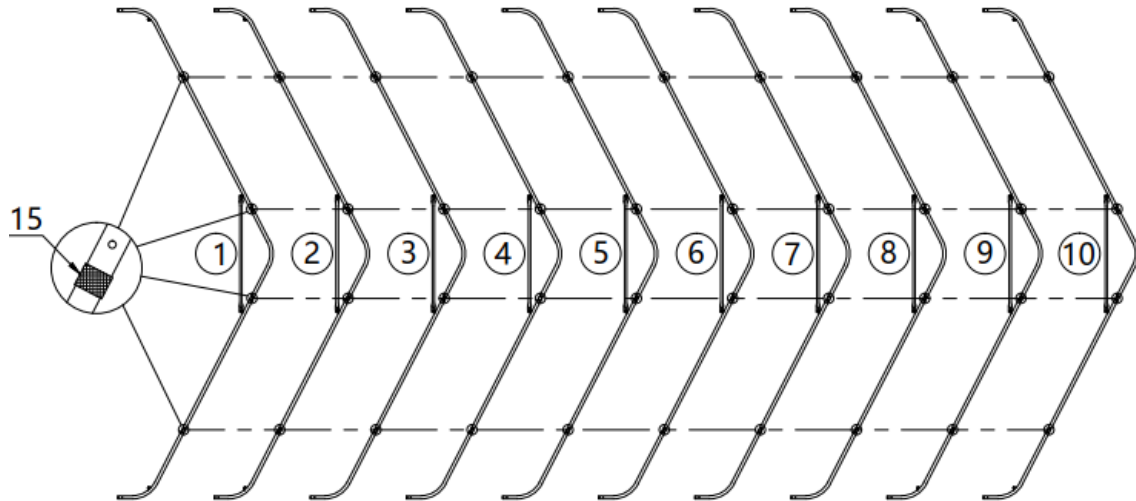

No.	Part	Qty
15		2

Step 4 : Put up all trusses.



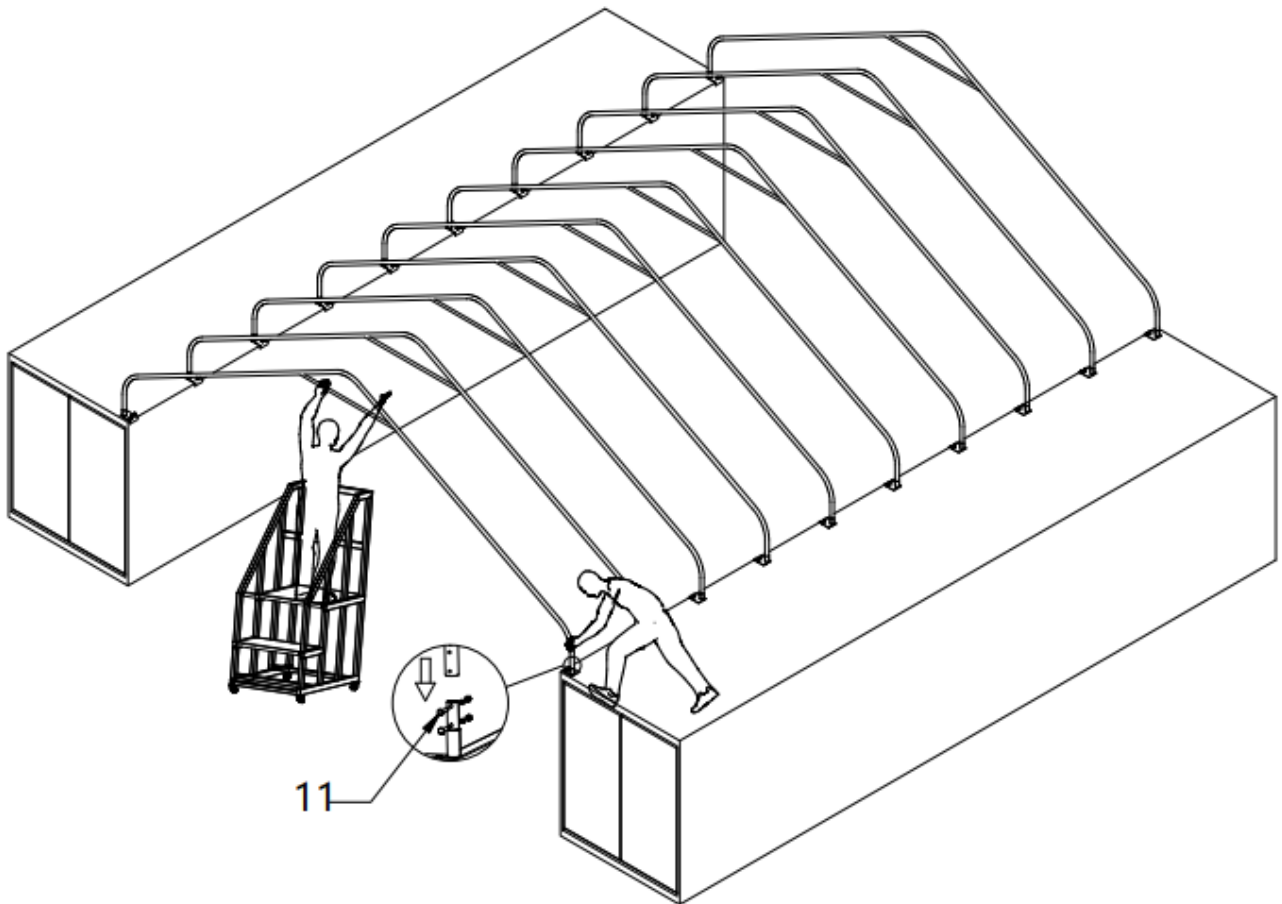

Install each truss on the base tube. Use hex bolt (#11) to secure the truss to the base tube firmly. We recommend to use a crane or forklift to lift the truss and have 2 to 3 people on site to work together. Please make sure it is safe and secure when installation is proceeding.



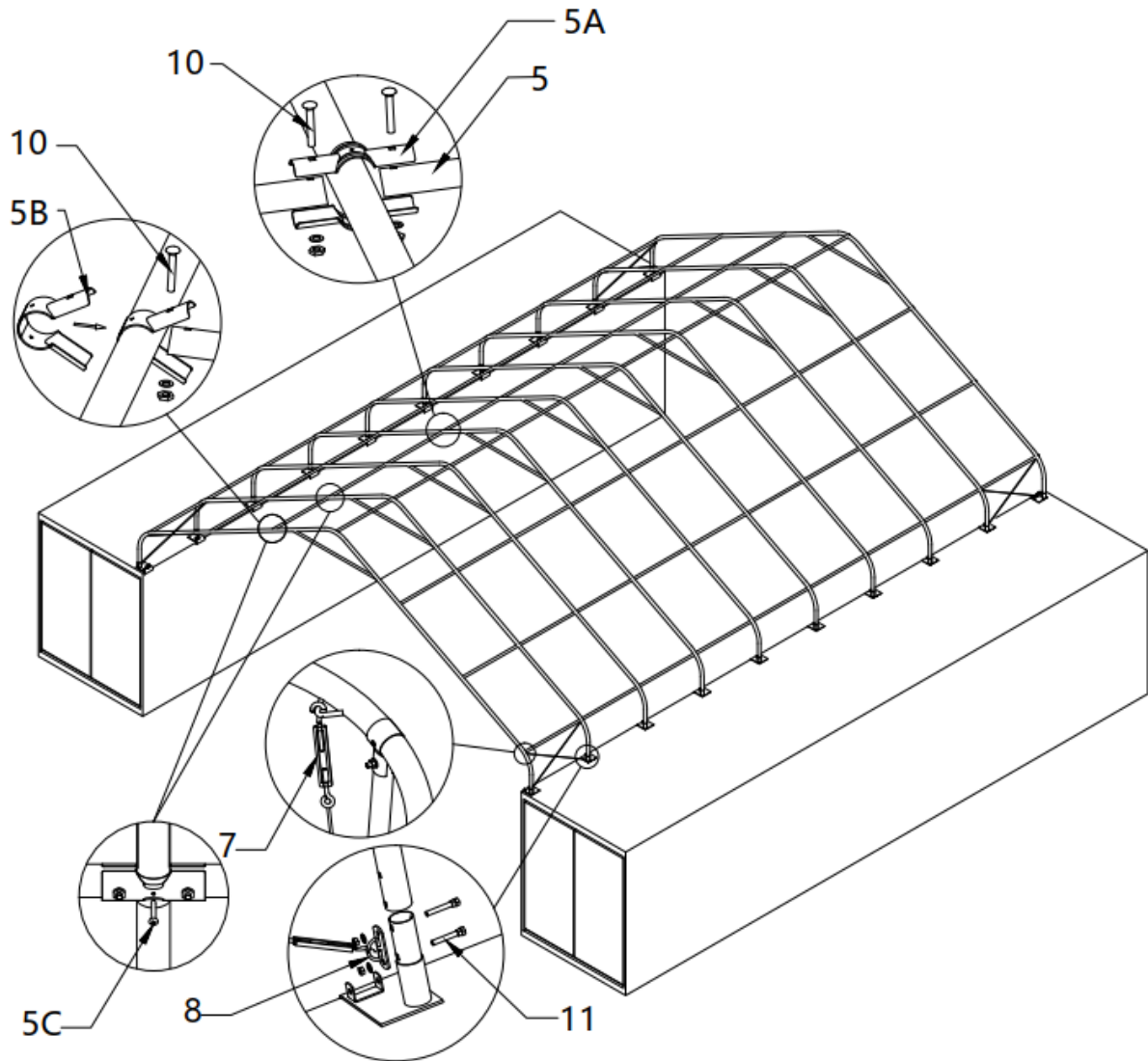

No.	Part	Qty
11		40

Step 5 : Install cross tubes and wire ropes.



No.	Part	Qty
5		63
5A		112
5B		14
5C		70

No.	Part	Qty
7		8
8		8
10		126

Overall structural inspection :

Check all components and trusses to ensure the entire structure is rectangular as specified in (picture1). All trusses must be 90 degrees straight up from the container.

Secure and tighten all bolts and nuts on this step. But do not over tie! Otherwise you might damage the tubes or components.



Step 6 : Install the top cover (#13) stretch and tighten top cover.

Do not install the cover during windy weather!

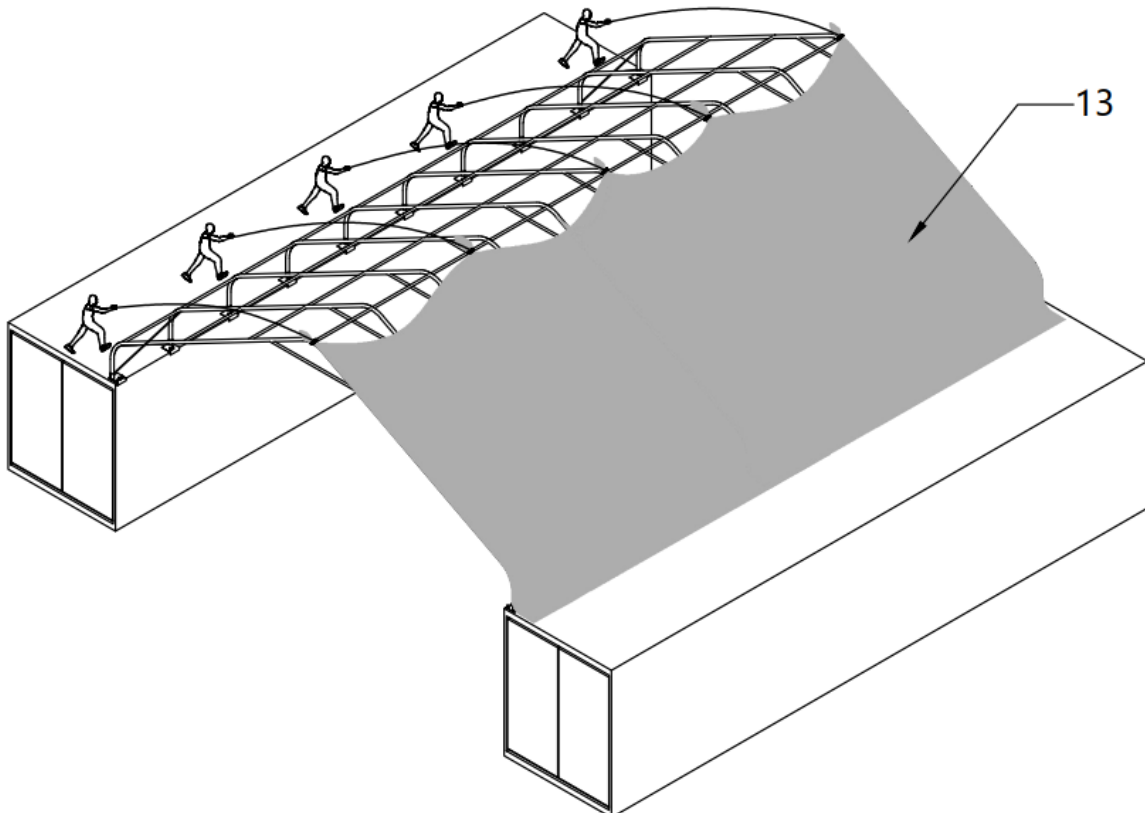
- Stretch and adjust the cover from back and forth, to make sure it is square and centered.
- Unpack the top cover and place it along one of the long sides of the structure.
- Use 3 to 5 ropes (#13) to pull the cover over the top of the structure, from the inside 2 or 3 people standing inside on ladders to push upwards will help to move the cover without any damage.

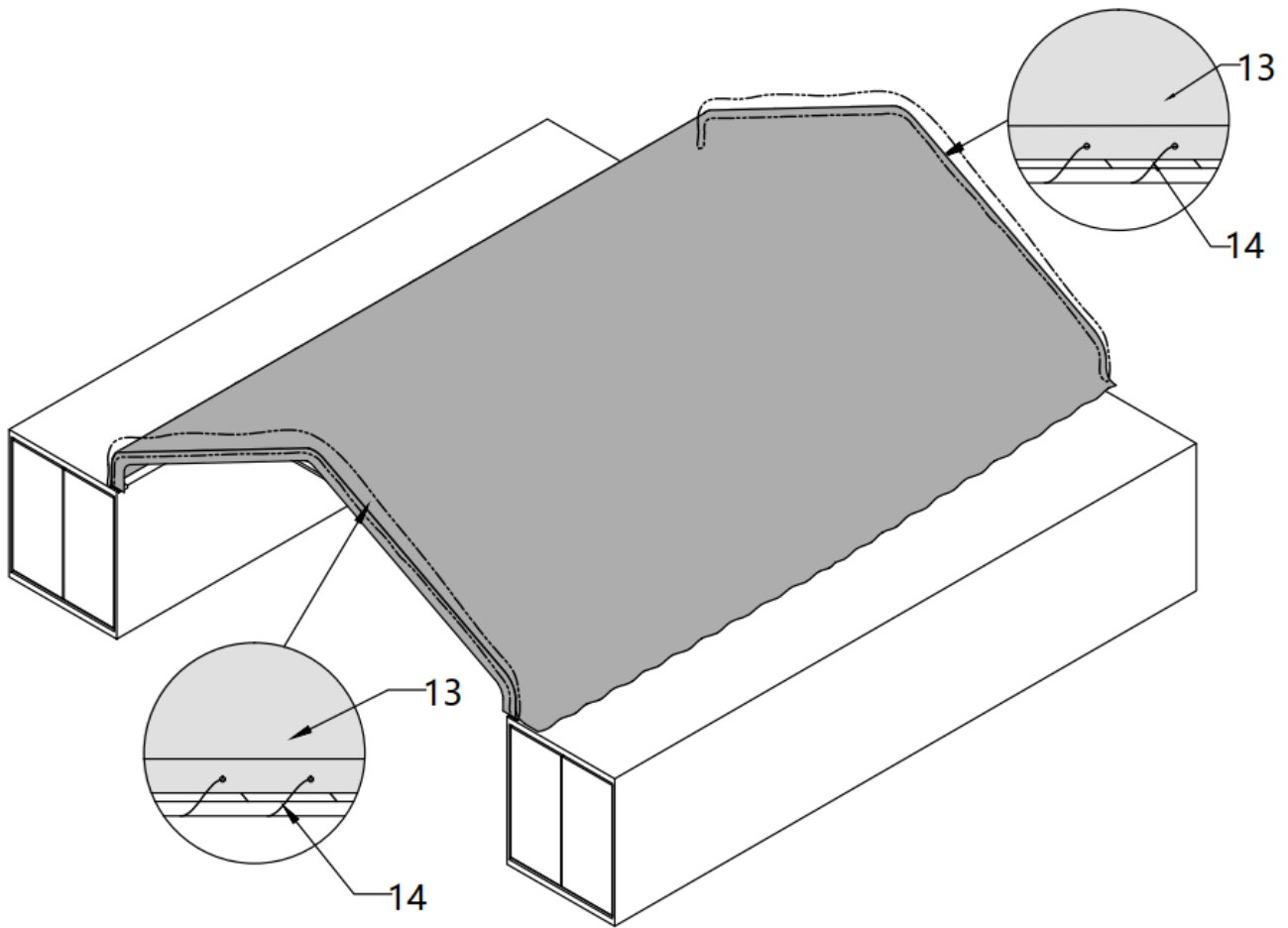

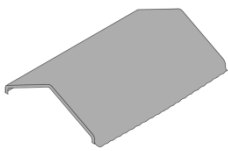



NO.	Part	Qty
13		1
14		80m

Rope Shear Size		
14		Qty
14	2000mm	4

Step 7 : Tension the cover on the structure from both sides.

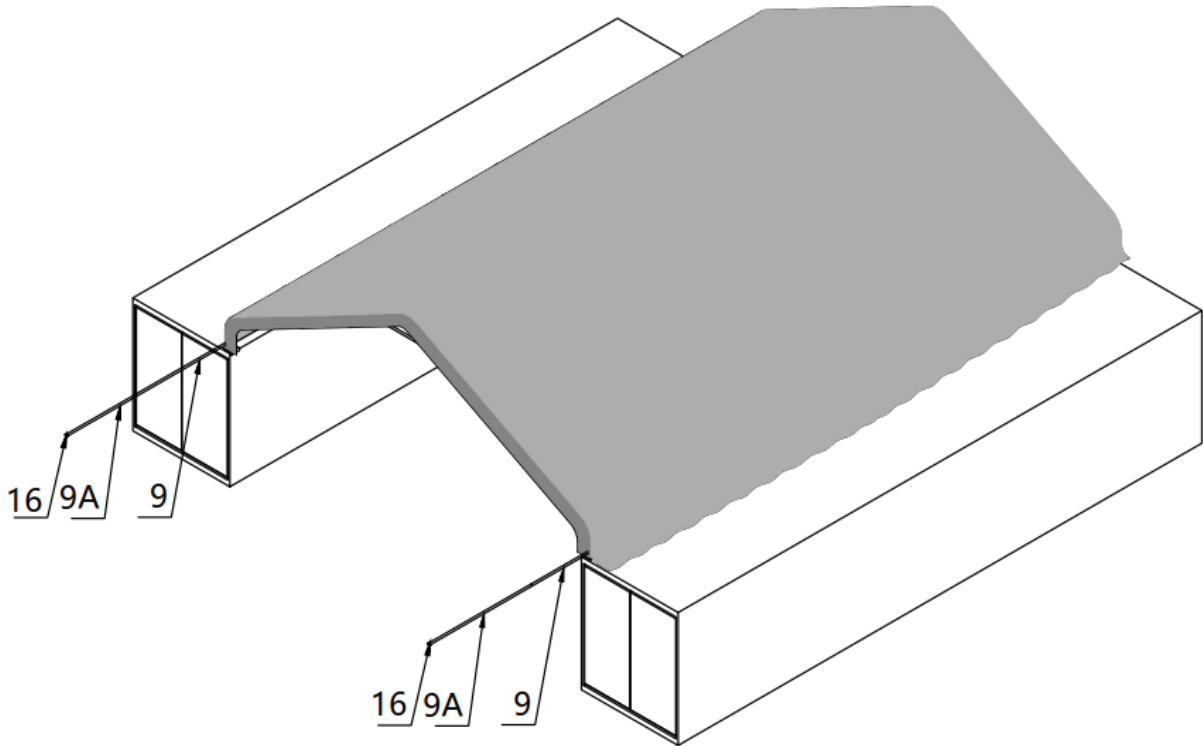
- Insert tension tubes (#9) slowly into the bottom groove pocket on both long sides. Add the water plug (#16) on the first tension tube to avoid tearing the fabric and add one to the end of last tube as well.
- Repeat the same step for the other side.

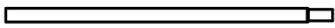



NO.	Part	Qty
9		12
9A		2
16		4

Step 8 : Install ratchet straps.

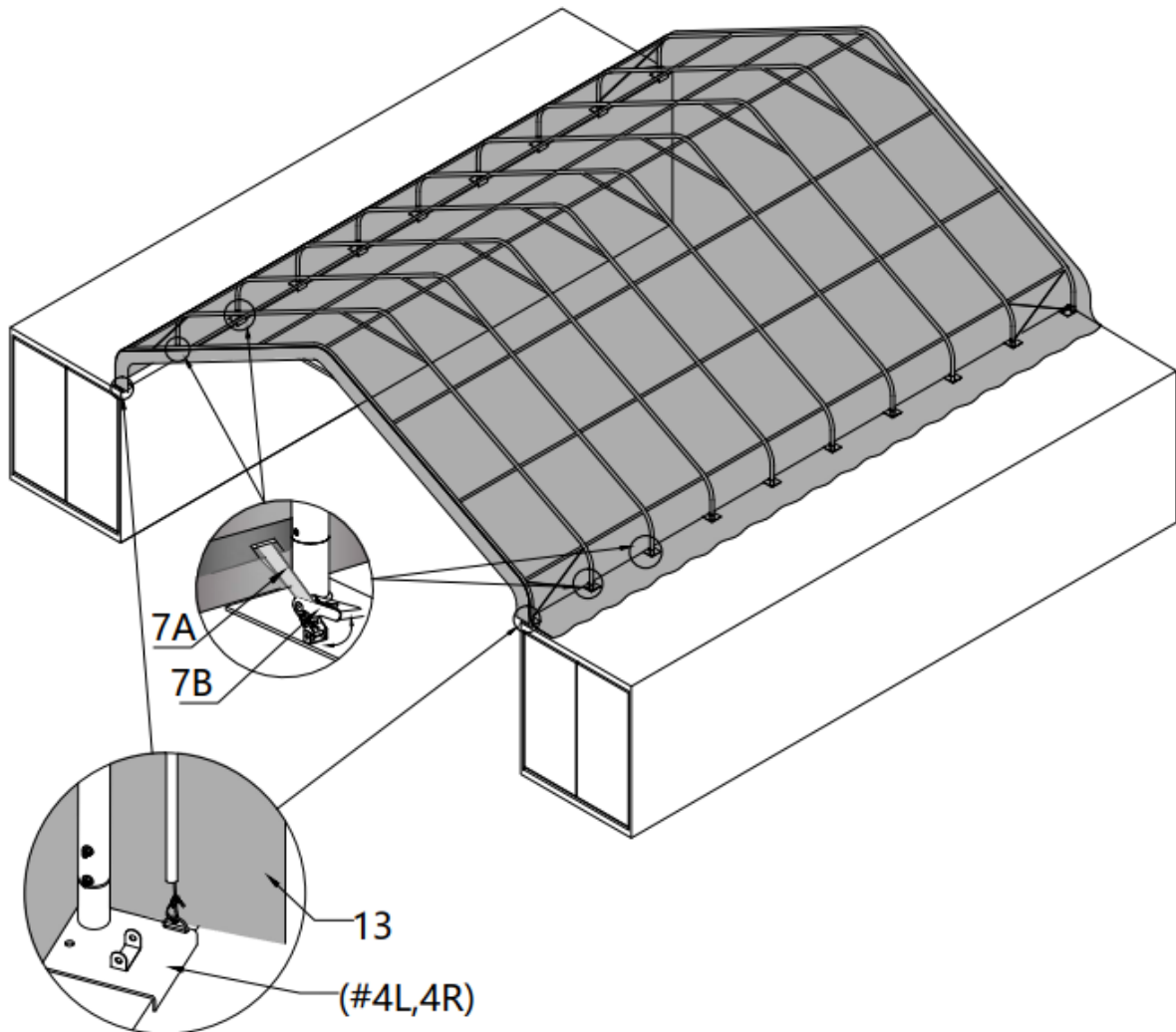
- Stretch and adjust the cover from left and right, back and forth, to make sure it is square and centered. Cut the groove pocket where it aligns with ratchet (#7A), and use strap (#7B) to pull tension tube (#9) to ward the ratchet and secure it.
- Evenly adjust all ratchets on both sides to take wrinkles out and make the cover flat and smooth.



NO.	Part	Qty
7A		20
7B		20

After Installation

Walk around and inspect the building periodically to make sure the parts are firmly fixed and the whole building is well supported. Check all bolts and hardware connectors to make sure they are in place and tightened. Check the base plates, adjust the ropes if necessary and clean the cover regularly.

Snow accumulating on the fabric cover must be removed as soon as possible. If snow is allowed to become solid ice on the cover, it could increase the weight on the roof and collapse the building or reduce the life span.

We strongly recommend you remove any snow from the roof immediately. Do not leave any snow load on the roof overnight. Keep 3 feet of clearance on all sides at all times. Do not allow snow to accumulate and pile up on the sides of the building. Otherwise the pressure from the sides will push inwards and could lead to a collapse.