

MODEL TMG-ST2041V

20 x 40 FT STRAIGHT WALL STORAGE SHELTER

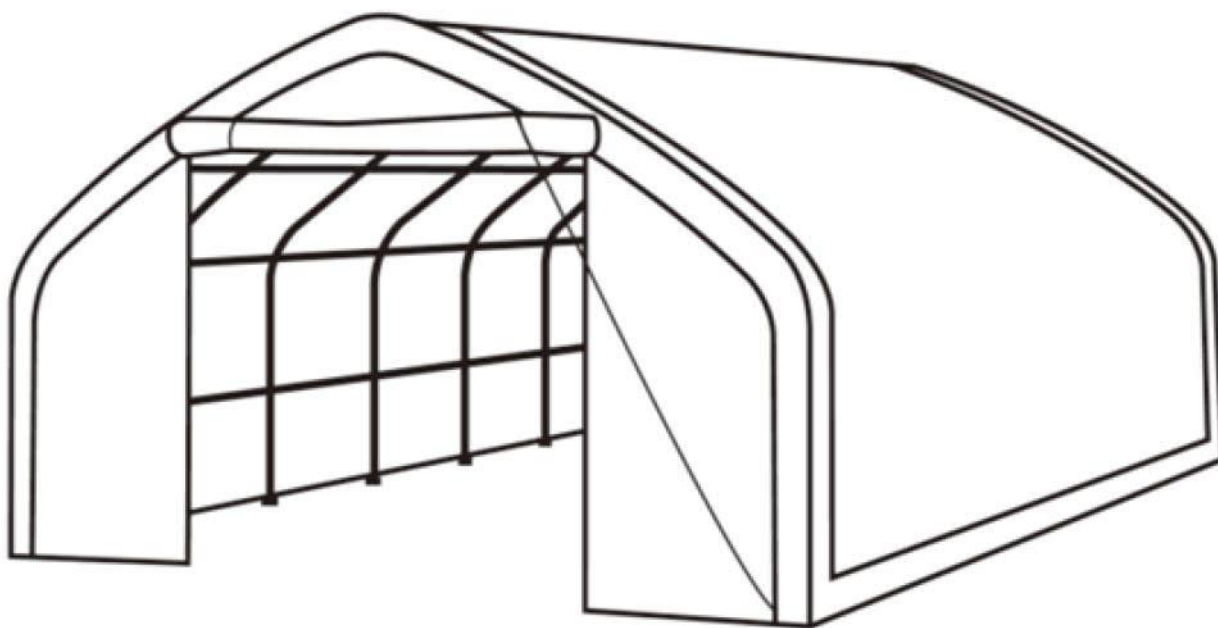

⚠ WARNING



- Please read and understand the product manual completely before assembly
- Check against the parts list to make sure all parts are received
- Wear proper safety goggles or other protective gears while in assembly
- Do not return the product to dealer. They are not equipped to handle your requests.

Missing parts or have questions on assembly?

Please call: 1-877-761-2819 or email: cs@tmgindustrial.com

Main Specifications :

- Overall assembled size : W6 x L12 x H3.65 (m) / 19.68 x 39.37 x 11.97 (ft)
- Shoulder height : 2 (m) / 6.56 (ft)
- Front and rear roll up door : 3 x 3 (m) / W9.84 x H9.84 (ft)

Prior to assembly

Please read the instructions carefully before installation. It is important to follow your local safety regulations and industry standards during installation. Regulations may include but are not limited to :

- Safety helmets, protective eyewear, and clothing.
- Safety harnesses for all elevated workers.
- Proper ladder, cage, and safety operation.

Check all components and parts before installation. All parts are marked with a part number, please refer to the parts list to make sure you have all parts.

Choose a day with low or no wind to install, assembly is hard in heavy wind. Do not make any alterations to the structure. Do not hang any weights on the frame during installation, including parts. We are not responsible for any damages or injuries caused by inappropriate installation, unauthorized modifications or extreme weather.

This building is not intended for human occupancy.

It is recommended to tape or add foam/rubber on the frame where joints connect and where it touches the cover. This will help extend the life span of the cover.

Read the following item list carefully and count the number of items to ensure that all parts are included prior to setup.

Installation steps







Step 1 : Review the whole structure and choose the proper installation site





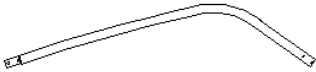
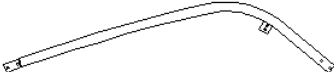
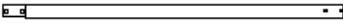

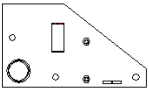

Choose a solid flat level ground area to set up the building. Do not install the building on soft ground, wetland, uneven surfaces, sloped surfaces, or on top of structures that are not rated to hold its weight.

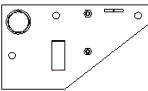
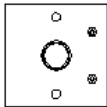
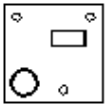

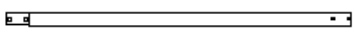
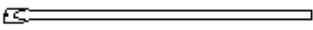

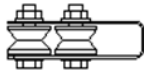
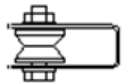

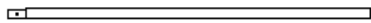

We strongly recommend that you build the structure on a solid foundation such as cement and use anchor bolts on all baseplates.

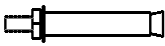
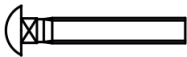
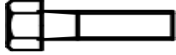
Be aware of the surrounding area. Do not set up the building near snowdrifts, open flames or exposed electrical wires. Do not keep heat sources near the fabric cover.

Keep the building surroundings clear at all times.

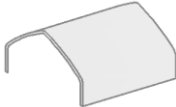
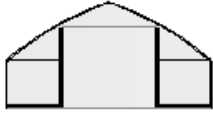
TMG-ST2041V Part List				
Parts code	Graphical	Description	length	Qty
1		Peak arch tube	φ48xL1820mm	9
2		Upper rafter tube (middle truss)	φ48xL1934mm	14
2A		Upper rafter tube (front truss)	φ48xL1934mm	4
3		Shoulder tube (middle truss)	φ48xL1123mm	14
3A		Shoulder tube (front and rear truss)	φ48xL1123mm	4
4		Sidewall tube	φ48x1480mm	18
5		Roof purlin (horizontal tube)	φ42x1440mm	72
5A		Middle truss connectors	W50xL170mm	126
5B		Front and rear connectors	W50xL111mm	18
5C		Self-tapping screws	#12x25mm	81
5L		Left corner baseplate (front and rear truss)	W200xL350mm	2

5R		Right corner baseplate (front and rear truss)	W200xL350mm	2
6		Door column baseplate (front truss)	W150xL200mm	4
7		Middle truss baseplate	W150xL200mm	14
7A		Ratchet	2T	18
8		Door frame lower tube (front and rear truss)	φ48xL1980mm	4
9		Door frame upper tube (front and rear truss)	φ48xL1405mm	4
10		Door frame horizontal tube (front and rear truss)	φ42xL1446mm	4
11		Ceiling cross bar	φ42xL1949mm	9
11A		Two wheel rope pulley (pre-installed on 2A)	W30xL130mm	2
11B		One wheel rope pulley (pre-installed on 2A)	W30xL85mm	2
12		Bottom tension bar (front and rear cover)	φ32xL1300mm	4
13		Diagonal bracing bar (1st and last span)	φ32xL1920mm	4
13A		Tube clamp	φ48mm	8
14		Top cover tension tube (for both bottom sides)	φ32xL1993mm φ32xL500mm	2 groups
15		Door dropping tube	φ32xL1993mm φ32xL1360mm	2 groups

16		Expansion bolt (not included)	φ14x100mm	62
17		Half round head bolt	M8x60mm	162
18		Hex Bolt	M10x70mm	168
19		Hex Bolt	M10x30mm	26
19A		Hex Bolt	M10x50mm	8
20		Nylon rope	φ8xL12m	4
21		Water plug	φ32mm	16
22		Top cover		1
23		Front cover panel		2
24		Braided rope	φ8xL180m	1 bundle
25		Ratchet straps	W38xL800mm	18
26		Scratch resistant tape	10m	3

Step 1 : Base plates installation.

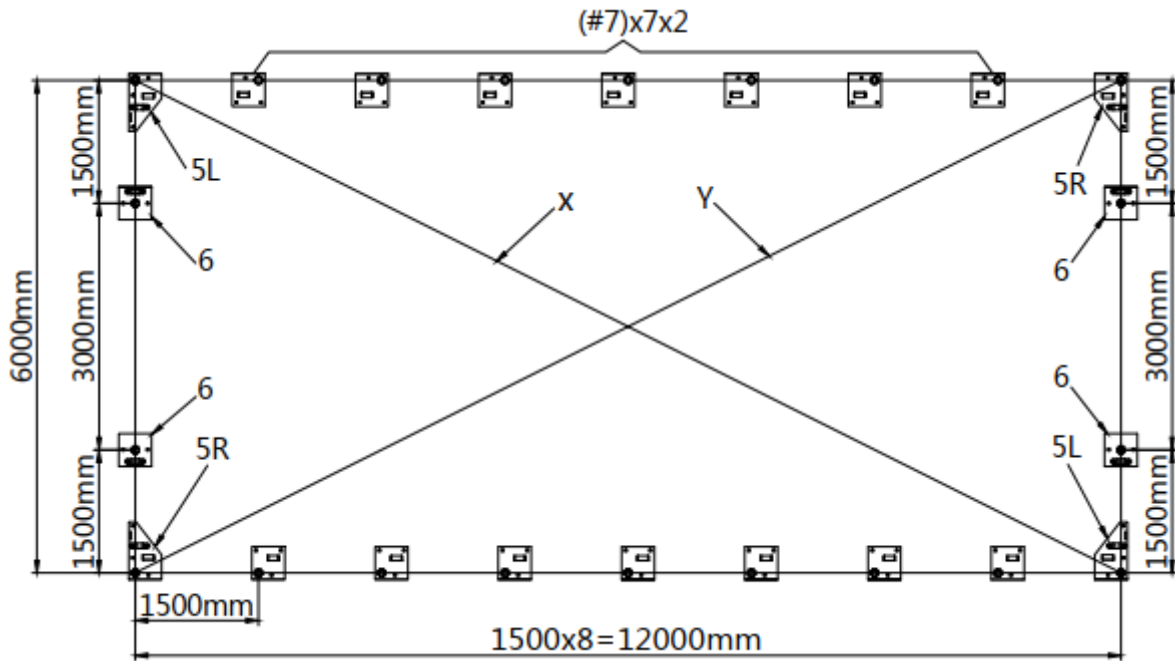

- Installation diagram of expansion bolt.

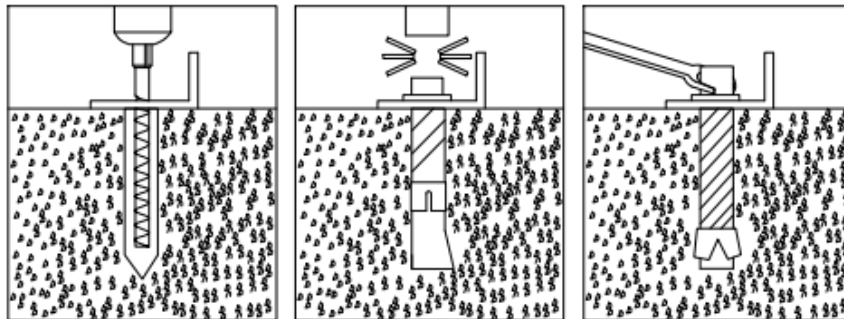

NO.	Part	Qty
5L		2
5R		2
6		4

NO.	Part	Qty
7		14
16		62

Step 2 : Install front and rear truss.

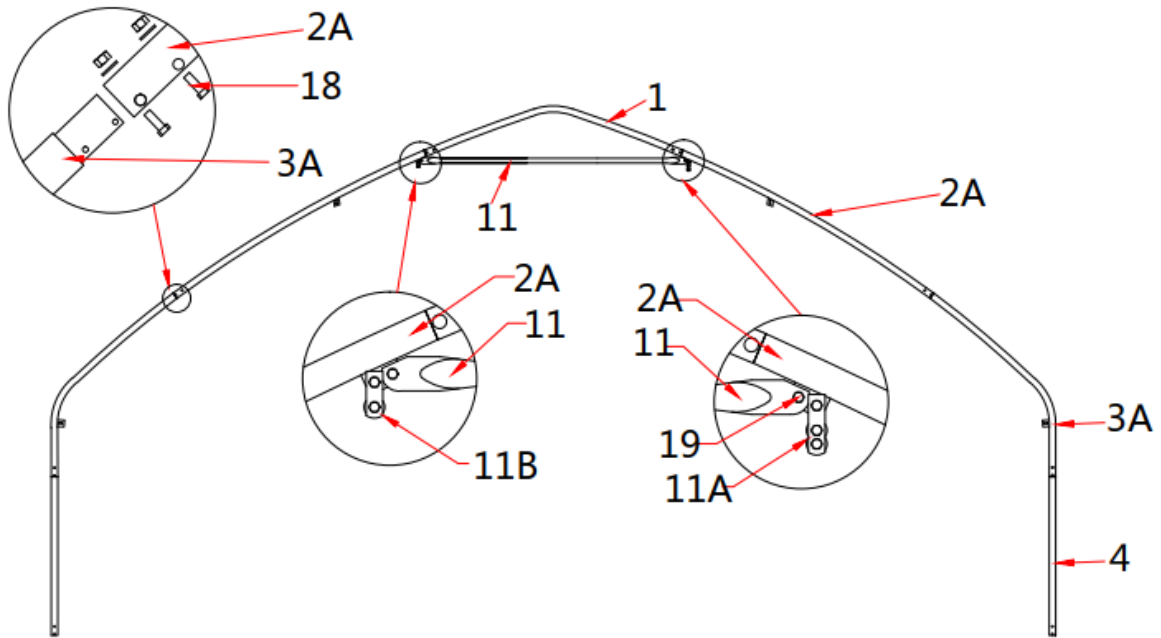

NO.	Part	Qty
1		2
2A		4
3A		4
4		4
11		2

NO.	Part	Qty
11A		2
11B		2
18		24
19		4

Step 3 : Install the middle truss.

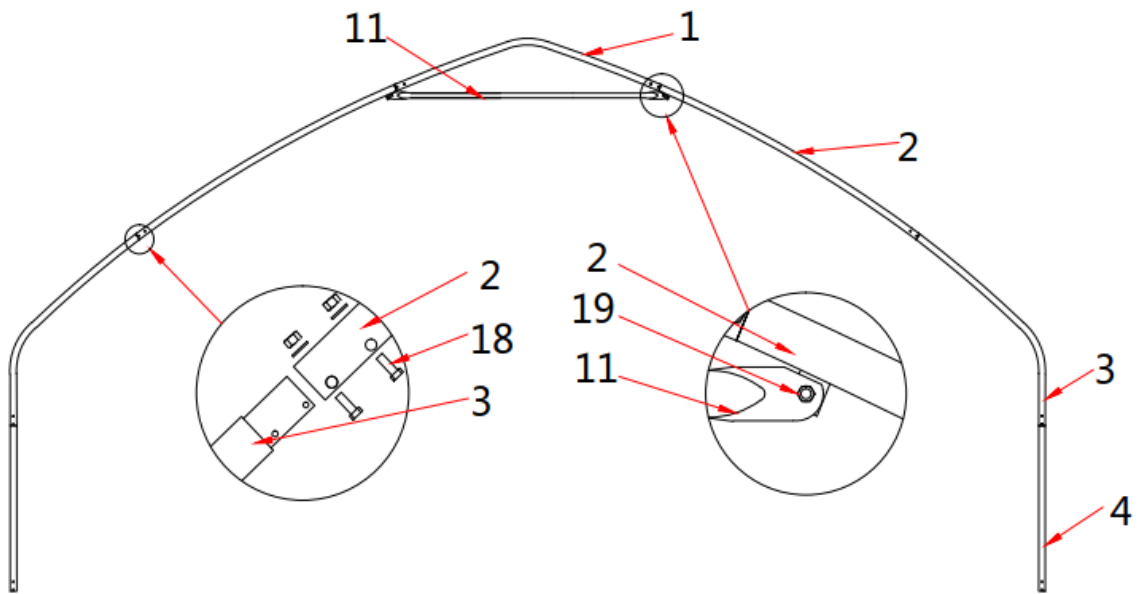

NO.	Part	Qty
1		7
2		14
3		14
4		14

NO.	Part	Qty
11		7
18		84
19		14

Step 4 : Wrap (#26) around the sharp points of the joint to avoid friction between the fabric and the interface.

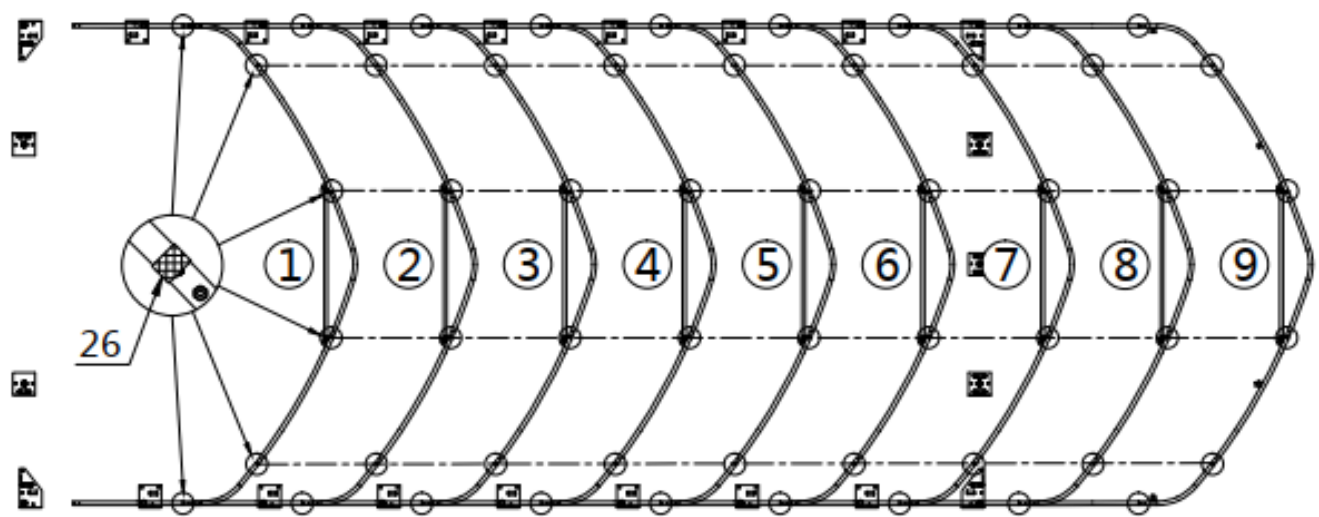

NO.	Part	Qty
26		3

Step 5 : Put up the front and rear truss and the intermediate trusses.

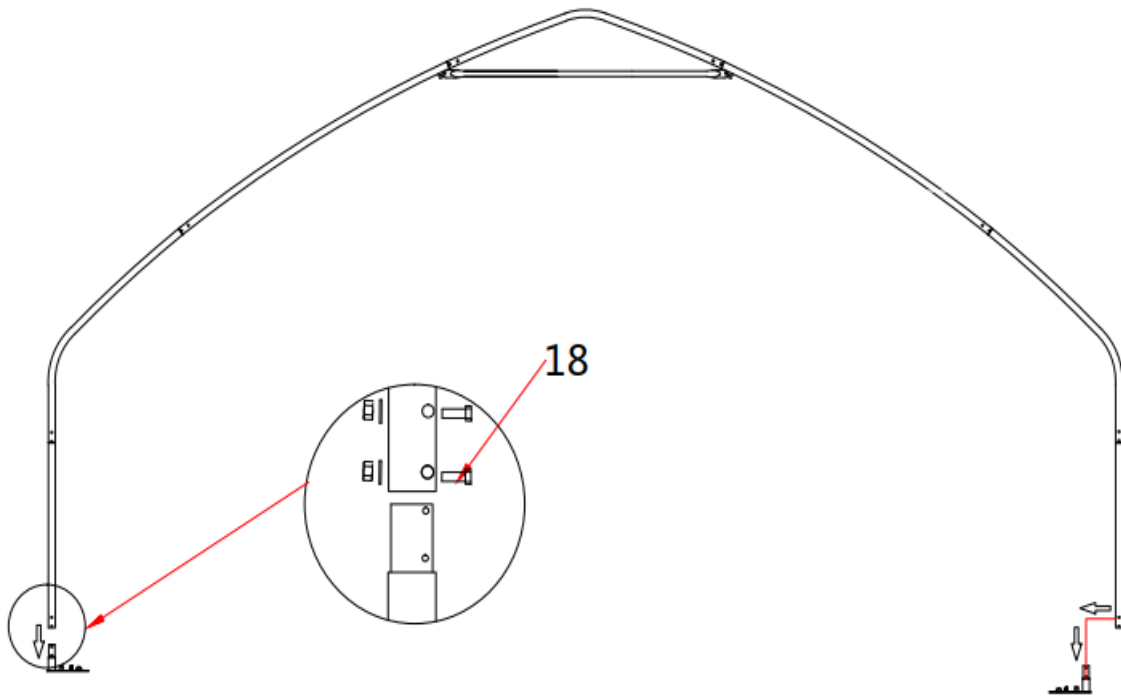

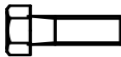
NO.	Part	Qty
18		36

Step 6 : Install (#5) roof purlin.

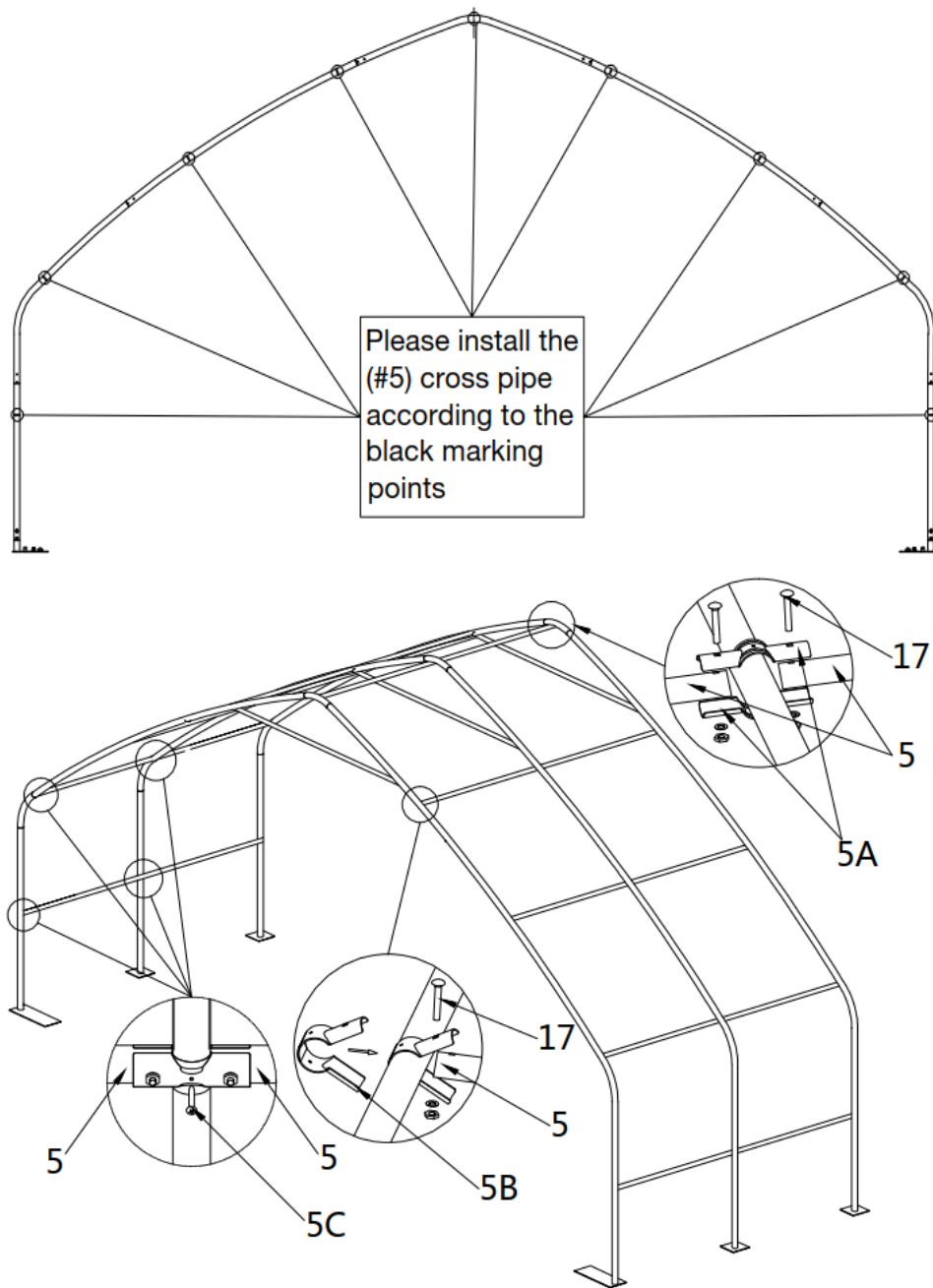



NO.	Part	Qty
5		72
5A		126
5B		18

NO.	Part	Qty
5C		81
17		162

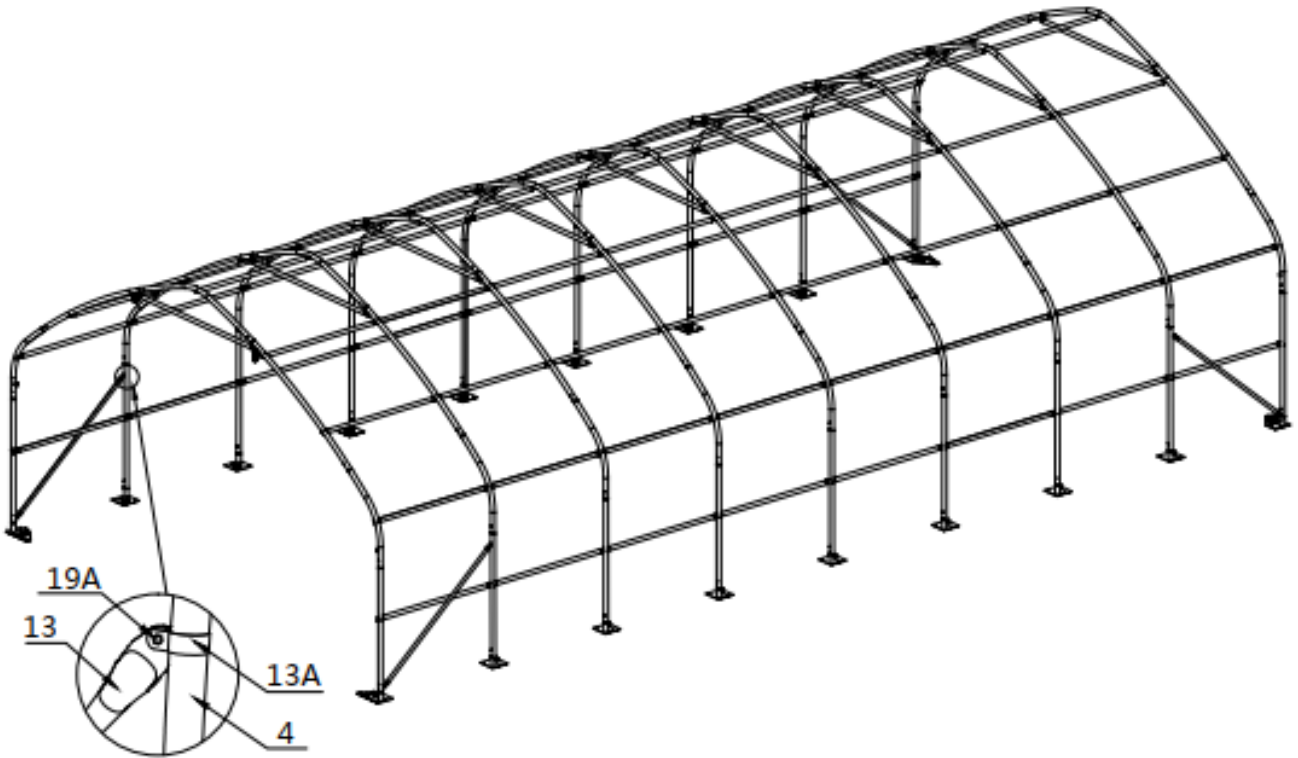
Step 7 : Install the diagonal bracing bars (#13).



NO.	Part	Qty
13		4
13A		8
19A		8

Step 8 : Install the remaining parts on the front and rear trusses.

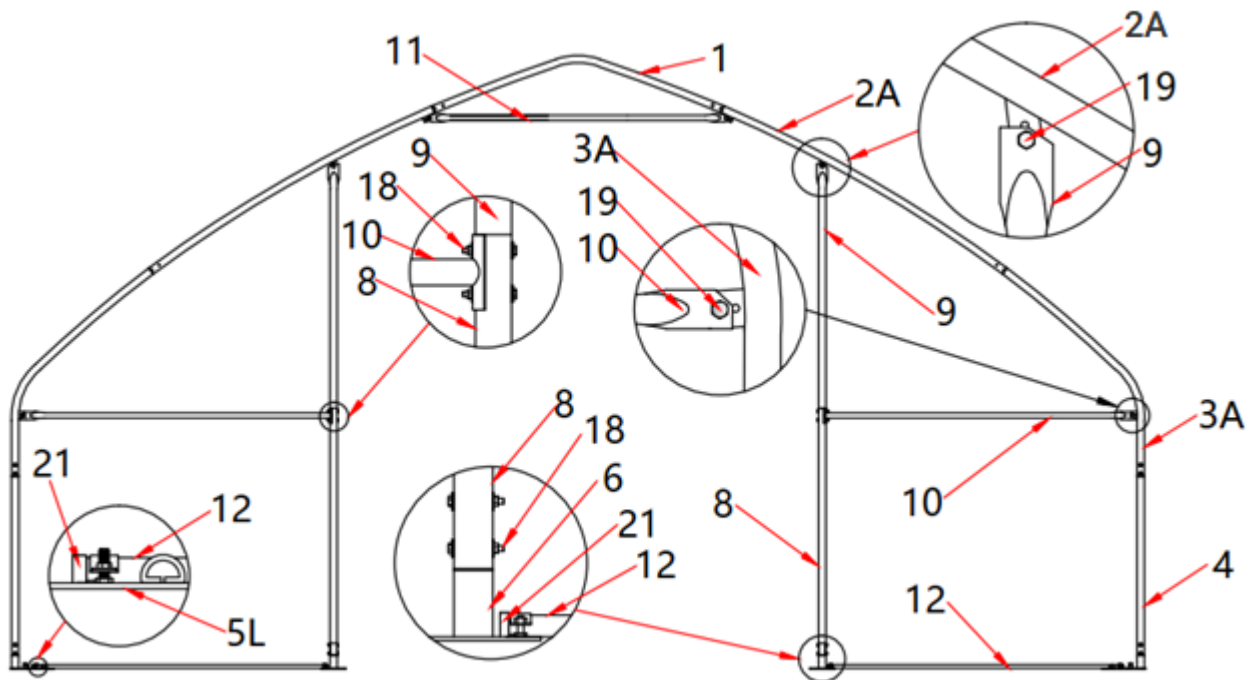

NO.	Part	Qty
8		4
9		4
10		4
12		4

NO.	Part	Qty
18		16
19		8
21		8

Step 9 : Install front and rear cover panel.

- Lift up (#23) cover panels, starting from the center point of the frame (highest ridge point) , use ropes (#24) Center point through the grommets to tie the panel to the truss firmly. Then continue from the middle to the sides to tie the panels to the arch pipe.
- Insert the dropping tube (#15) into the bottom groove pocket on the door cover.
- Tie two ropes (#20) separately on both sides of the peak arch tube. Pull both ropes under through the bottom of the door cover from the back, then go up from front and through both pulley 11A and 11B.

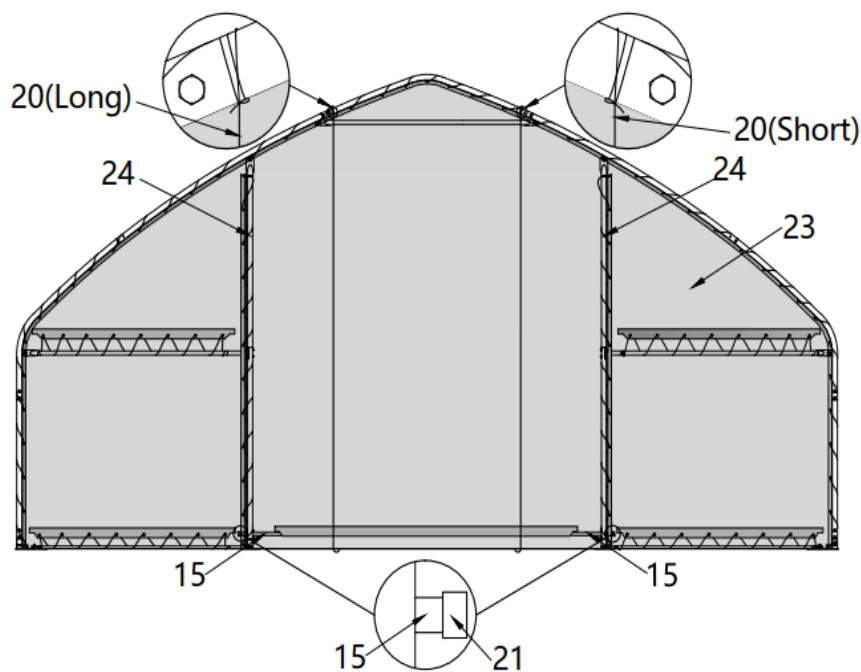

NO.	Part	Qty
15		2
20		4
21		4
23		2
24		70m

Rope Shear Size		
24		Qty
A	18000mm	2
B	4500mm	2
C	2000mm	8

What you see in this photo is outside

- The rope coming out from pulley 11B must go through the upper wheel of pully 11A, then pull both ropes together slowly and start to lift the door cover.
- Tie both ropes to the corner baseplate. Now the door cover is up. When you drop down the door cover, do not let go too quick, otherwise it might get stuck and damage the fabric.

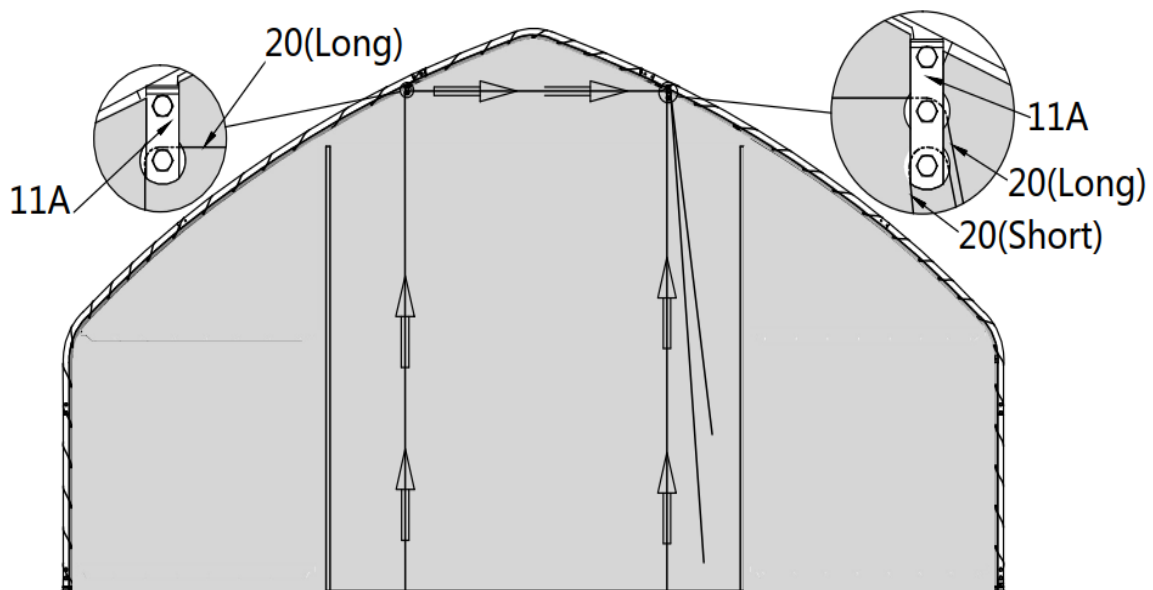

Step 10 : Install the top cover (#22) stretch and tighten top cover.

Do not install the cover during windy weather!

- Stretch and adjust the cover from back and forth, to make sure it is square and centered.
- Unpack the top cover and place it along one of the long sides of the structure.
- Use 3 to 5 ropes (#22) to pull the cover over the top of the structure, from the inside 2 or 3 people standing on ladders to push upwards will help to move the cover without any damage.

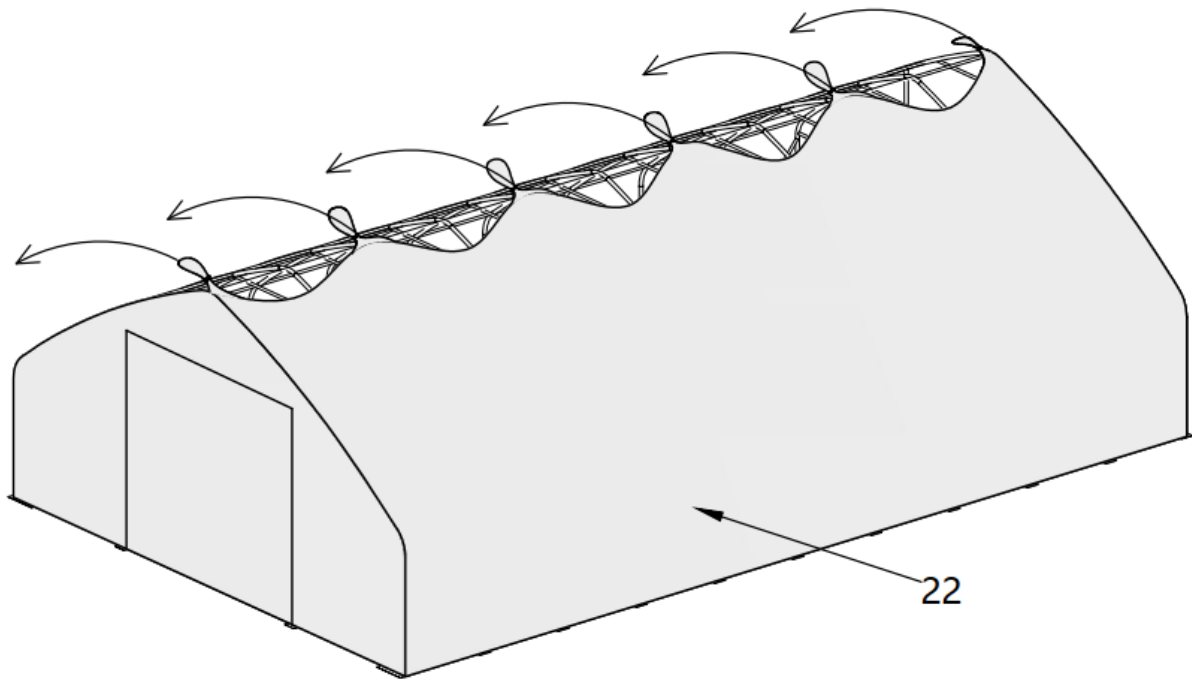

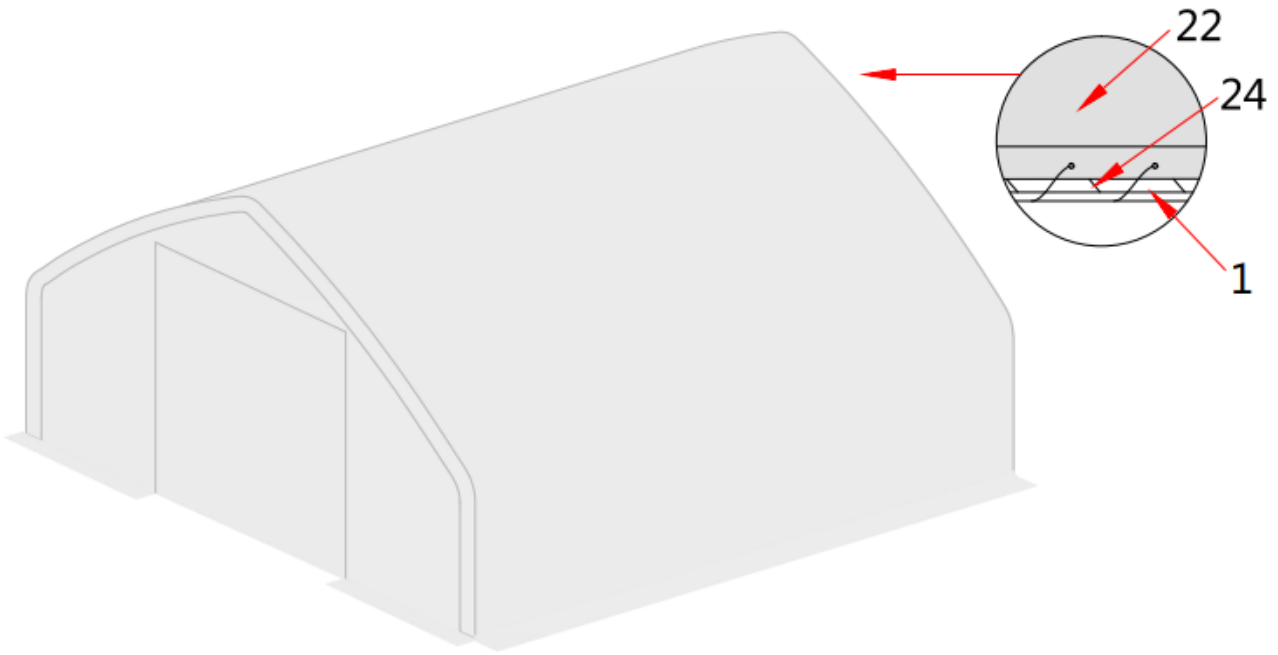

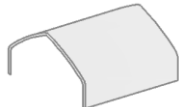

NO.	Part	Qty
22		1

NO.	Part	Qty	NO.
24		1	1

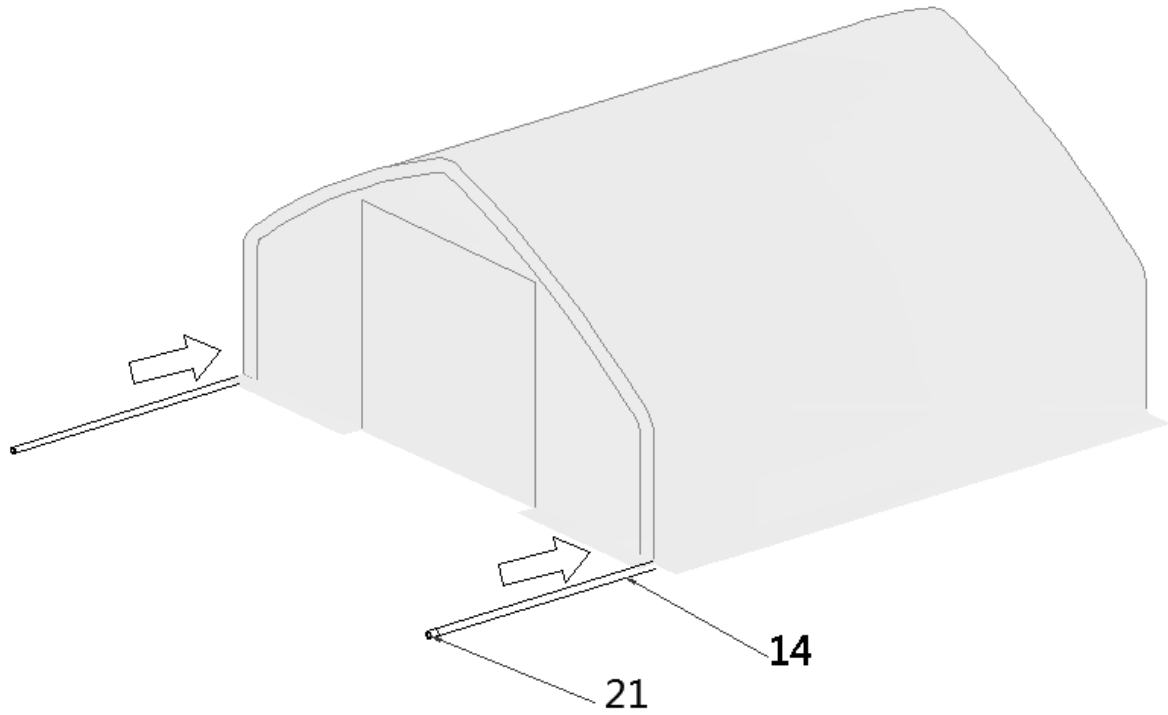

Step 11 : Tension the cover on the structure from both sides.

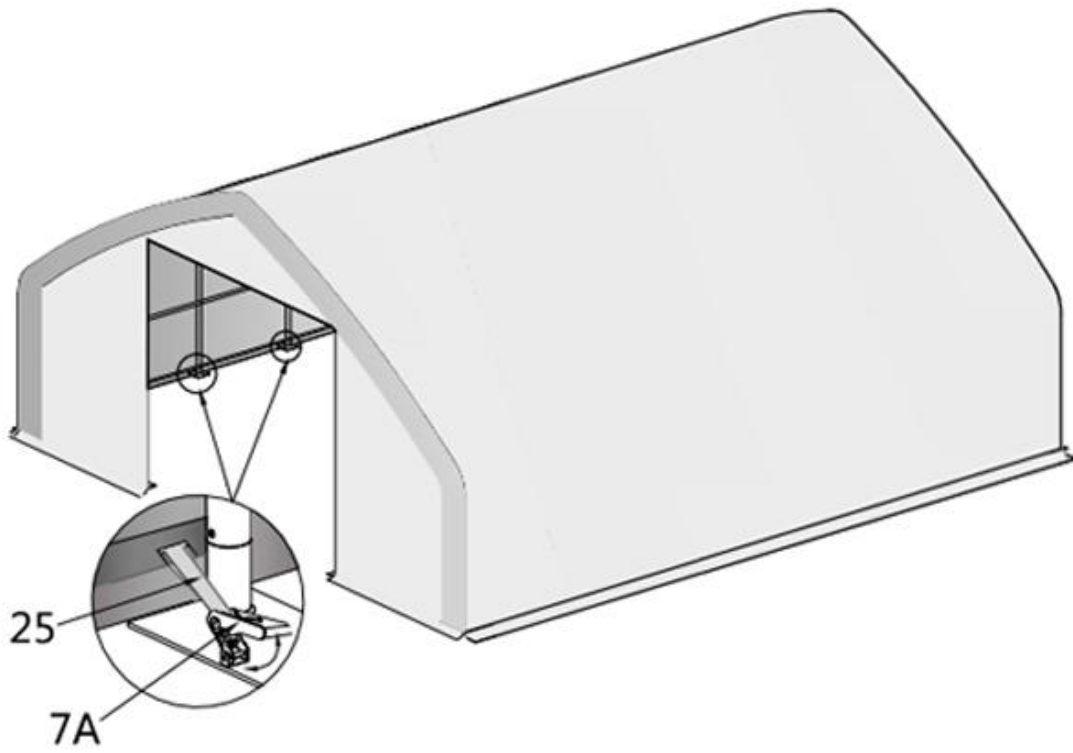

NO.	Part	Qty
14		2
21		4

Step 12 : Install ratchet straps.



NO.	Part	Qty
7A		18
25		18

After the Installation

Walk around and inspect the shelter periodically to make sure all components are still firmly secured and the whole shelter is well supported. Check all bolts and nuts as well as all connection points to make sure they are all in good position. Check the base plates, adjust the ropes and tie downs if required and clean the cover regularly.

Snow accumulating on the fabric cover must be removed as soon as possible. If snow becomes solid ice on the cover, it will increase the weight on the roof and may collapse the shelter or reduce the life span.

Keep the shelter on a dry ground most of the time. Do not keep the fabric dirt skirt under water all the time, otherwise the fabric will deteriorate.

We strongly recommend you remove any snow from the roof immediately. Do not leave any snow load on the roof overnight. Keep 3 feet of clearance on all sides at all times. Do not allow snow to accumulate and pile up on the sides of the building. Otherwise the pressure from the sides will push inwards and could lead to a collapse.