

MODEL TMG-MSC2030

20' x 30' METAL GARAGE CARPORT SHED

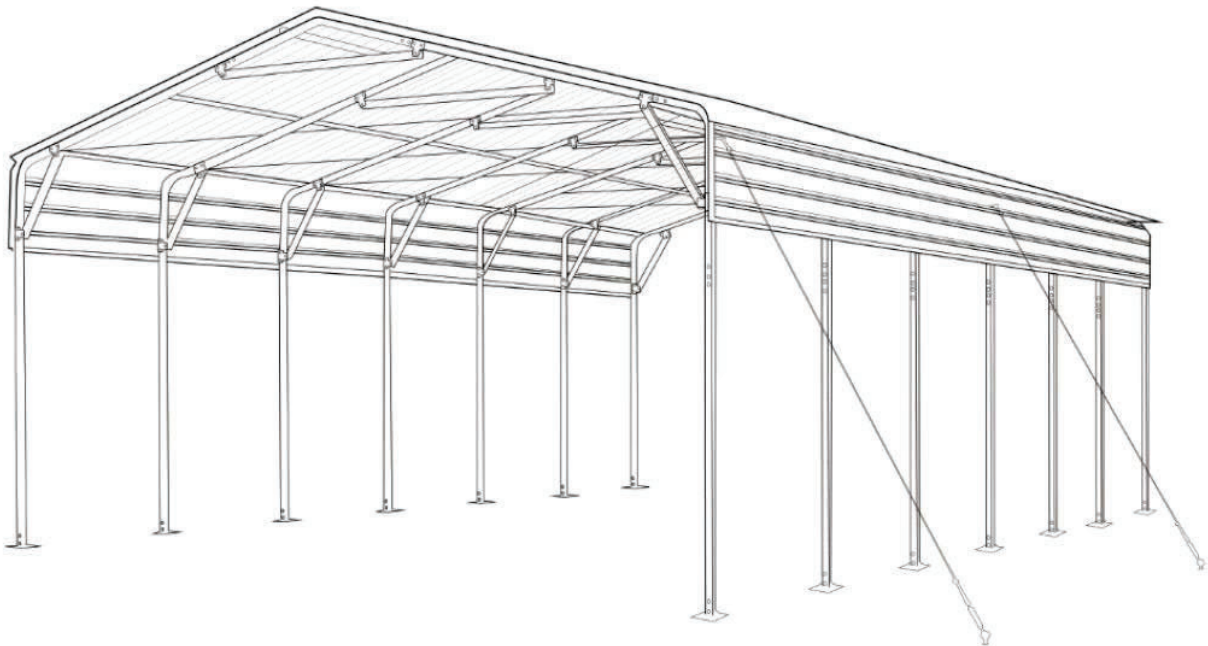

⚠ WARNING

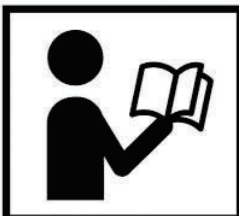

- Please read and understand the product manual completely before assembly
- Check against the parts list to make sure all parts are received
- Wear proper safety goggles or other protective gears while in assembly
- Do not return the product to dealer. They are not equipped to handle your requests.

Missing parts or have questions on assembly?

Please call: 1-877-761-2819 or email: cs@tmgindustrial.com

Main specifications :

- Assembly size : W6 x L9 x H3.8 (m) / 19.7 x 29.5 x 12.5 (ft)
- Width : 6m / 19.7 ft
- Length : 9m / 29.5 ft
- Ridge Peak Height : 3.8 m / 12.5 ft
- Shoulder height : 2.9 m / 9.5ft

Prior to assembly

Please read the instructions carefully before installation. It is very important to follow your local safety regulations and industry standards during installation. Regulations may include but are not limited to:

- Safety helmets, protective eyewear, and clothing
- Safety harnesses for all elevated workers
- Proper ladder, cage, and safety operation

Check all components and parts before installation. All parts are marked with a part number, please refer to the parts list to ensure you have all parts.









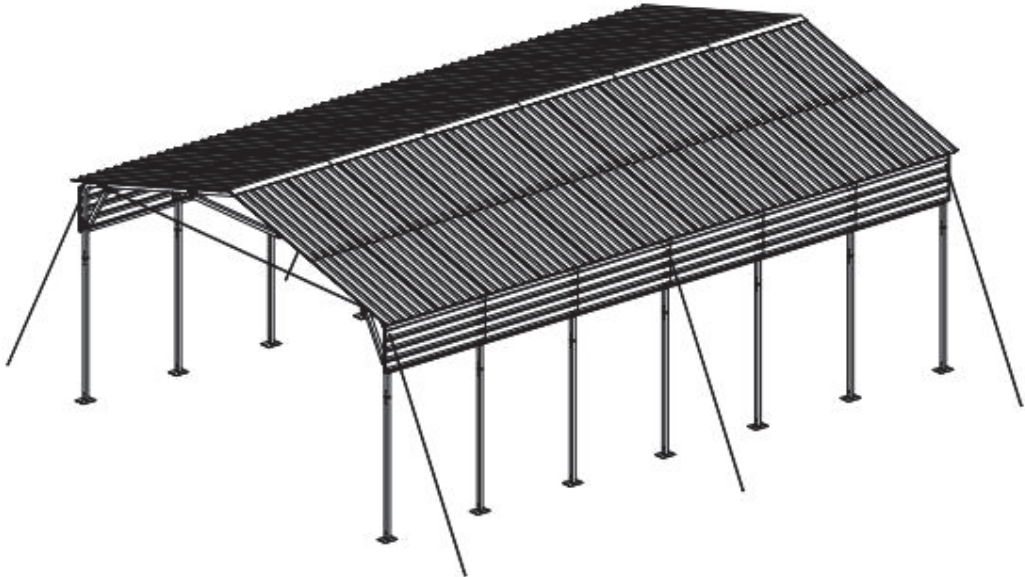
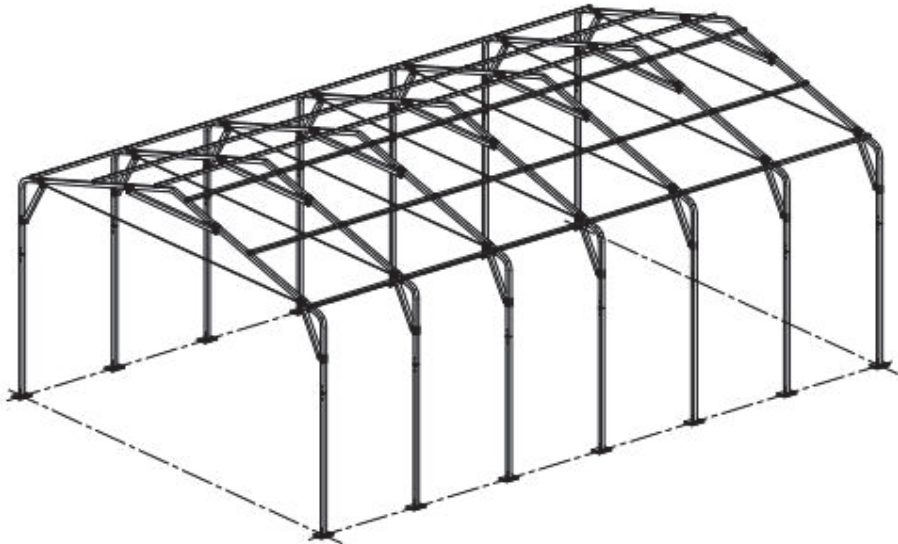

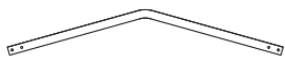





Choose a day with low or no wind to install, it is hard to assemble with heavy wind. Do not make any alterations to the structure. Do not hang any weight on the frame during installation, including parts. We are not responsible for any damages or injuries caused by inappropriate installation, unauthorized modifications or extreme weather.













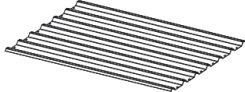



This building is not intended for human occupancy.

Check the parts list below to make sure all parts are received prior to assembly.

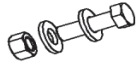
Frame structure diagram

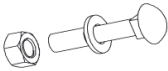
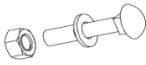

TMG-MSC2030 Part List				
Parts Code	Graphical	Description	Length	Qty
1		Peak arch tube	L1668mm	7
2		Middle rafter tube	L1880mm	14
3		Shoulder tube	L1188mm	8
3A		Shoulder tube	L1188mm	6
4		Sidewall tube	L1924mm	14
4A		Short casing	L198mm	42
5		Baseplate	W150xL200mm	14
5A		Side edge crossbar (front and rear truss)	L1570mm	4
5B		Side edge crossbar (middle truss)	L1500mm	8
5C		Top cross bar A	L1500mm	30
5D		Top cross bar B	L1550mm	6
6		Ceiling cross bar	L1763mm	7
6A		Metal sheet	W870xL1680mm	44
6C		Short casing	L100mm	30
6D		Reinforcing tube	L740mm	14
6E		Reinforced tube mounting plate	L100mm	56

6F		Reinforced tube mounting plate	L100mm	28
7		Metal sheet	W870xL1620mm	4
8		Metal sheet	W870xL1600mm	8
9		Edge protector	L600mm	4
11		Edge protector(top)	L1600mm	6
12		Eyebolt	M10x90mm	6
13		Anchor hook	φ16x120mm	6
14		Steel cable	L3.9m	6
14A		Steel cable	L5m	7
15		Expansion bolt	φ16 x 150mm	28
16		Drill	φ3.5mm	2
17		Hex bolt	M10x70mm	266
18		Self tapping screw	#12x30mm	344
19		Blind rivet	φ3x10mm	72
20		Corner protector		4
21		Self locking bolt and nuts	M10x100mm	42
21A		Self locking bolt and nuts	M10x50mm	30
22		Sleeve	φ8mm	2
23		Square plug	35x35mm	12

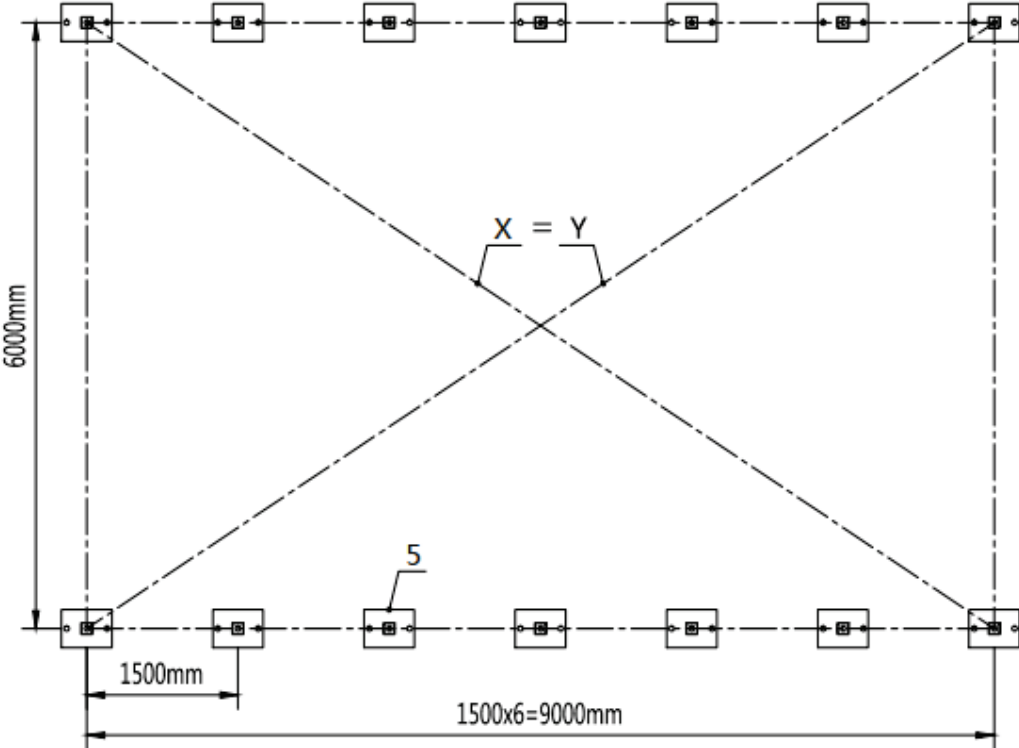

Step 1 : Baseplate positioning and installation.

- The diagonal X and Y must be equal.

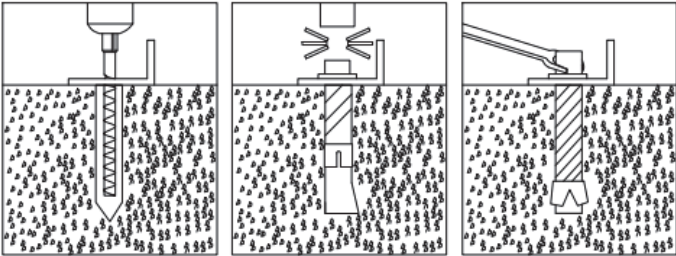

- Installation diagram of expansion bolt.



No.	Part	Qty
5		14
15		28

Step 2 : Install all trusses.

- Install front, rear and middle trusses.

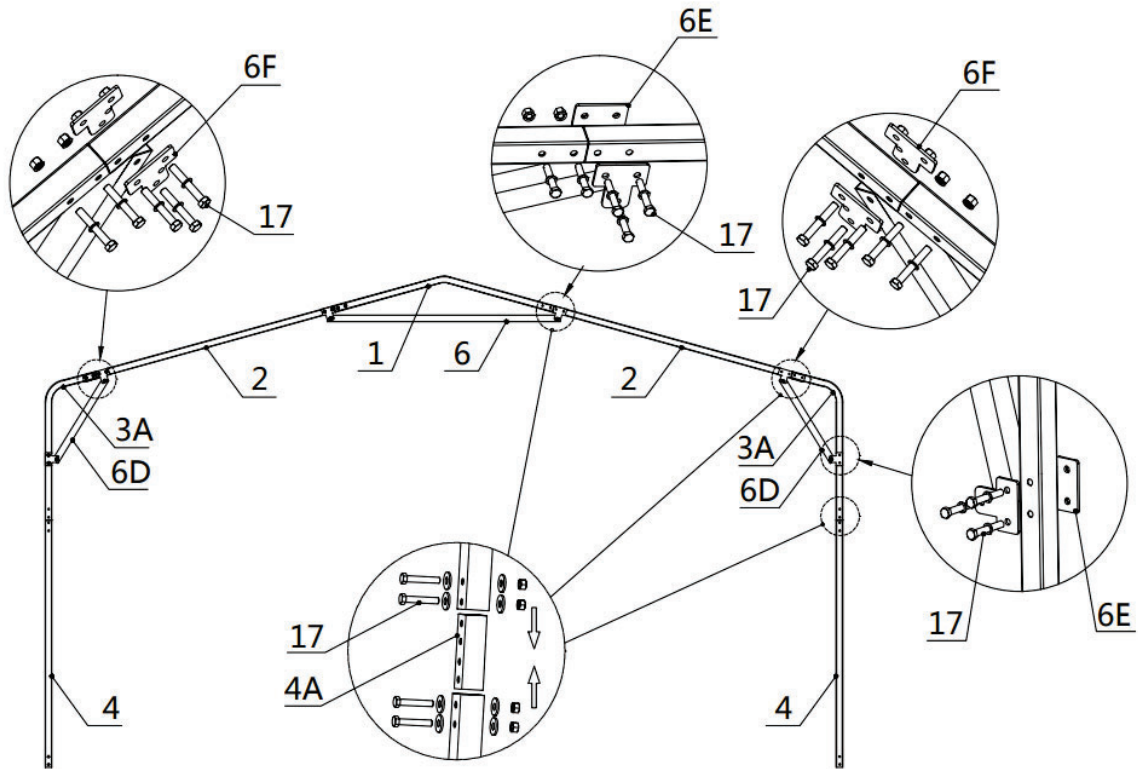

No.	Part	Qty
1		1x3
2		2x3
3A		2x3
4		2x3
4A		6x3

No.	Part	Qty
6		1x3
6D		2x3
6E		8x3
6F		4x3
17		34x3

- Install other trusses.(4 trusses)

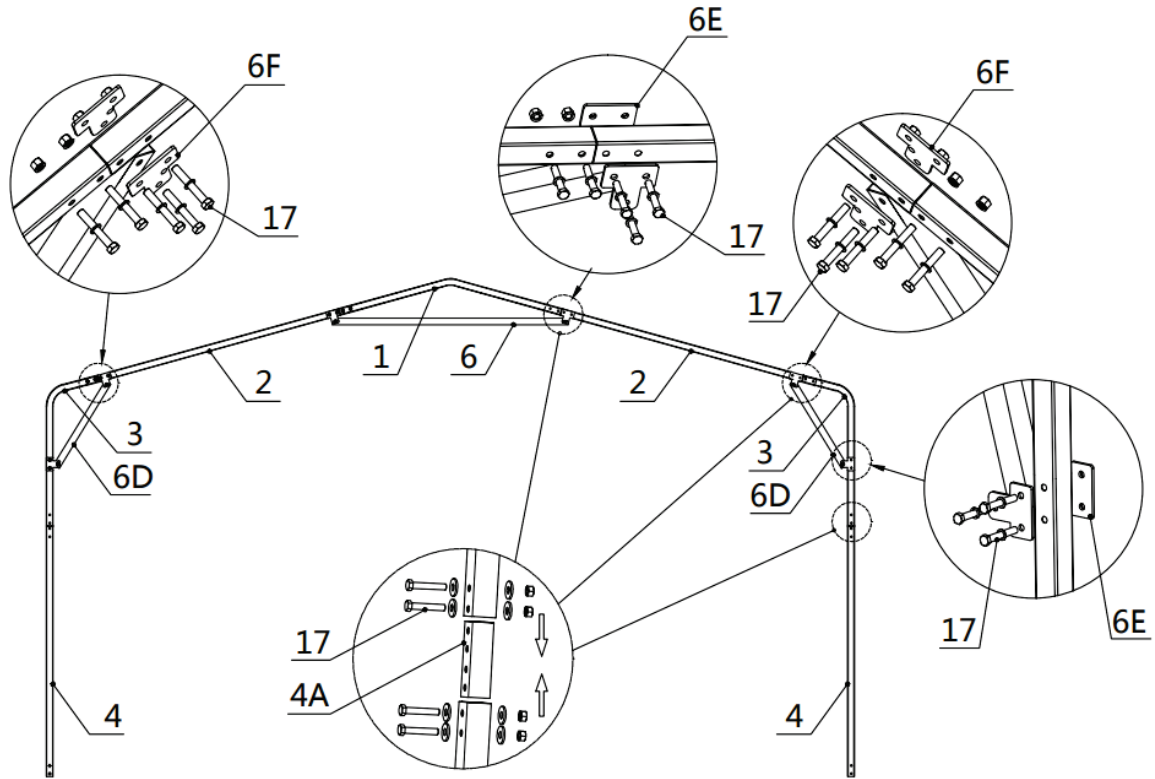

No.	Part	Qty
1		1x4
2		2x4
3		2x4
4		2x4
4A		6x4

No.	Part	Qty
6		1x4
6D		2x4
6E		8x4
6F		4x4
17		34x4

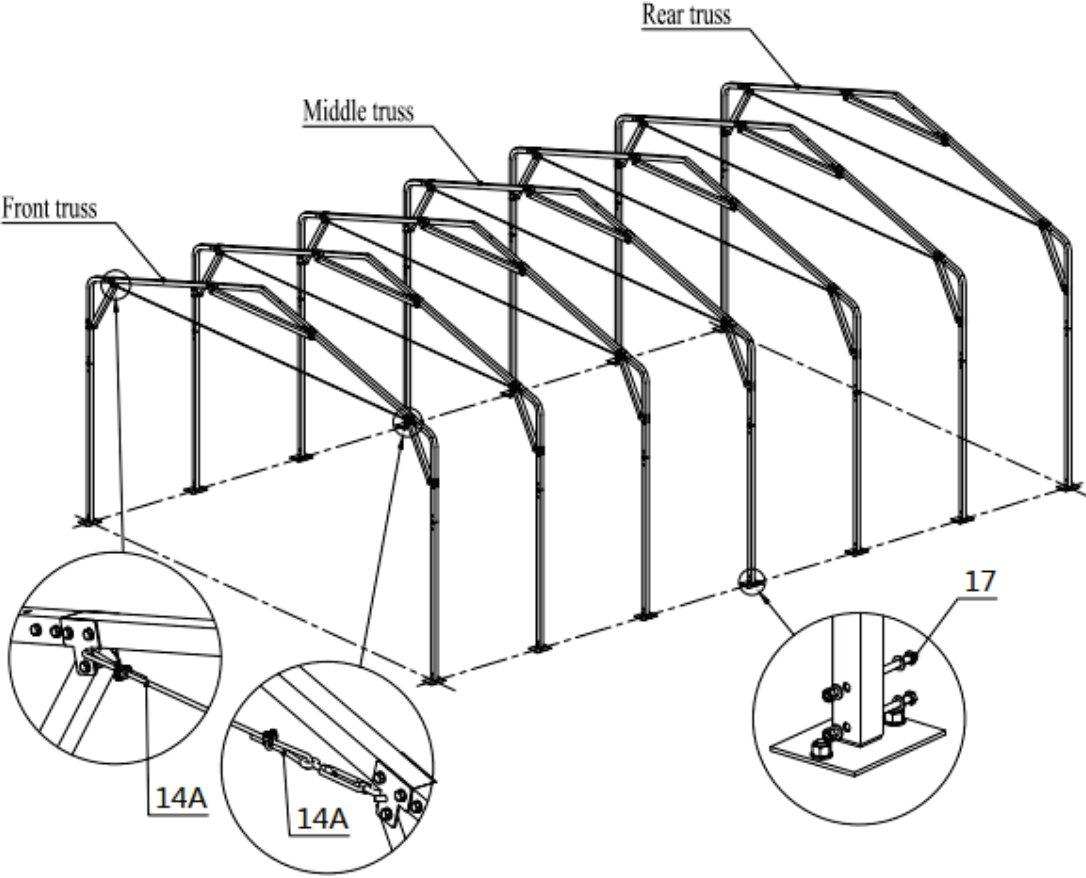

Step 3 : Put up the all trusses, install the wire rope.

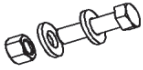

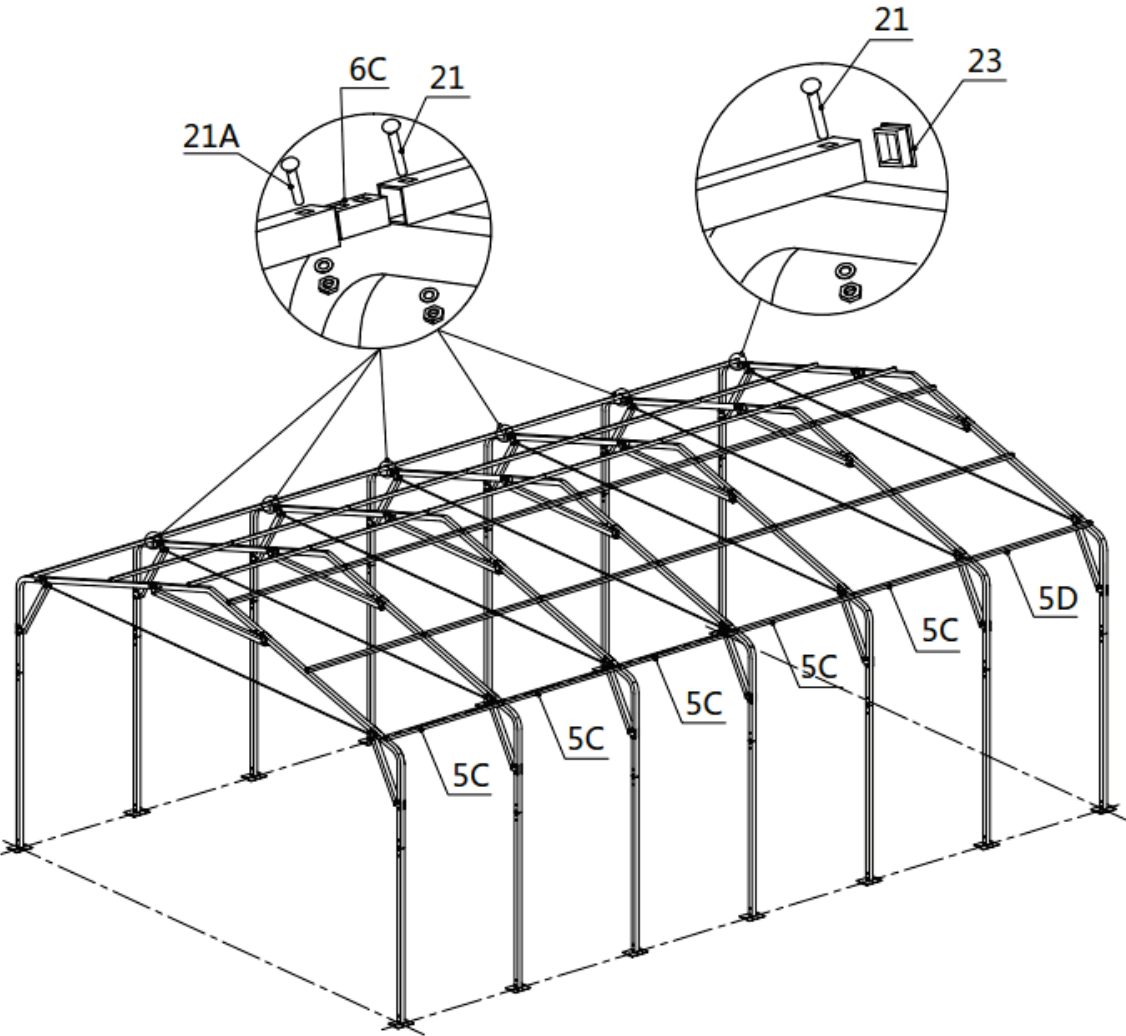

No.	Part	Qty
14A		7
17		28

Step 4 : Install top cross bar.

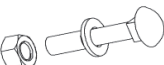
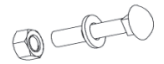

No.	Part	Qty
5C		30
5D		6
6C		30

No.	Part	Qty
21		42
21A		30
23		12

Step 5 : Install side panels.

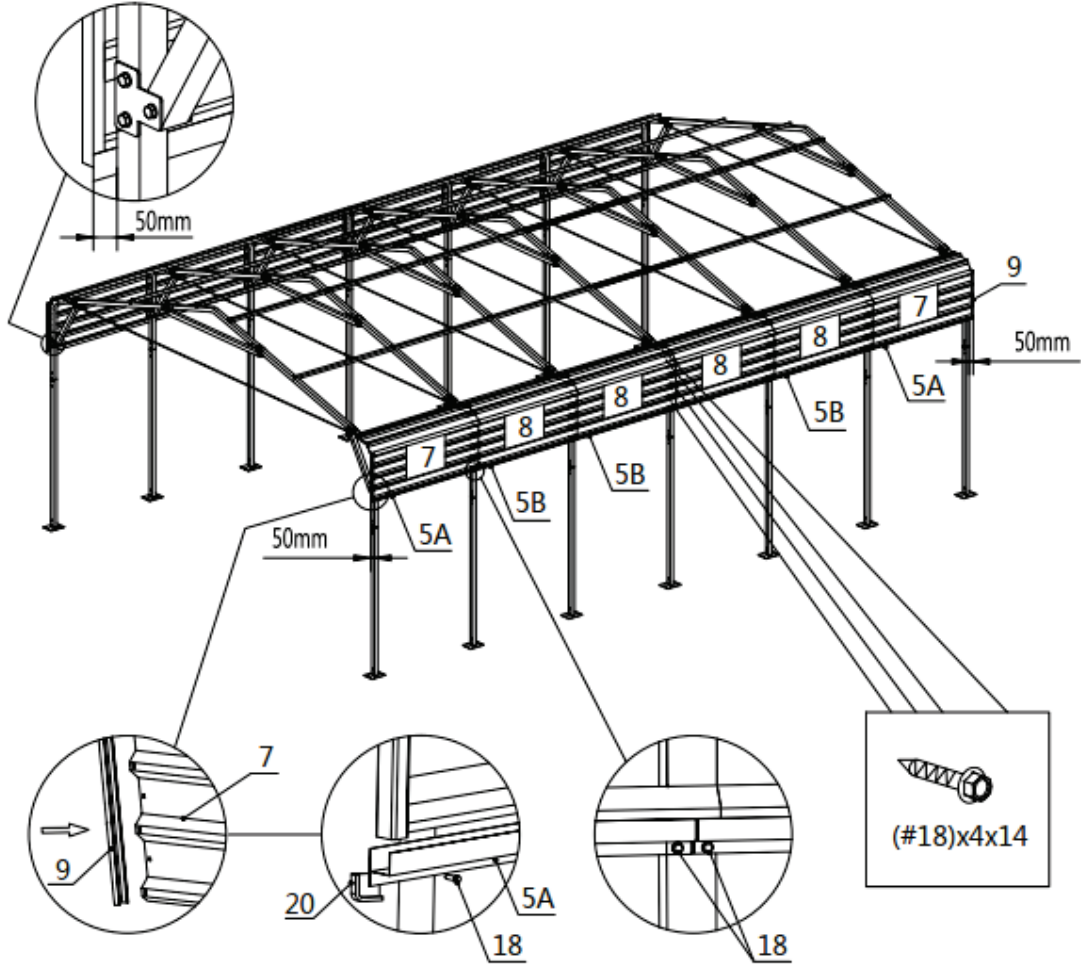



No.	Part	Qty
5A		4
5B		8
7		4
8		8

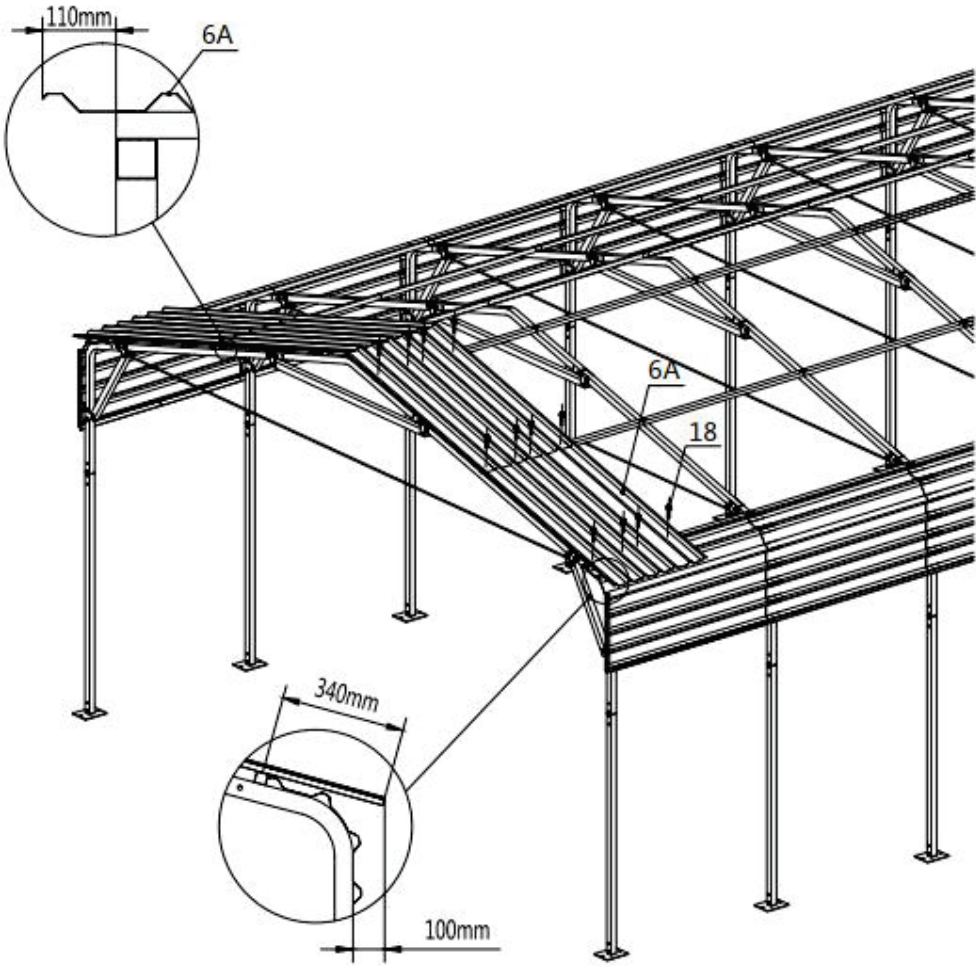

No.	Part	Qty
9		4
18		80
20		4

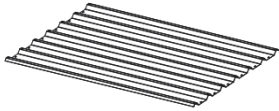

Step 6 : Install the roof panels.

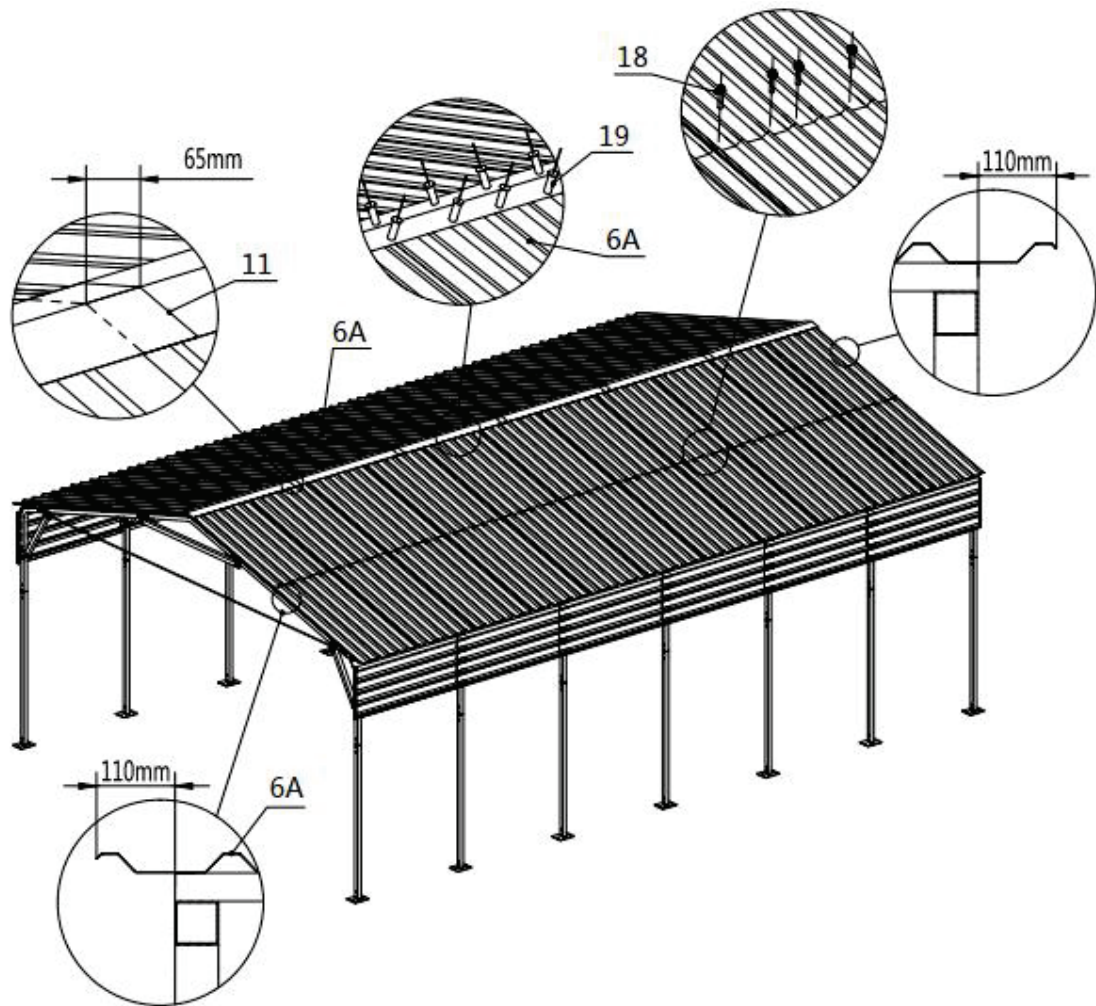

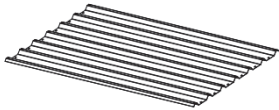
No.	Part	Qty
6A		4
18		24





No.	Part	Qty
6A		40
11		6

No.	Part	Qty
18		240
19		72

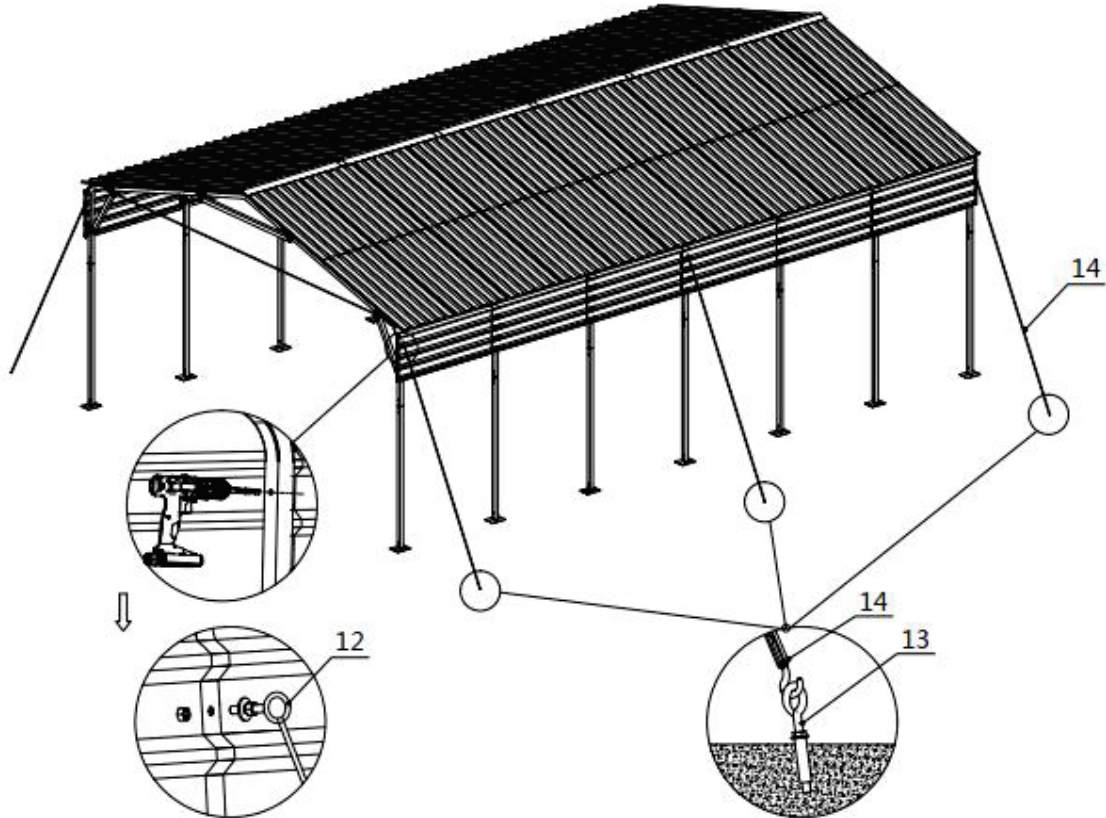
Step 7 : Install the wire rope.



No.	Part	Qty
12		6
13		6

No.	Part	Qty
14		6

After the Installation

Walk around and inspect the carport periodically to make sure all components are still firmly secured and the whole carport is well supported. Check all bolts and nuts as well as all connection points to make sure they are all in good position. Check the base plates, adjust the ropes and tie downs if required and clean the cover regularly.

Snow accumulating on the cover must be removed as soon as possible. If snow becomes solid ice on the cover, it will increase the weight on the roof and may collapse the carport or reduce the life span.

We strongly recommend you remove any snow from the roof immediately. Do not leave any snow load on the roof overnight. Keep 3 feet of clearance on all sides at all times. Do not allow snow to accumulate and pile up on the sides of the building. Otherwise the pressure from the sides will push inwards and could lead to a collapse.

ATTENTION

TO ENSURE THAT YOUR CARPORT SHED HAS BEEN SECURELY INSTALLED AND ITS WARRANTY VALIDITY, IT IS IMPORTANT TO READ THE FOLLOWING PAGES CAREFULLY.

Shoulder Support Bracing
(Reinforcing Tube)

Steel Anchor Cables

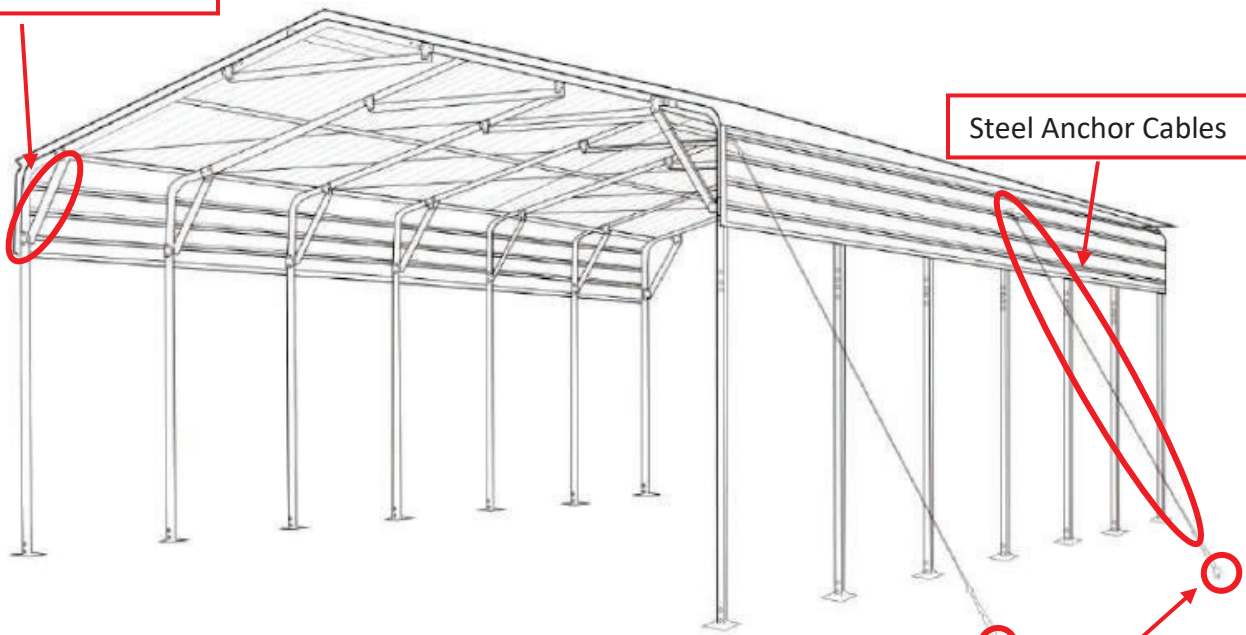

Anchor Bolts on Concrete Pads
(at least 6" thick)



As the owner of your product, it is important to take the necessary steps to ensure its stability and durability, especially in areas where heavy snow or high winds are common. Following these three steps will help prevent any damage due to snow or wind loads, and ensure that the product warranty remains valid.

1. Shoulder Support Bracing (Reinforcing Tube)

Shoulder support bracing is installed on both sides of the truss to provide additional support to the structure. This helps to distribute the weight of snow and wind loads evenly across the structure, preventing any one area from bearing too much weight. The bracing should be installed according to the manufacturer's instructions, ensuring that it is securely attached to the truss.

2. Steel Anchor Cables

Steel anchor cables are a critical component of the shed's stability, as they hold the shed firmly to the ground and prevent it from being lifted or shifted by wind or snow loads. These cables should be installed on **all four corners** of the shed and attached to the ground using suitable anchors. It is important to ensure that the cables are securely anchored to the ground, as any loosening could compromise the shed's stability.

3. Concrete Pad and Anchor Bolts

Installing the shed on a concrete pad or equivalent provides a stable foundation for the shed and helps to prevent it from shifting or settling over time. Anchor bolts should be used to secure the shed firmly to the concrete pad, ensuring that it does not move during high winds or heavy snow loads. It is important to ensure that the anchor bolts are installed according to the manufacturer's instructions and that they are tightened securely.

It is important to note that the shed is not engineered to handle snow and wind loads, and the engineering drawing is not available from the seller. Therefore, it is crucial to check the local building codes and regulations to determine if a permit is required for the installation of the shed. In some areas, a permit may be required for any type of structure, regardless of whether it is engineered to handle snow and wind loads.

If a permit is required and the shed does not meet the engineering requirements, it may not be possible to obtain a permit for its installation. In such cases, it may be necessary to either modify the shed to meet the engineering requirements or to choose a different type of structure that is designed to handle snow and wind loads. Any modifications required to meet building codes and regulations are the sole responsibility and expense of the owner.

In summary, it is important to prioritize safety and compliance with local building codes and regulations to avoid any potential safety hazards or legal issues in the future. By following these three steps, you can ensure the stability and durability of your shed and prevent any damage due to snow or wind loads. Remember, failure to follow these steps may result in the voiding of the product warranty.