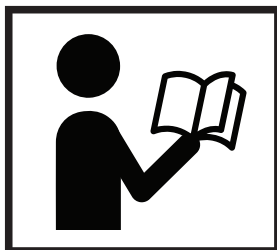

Double Garage Metal Shed

Model: TMG-MS2525
TMG-MS2533
TMG-MS2541

**⚠ WARNING**

This structure is intended for temporary outdoor storage use only. It is not designed to withstand heavy snow and wind loads and does not come with engineering drawings. To ensure suitability for your specific weather needs, it is your responsibility to verify their appropriateness for your intended use and local weather conditions, especially in areas prone to severe weather.

- Please read and understand the product manual completely before assembly
- Check against the parts list to make sure all parts are received
- Wear proper safety goggles or other protective gears while in assembly
- Do not return the product to dealer. They are not equipped to handle your requests.







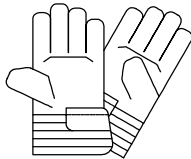

Missing parts or have questions on assembly?
Please call: 1-877-761-2819 or email: cs@tmgindustrial.com

DIRECTORY

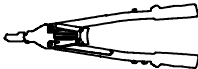
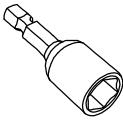
1.	BEFORE YOU START.....	3
2.	THE LAYOUT FOUNDATION(ONE).....	4
3.	THE LAYOUT FOUNDATION(TWO).....	5
4.	PART LIST.....	8
5.	INSTALLATION FRAMEWORK.....	14
6.	INSTALLATION WALL TILE.....	31
7.	DOOR ASSEMBLY.....	41
8.	INSTALLATION ROLLER DOOR(OPTIONAL).....	44
9.	INSTALLATION FRAMEWORK.....	49
10.	INSTALL TRANSPARENT PANEL.....	51

BEFORE YOU START

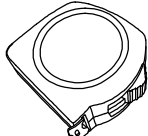
Items Required:

Tools					
	gloves	Safety Glasses	Shoes	Riveting Gun	Sleeve
Tools					
	Power drill	Screw driver	Pencil	Tape Measure	Ladder

- Clear a working area to allow access on 4 sides. A raised work surface will make assembly easier.
- Please choose a dry and calm day to start assembly. Do not attempt installation in rainy or windy day.
- **Keep roof clear of leaves and snow with long handled, soft-bristled broom. Heavy amounts to snow on roof can damage building, making it unsafe to enter.**
- All parts are identified so when working through the instructions page by page the diagrams show where each part is positioned.
- Before starting, to avoid any accidental injury, we recommend the use of gloves to protect your hands, safety glasses to protect your eyes and shoes or boots to protect your feet.
- Please keep children away from your construction site.
- Most assembly can be completed by one person, assistance may be needed when you reach the erection stage.
- Cleaning should be performed as often as is required to remove any dirt, salt, and pollutants.
- Please note: Some local government authorities have rules & regulations on shed installation and you may need approval to erect this shed.

STEPS:

1. When completed place shed in position and anchor securely to the ground.
2. Clean up all metal pieces, rivets and screws.

THE LAYOUT OF FOUNDATION(ONE)

Unit:mm

Depth of cement

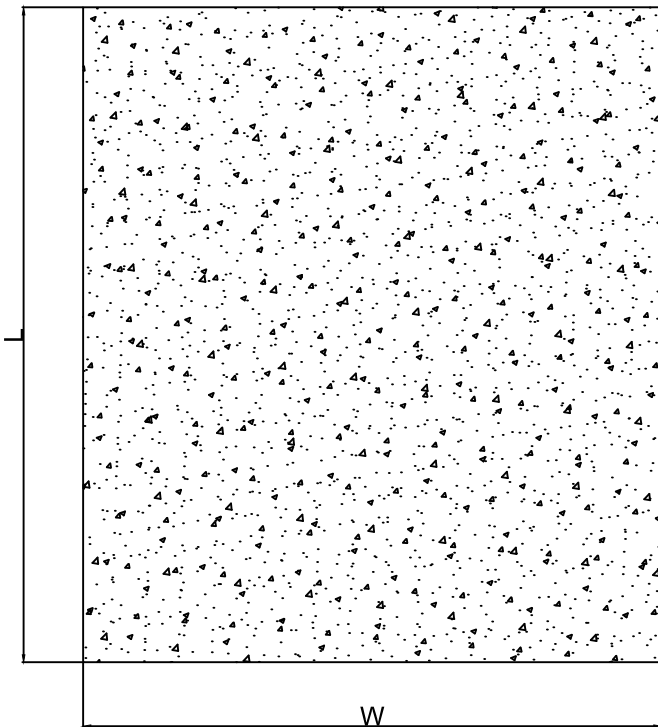
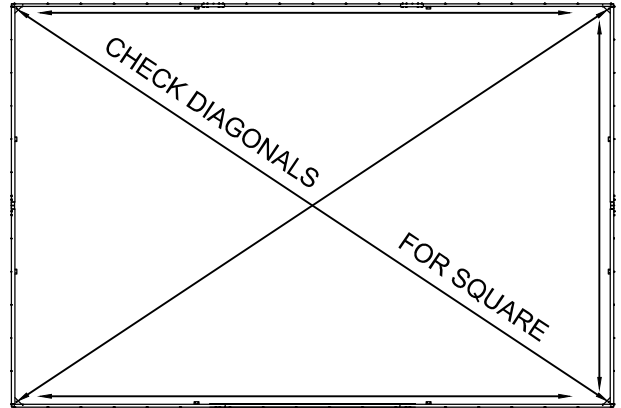
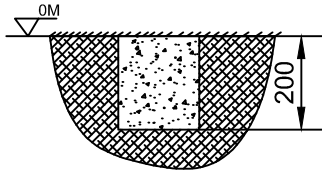

MODEL	L	W
MS2525	7610	7618
MS2533	7610	10105
MS2541	7610	12592

THE LAYOUT OF FOUNDATION(TWO)

Depth of cement

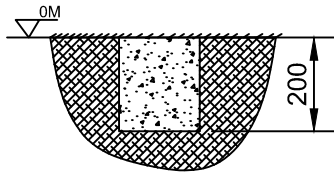

Note:the ground anchor is installed on the cement block.

Back

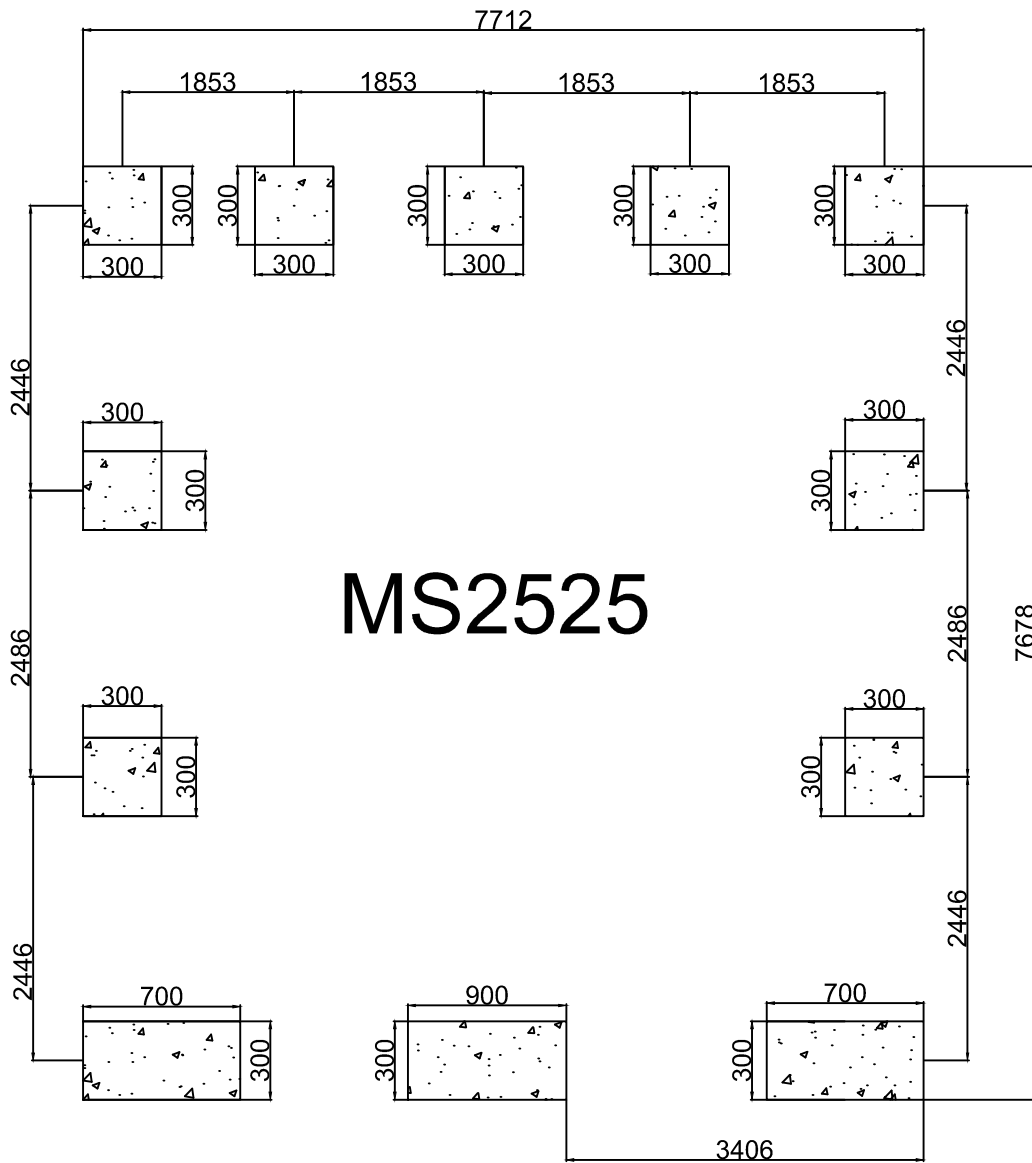

Front

THE LAYOUT OF FOUNDATION(TWO)

Depth of cement

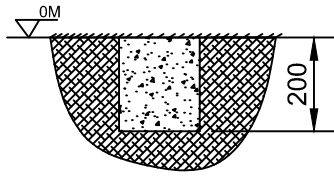

Note:the ground anchor is installed on the cement block.

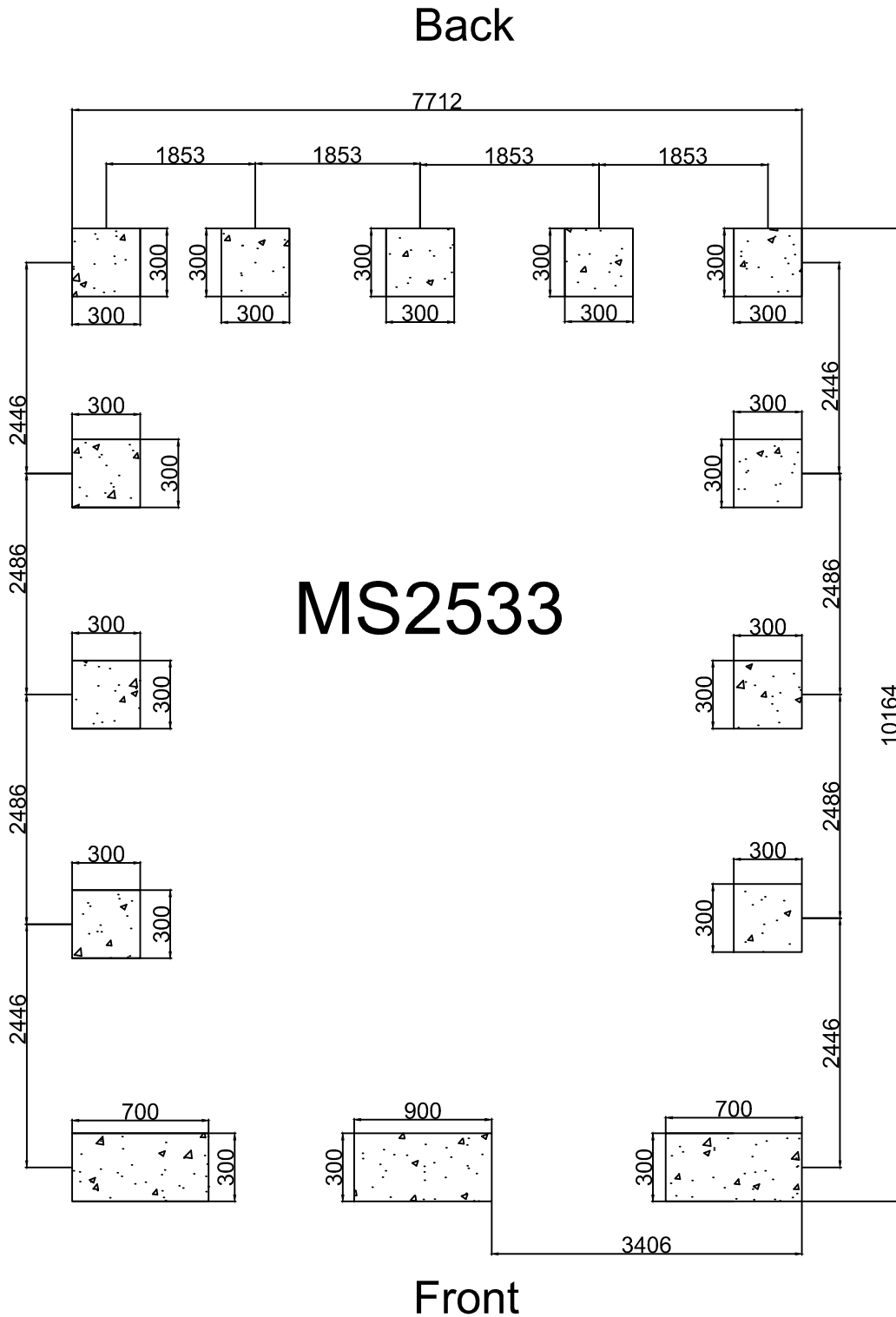

THE LAYOUT OF FOUNDATION(TWO)



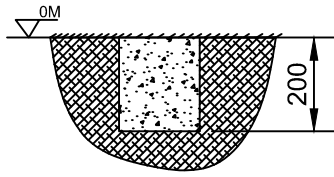



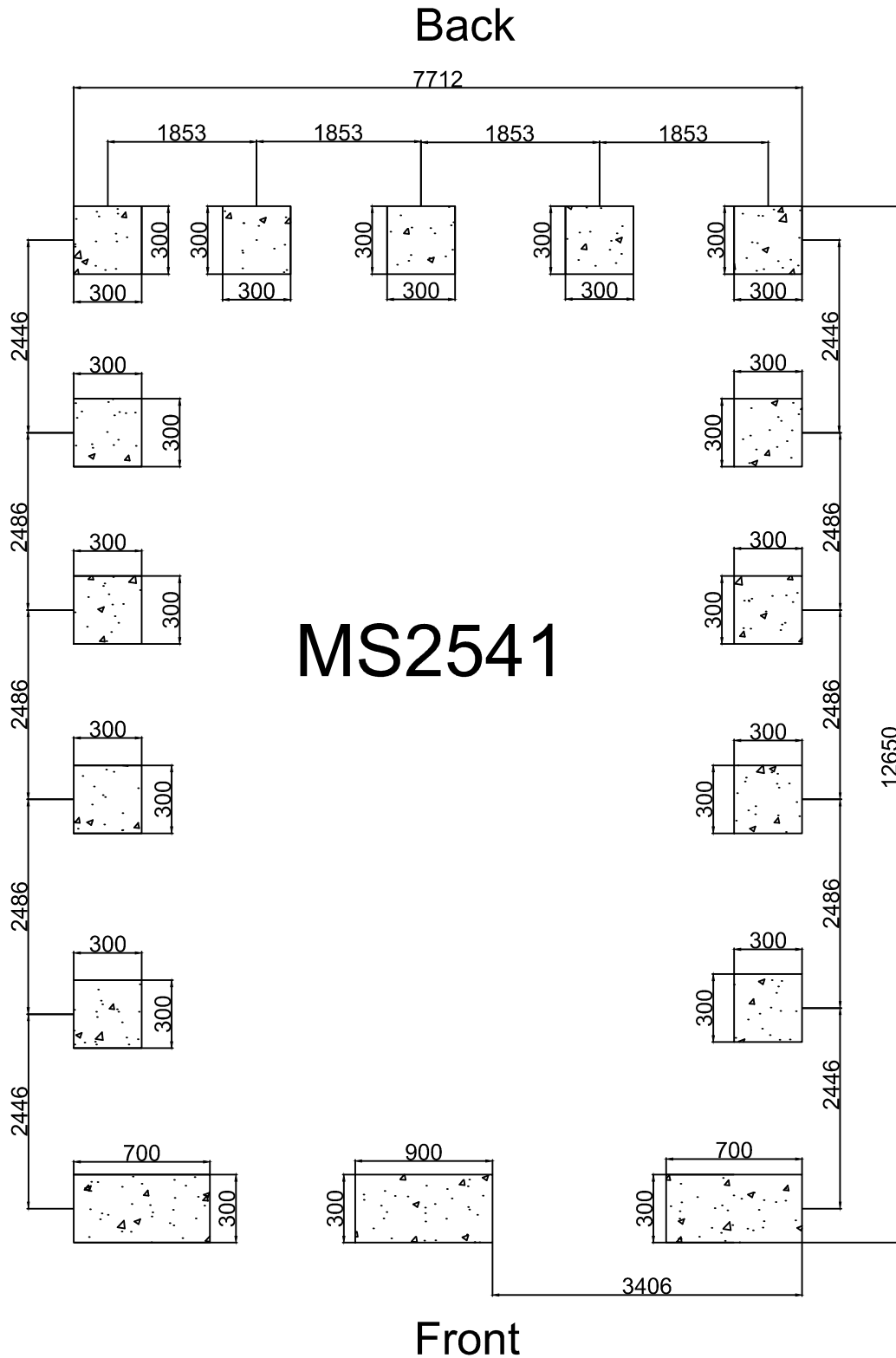









Depth of cement



















Note:the ground anchor is installed on the cement block.







PART LIST

No.	Picture	Part No.	Qty		
			MS2525	MS2533	MS2541
1		P1550	38	50	62
2		P1550-1	1		
3		P1550-2	4		
4		P1550-3	1		
5		P1390	9		
6		P1390-1	1		
7		P1050	1		
8		P1050-1	1		
9		P1830	18	24	30
10		P2180	18	24	30
11		PD1	1		
12		PF1550	2		
13		PF1390	2		
14		PL432	1		
15		PL656	1		
16		PL880	1		





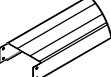
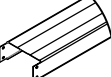
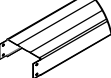
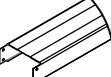
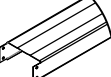
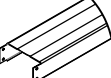
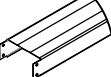
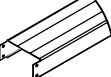
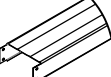
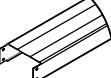
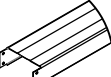
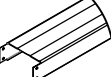





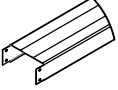

PART LIST

No.	Picture	Part No.	Qty		
			MS2525	MS2533	MS2541
17		PL1104		1	
18		P1210		1	
19		PR1104		1	
20		PR880		1	
21		PR656		1	
22		PR432		1	
23		PL692		1	
24		PL916		1	
25		PL1140		1	
26		PL1364		1	
27		P1470		1	
28		PR1364		1	
29		PR1140		1	
30		PR916		1	
31		PR692		1	
32		C2968		4	

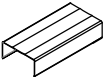

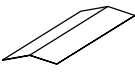
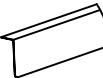







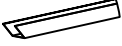
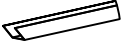
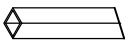

PART LIST

No.	Picture	Part No.	Qty		
			MS2525	MS2533	MS2541
33		C2900	16	20	24
34		C2090	4		
35		C1370	2		
36		C1890	2		
37		C2862	2		
38		C1851	14		
39		C2420	11		
40		C2484-1	6	12	18
41		C773	1		
42		C719	1		
43		C924	1		
44		C502	4		
45		C369	4		
46		C1852	4		
47		C1900	12	18	24
48		C1751	2	3	4



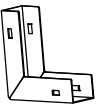



PART LIST

No.	Picture	Part No.	Qty		
			MS2525	MS2533	MS2541
49		C876	4	6	8
50		C1000-1	8		
51		C1000-2	8	12	16
52		C1924	8		
53		C1918	16	24	32
54		C1500	8	12	16
55		C600	16	24	32
56		C2484-2	30	40	50
57		C200	38	52	66
58		L800	6	8	10
59		R877	9	12	15
60		L2010	16	20	22
61		FD1	2		
62		FD2	1		
63		FD3	1		
64		FDU1	1		

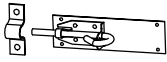
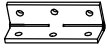

PART LIST

No.	Picture	Part No.	Qty		
			MS2525	MS2533	MS2541
65		FDU2	2		
66		U2619	4		
67		U2780	2		
68		MS1	2		
69		JA1	1		
70		JA2	2		
71		C72	21	23	25
72		S12	2830	3640	4440
73		S13	15		
74		C20	4	6	8
75		M35	2	4	4
76		C12	4		
77		L3	20		
78		L1A	6		
79		S5	20		
80		S3	28		

PART LIST

No.	Picture	Part No.	Qty		
			MS2525	MS2533	MS2541
81		H13	1		
82		SH1	2		
83		S7	24		
84		S11	21	23	25
85		C14	60	80	100
86		C73	14	20	26
87		LOGO	2		
88		UV3	2	3	3

INSTALLATION FRAMEWORK

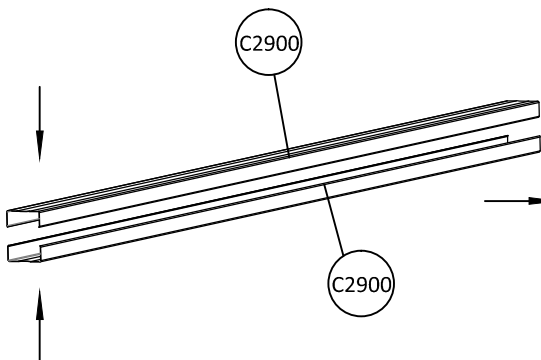

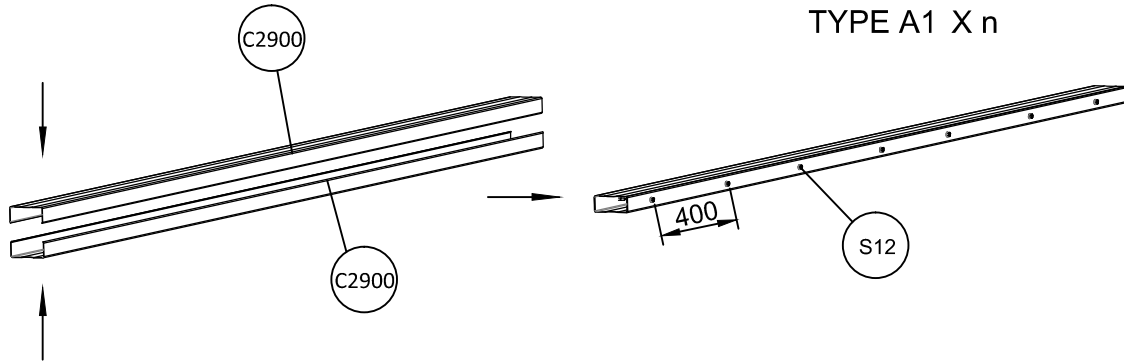
	C2900	2		S12	16	X n
						



A1	
MODEL	n
MS2525	8
MS2533	10
MS2541	12

TIPS: Select the quantity corresponding to the table for assembly according to model.



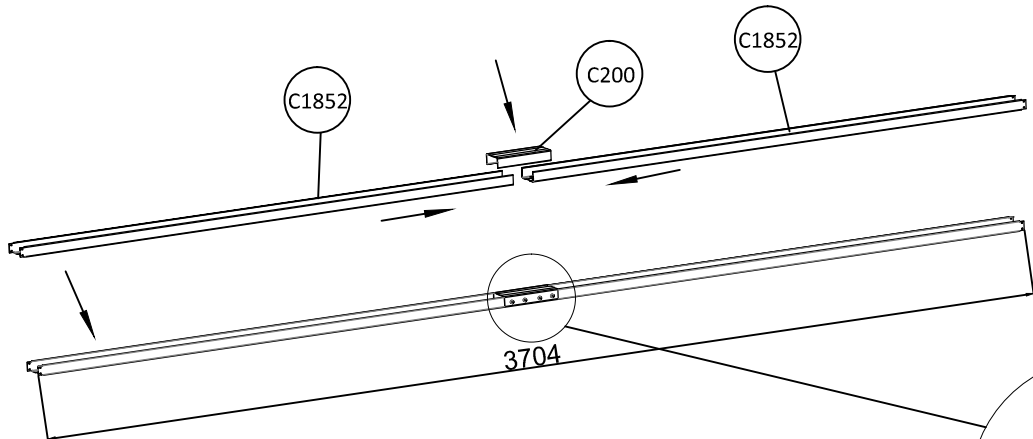

TIPS: Use labels to mark installed components for easy access.

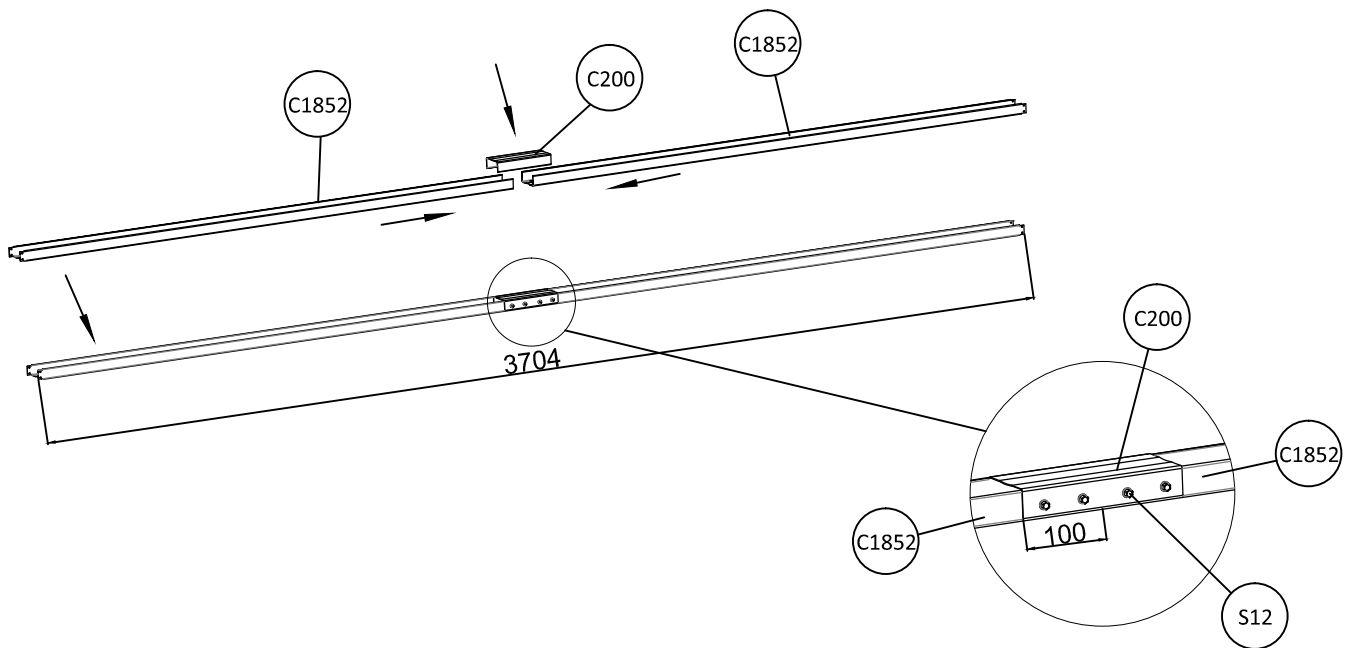
	C1852	2		C200	1		S12	8	X 2
									

TYPE A2 X 2



INSTALLATION FRAMEWORK

	C1900	6		C1751	1		C876	2		S12	38
---	-------	---	---	-------	---	---	------	---	---	-----	----

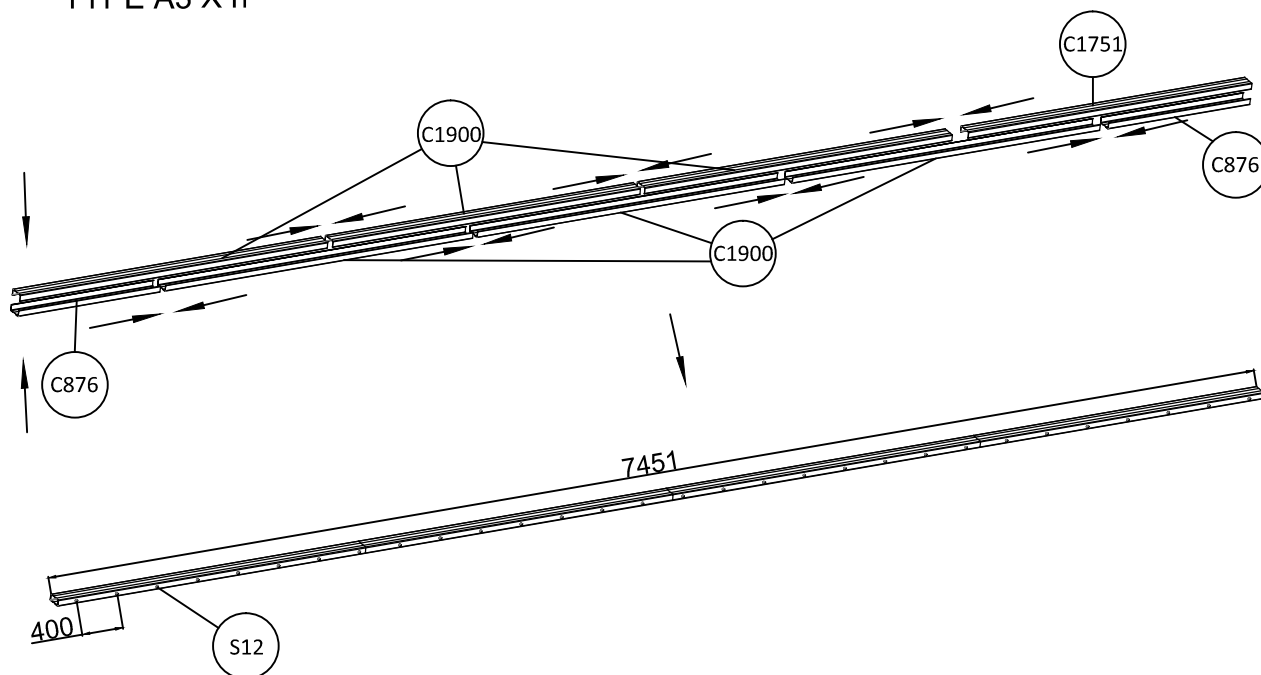

X n

TYPE A3 X n



A3	
MODEL	n
MS2525	2
MS2533	3
MS2541	4

TIPS: Select the quantity corresponding to the table for assembly according to model.

	C1000 -2	2		S12	8
--	-------------	---	---	-----	---

Xn

TYPE A4 X n

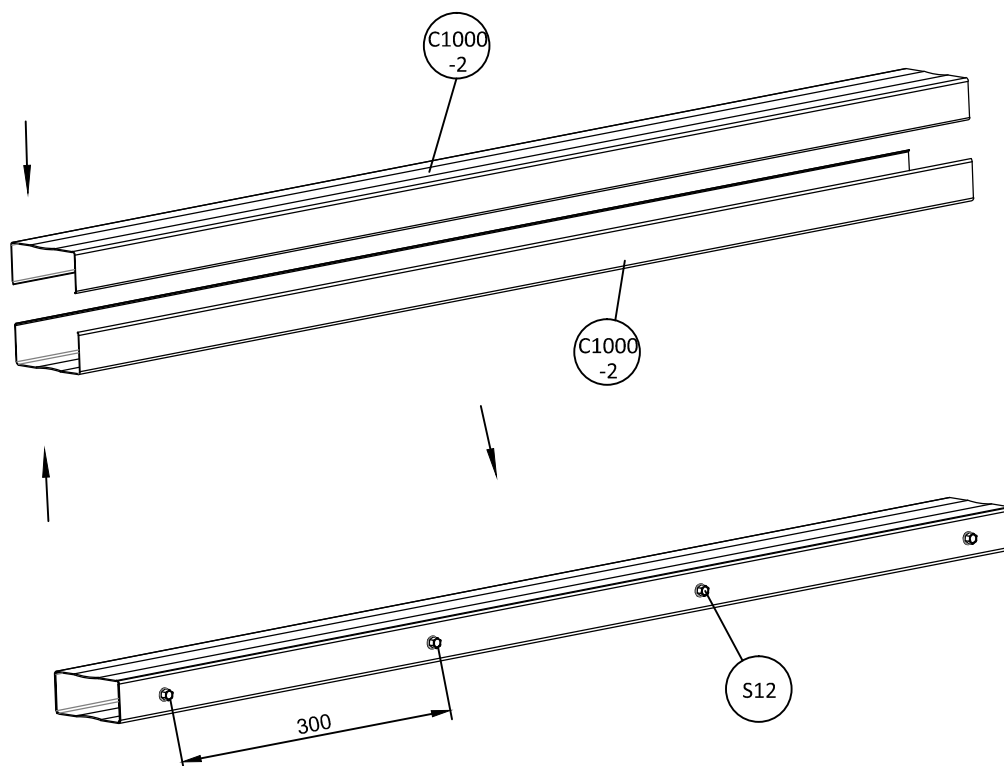

A4	
MODEL	n
MS2525	2
MS2533	3
MS2541	4

TIPS: Select the quantity corresponding to the table for assembly according to model.

INSTALLATION FRAMEWORK

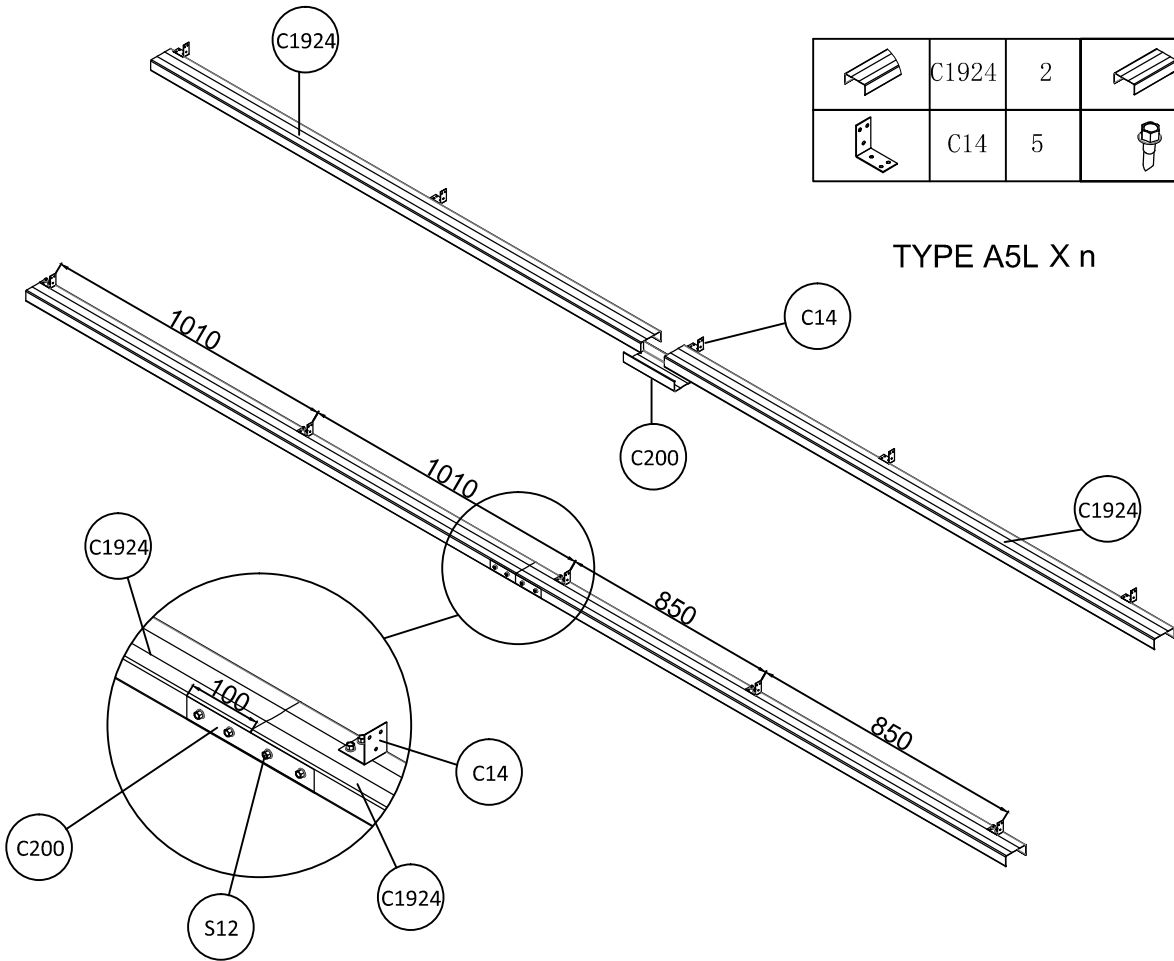

	C1924	2		C200	1
	C14	5		S12	23

X 2

TYPE A5L X n



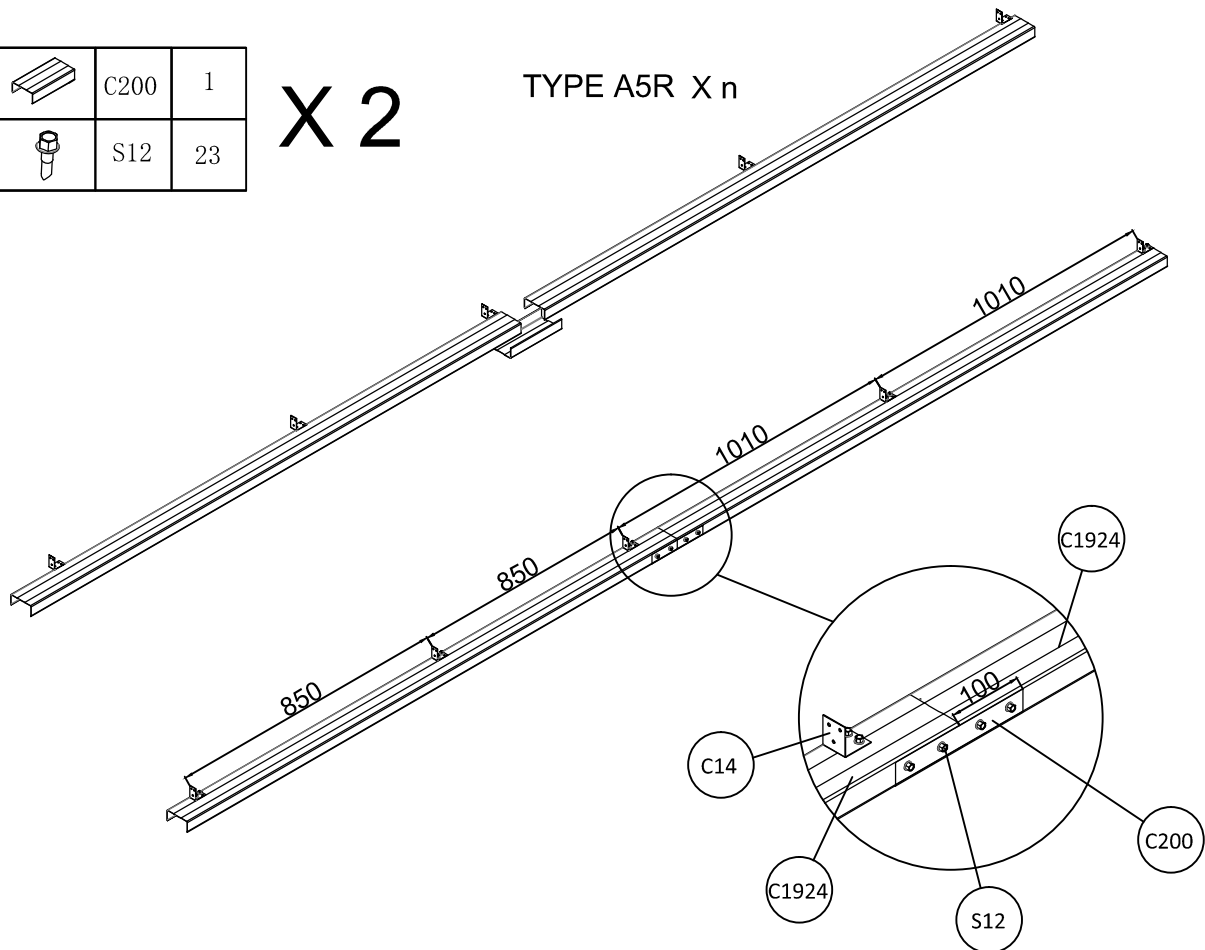

	C1924	2		C200	1
	C14	5		S12	23

X 2

TYPE A5R X n



INSTALLATION FRAMEWORK

	C1918	2		C200	1
	C14	5		S12	23



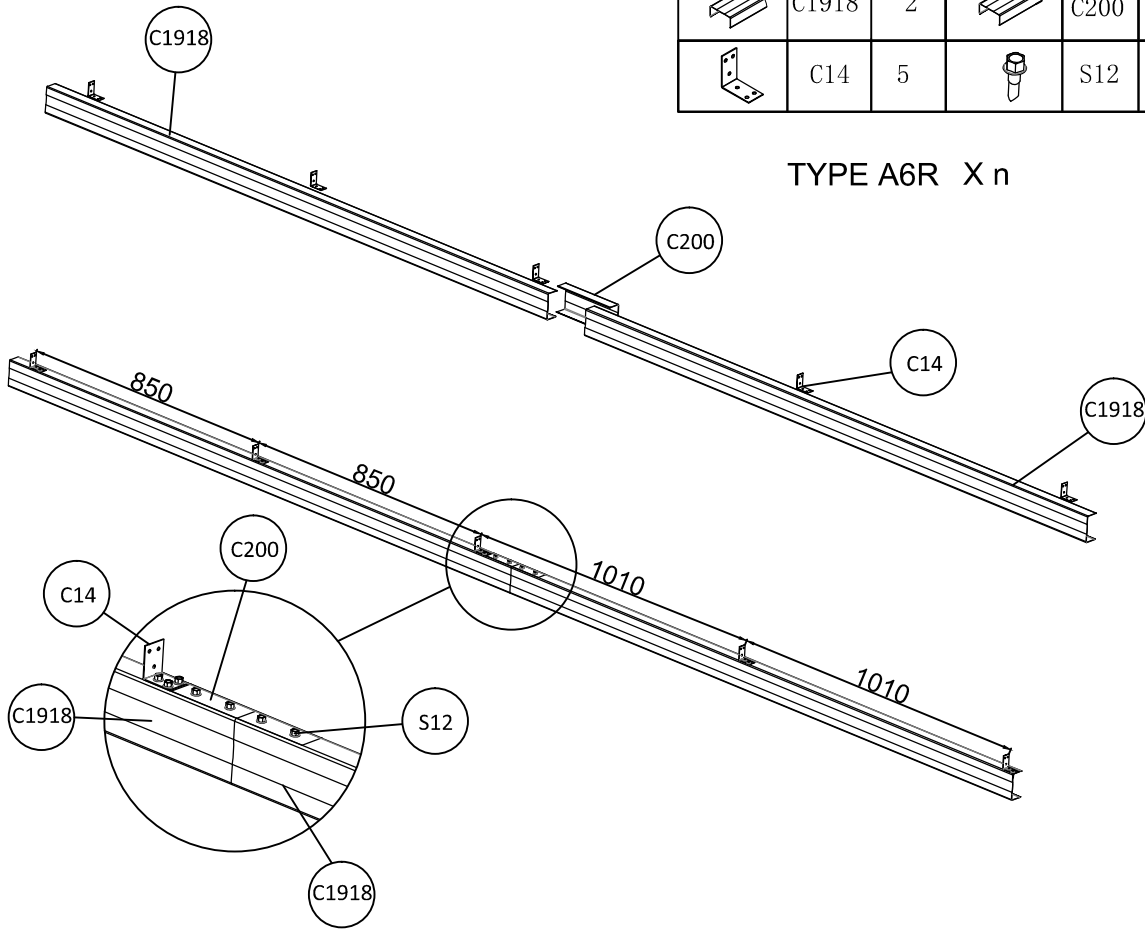

X n



TYPE A6R X n

A6R	
MODEL	n
MS2525	4
MS2533	6
MS2541	8

TIPS: Select the quantity corresponding to the table for assembly according to model.

	C1918	2		C200	1
	C14	5		S12	23

X n

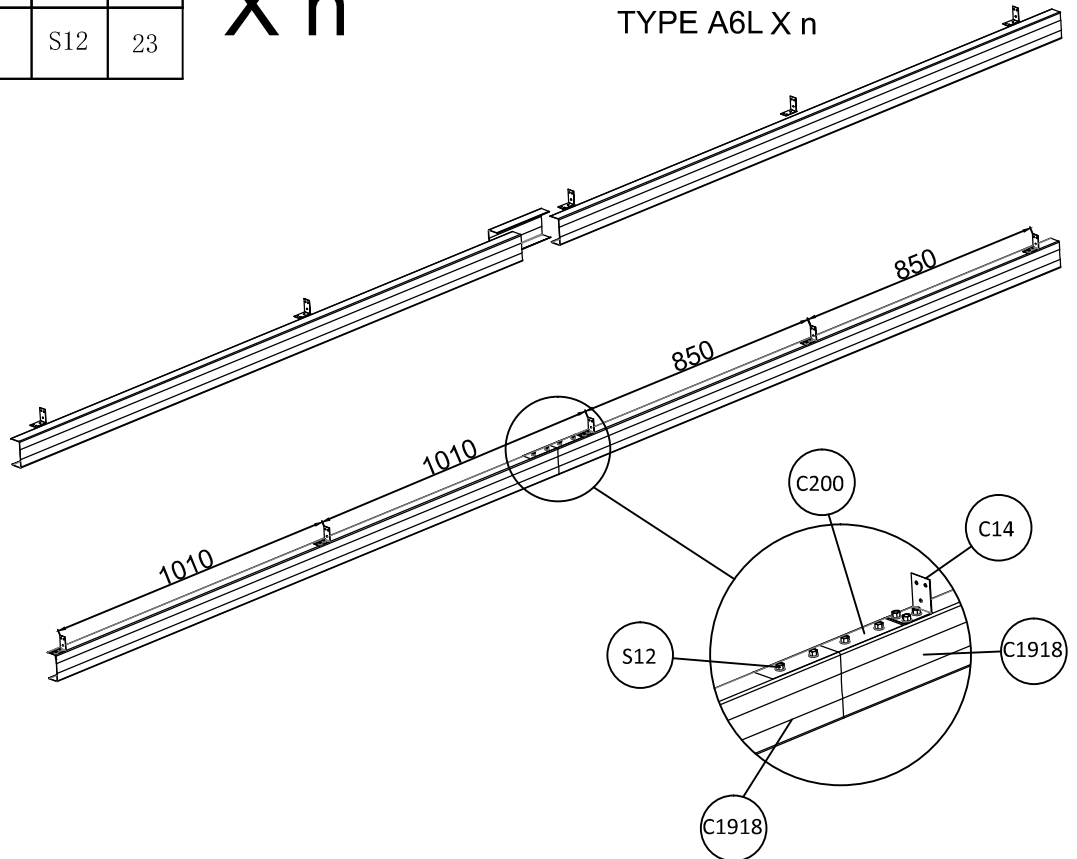

TYPE A6L X n



A6L	
MODEL	n
MS2525	4
MS2533	6
MS2541	8

TIPS: Select the quantity corresponding to the table for assembly according to model.

INSTALLATION FRAMEWORK

	C2484 -2	1		C200	1		S12	4
---	-------------	---	---	------	---	---	-----	---



X n

A7	
MODEL	n
MS2525	20
MS2533	30
MS2541	40

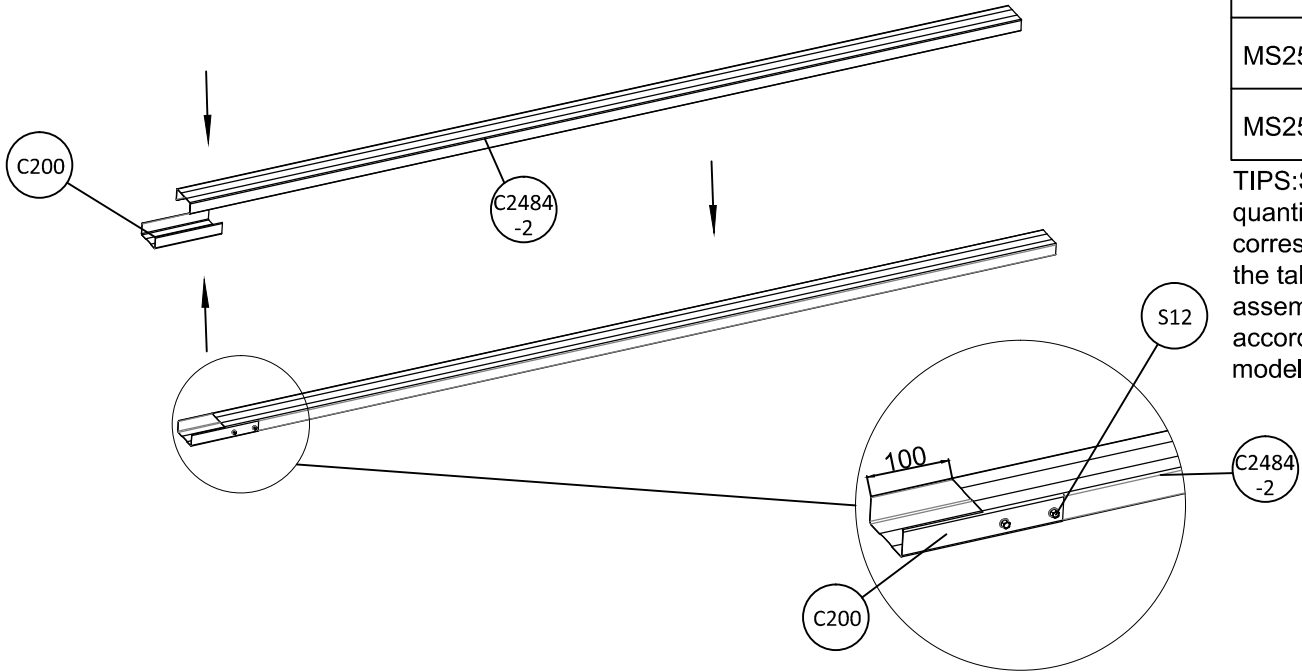
TYPE A7 X n



TIPS: Select the quantity corresponding to the table for assembly according to model.

	C1500	2		S12	12
---	-------	---	---	-----	----

X n



TYPE A8 X n

A8	
MODEL	n
MS2525	4
MS2533	6
MS2541	8

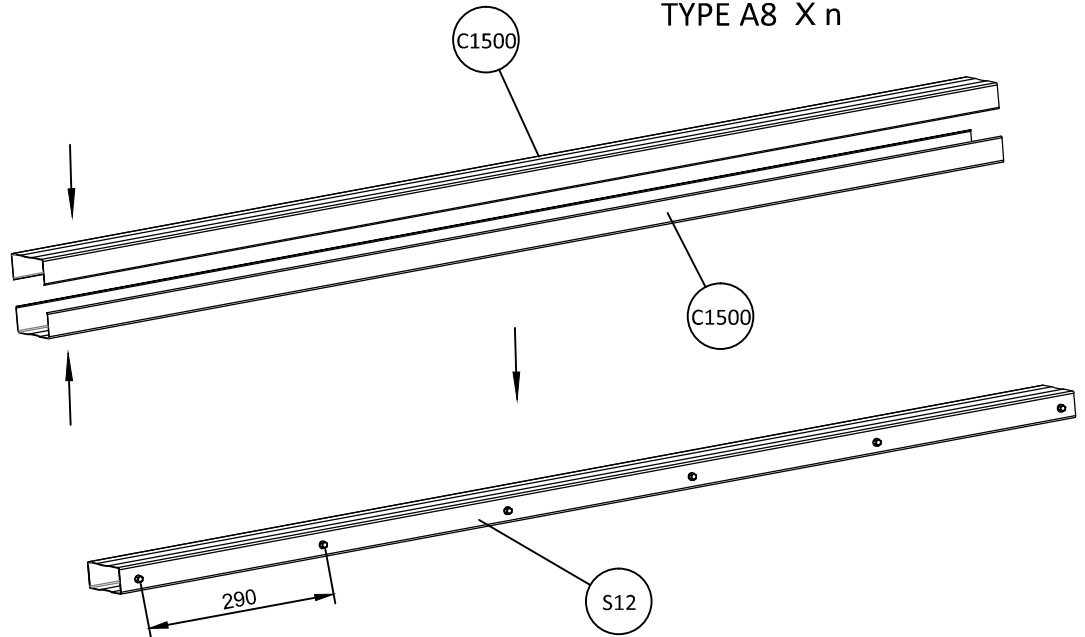
TIPS: Select the quantity corresponding to the table for assembly according to model.



INSTALLATION FRAMEWORK

	C600	2		S12	6	X n
---	------	---	---	-----	---	------------

TYPE A9 X n

A9	
MODEL	n
MS2525	8
MS2533	12
MS2541	16

TIPS: Select the quantity corresponding to the table for assembly according to model.

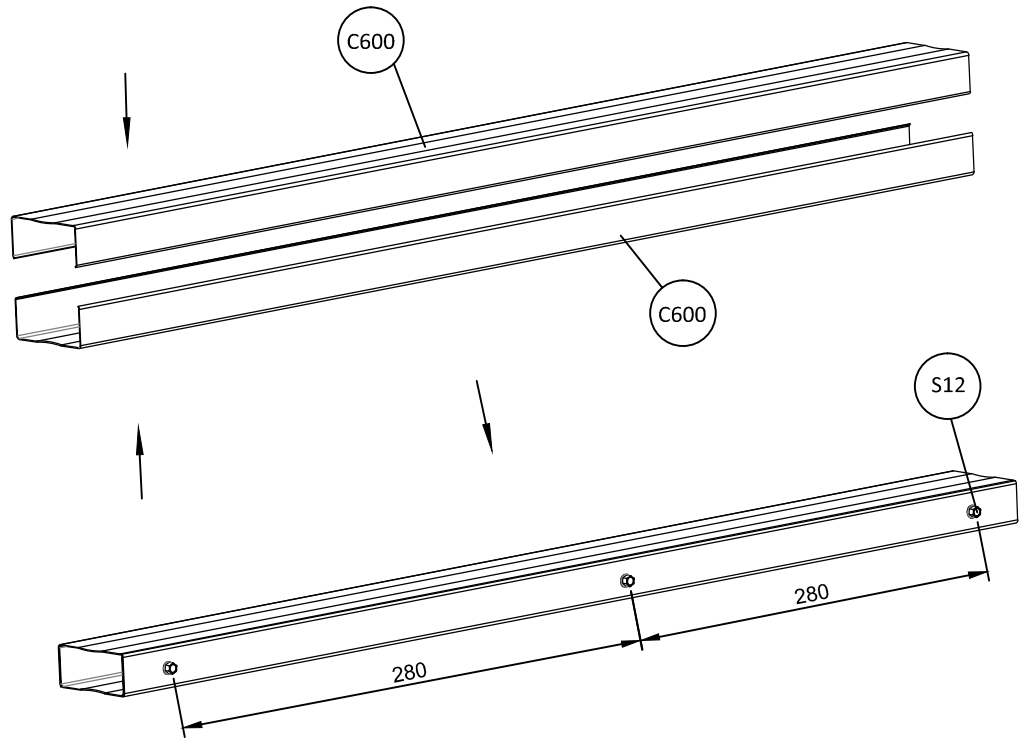





INSTALLATION FRAMEWORK





As shown in the figure draw a line before installation.

Note:

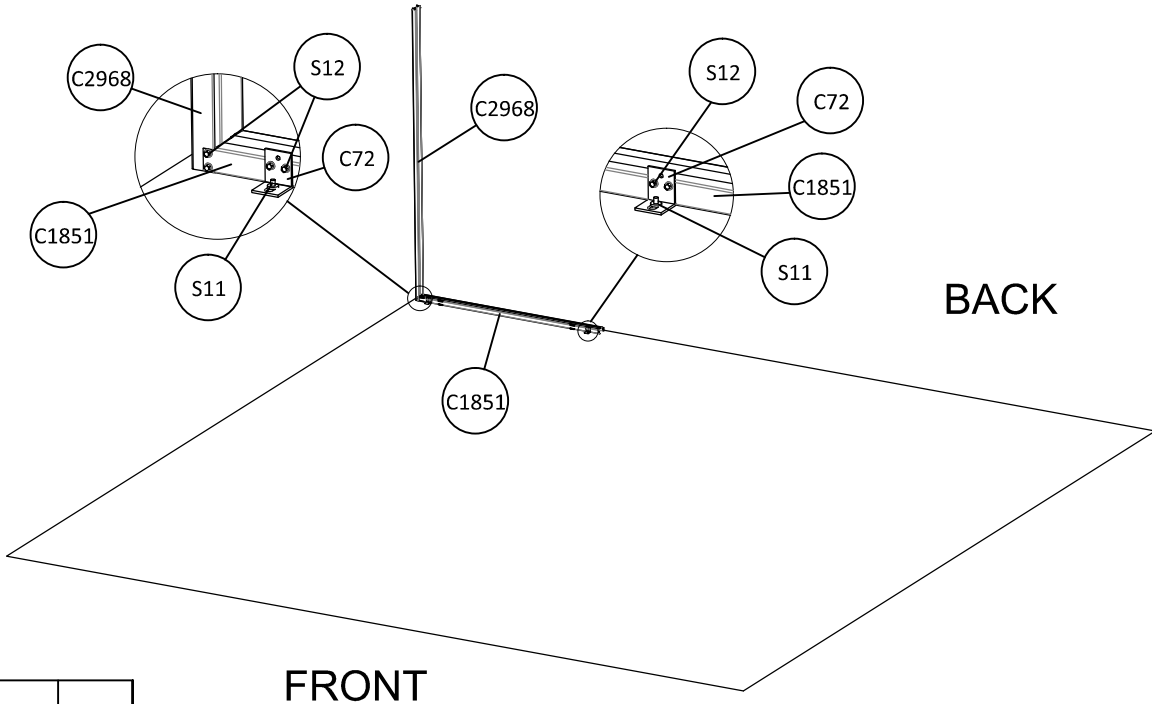
Please install the grounding part on the cement block near the column.





	C2968	1		C1851	1		C72	2
	S12	8		S11	2			

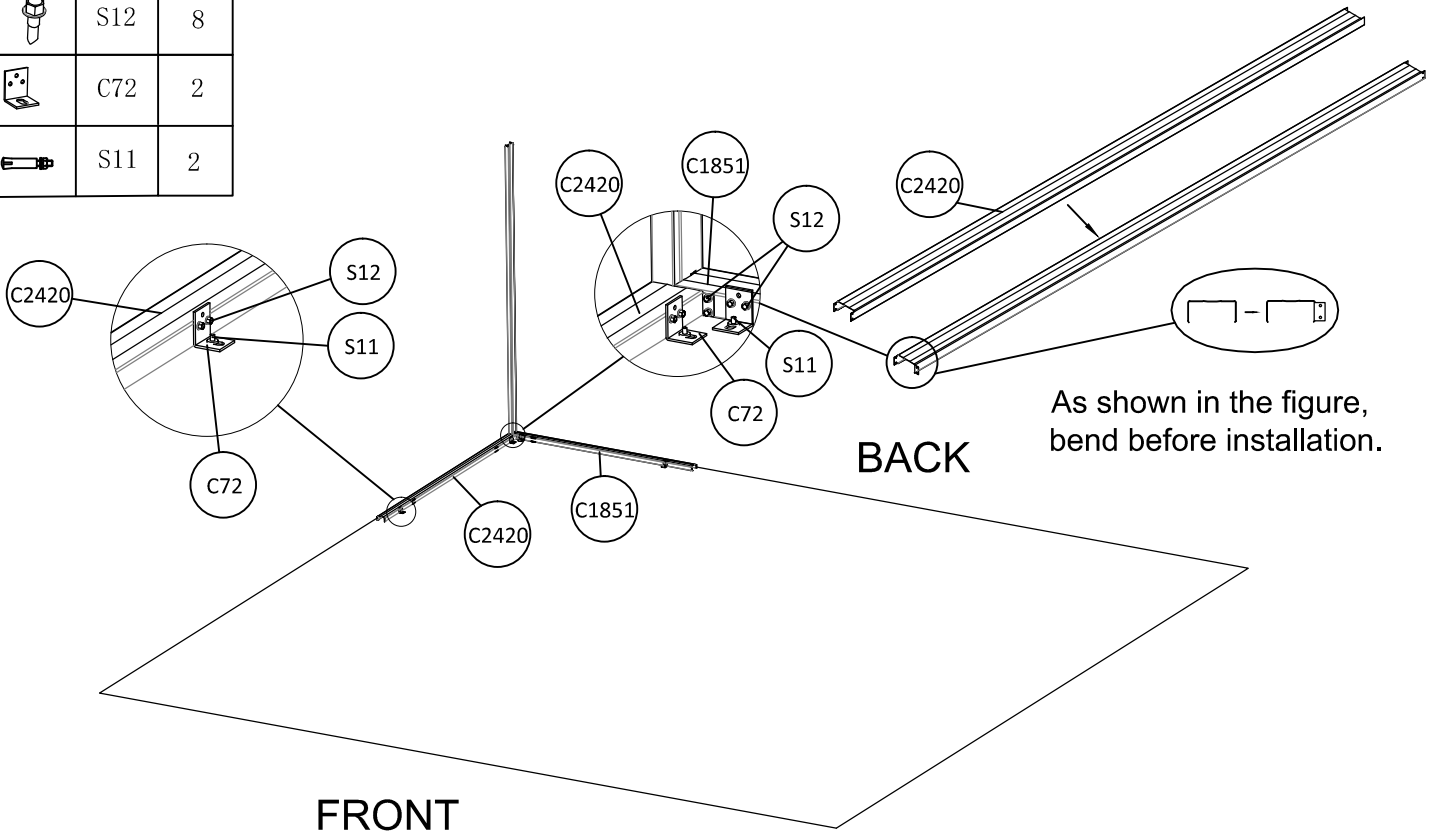







	C2420	1
	S12	8
	C72	2
	S11	2

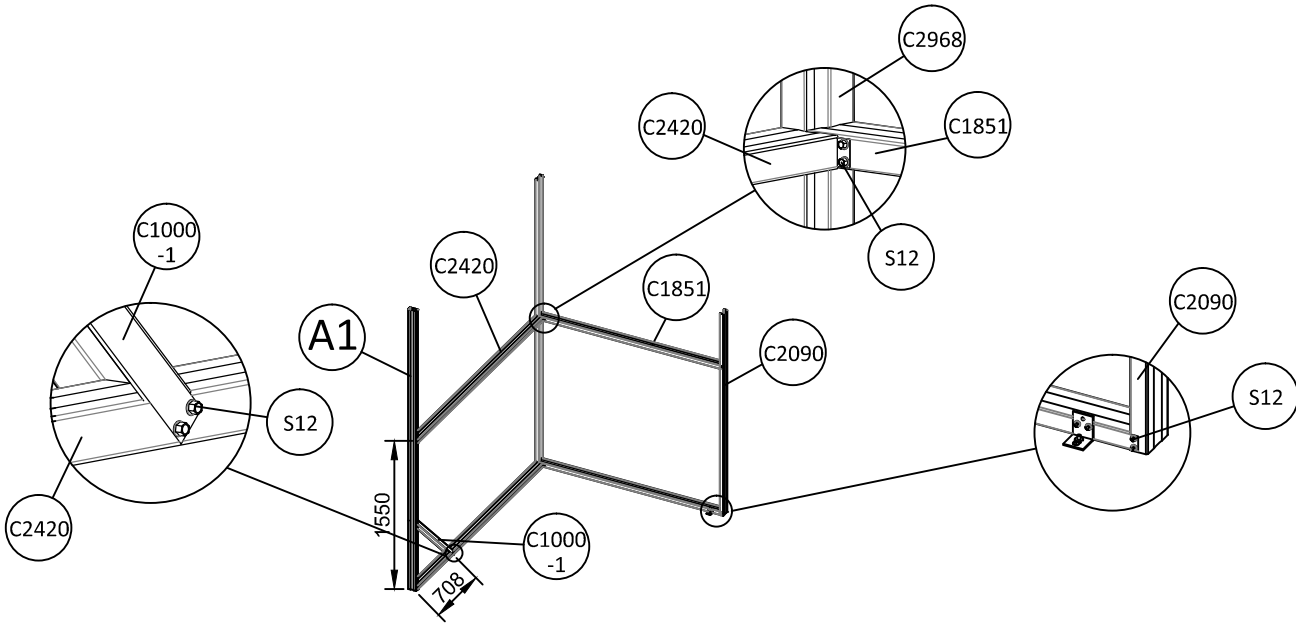

INSTALLATION FRAMEWORK







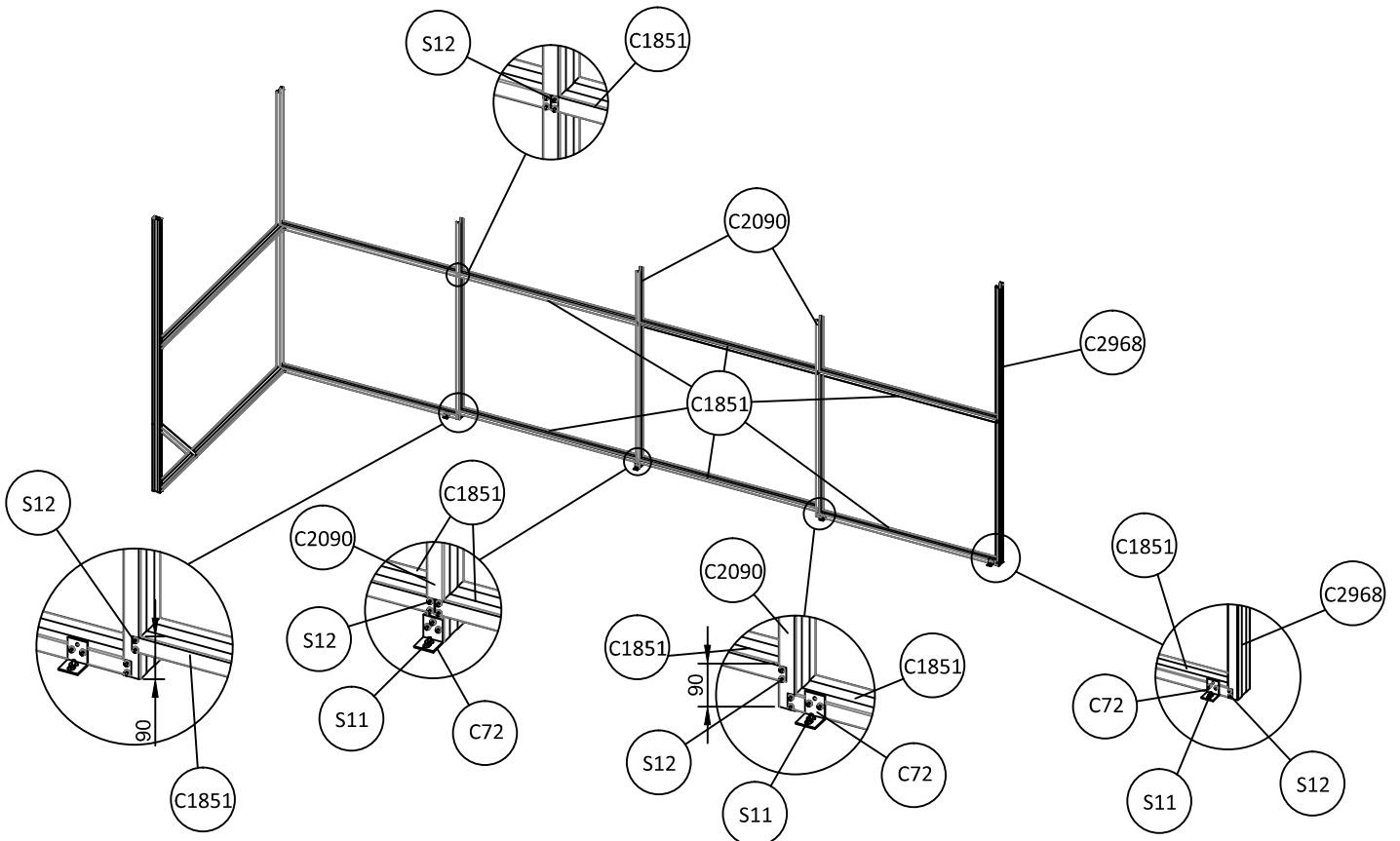





	C2420	1		C1851	1		C2090	1		C1000 -1	1		S12	32
---	-------	---	---	-------	---	---	-------	---	---	-------------	---	---	-----	----



	C1851	6		C2090	2		C2968	1		S12	56
	C72	4		S11	4						



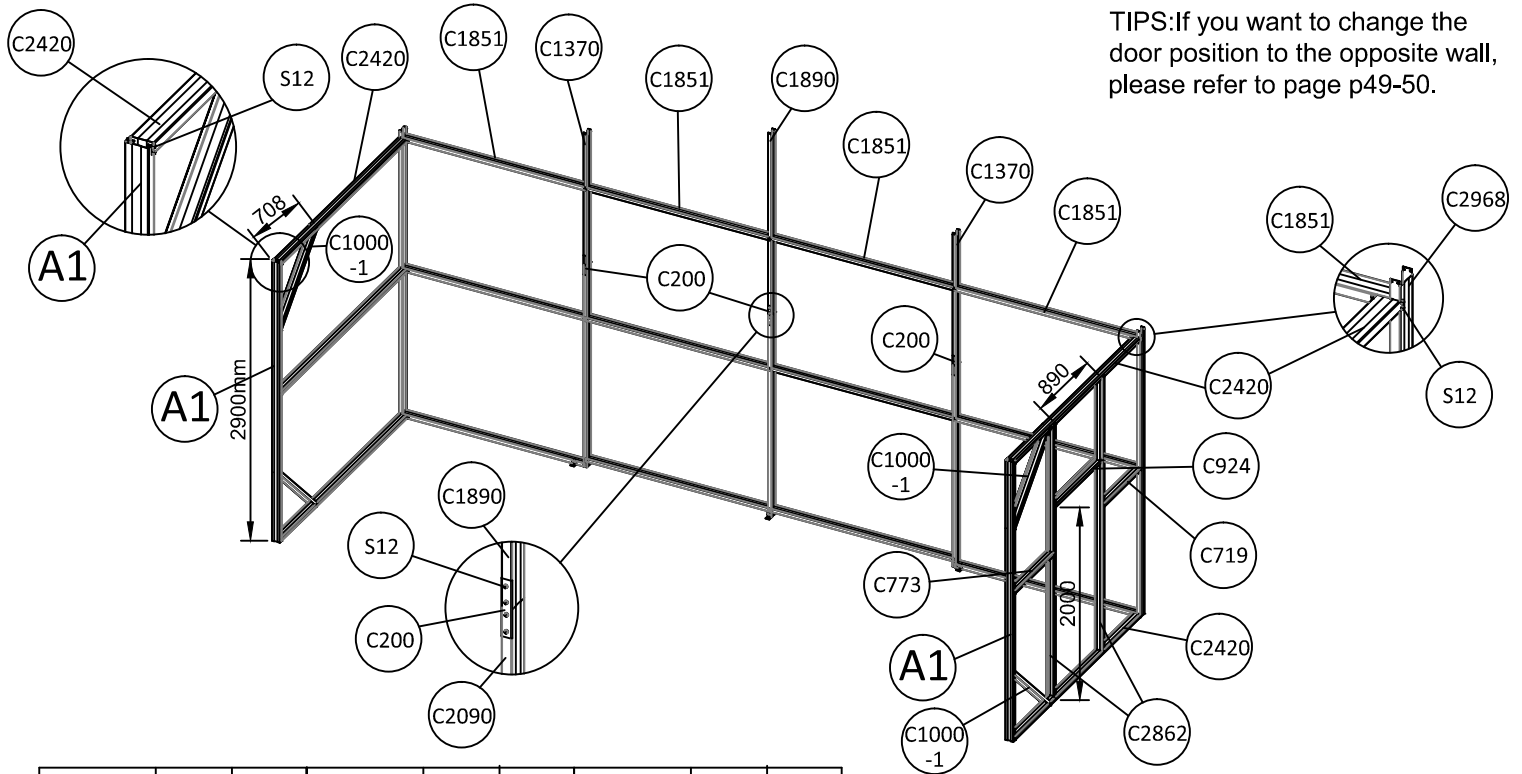

INSTALLATION FRAMEWORK

	C2420	3		C1851	4		C1370	2		C1890	1		C2862	2
	C1000-1	3		C719	1		C773	1		C924	1		C200	3
	S11	2		C72	2		S12	152						



TIPS: If you want to change the door position to the opposite wall, please refer to page p49-50.

	C1000-2	2		S12	16		C20	2						
--	---------	---	---	-----	----	---	-----	---	--	--	--	--	--	--

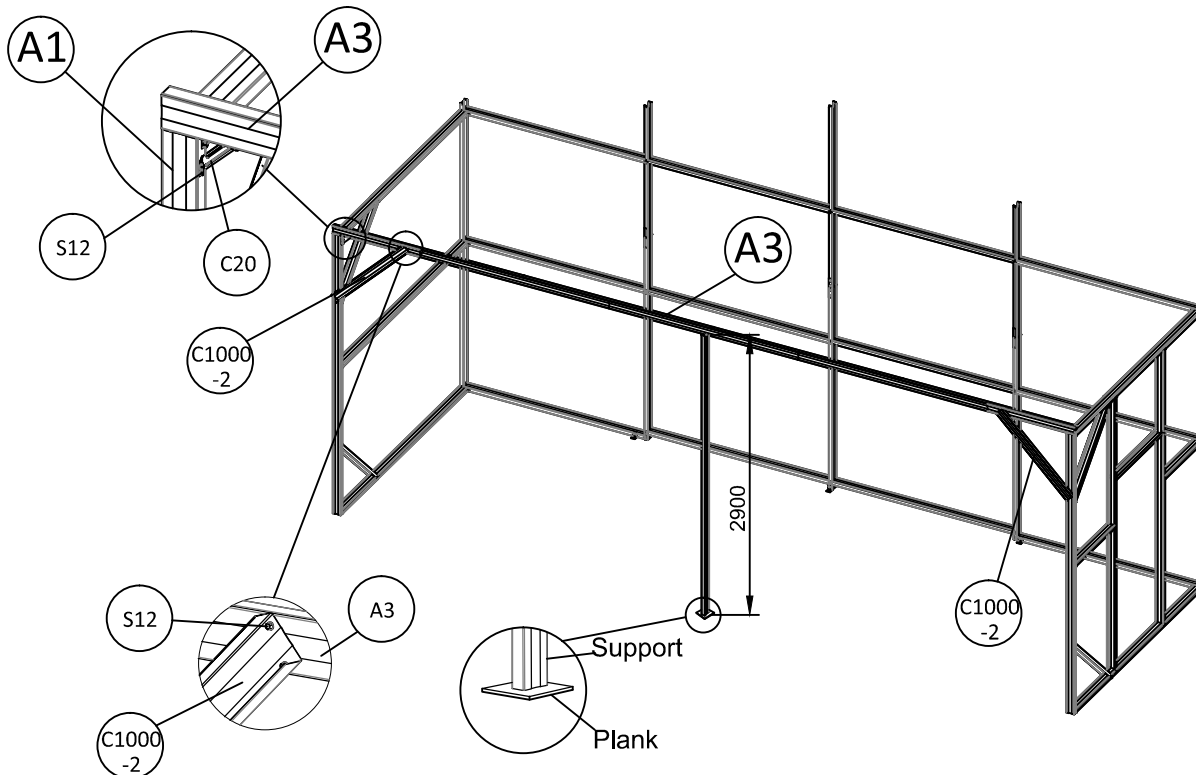

As shown in the figure, when installing A3, support it with an object with a length of 2900mm to prevent it from falling and deformation other parts can be used temporarily. If the ground is not hardened please put a board under the support to make it level with foundation.

INSTALLATION FRAMEWORK

	C73	4		S12	40
---	-----	---	---	-----	----

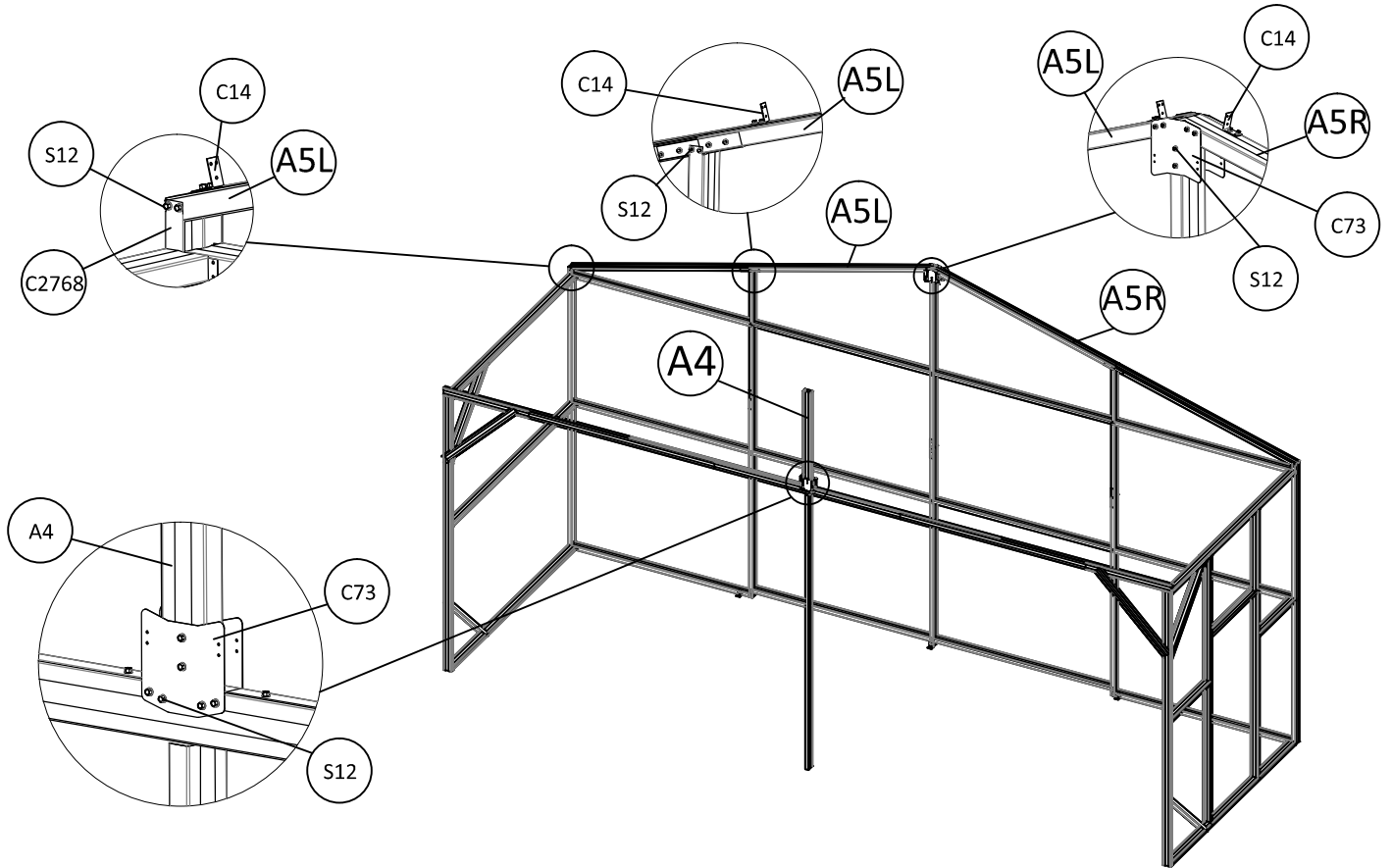

	S12	4
---	-----	---

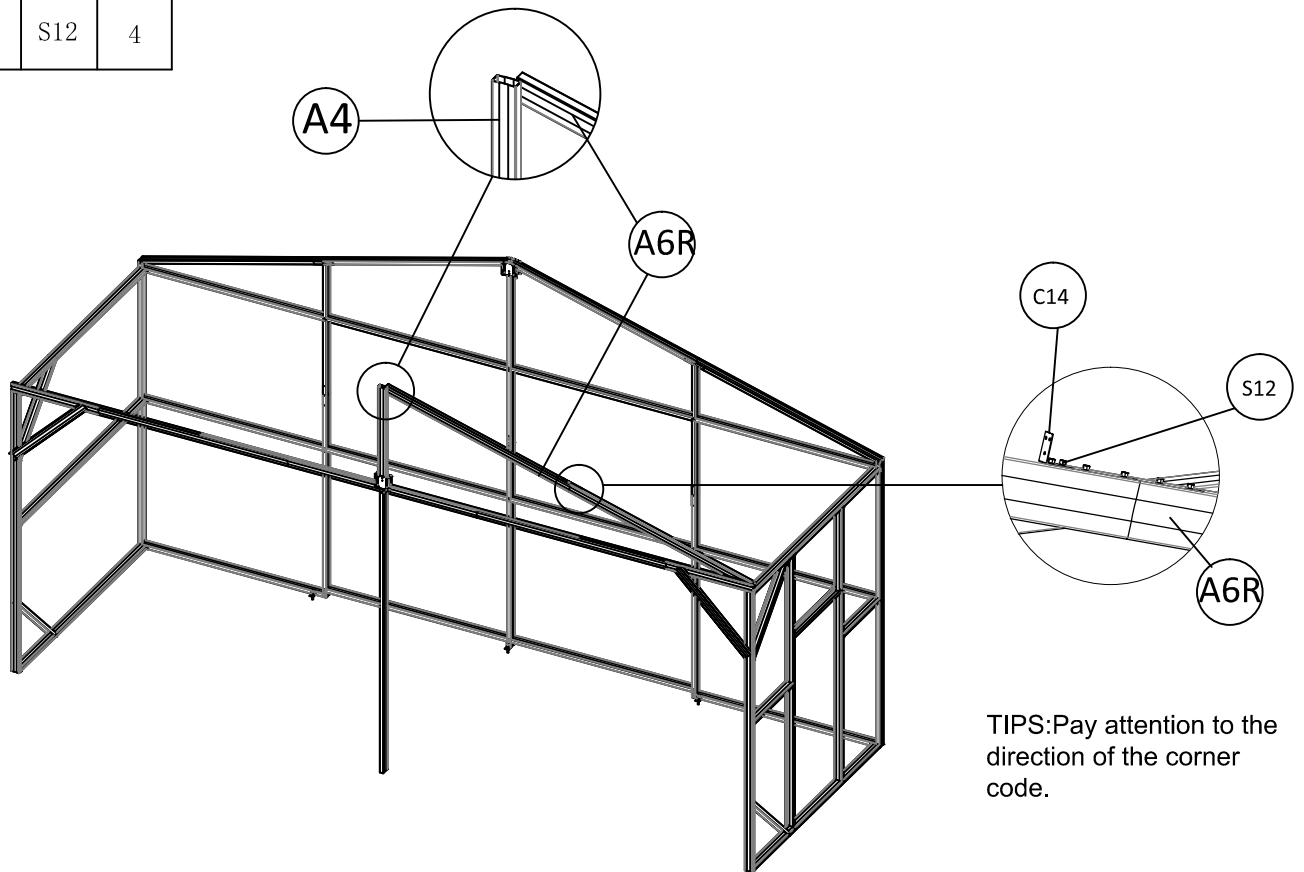



TIPS: Pay attention to the direction of the corner code.

INSTALLATION FRAMEWORK

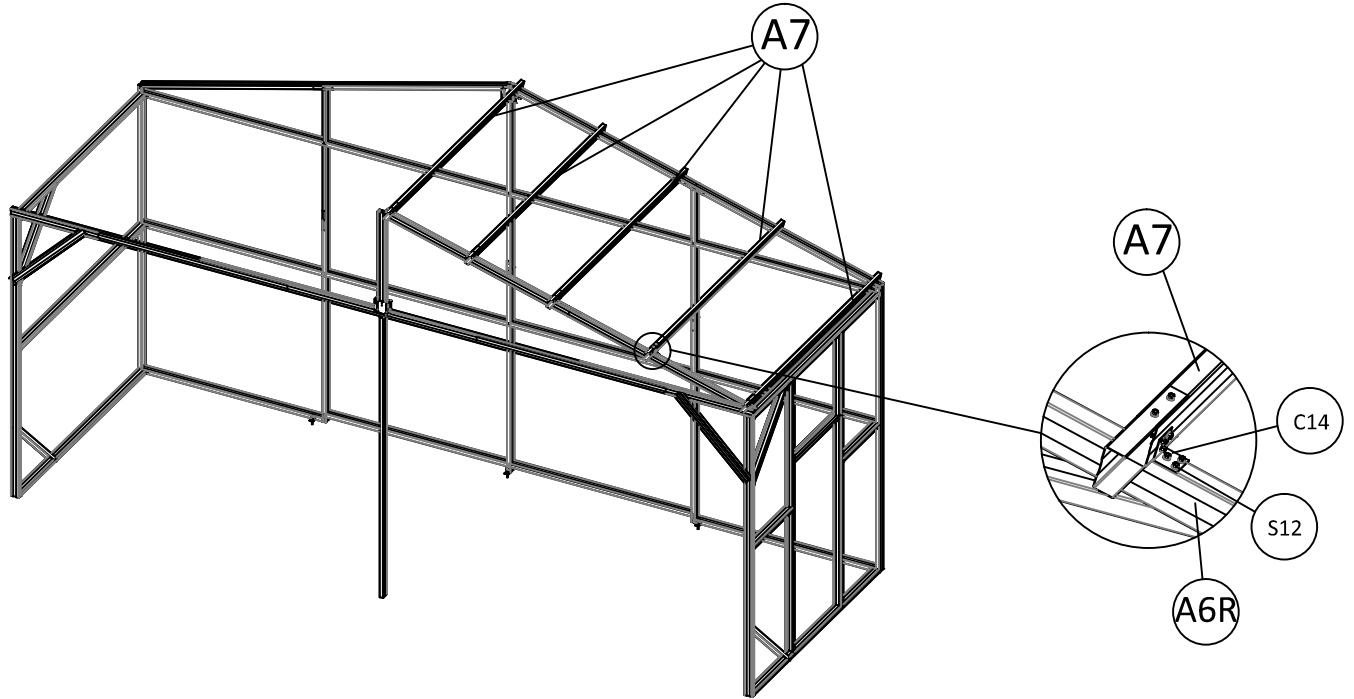
	S12	30
---	-----	----



	S12	42		L800	2
---	-----	----	---	------	---

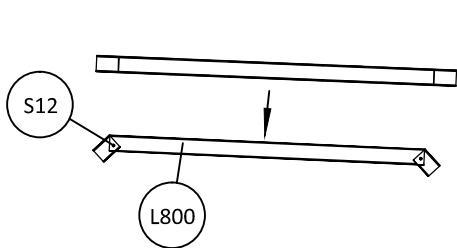

Note: please bend the L800 to a proper angle at the notch before installation.

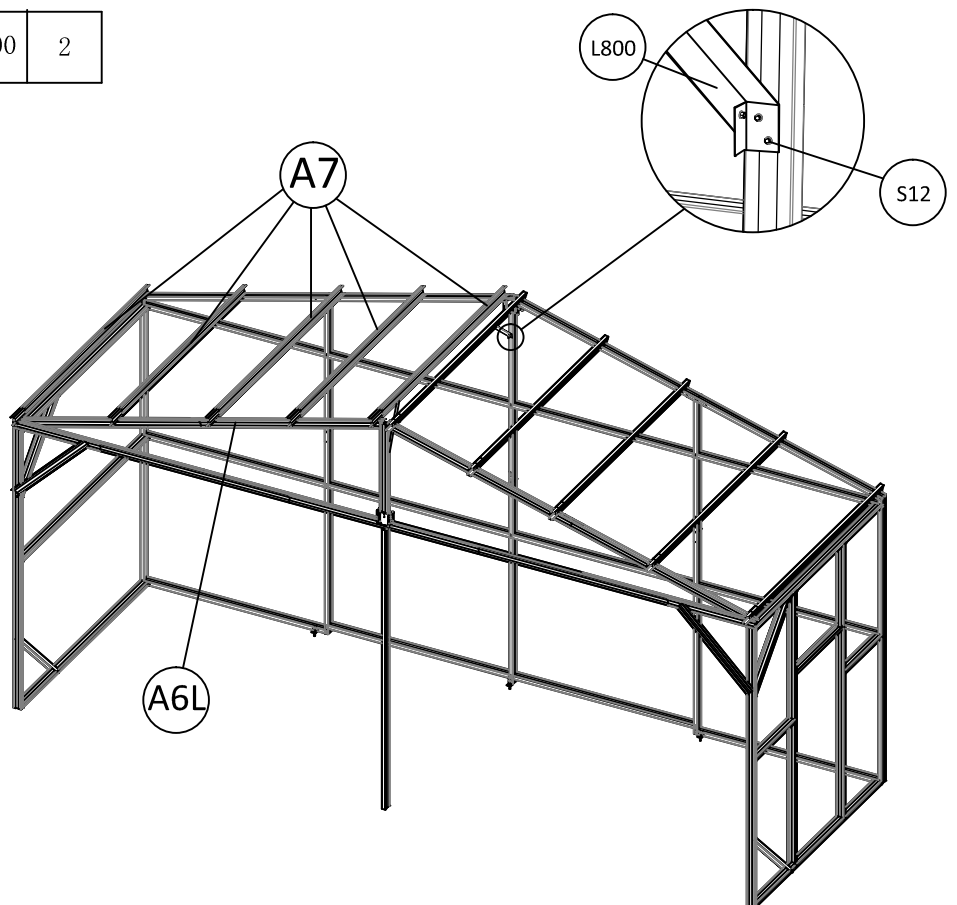

INSTALLATION FRAMEWORK



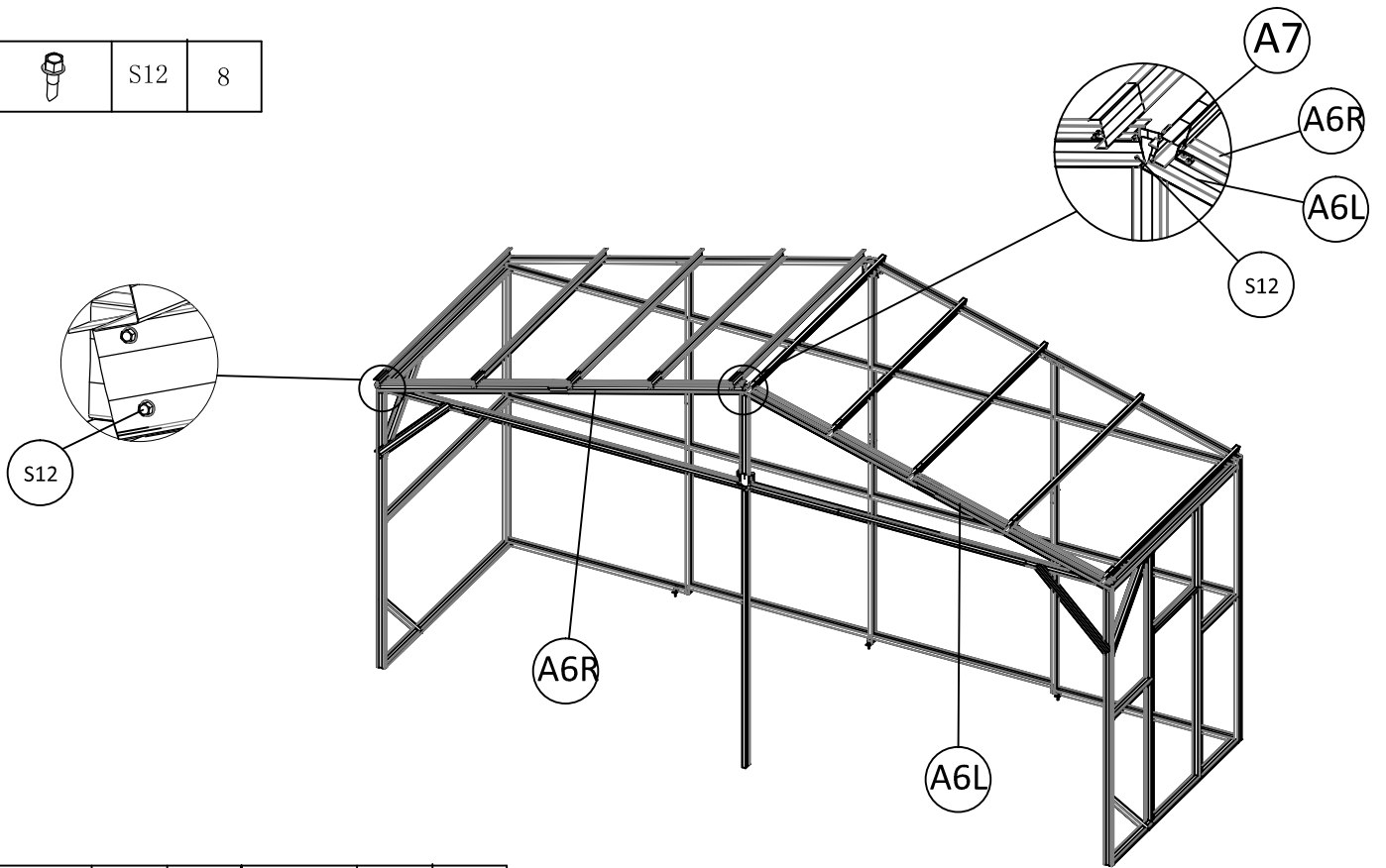

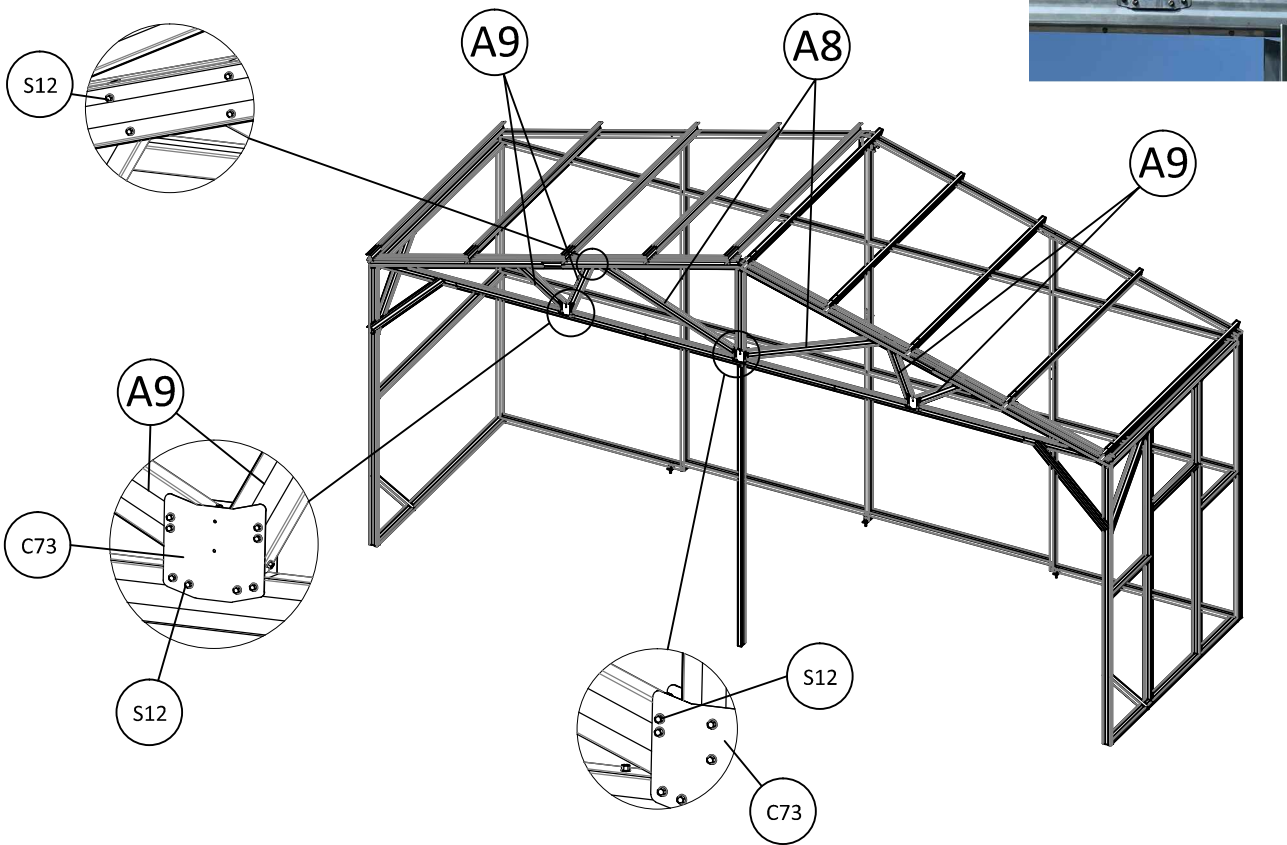

	S12	8
---	-----	---



	C73	4		S12	64
---	-----	---	---	-----	----



INSTALLATION FRAMEWORK

	C2484-1	6		C1000-2	2		S12	76		S11	2		C72	2
	C20	2												

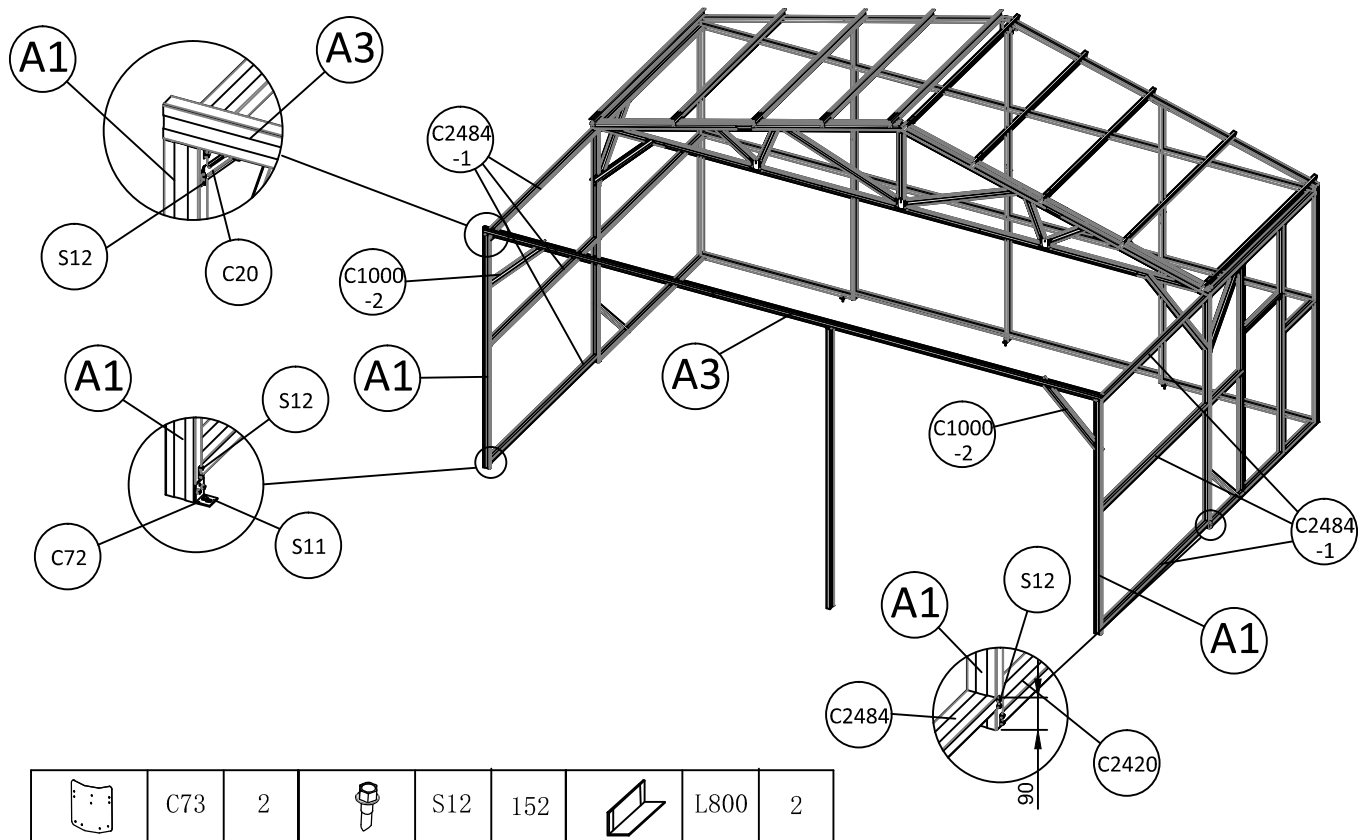

STEP ONE

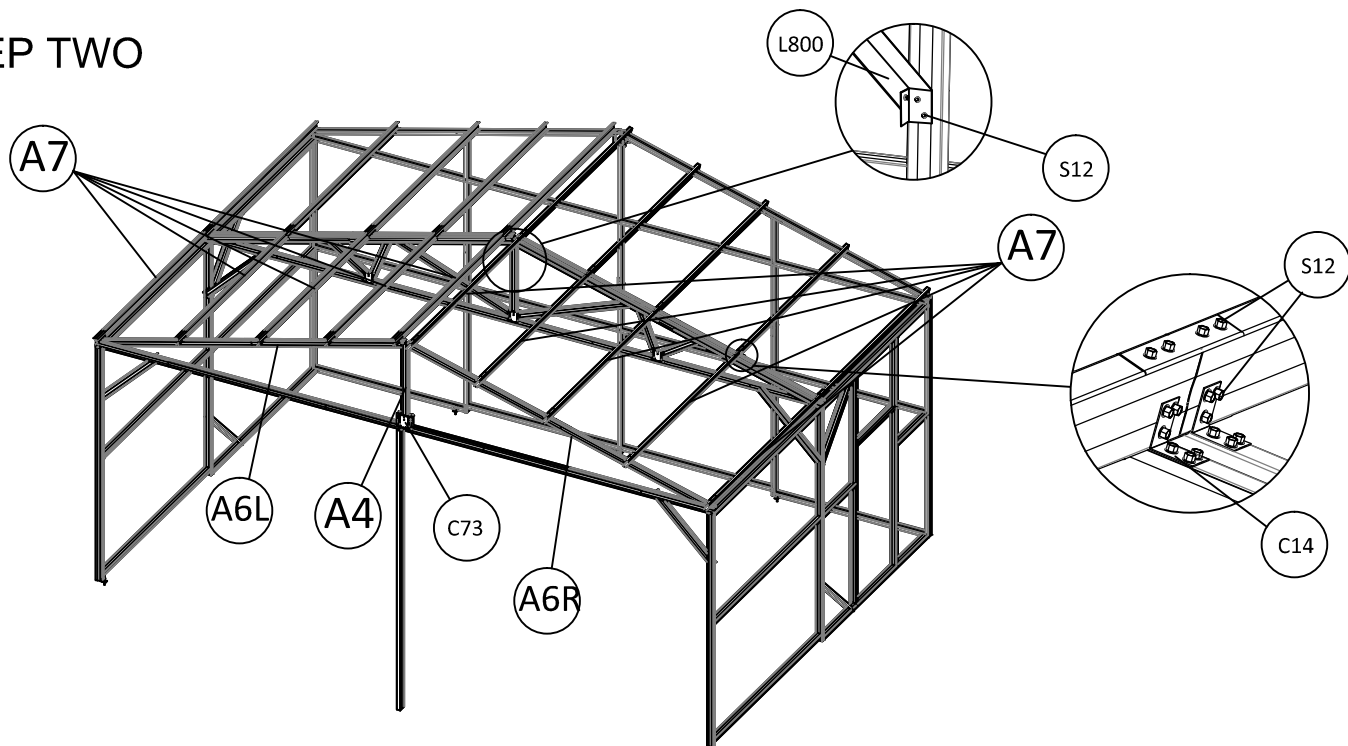

STEP TWO



INSTALLATION FRAMEWORK

	C73	4		S12	72
---	-----	---	---	-----	----

STEP THREE

MS2525

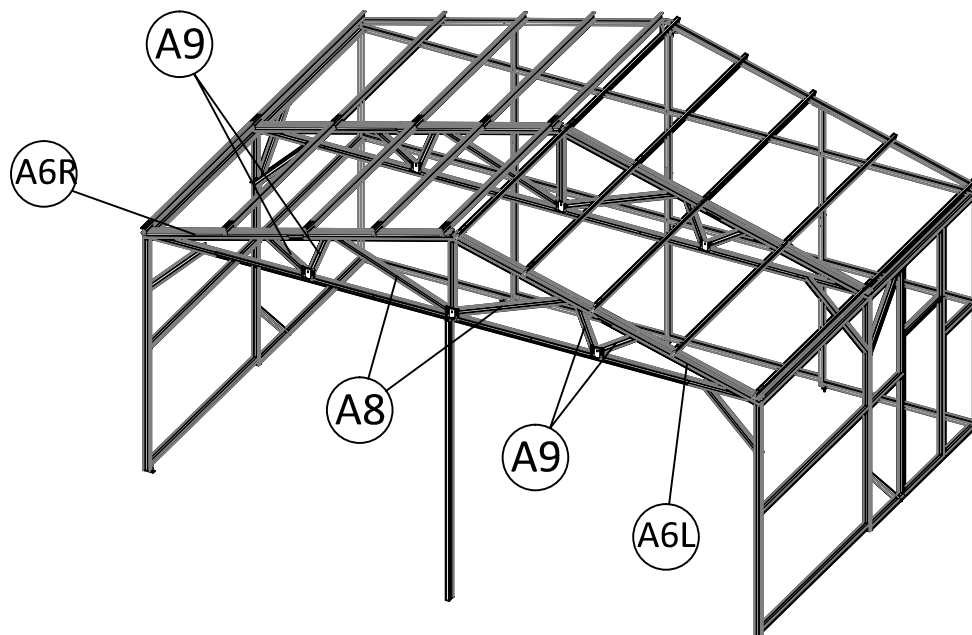

Repeat STEP ONE to STEP THREE once to complete MS2533.

MS2533

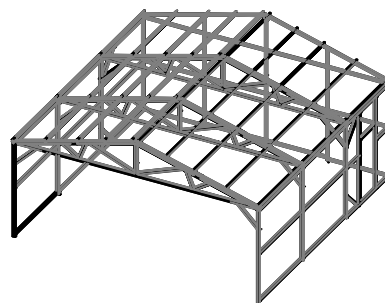





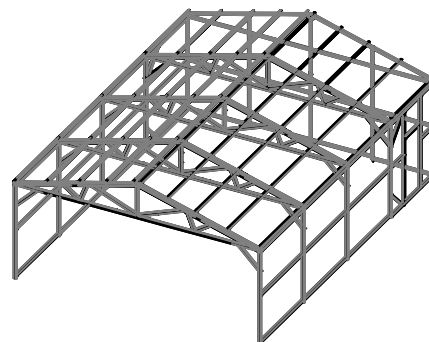





Repeat STEP ONE to STEP THREE twice to complete MS2541.

MS2541





INSTALLATION FRAMEWORK

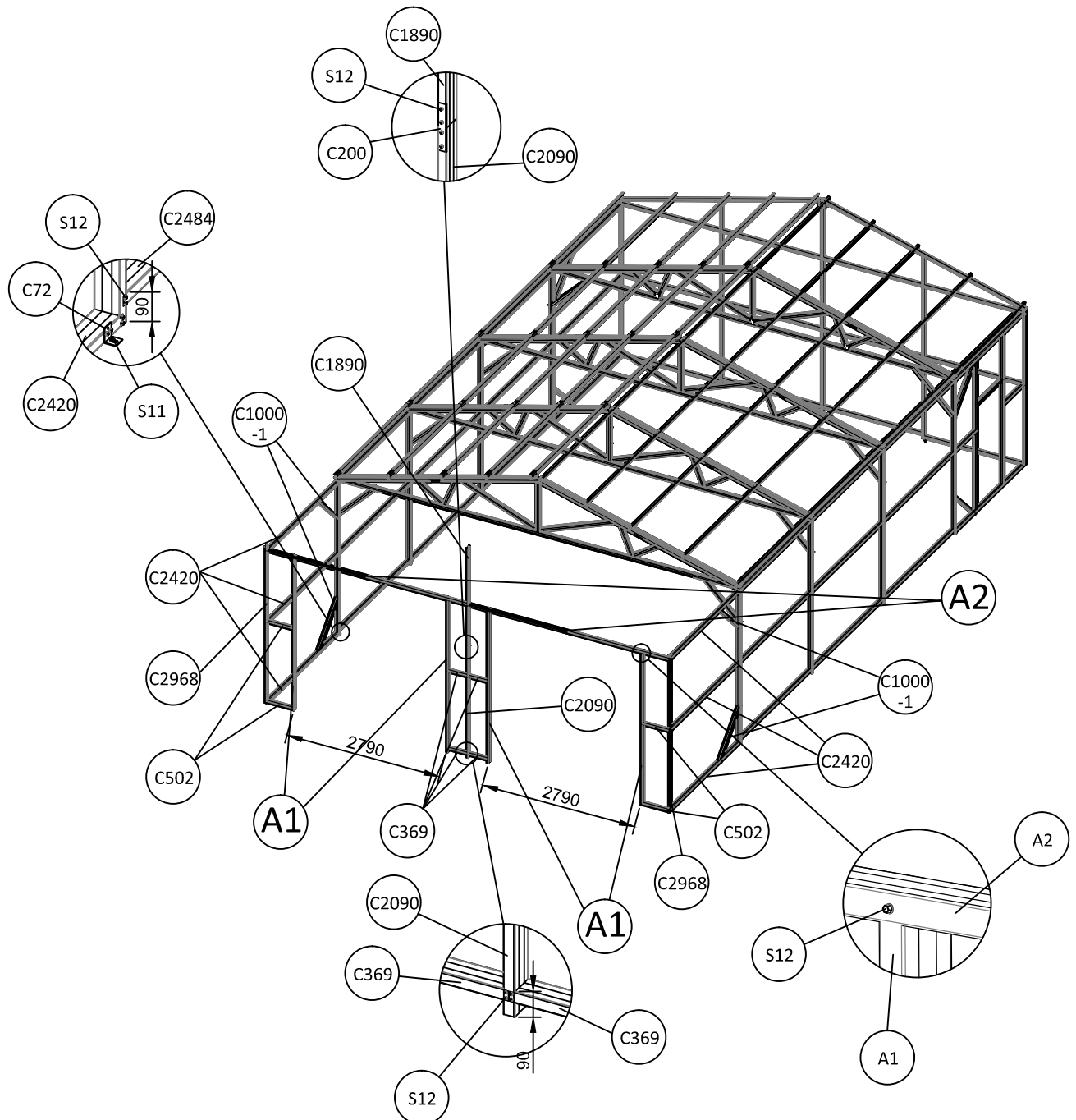

	C2420	6		C1890	1		C502	4		C369	4		C1000-1	4
	C2090	1		C2968	2		C200	1		S11	9		C72	9
	S12	194												

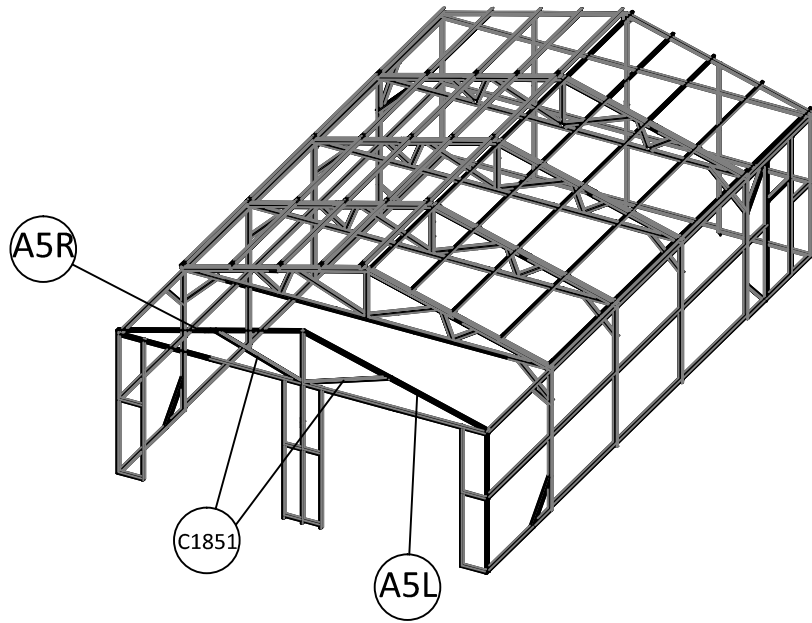

INSTALLATION FRAMEWORK

	C1851	2		S12	16
---	-------	---	---	-----	----



	C2484 -2	10		S12	72		L800	2
---	-------------	----	---	-----	----	---	------	---

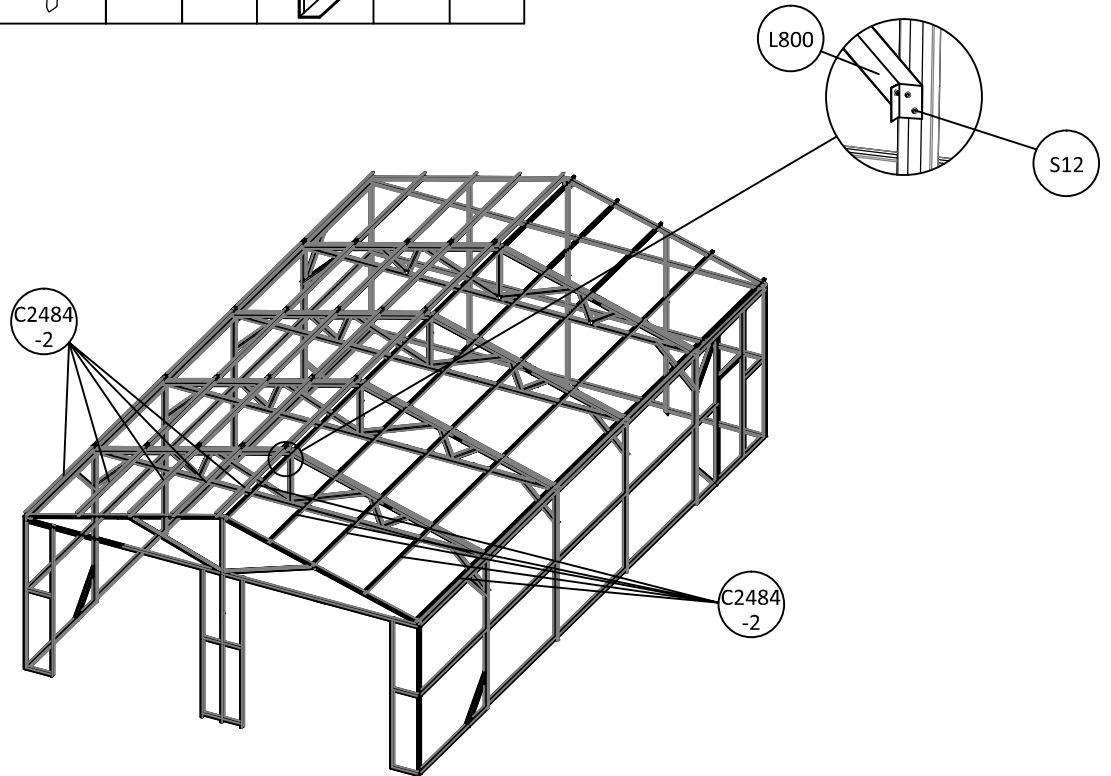



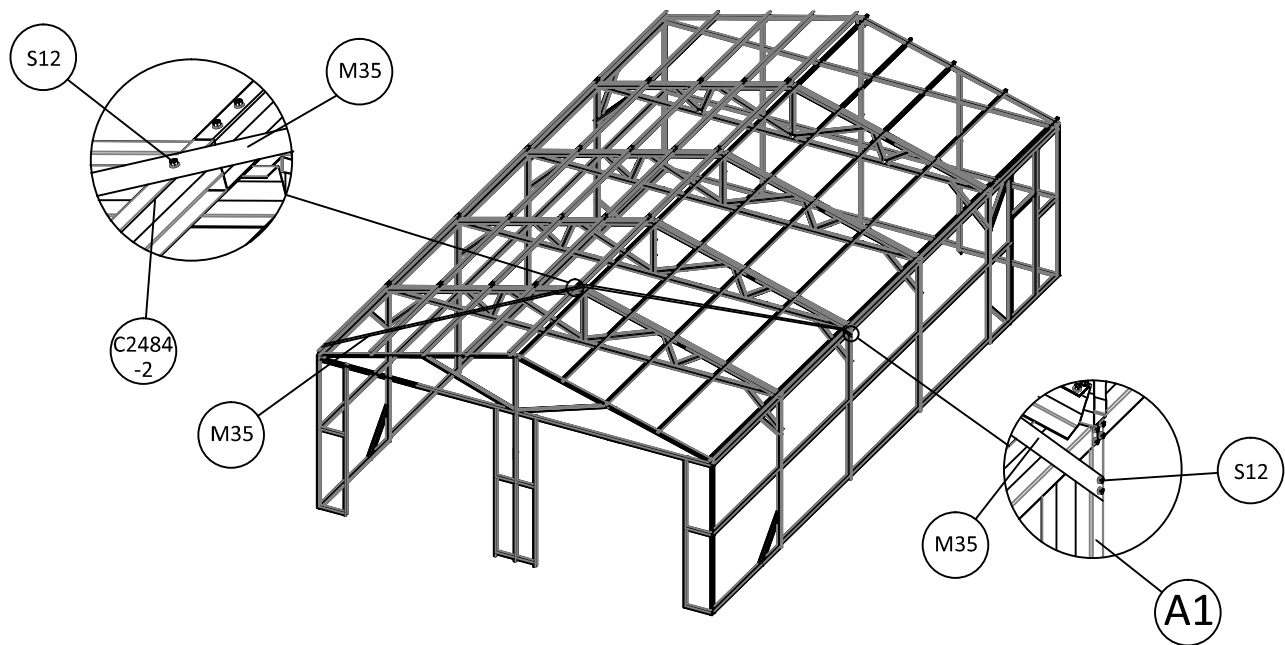

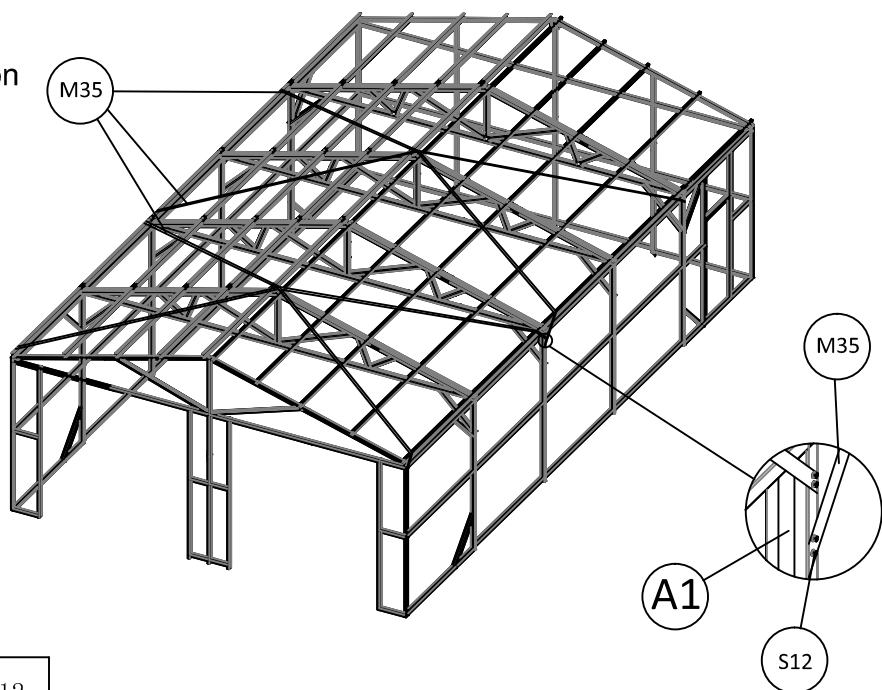

INSTALLATION FRAMEWORK





As shown in the figure, M35 diagonal is used to fix every two spans of the row to increase the overall strength. During installation, fix one end of M35 on the column, tighten it from the top of the roof to the other side, and fix it on the column on the other side. After fixing, please cut the excess part to an appropriate length. (please align the frame before installation)





MS2525		M35	2		S12	12
MS2533		M35	4		S12	24
MS2541		M35	4		S12	24

INSTALLATION WALL TILE

	P1550	9		S12	36
---	-------	---	---	-----	----

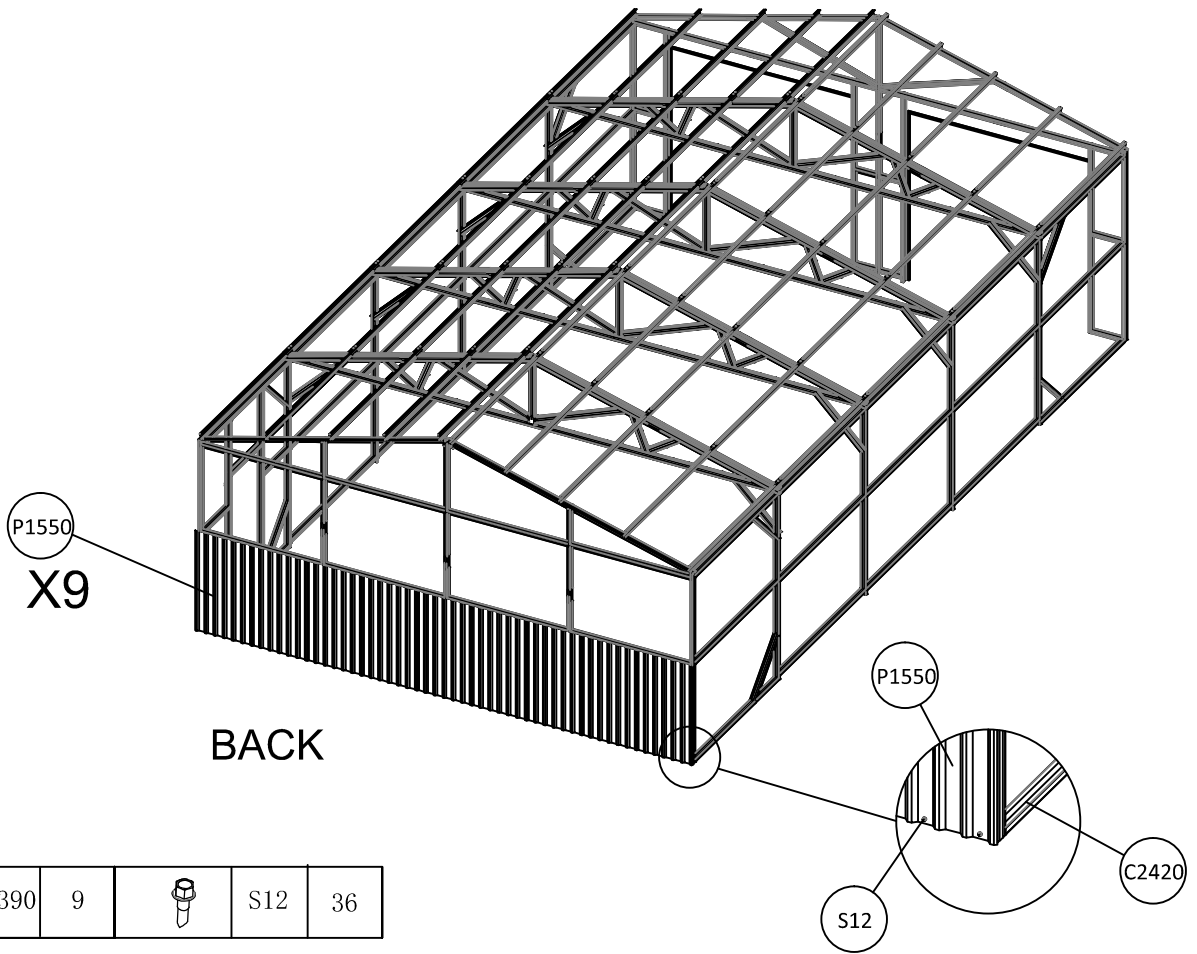





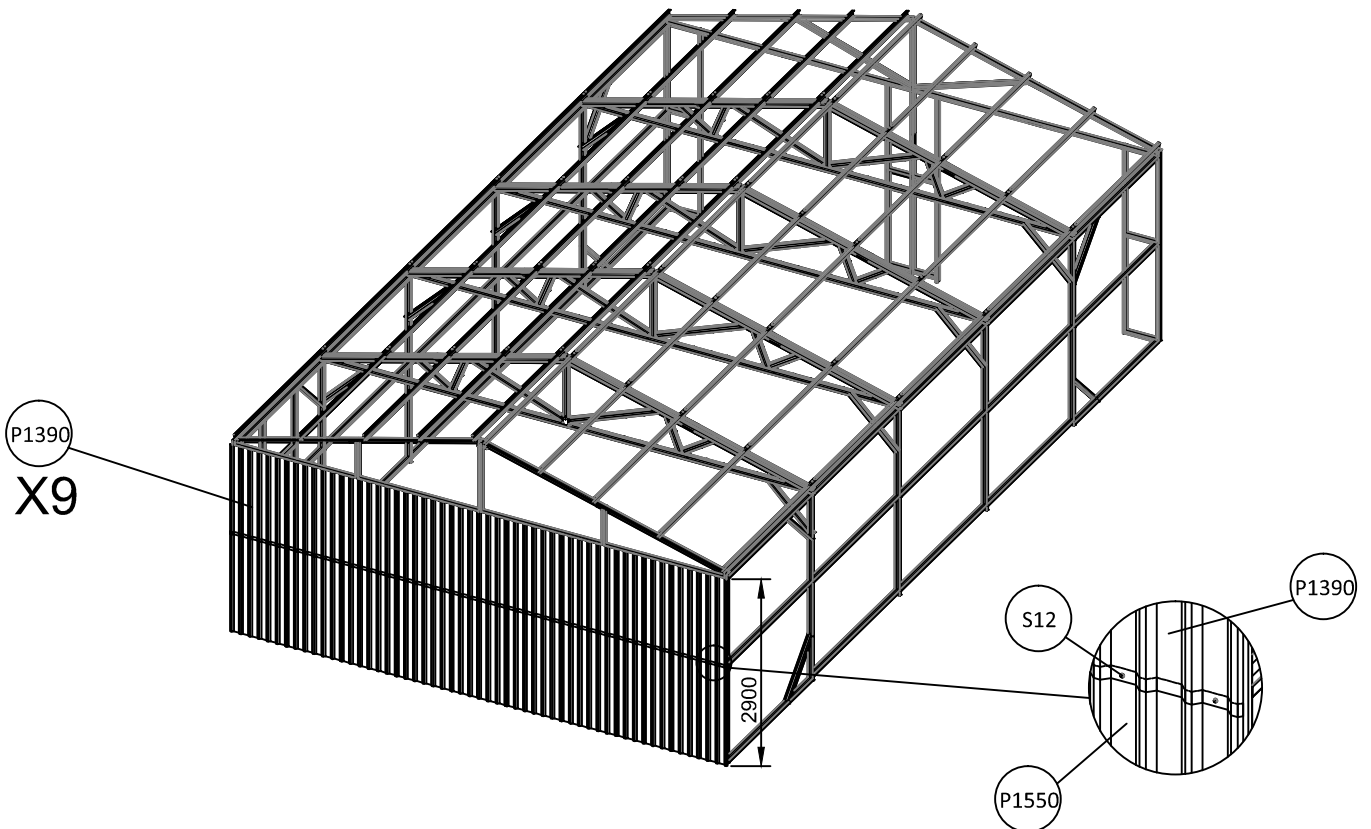



FRONT





	P1390	9		S12	36
---	-------	---	---	-----	----

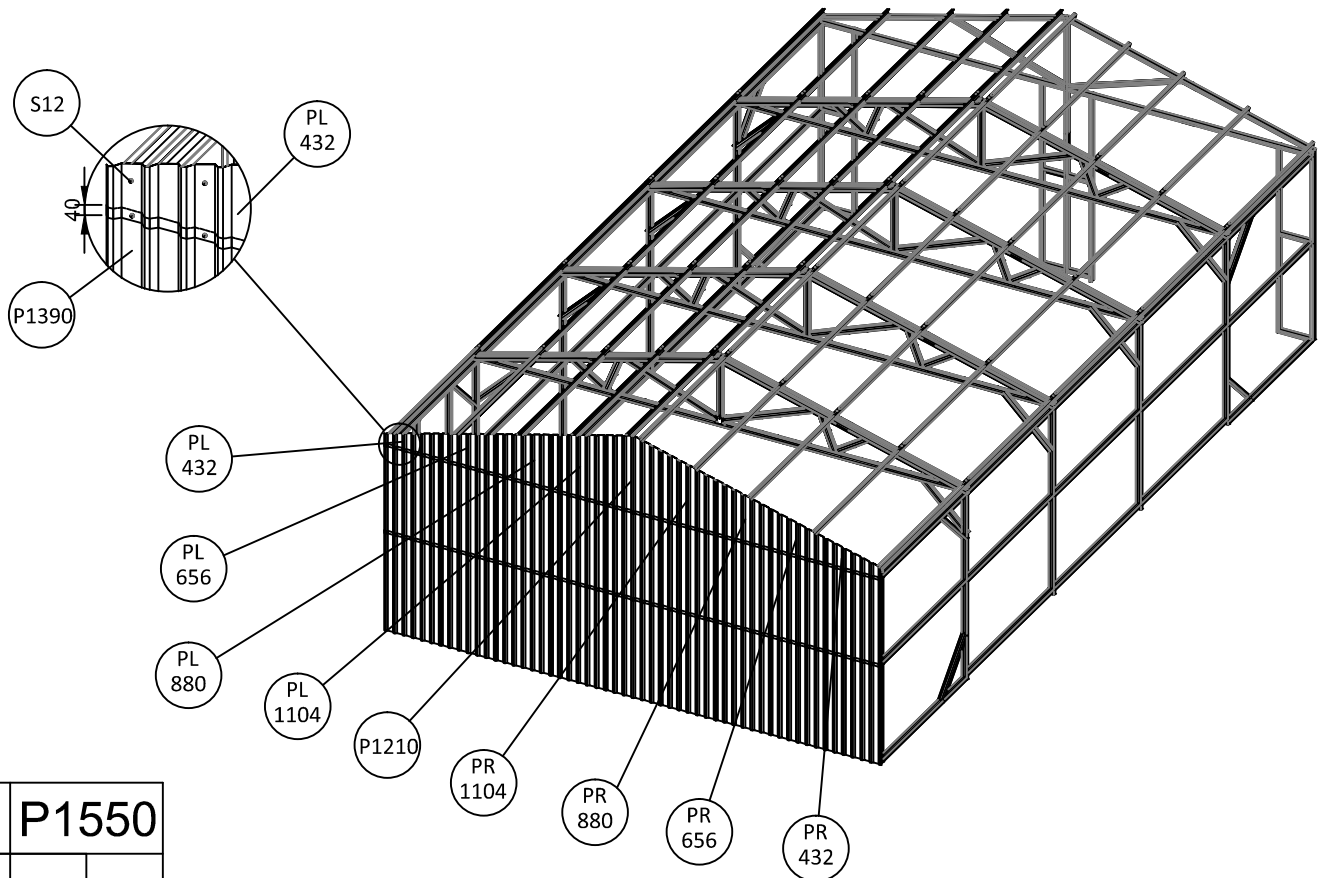

INSTALLATION WALL TILE

	S12	72		PL432	1		PL656	1		PL880	1		PL 1104	1
	P1210	1		PR432	1		PR656	1		PR880	1		PR 1104	1



	P1550	
MODEL	n	S12
MS2525	9	36
MS2533	12	48
MS2541	15	60

TIPS: Select the quantity corresponding to the table for assembly according to model.

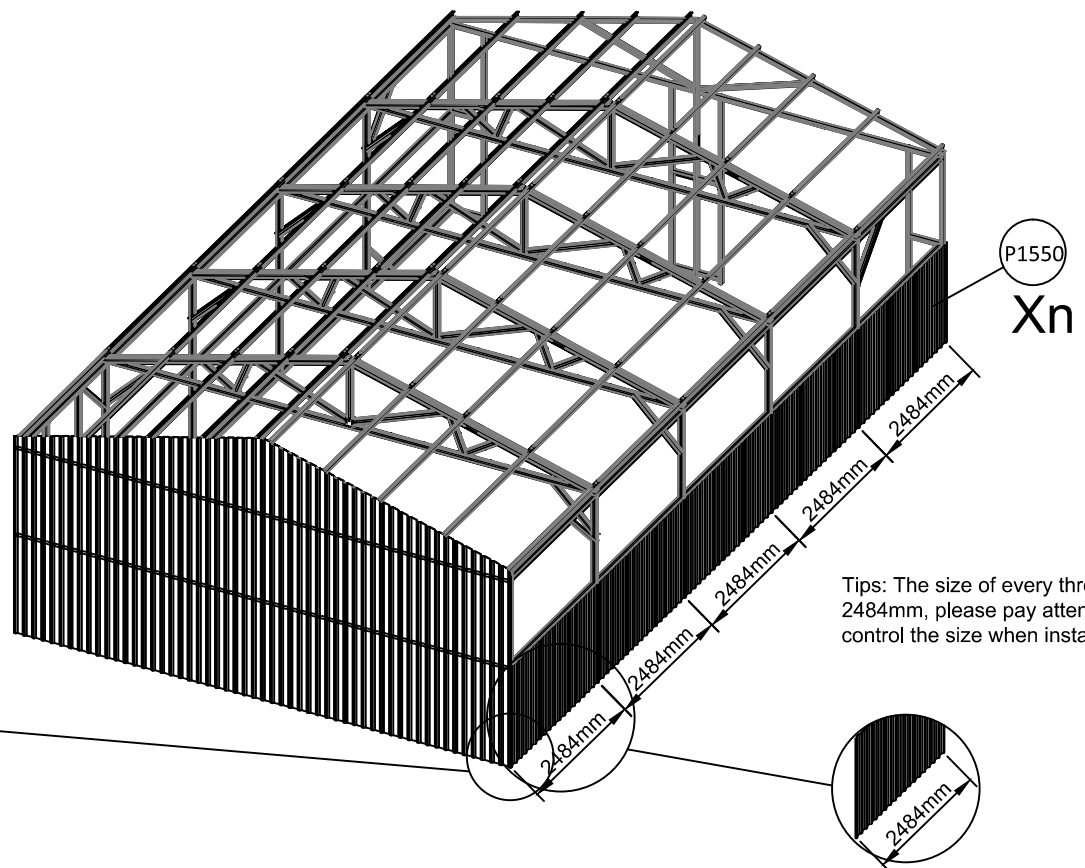

Tips: The size of every three tiles is 2484mm, please pay attention to control the size when installing.

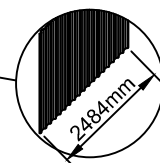
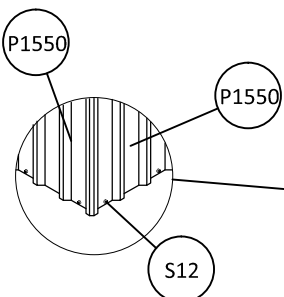



INSTALLATION WALL TILE

	P1550	
MODEL	n	S12
MS2525	8	64
MS2533	11	88
MS2541	14	112

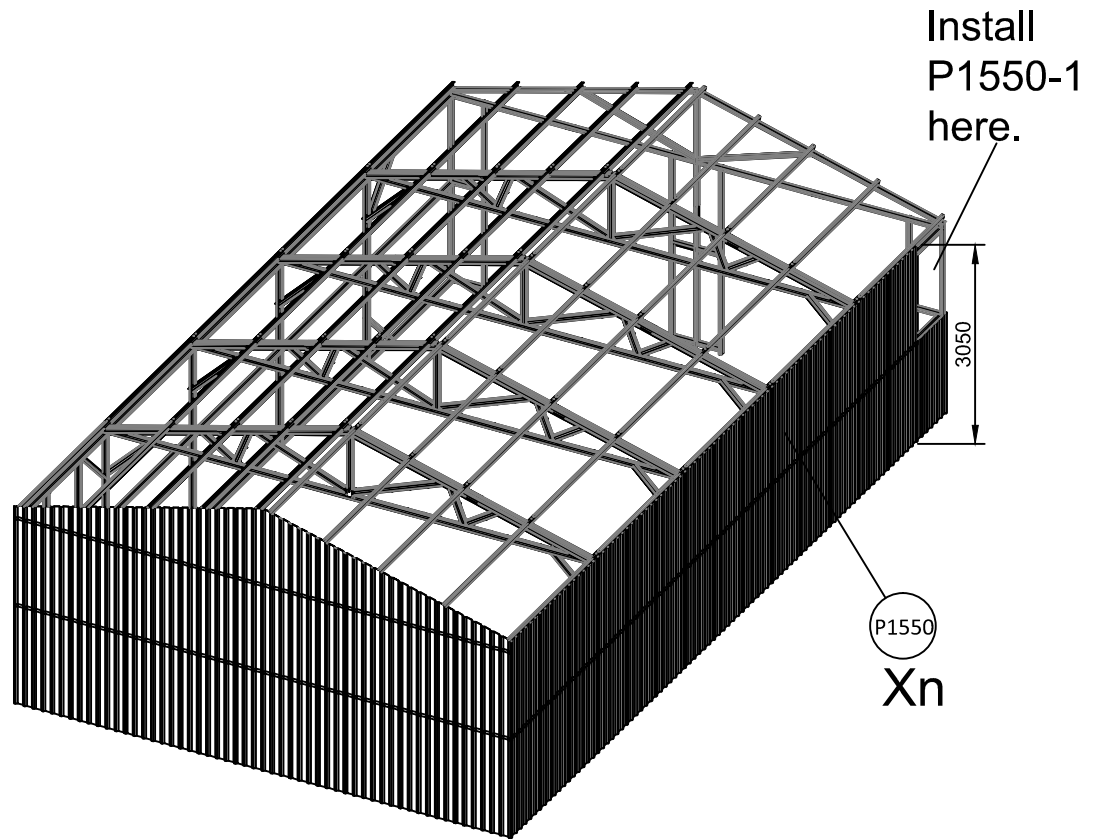

TIPS: Select the quantity corresponding to the table for assembly according to model.



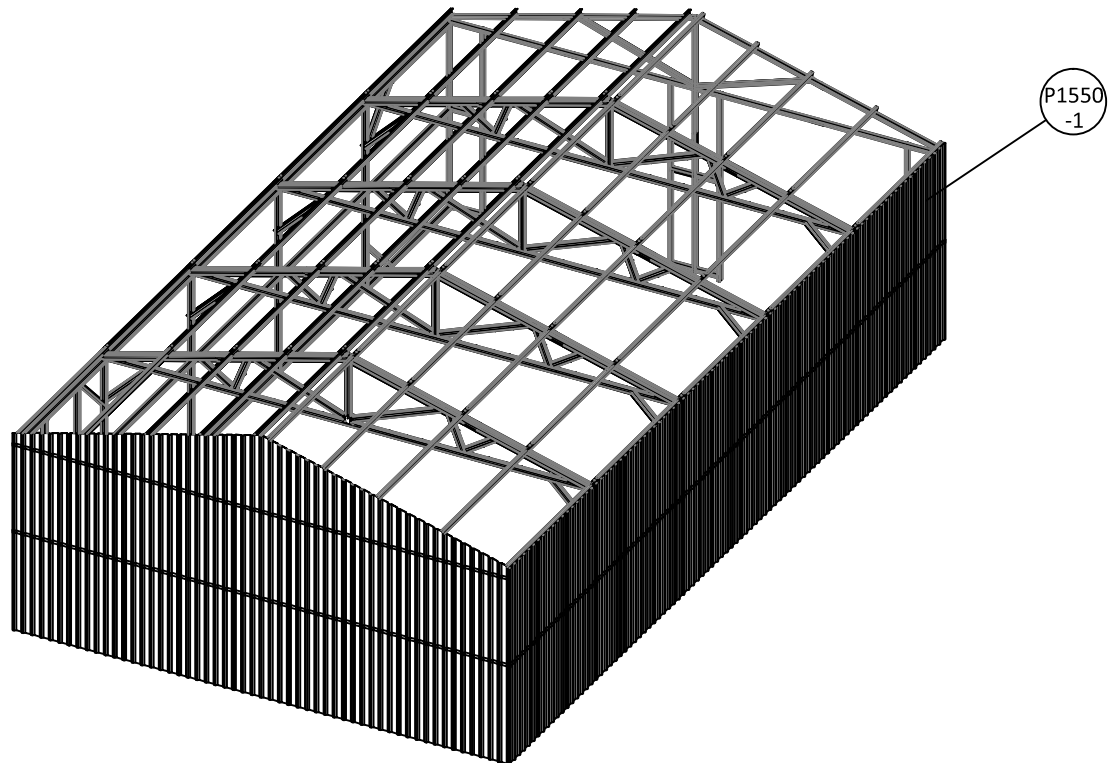



	P1550 -1	1		S12	8
---	-------------	---	---	-----	---

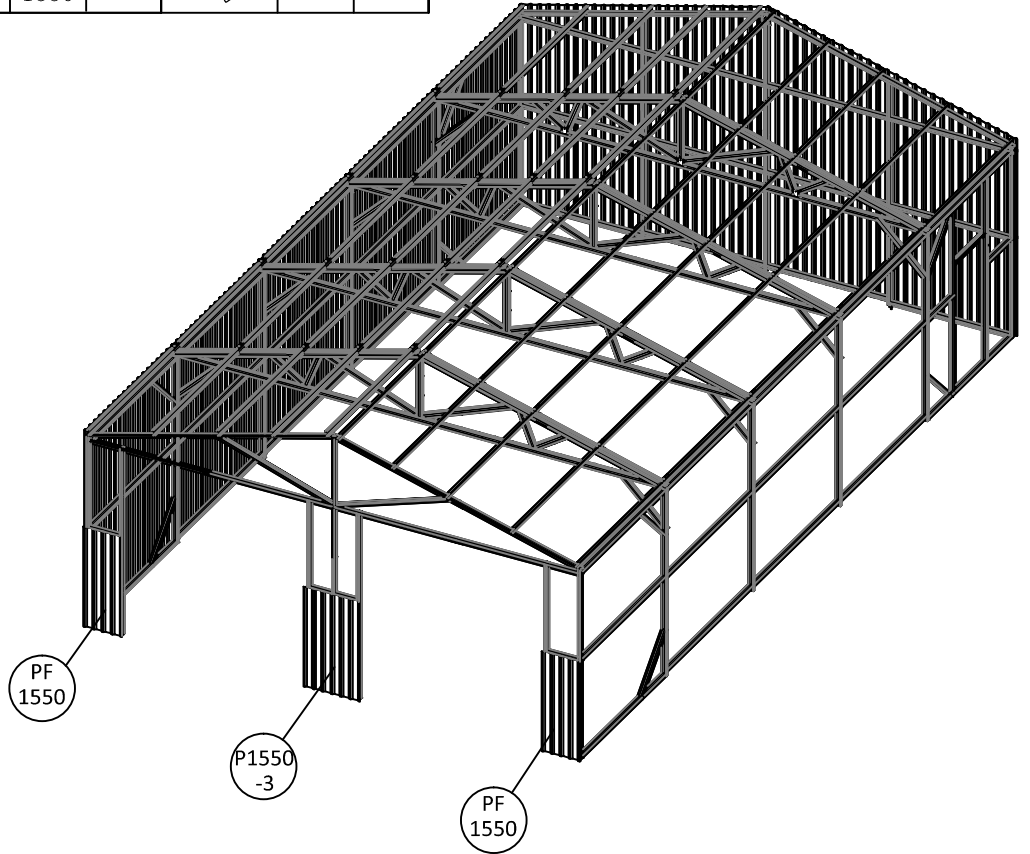

INSTALLATION WALL TILE







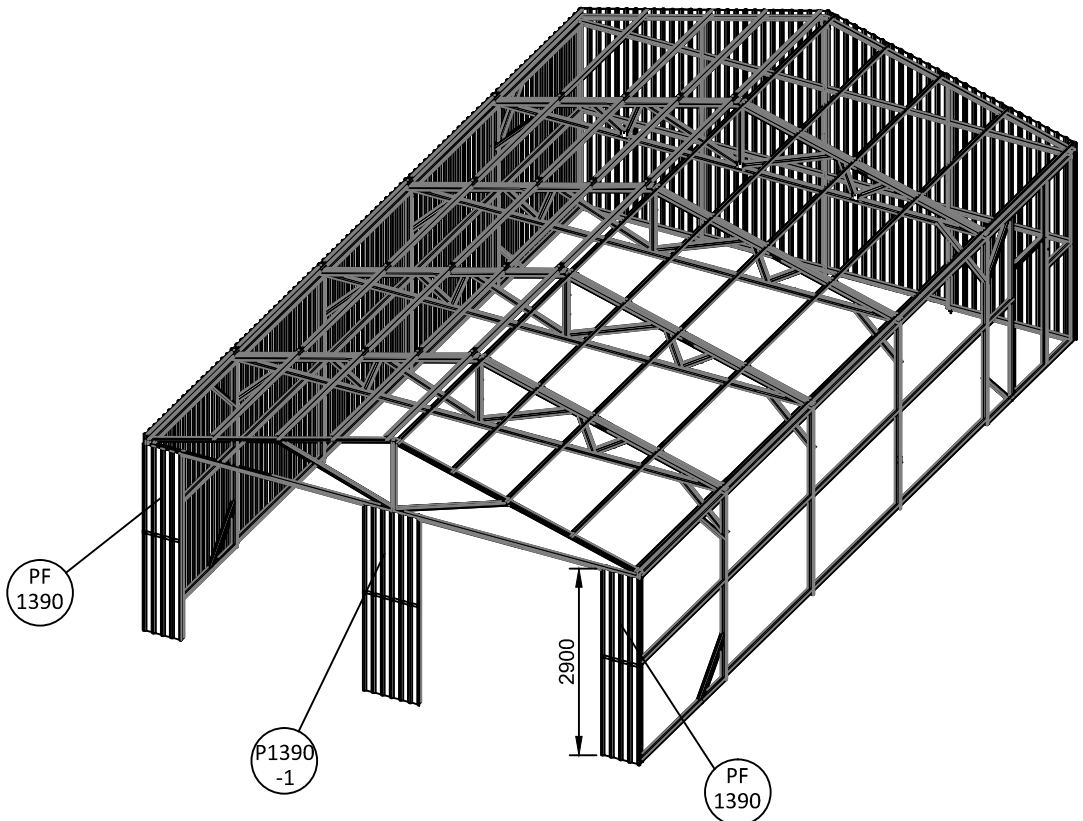



	P1550 -3	1		PF 1550	2		S12	12
---	-------------	---	---	------------	---	---	-----	----





	P1390 -1	1		PF 1390	2		S12	12
---	-------------	---	---	------------	---	---	-----	----

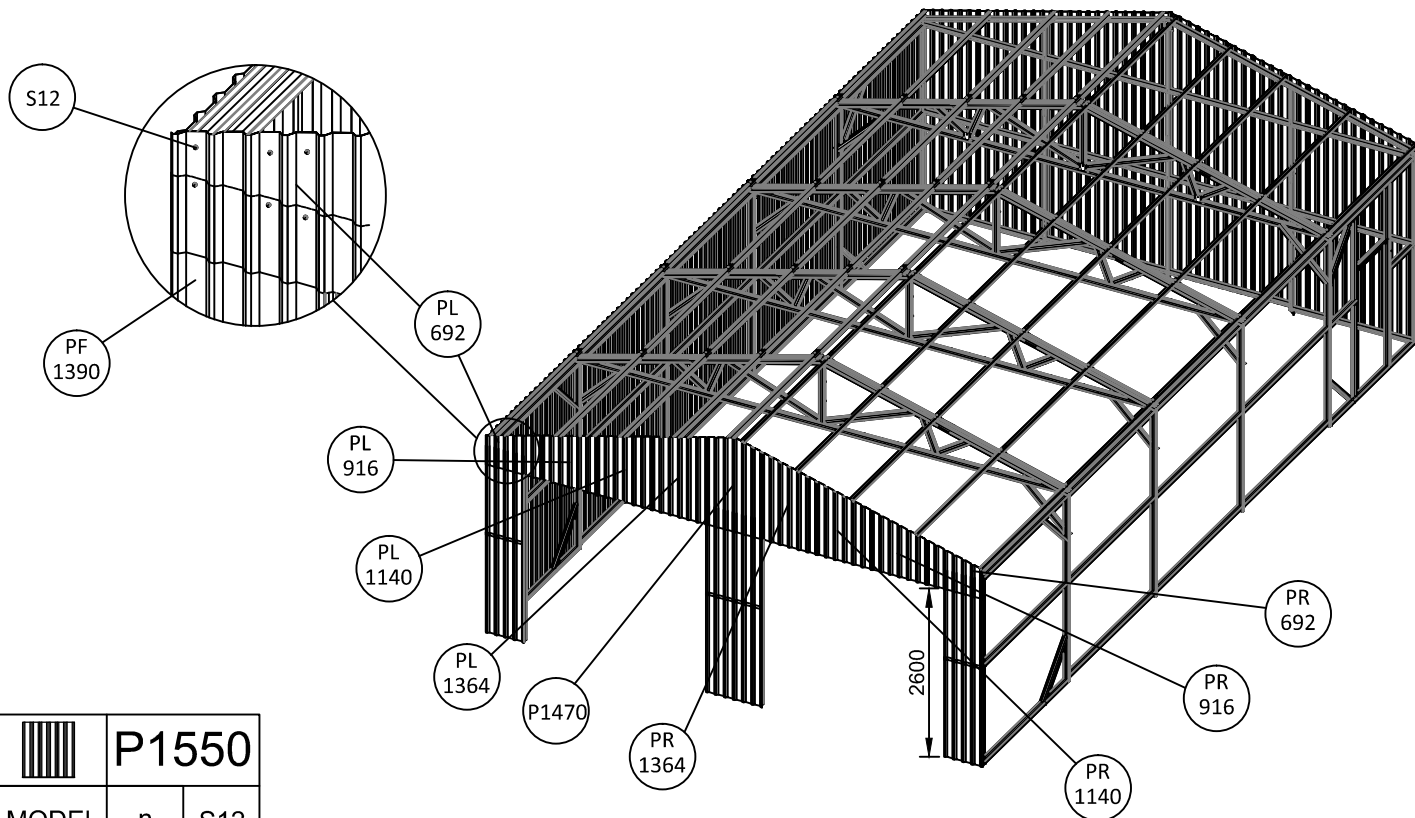

INSTALLATION WALL TILE

	S12	72		PL692	1		PL916	1		PL 1140	1		PL 1364	1
	P1470	1		PR692	1		PR916	1		PR 1140	1		PR 1364	1





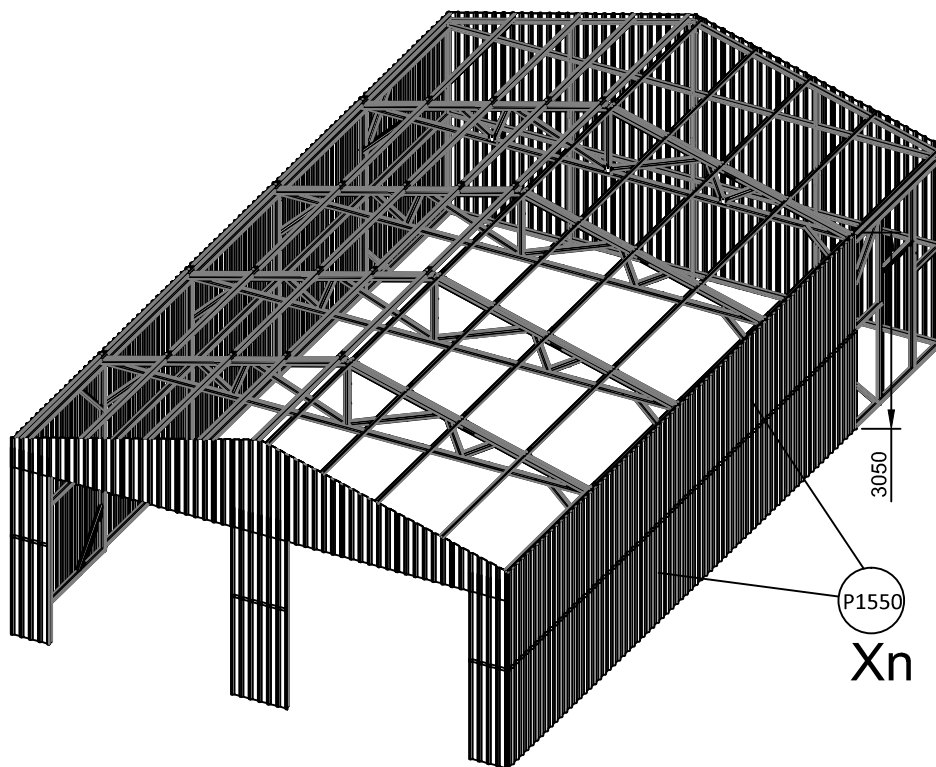

	P1550	
MODEL	n	S12
MS2525	12	144
MS2533	18	216
MS2541	24	288





TIPS: Select the quantity corresponding to the table for assembly according to model.

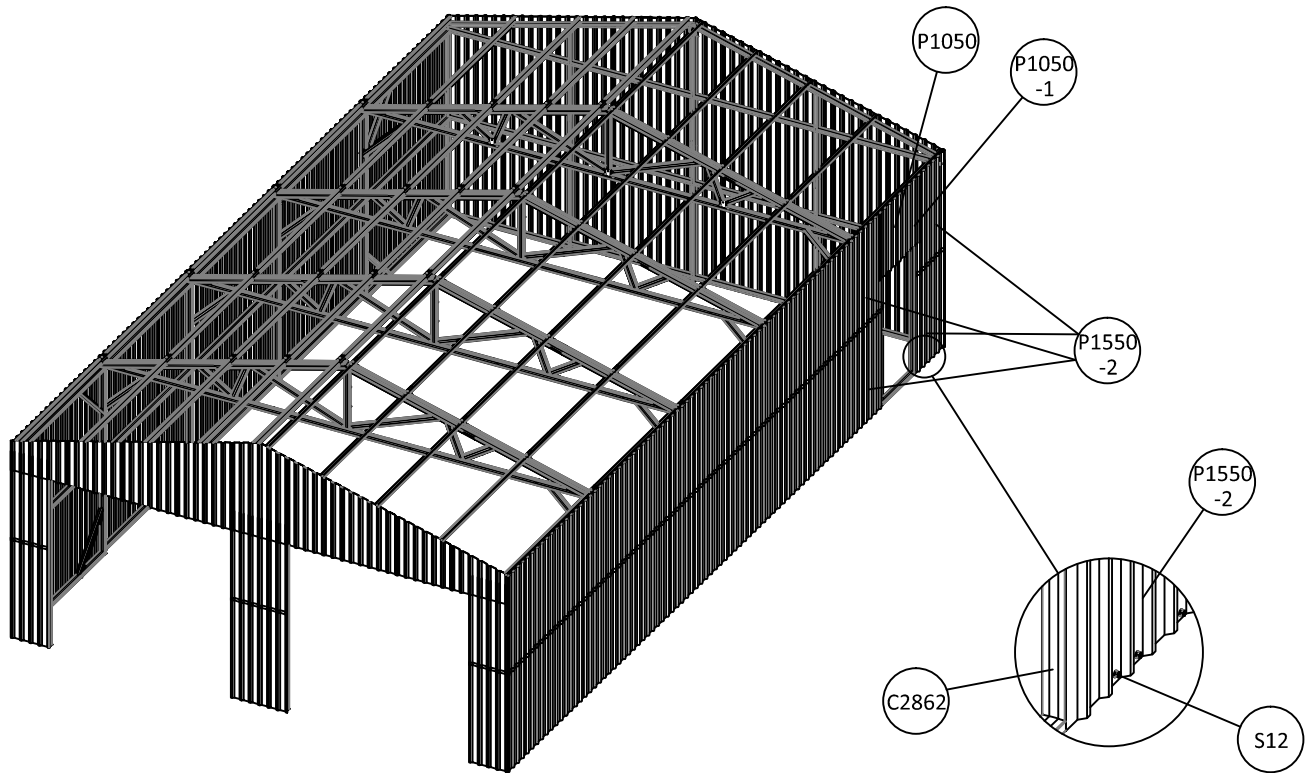

INSTALLATION WALL TILE



	P1550 -2	4		P1050	1		P1050 -1	1		S12	26
---	-------------	---	---	-------	---	---	-------------	---	---	-----	----

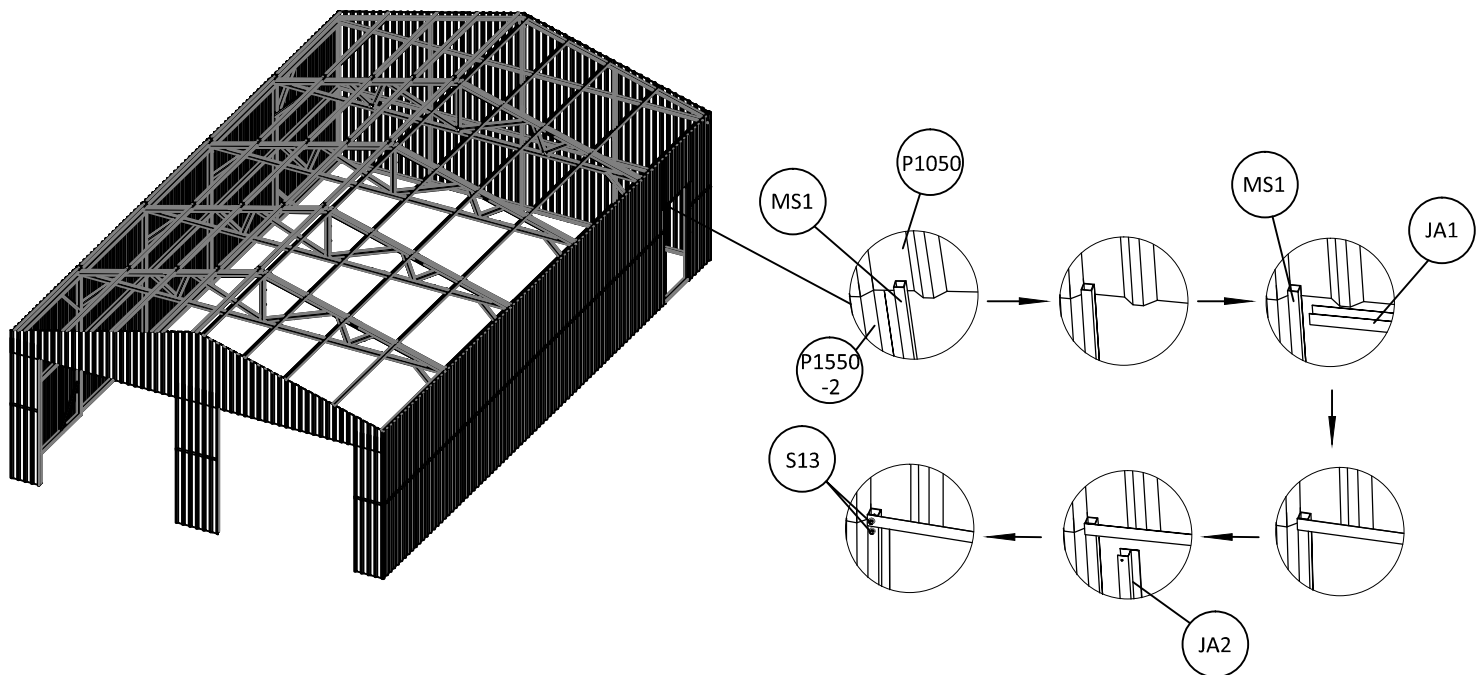

	JA1	1		JA2	2		MS1	2		S13	13
---	-----	---	---	-----	---	---	-----	---	--	-----	----



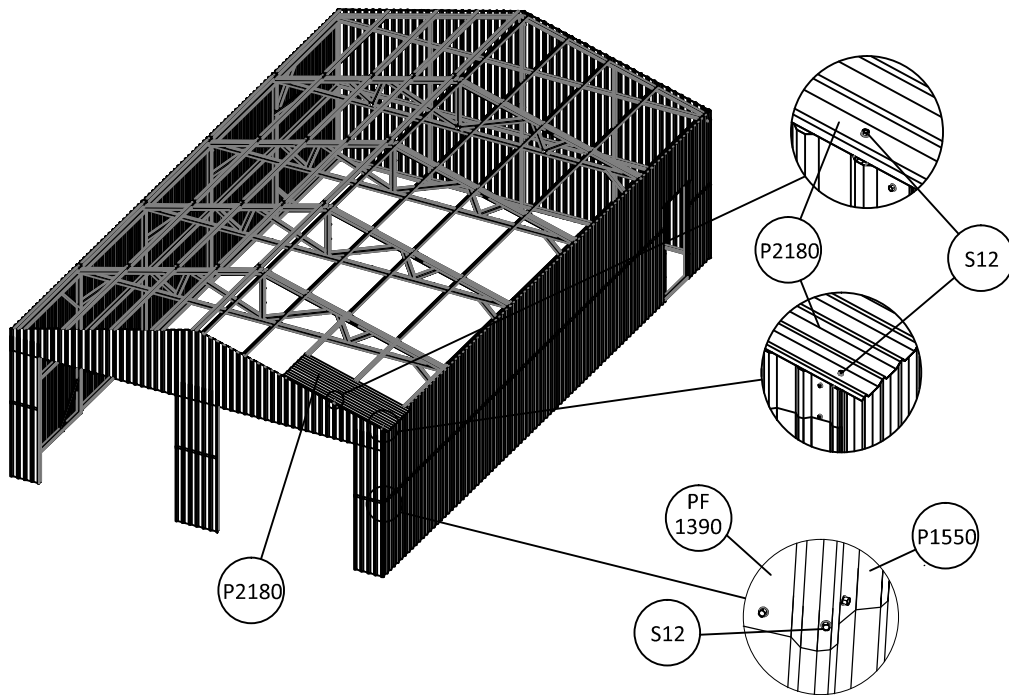

INSTALLATION WALL TILE

	P2180	1		S12	20
---	-------	---	---	-----	----





TIPS: To install transparent panels, please refer to page 51.

As shown in the figure, the four corners of the house are fixed with screws S12.

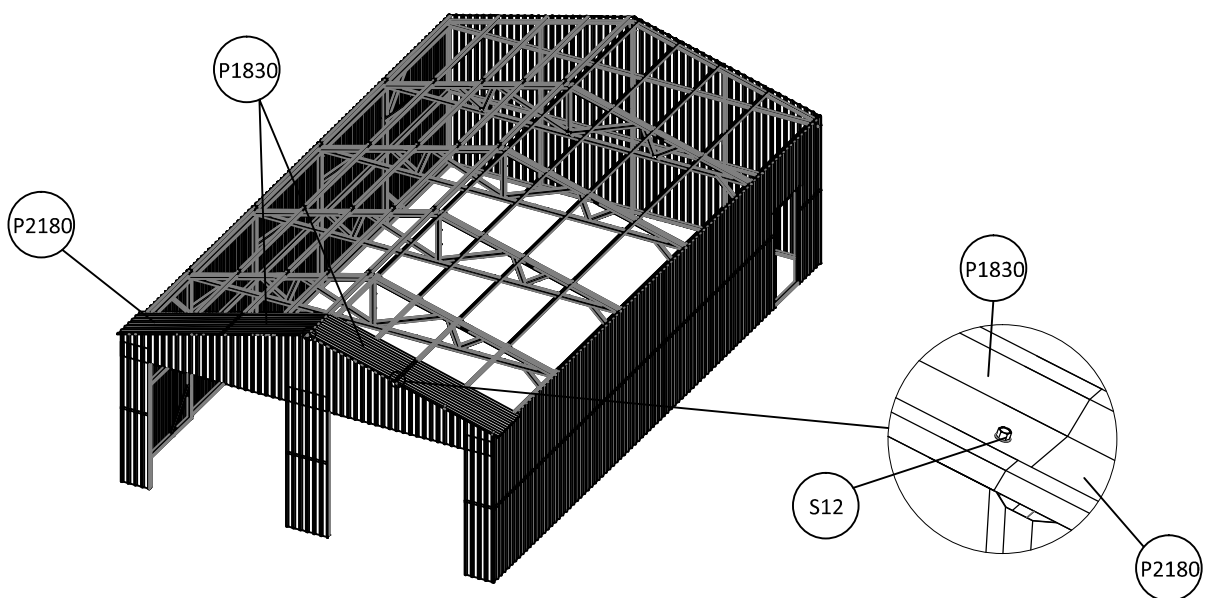
	P1830	2		P2180	1		S12	32
---	-------	---	---	-------	---	---	-----	----





INSTALLATION WALL TILE

	R877	1		S12	2		UV3	1
---	------	---	---	-----	---	---	-----	---

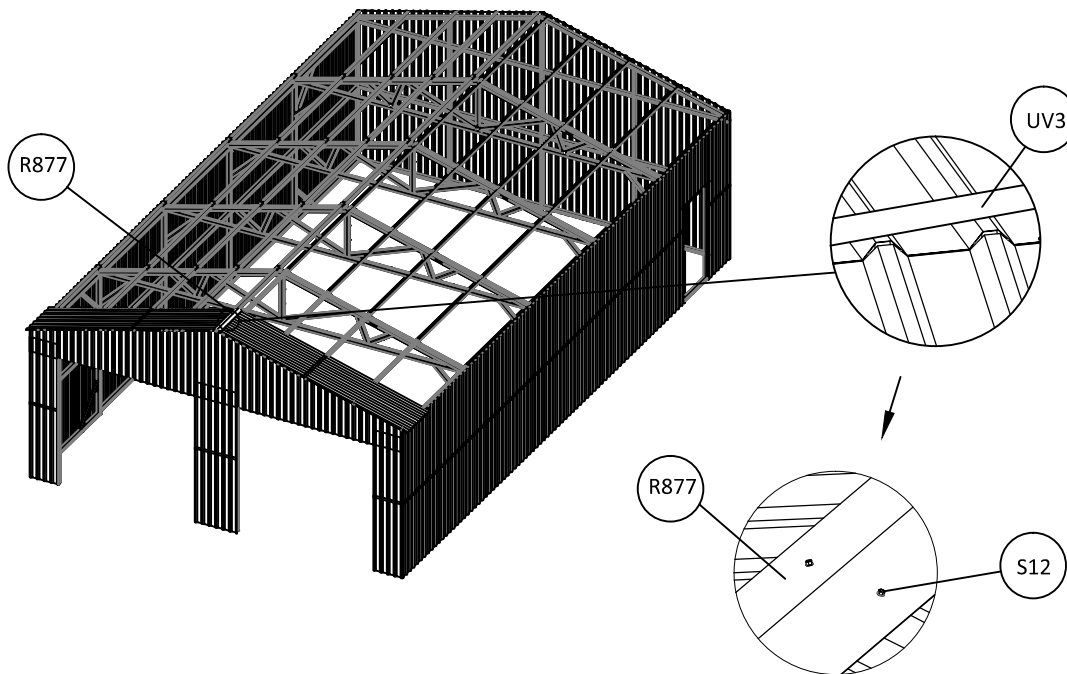

As shown in the figure, first stick a layer of waterproof tape at the joint of the two panels, and then install the ridge.



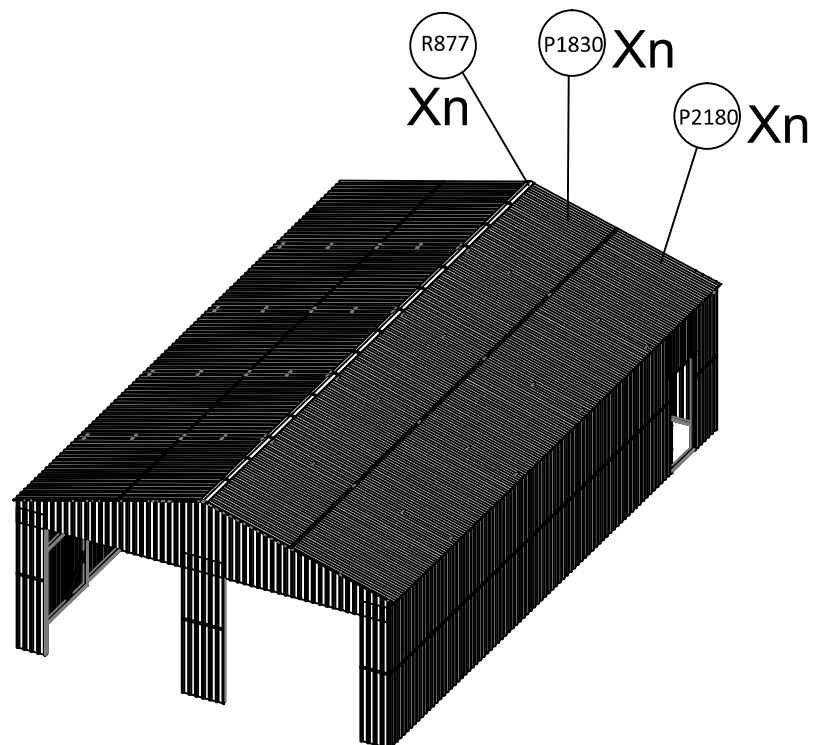

	P2180			P1830	
MODEL	n	S12	MODEL	n	S12
MS2525	16	128	MS2525	16	192
MS2533	22	176	MS2533	22	264
MS2541	28	224	MS2541	28	336
	R877		TIPS: Select the quantity corresponding to the table for assembly according to model.		
MODEL	n	S12			
MS2525	8	16			
MS2533	11	22			
MS2541	14	28			

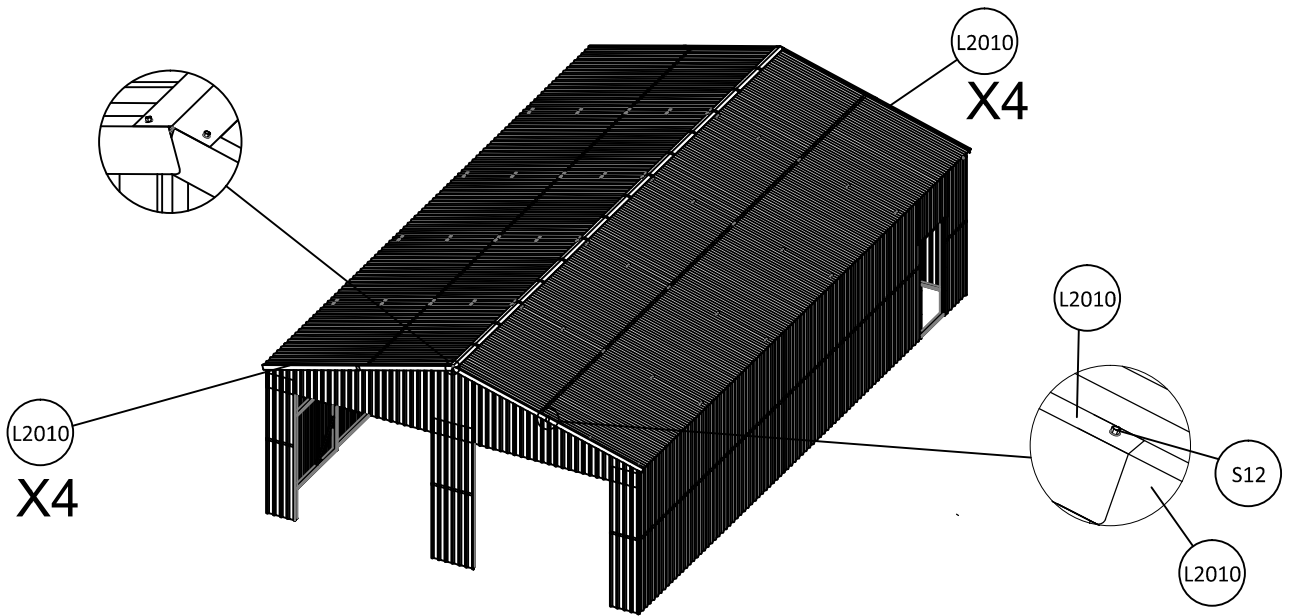

INSTALLATION WALL TILE

	L2010	8		S12	20
---	-------	---	---	-----	----





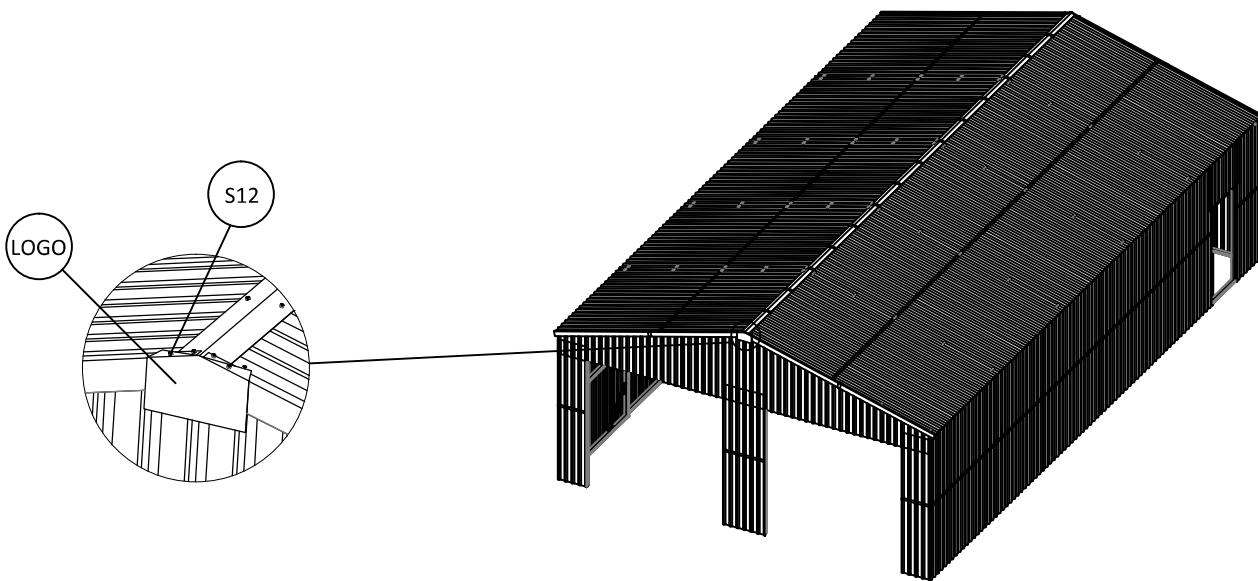

	LOGO	2		S12	4
---	------	---	---	-----	---

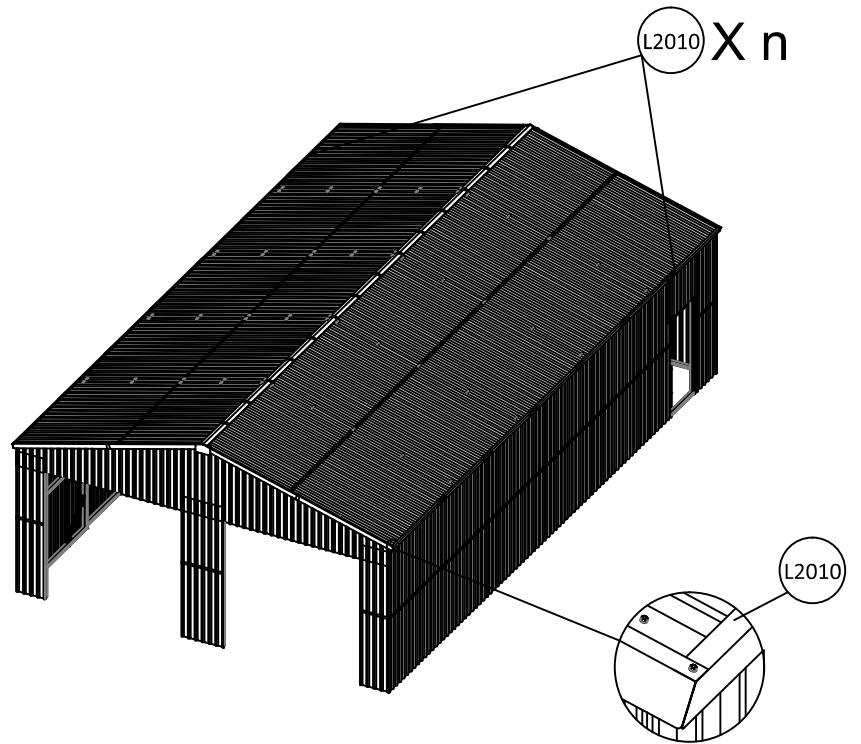

INSTALLATION WALL TILE

	L2010	
MODEL	n	S12
MS2525	8	18
MS2533	12	26
MS2541	14	30



	U2619	4		U2780	2		S12	24
---	-------	---	---	-------	---	---	-----	----

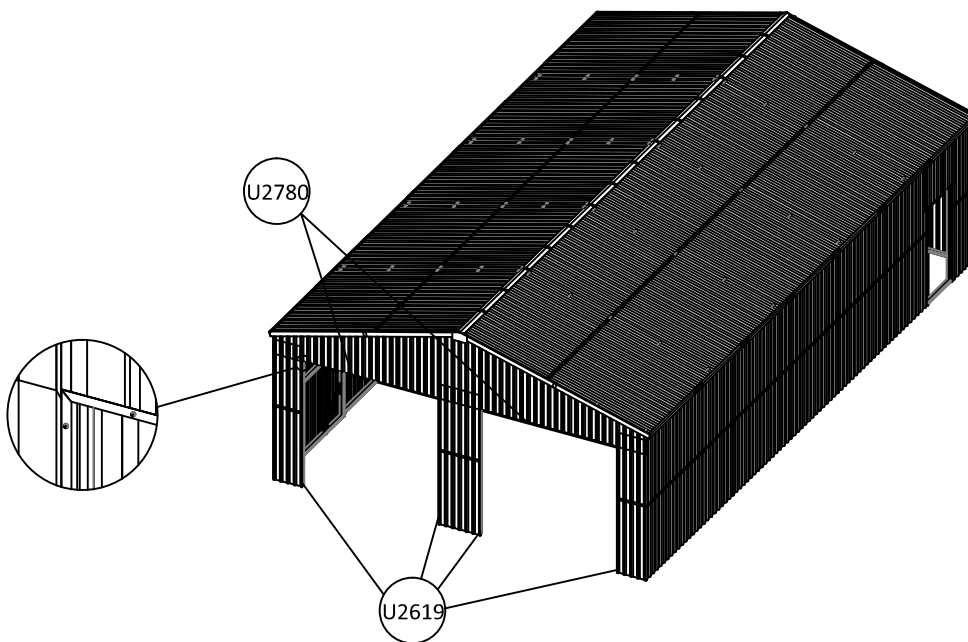

DOOR ASSEMBLY

STEP 1.

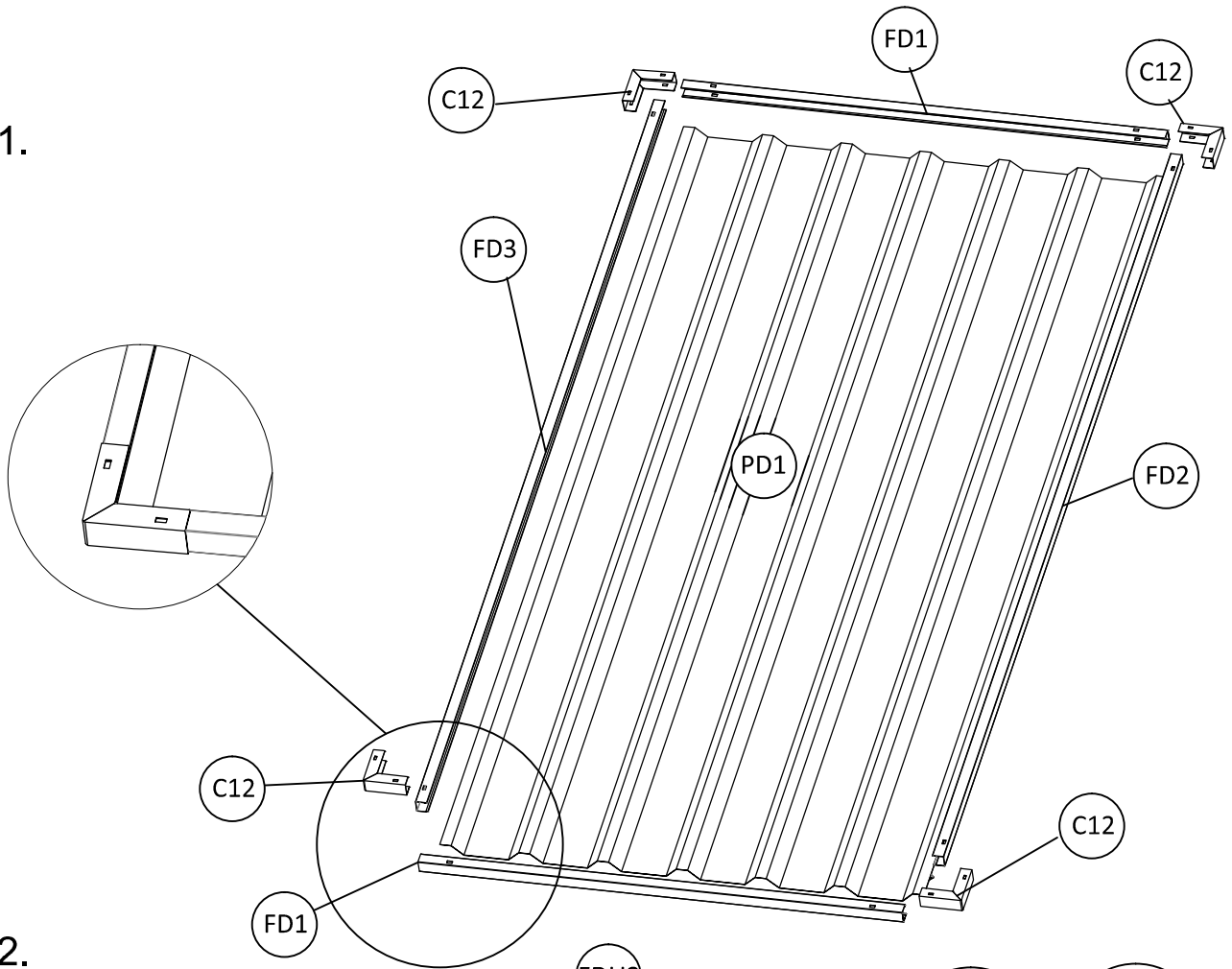



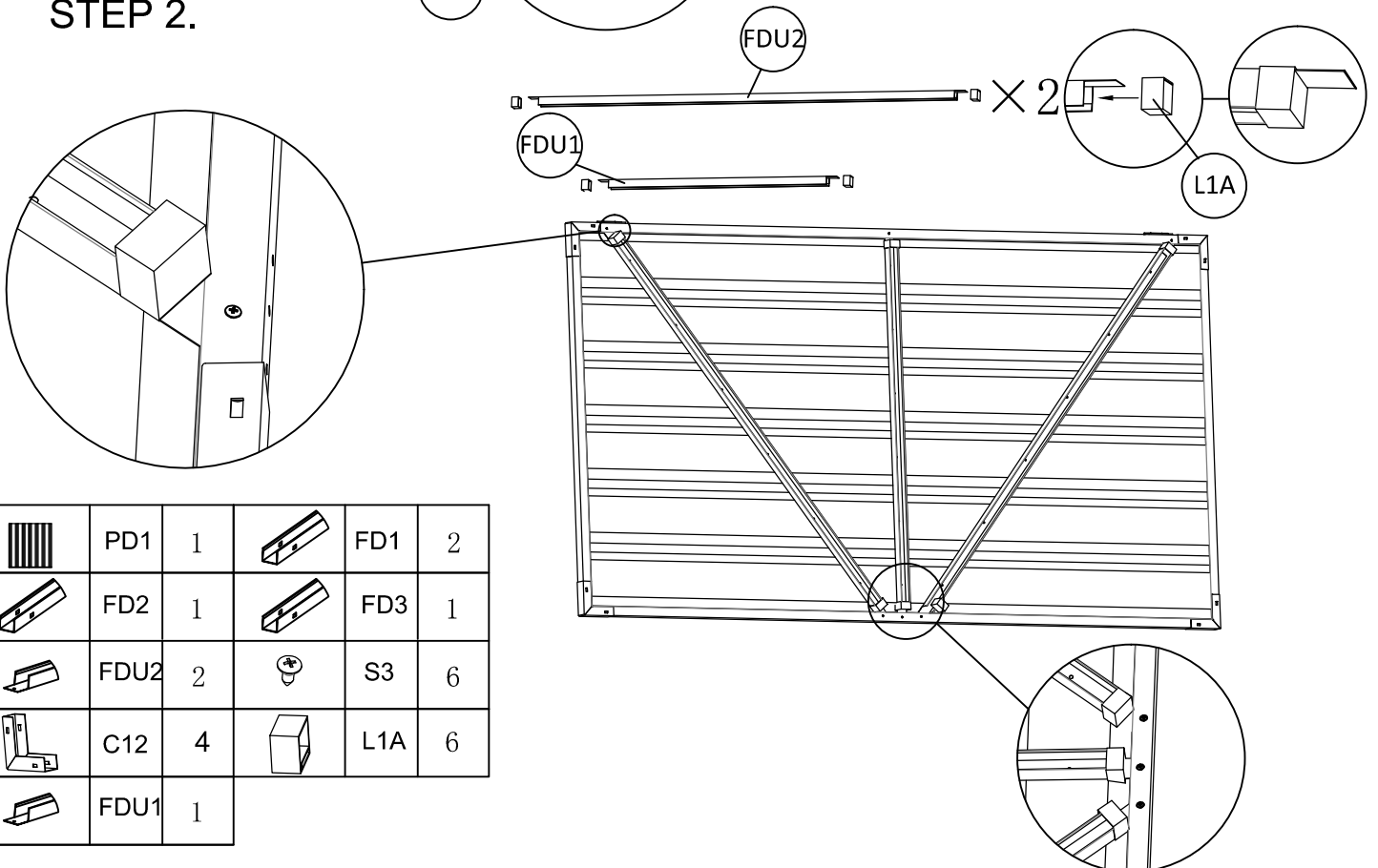

STEP 2.

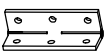

	PD1	1		FD1	2
	FD2	1		FD3	1
	FDU2	2		S3	6
	C12	4		L1A	6
	FDU1	1			

DOOR ASSEMBLY

STEP 3.

	SH1	2		S3	18
	S7	6		L3	18
	S5	18			

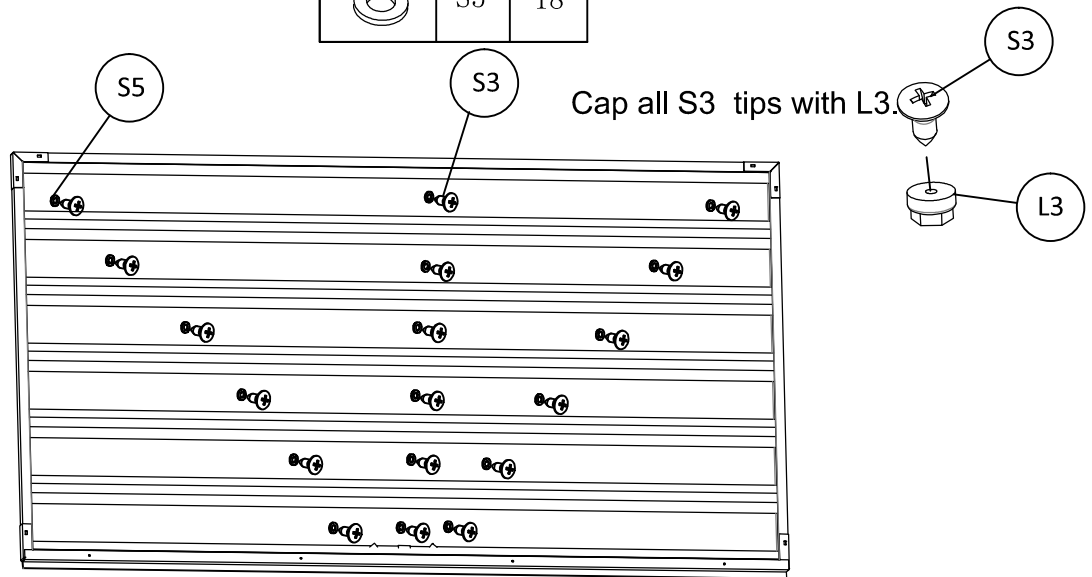

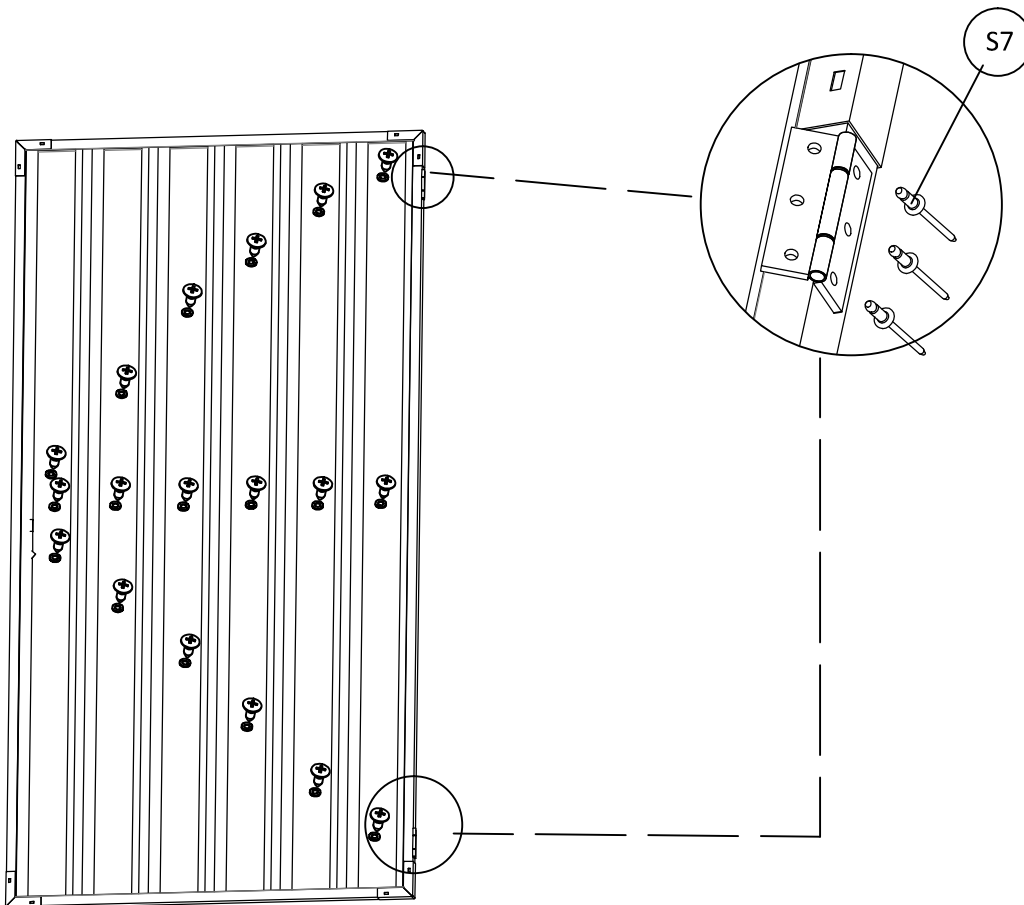

STEP 4.

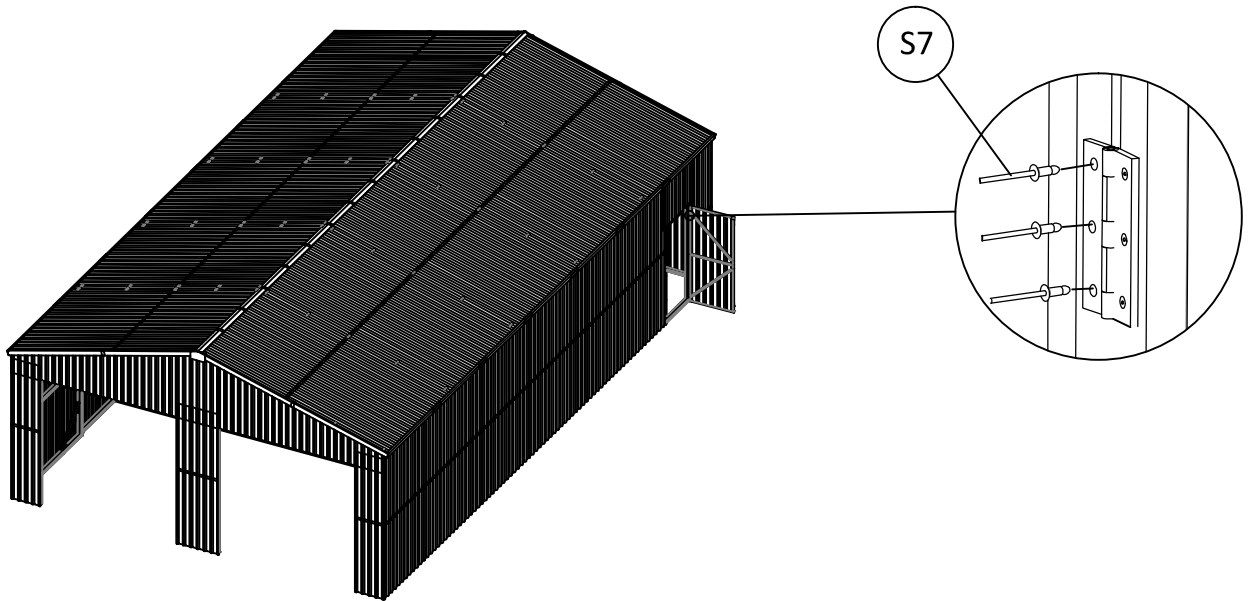

DOOR ASSEMBLY

	S7	6
---	----	---



	H13	1
	S7	6

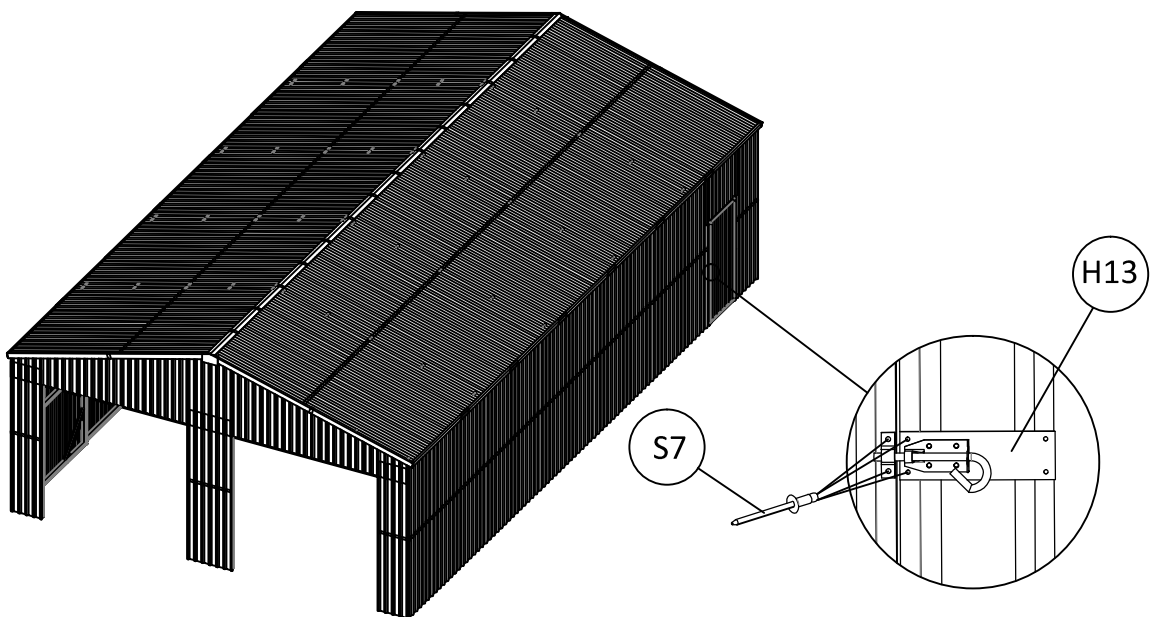

ASSEMBLY OF ROLLER DOOR (OPTIONAL)

ASSEMBLY OF THE DOOR MAY REQUIRE THE FOLLOWING PARTS

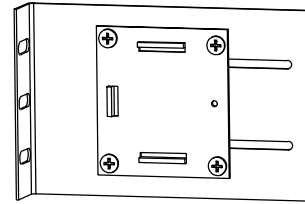
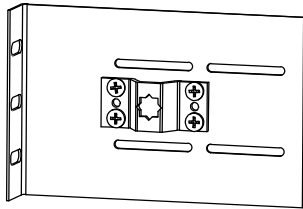

A

B

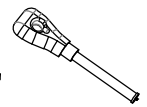
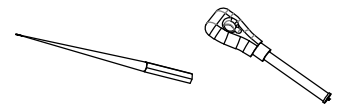
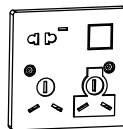
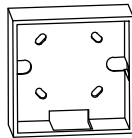
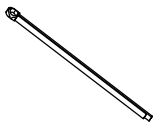

C

D

E

F

H

I

J

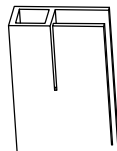

K

L

GR1

GR2



S12

S13

ASSEMBLY OF ROLLER DOOR

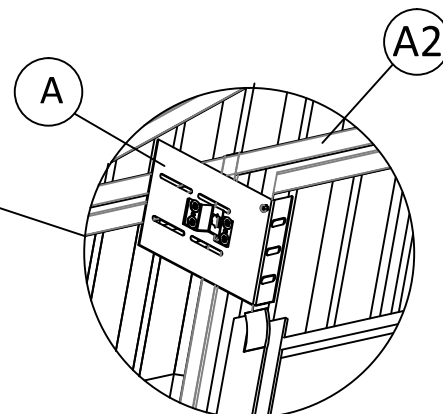
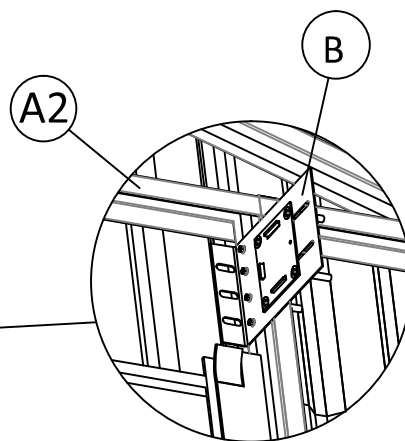
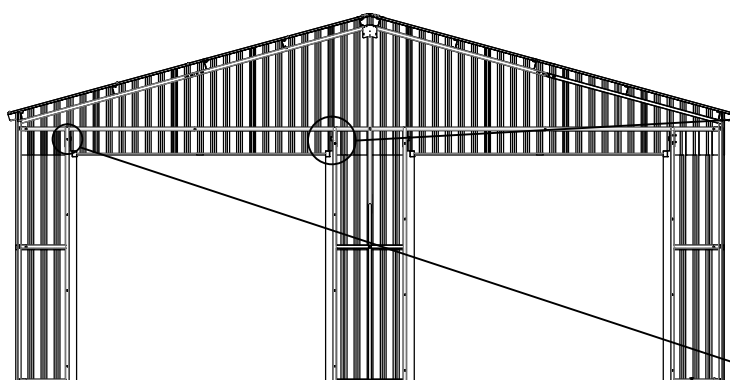
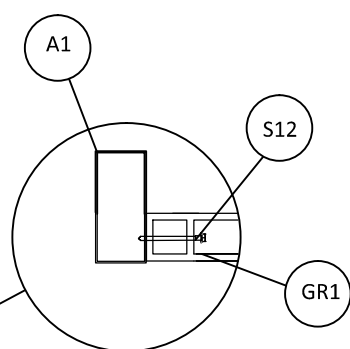
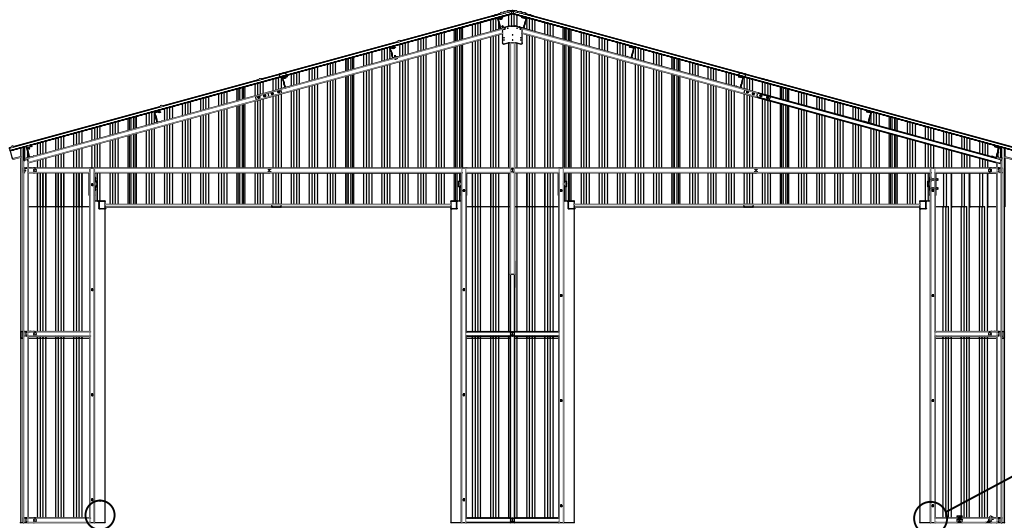
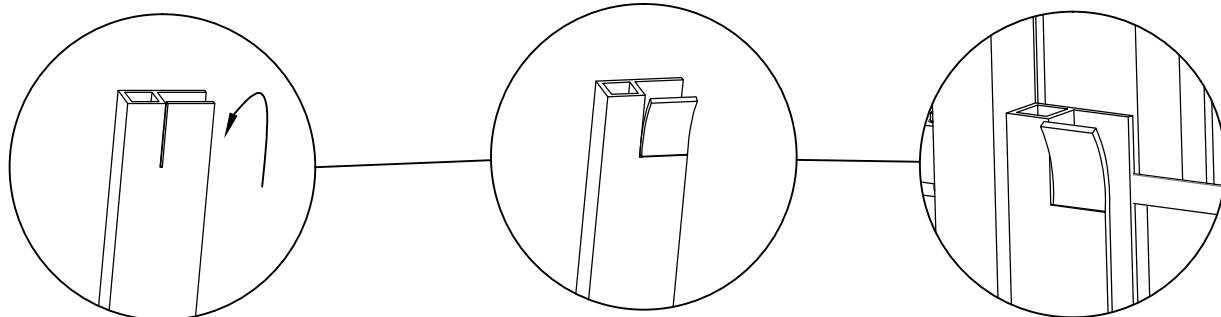

ASSEMBLY OF ROLLER DOOR

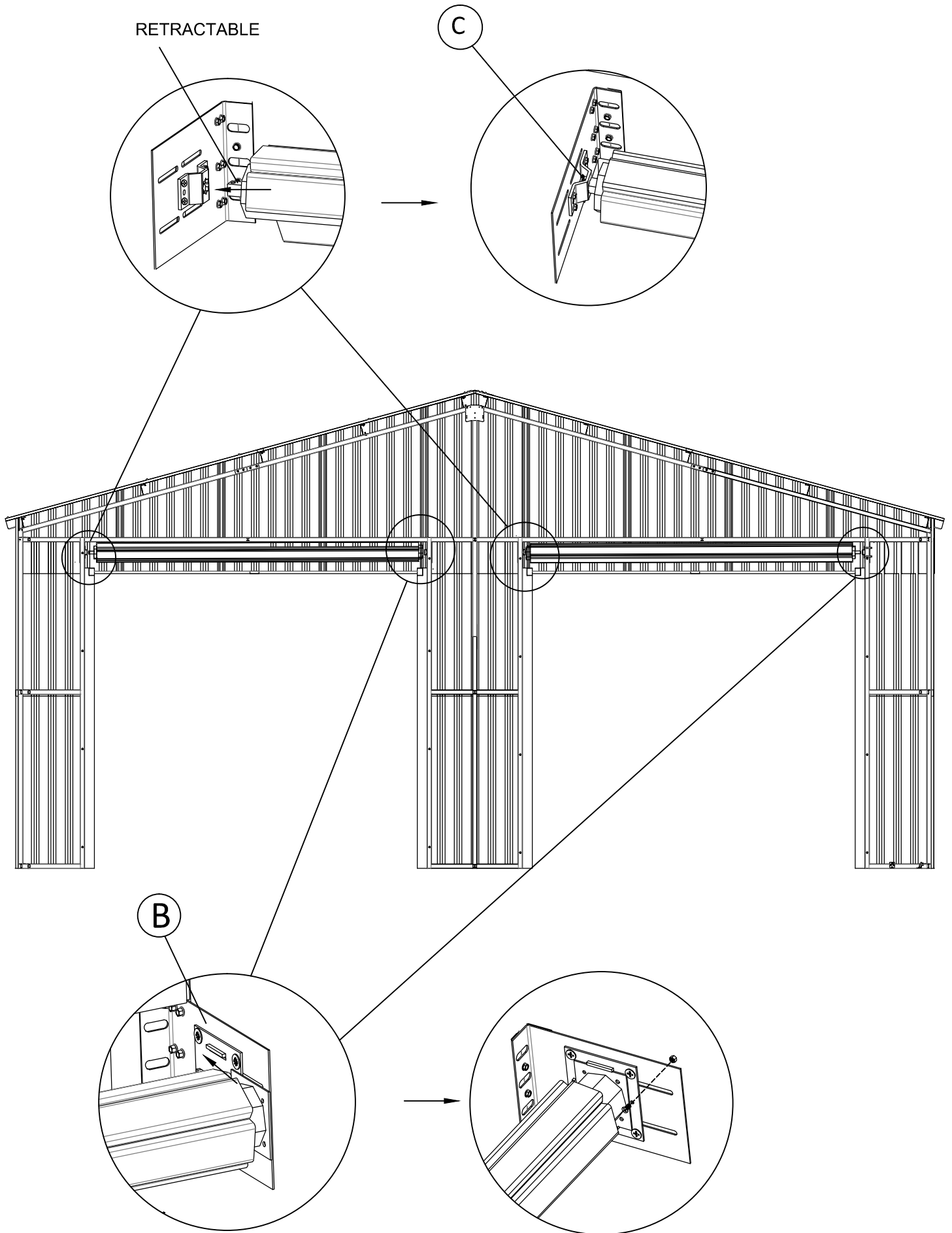

ASSEMBLY OF ROLLER DOOR

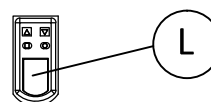
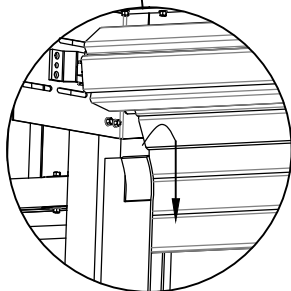
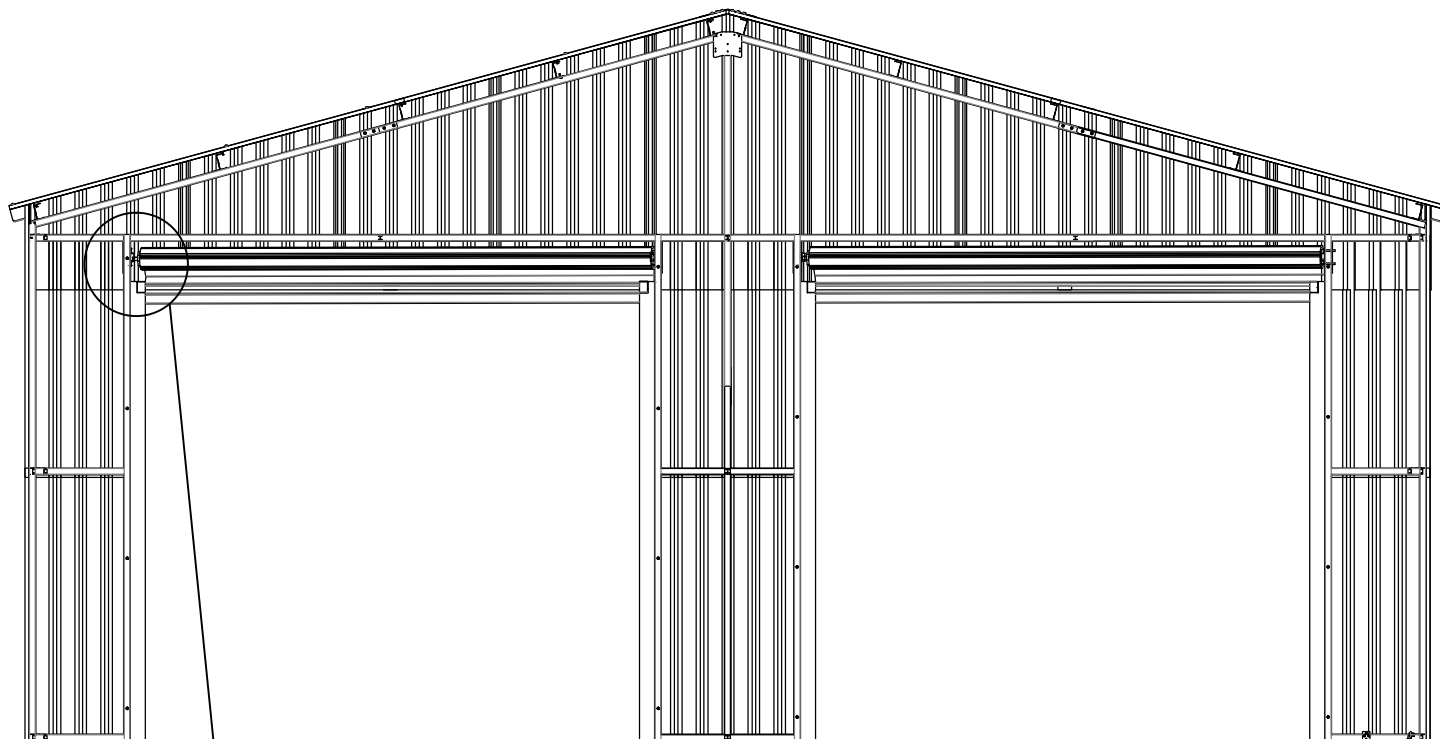
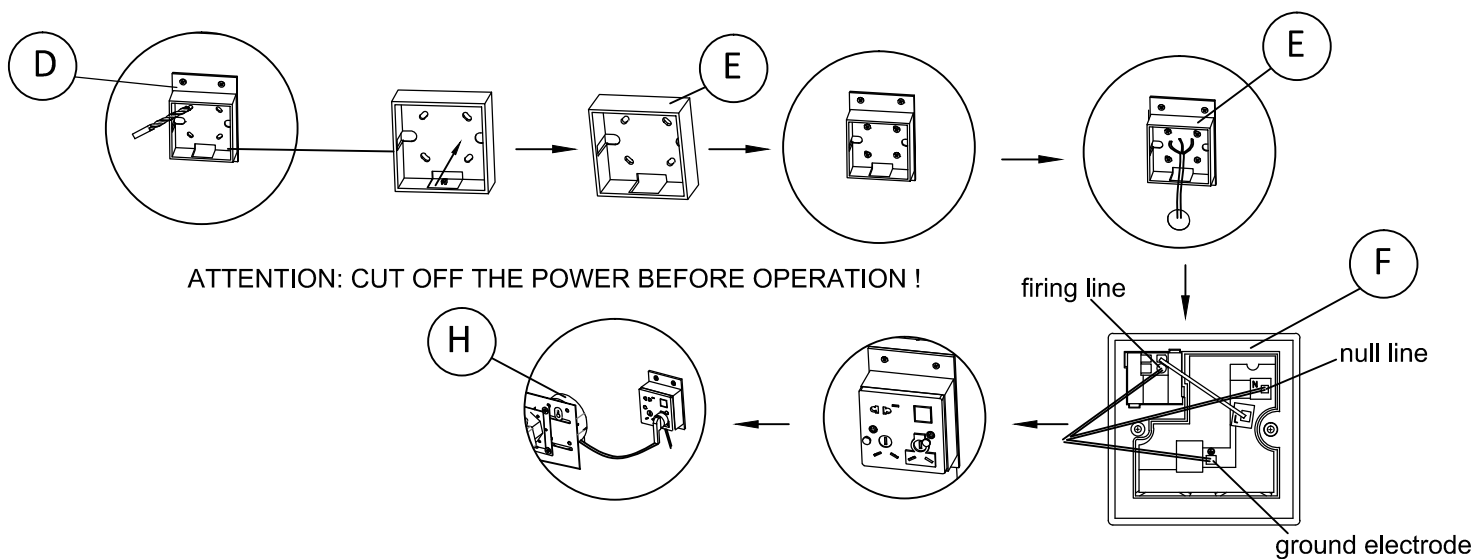

POWER-ON, THEN
CONTROL THE REMOTE
CONTROL, SLOWLY INSERT
THE ROLLER DOOR INTO
GR1 AND GR2.

ASSEMBLY OF ROLLER DOOR

1. ADJUST THE LOWER LIMIT

Assume that C is the direction in which the roller door goes down. Press the downward button on the remote control, the roller door goes down. If the electrical machine stops rotating when it reaches the position in picture D, adjust A to rotate in the direction of "+" until the roller door is parallel to the ground. If the electrical machine is still rotating downward when the roller door touches the ground, press the stop button, adjust A to rotate in the direction of "-".

2. ADJUST THE UPPER LIMIT



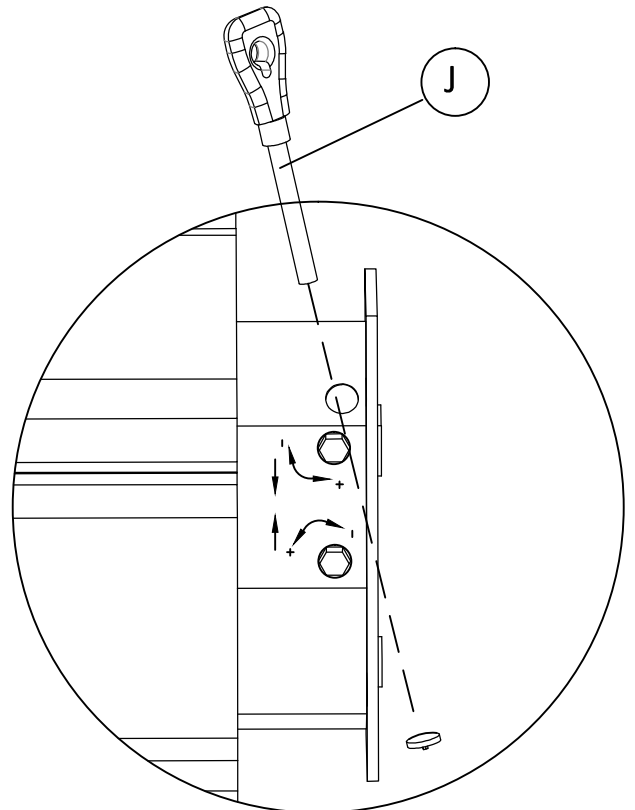
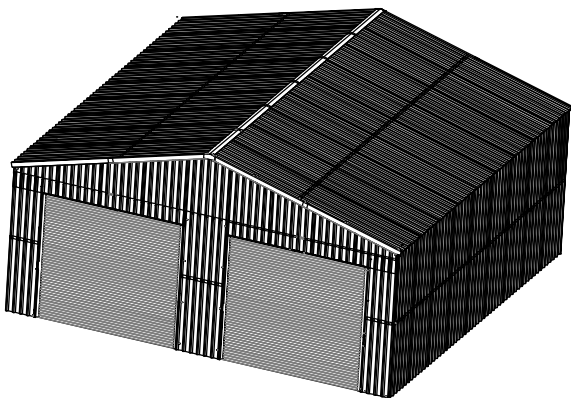
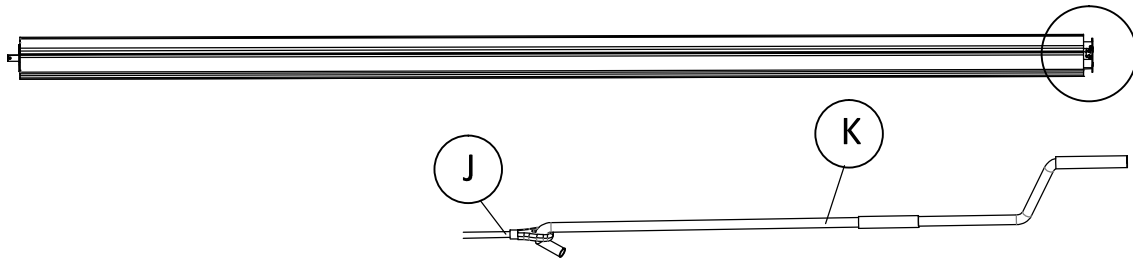
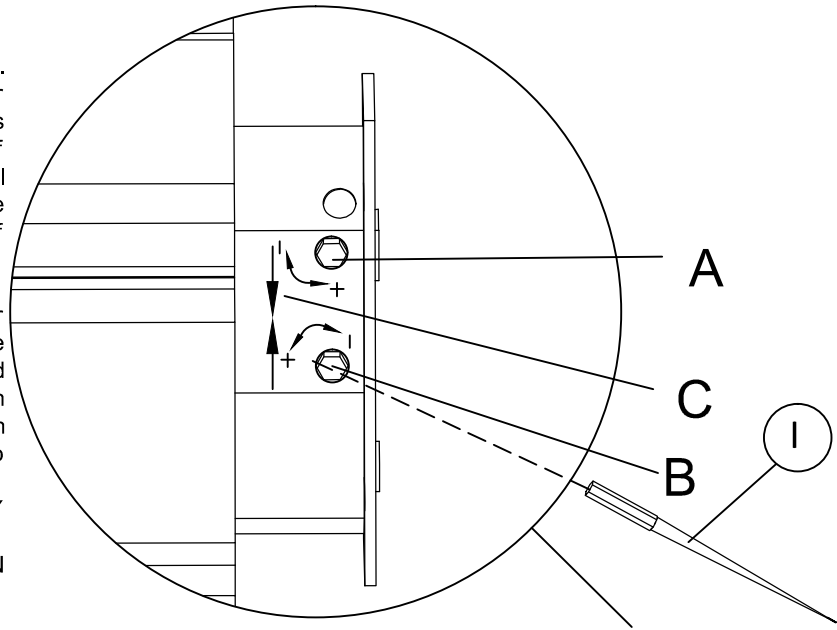

Press the upward button on the remote control, The roller door goes up. If the electrical machine stops rotating when it reaches the position in picture E, adjust B to rotate in the direction of "+", and pay attention not to slipping off the guide rail until it gets an appropriate position. If the roller door is still operating upward when it gets the appropriate position, press the stop button, adjust A to rotate in the direction of "-".

3. ADJUST THE UPPER AND LOWER LIMIT REPEATEDLY UNTIL IT OPERATES SMOOTHLY.

4. ROTATE THE ROLLER DOOR WITH THE ROCKER (IN PICTURE J) WHEN POWER CUT.



INSTALLATION FRAMEWORK

	JA1	1		JA2	2		MS1	2		S13	13
---	-----	---	---	-----	---	---	-----	---	---	-----	----

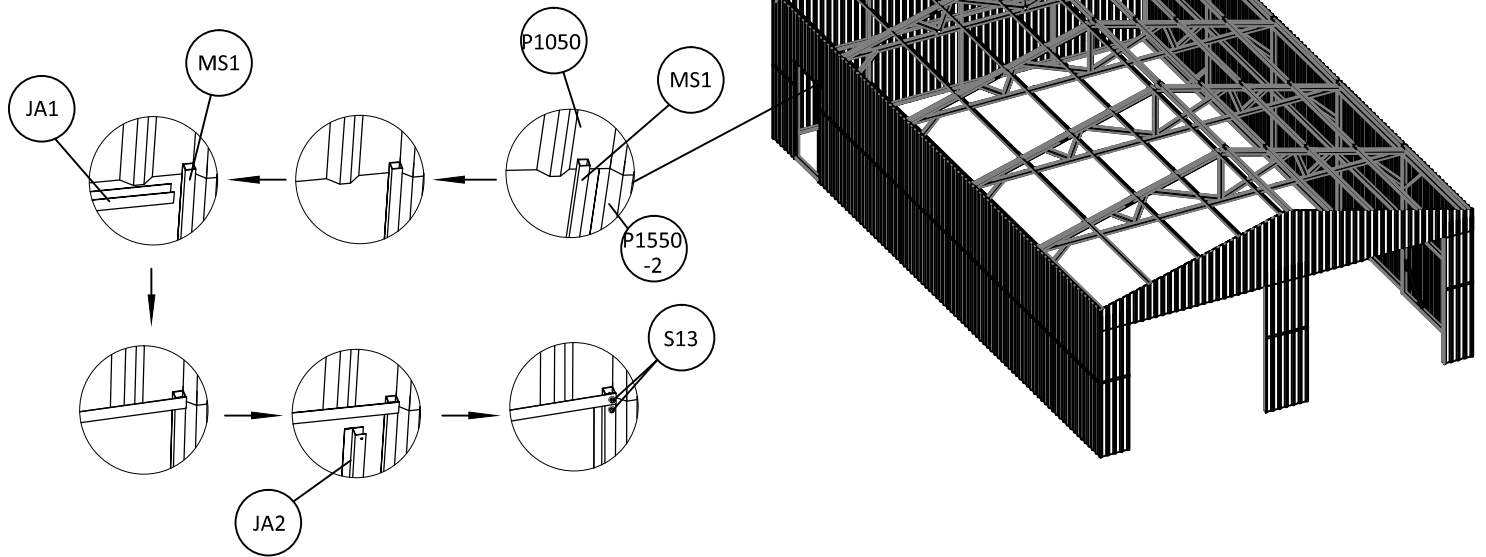

INSTALL TRANSPARENT PANEL

Correct Demonstration

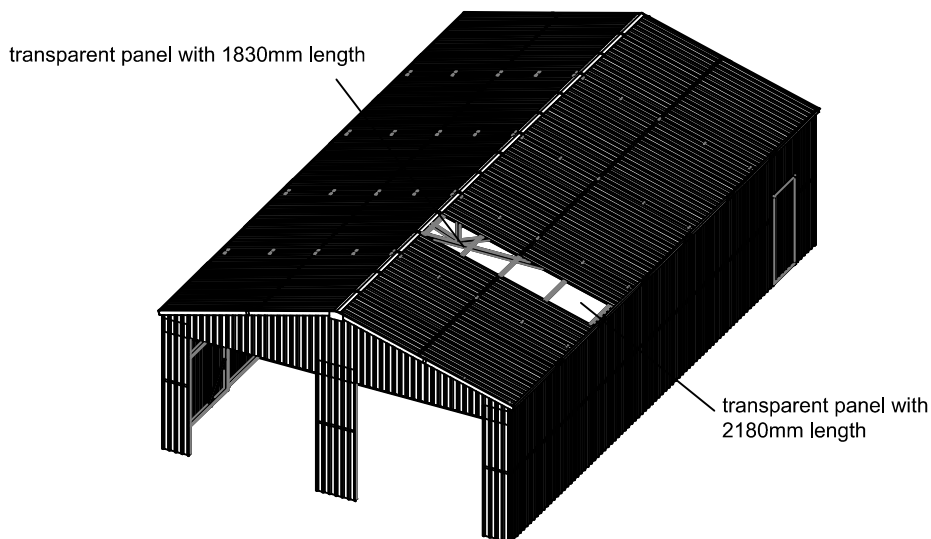

The blank space is where the transparent panels are installed. Please install them according to the correct position. The two transparent panels are stacked together. Incorrect installation will cause water leakage. Please pay special attention.

Error Demonstration

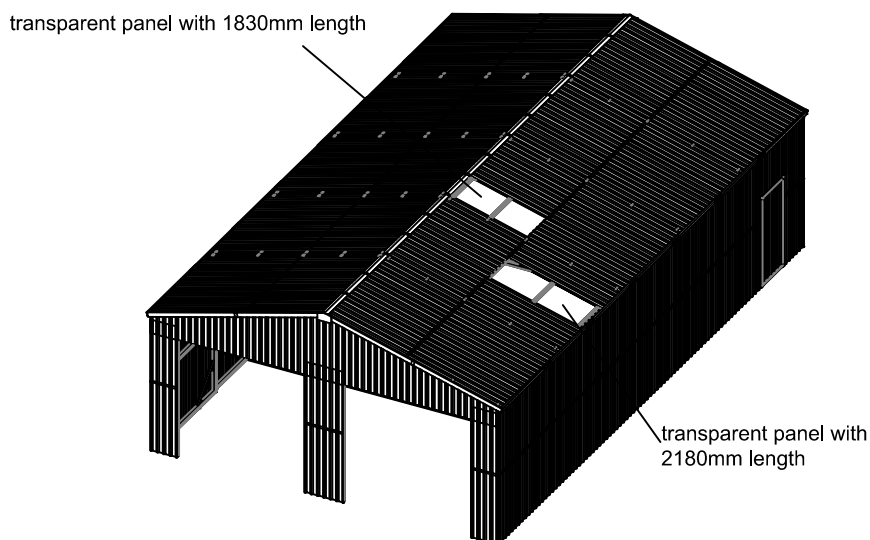

Tip: After this step, please go back to page 37 to continue the installation.

WARRANTY INFORMATION:

Please refer to our website for detailed warranty conditions and coverage. For the most up-to-date and comprehensive warranty information, visit www.tmgindustrial.com