

# Double Garage Metal Shed

Model:TMG-MS2119



Please read the instructions **COMPLETELY** before assembly.

· This double garage metal shed might not be suitable for local bylaws or weather conditions. It is the owner's responsibility to ensure the installation and use of this building are permitted by local authorities. Some municipalities may require engineering drawings to be submitted. It is the owner's responsibility to hire an engineer to submit drawings if required.







· Missing parts or questions on assembly?

Please call: 1-877-761-2819 or email: [cs@tmgindustrial.com](mailto:cs@tmgindustrial.com).

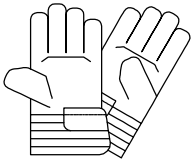
Do not return the product to dealer, they are not equipped to handle your requests.

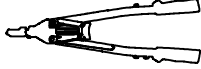
# BEFORE YOU START

## Items Required:

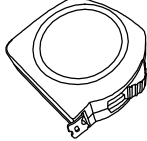































Safety Gear				
	gloves	Safety Glasses	Shoes	Riveting Gun
Tools				
	Power drill	Screw drive	Pencil	Tape Measure

- Clear a working area to allow access on 4 sides. A raised work surface will make assembly easier.
- Please choose a dry and calm day to start assembly. Do not attempt installation in rainy or windy day.
- **Keep roof clear of leaves and snow with long handled, soft-bristled broom. Heavy amounts to snow on roof can damage building, making it unsafe to enter.**
- All parts are identified so when working through the instructions page by page the diagrams show where each part is positioned.
- Before starting, to avoid any accidental injury, we recommend the use of gloves to protect your hands, safety glasses to protect your eyes and shoes or boots to protect your feet.
- Some holes have been pre-punched, using self-tapping screws to fix.
- Please keep children away from your construction site.
- Most assembly can be completed by one person, assistance may be needed when you reach the erection stage.
- Cleaning should be performed as often as is required to remove any dirt, salt, and pollutants.
- Please note: Some local government authorities have rules & regulations on shed installation and you may need approval to erect this shed.















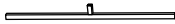
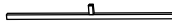

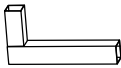
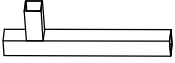









### STEPS:

1. Unpack all components from the carton and lay outside your work area and check parts against the part list on the next page.
2. Work through assembly instructions Page by Page
3. Use anchors to fix the garage to the ground.
4. Clean up all metal pieces, rivets and screws.

# PART LIST













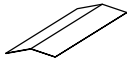







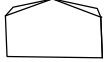

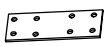

Picture	Name	QTY	Check	Picture	Name	QTY	Check
	P1A	8			P1B	4	
	P2A	10			P2B	4	
	P3A	1			P4A	2	
	P4B	1			P5A	4	
	P5B	2			P6A	2	
	P6B	1			P7A	14	
	P8A	14			P9A	2	
	P9B	1			PD1	1	
	PA1	2			PA2	2	
	PA3	2			PA4	2	
	PA5	2			PB4	2	
	PB3	2			PB2	2	
	PB1	2			P2B1	1	
	FG1	6			FG2	4	
	FG3	8			FG4	1	
	FD1	2			FD2	1	

# PART LIST

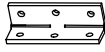
Picture	Name	QTY	Check	Picture	Name	QTY	Check
	FD3	1			FDU1	1	
	FDU2	2					
	A1A	2			A1B	2	
	A2A	2			A2B	1	
	A3A	2			A3B	2	
	A3C	2			A3D	1	
	A1895	18			A905	2	
	A2150	3			AS2	10	
	AS4	5			AS3	10	
	A1835	1			A1225	2	
	B1490	4			B270	2	
	B1432	12			B1467	12	
	MSG	2			MSH	1	
	L1A	8			L1B	6	
	Z1	4			Z2	2	



# PART LIST

Picture	Name	QTY	Check	Picture	Name	QTY	Check
	W1	8			TE2	1	
	R1A	3			TE1	2	
	JA	11			S1	28	
	S12	1398			S13	60	
	L3	18			L1A	6	
	LGG	2			S7	18	
	S16	18			MSA	2	
	C3	30			C22	28	
	C52	6			C62	12	
	C72	14			SH1	2	
	S11	14			H1	1	
	S15	4			CG1	1	
	Waterproof tape	1			C12	4	



# FRAME ASSEMBLY

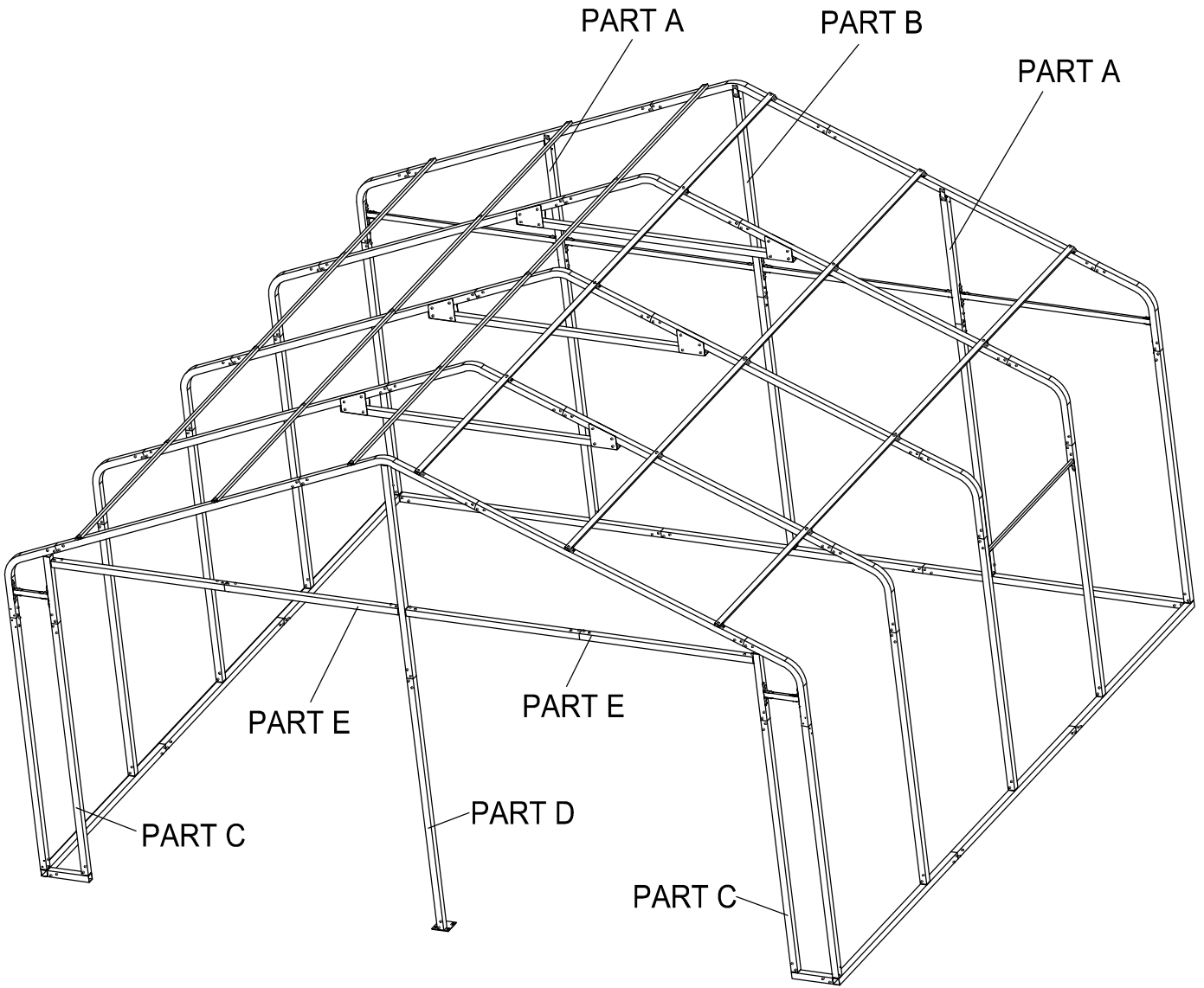

# BEFORE WELDING

□	A1895	8	□	A1225	2	□	A3C	2	□	A3D	1
□	A905	2	□	A1835	1	⚙	S12	28			

## STEP 1

when you install the square tube, it will be much easier to adjust the angel first.

## STEP 2

## STEP 3

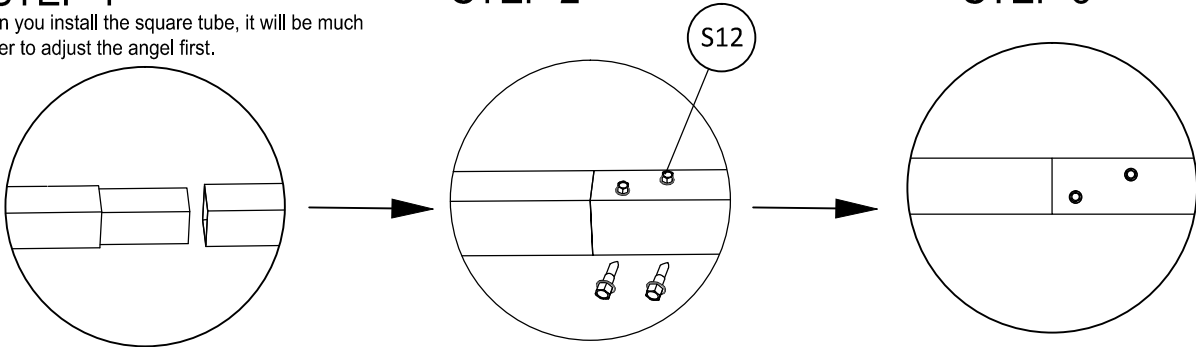

PART A × 2PCS



PART A = 3020mm

PART B × 1PCS



PART B = 3635mm

PART C × 2PCS

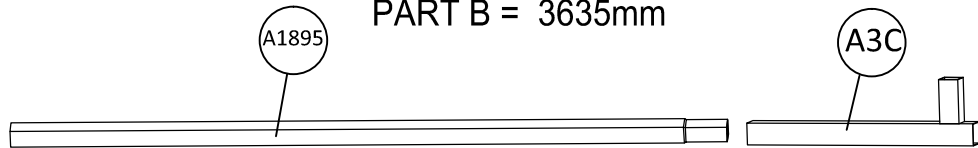

PART C = 2525mm

PART D × 1PCS

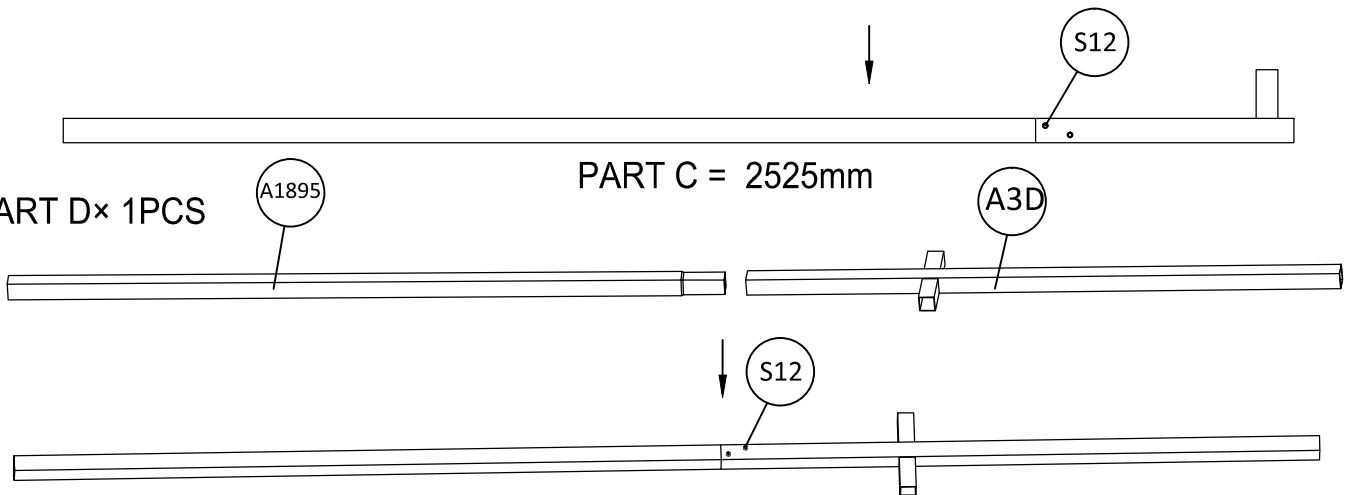

PART D = 3685mm





PART E × 2PCS



PART E = 2700mm



# FRAME ASSEMBLY - BACK WALL

## STEP 1

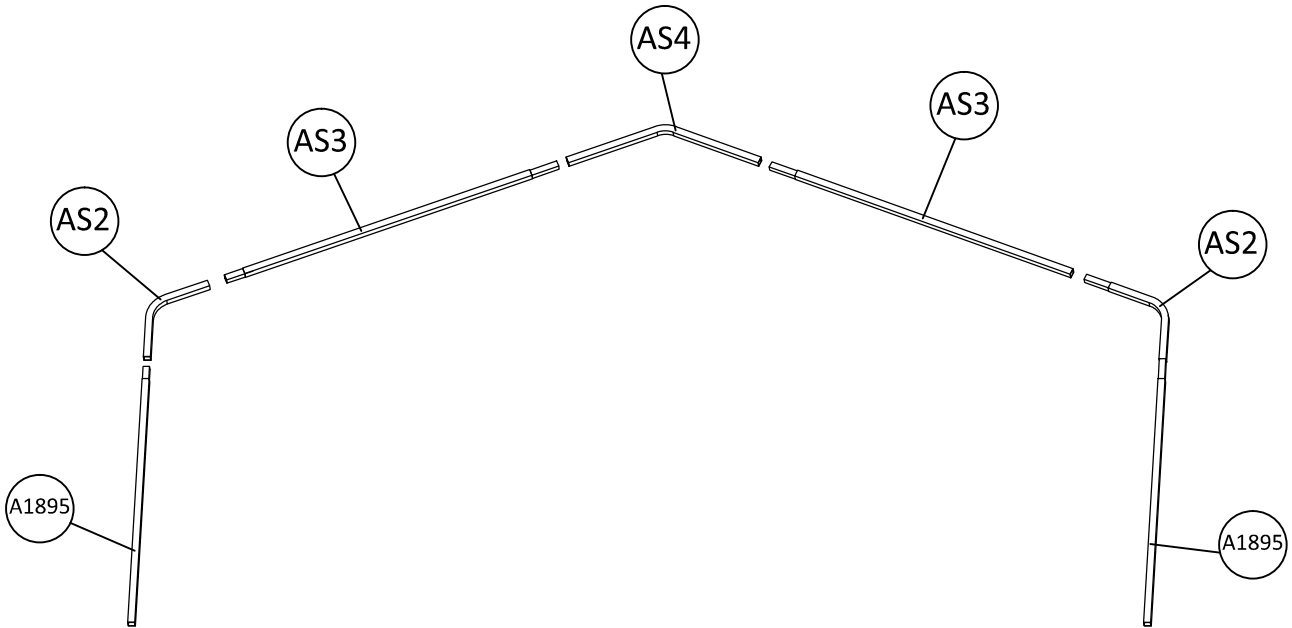
	A1895	2		AS2	2		AS3	2
	AS4	1		S12	24			



## STEP 2

	B1490	1		C22	4		S12	16
---	-------	---	---	-----	---	---	-----	----



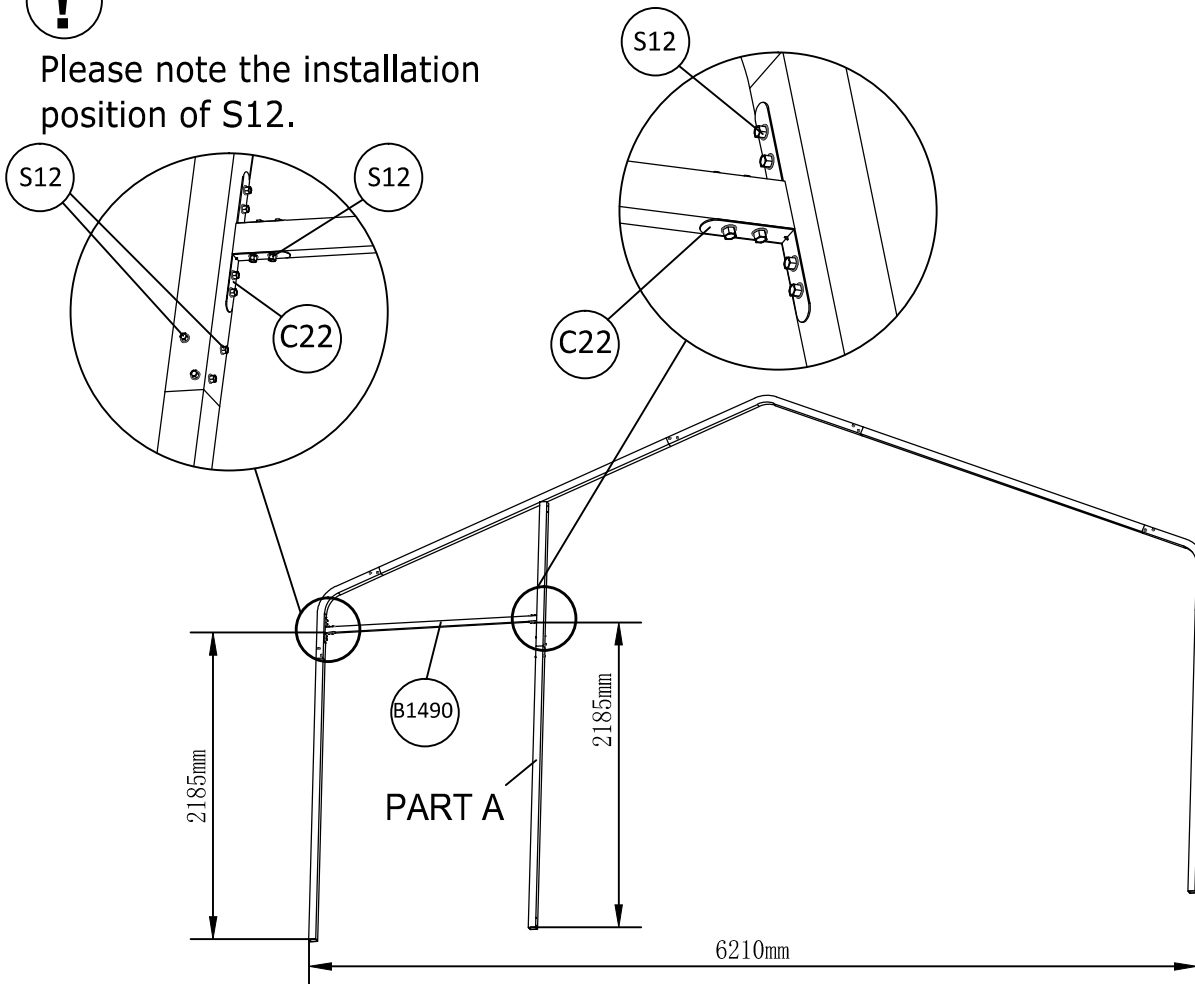

Please note the installation position of S12.



# FRAME ASSEMBLY - BACK WALL

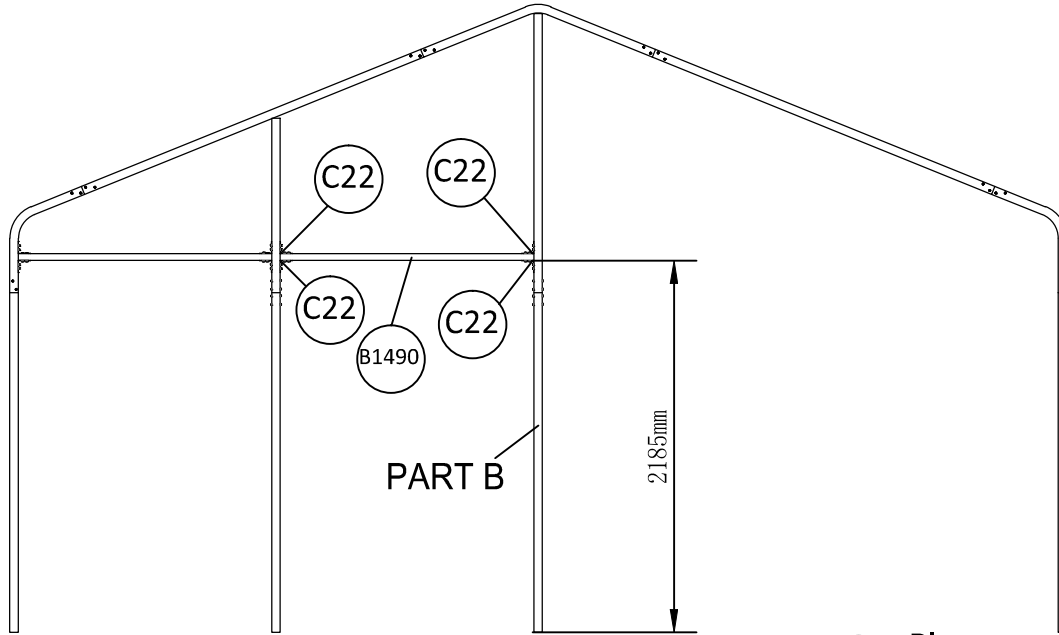

## STEP 3

	B1490	1		C22	4		S12	16
---	-------	---	---	-----	---	---	-----	----



**!** Please note the installation position of S12.

## STEP 4

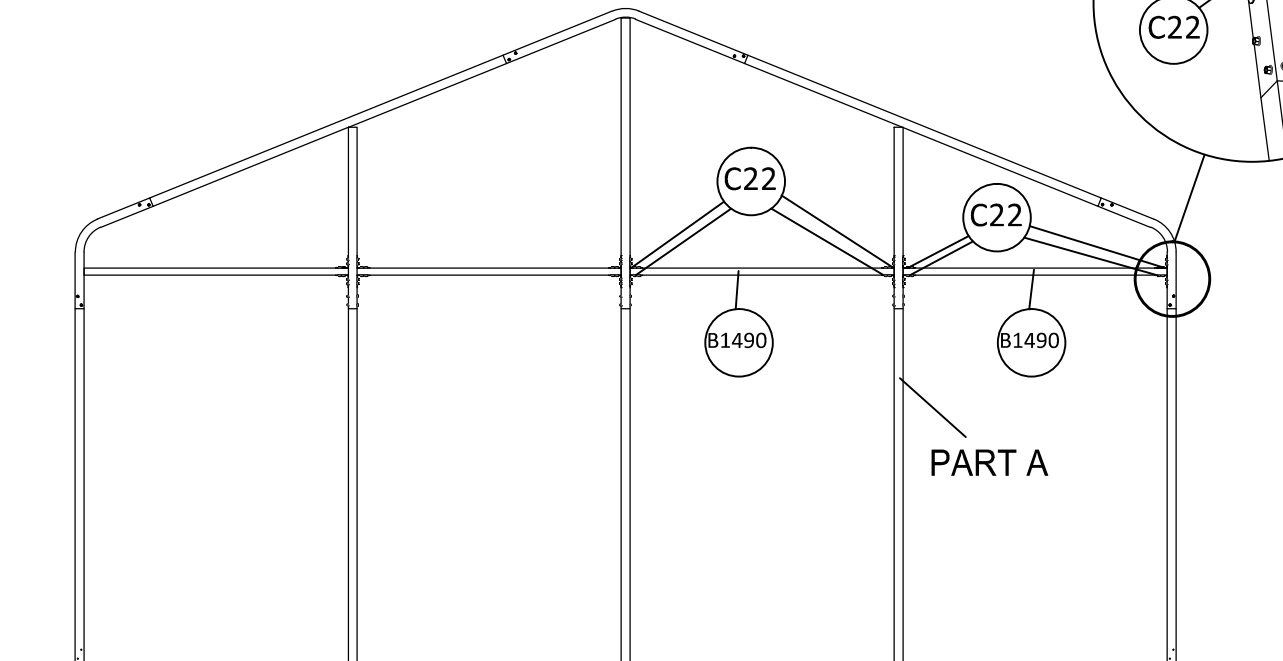

	B1490	2		C22	8		S12	32
---	-------	---	---	-----	---	---	-----	----



Make sure on the same level.

# FRAME ASSEMBLY - BACK WALL

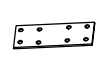

STEP 5

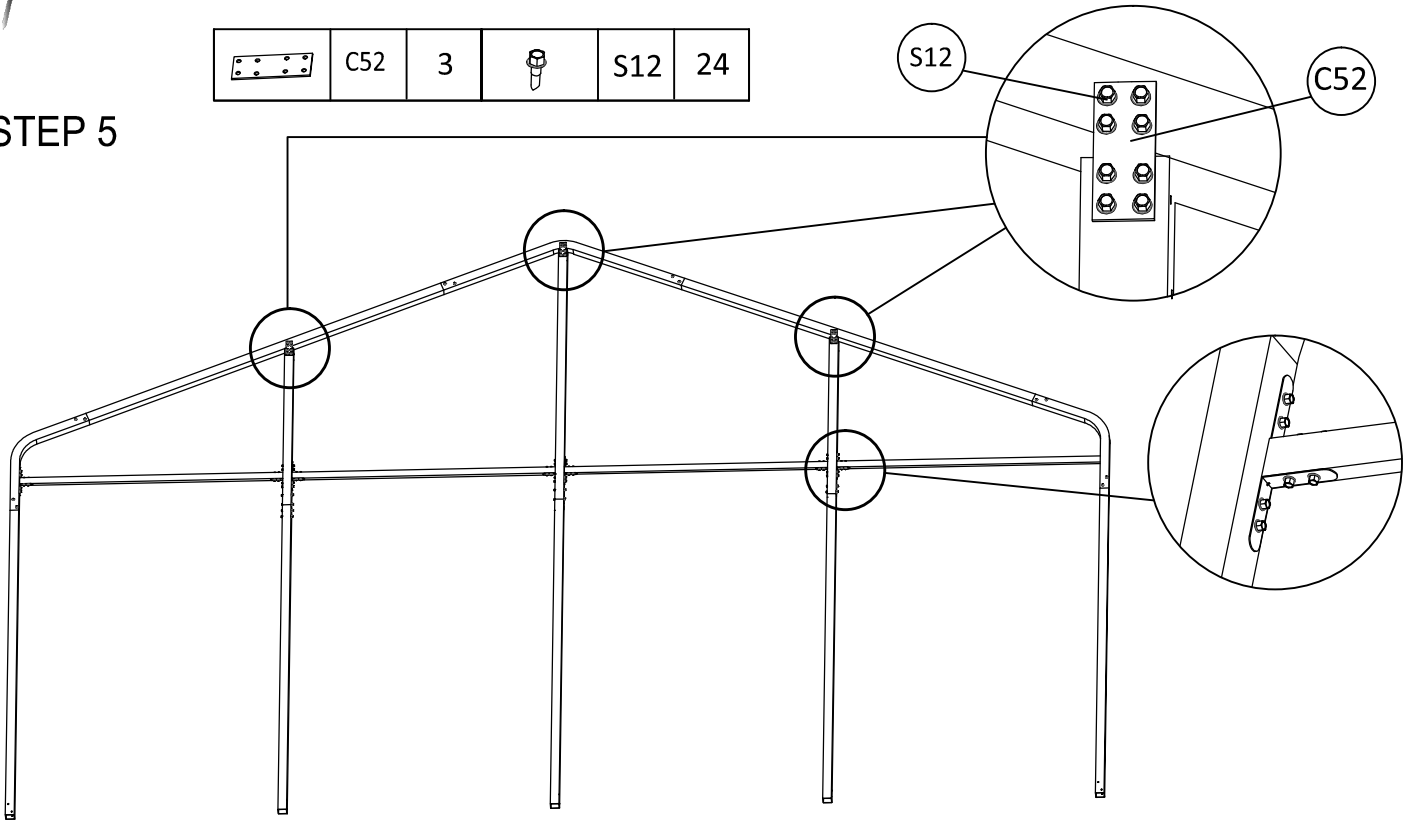
	C52	3		S12	24
---	-----	---	---	-----	----

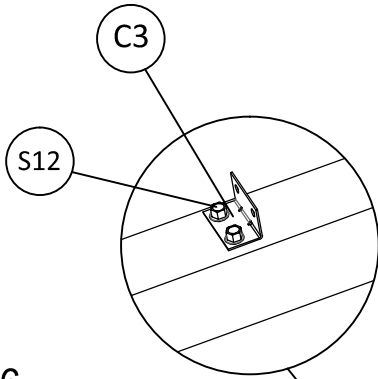

STEP 6





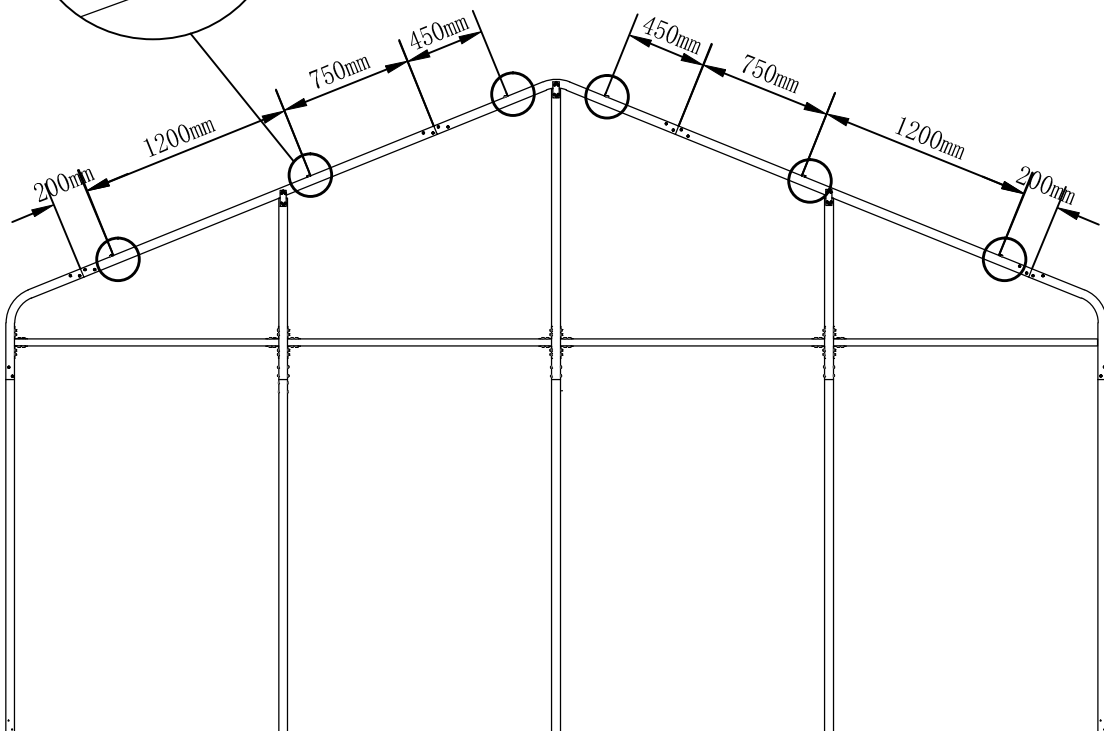

	C3	6		S12	12
---	----	---	---	-----	----



# FRAME ASSEMBLY - FRONT WALL

STEP 1

	A1895	2		AS2	2		AS3	2		AS4	1
	S12	24									

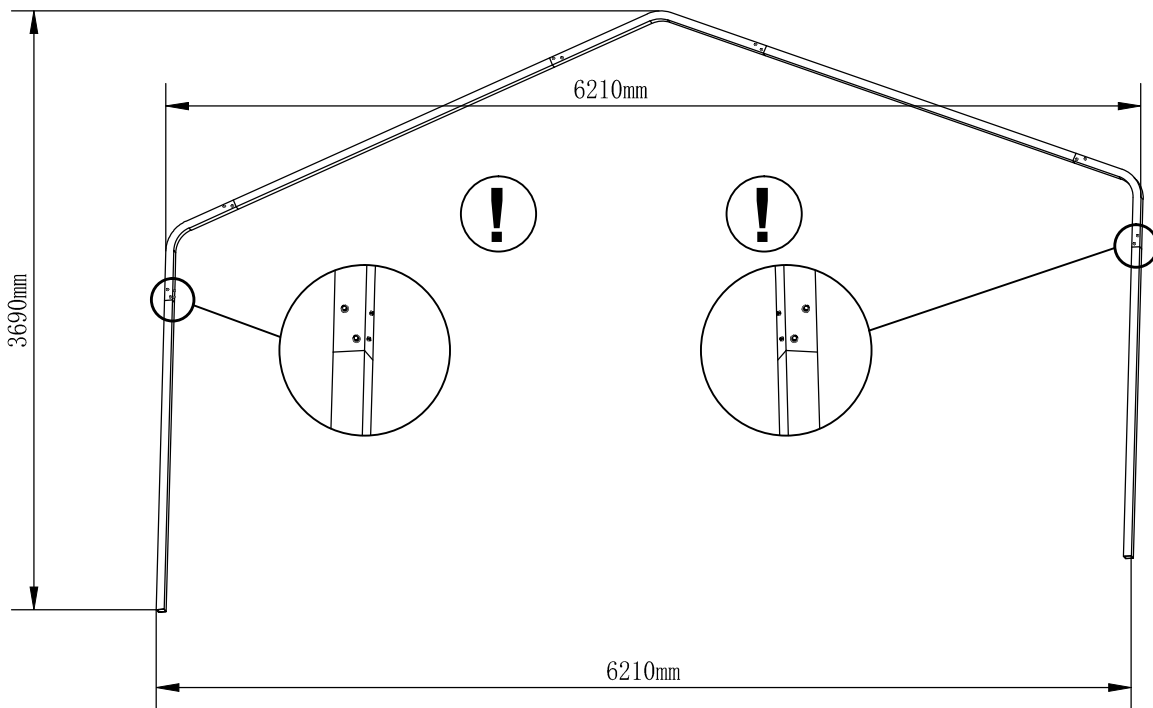
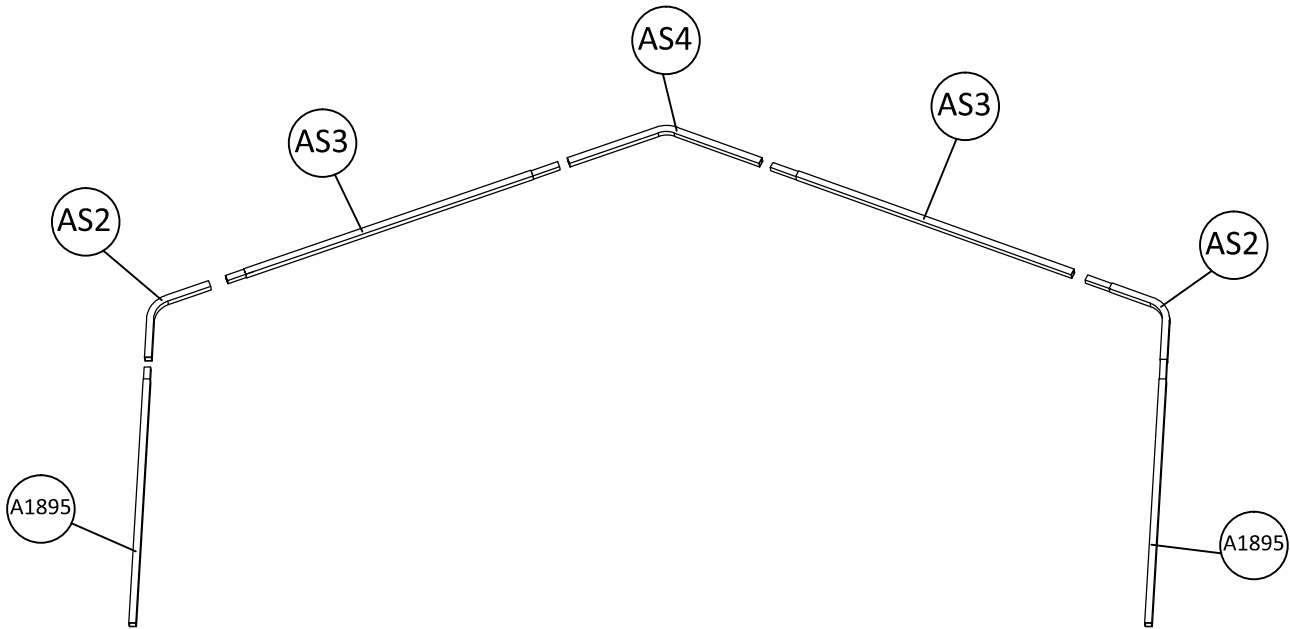



# FRAME ASSEMBLY - FRONT WALL



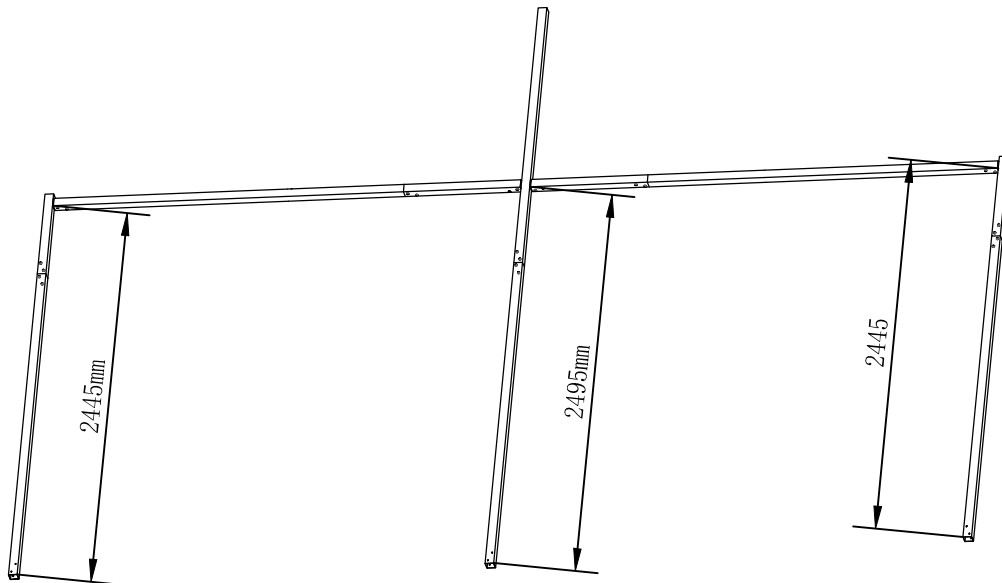
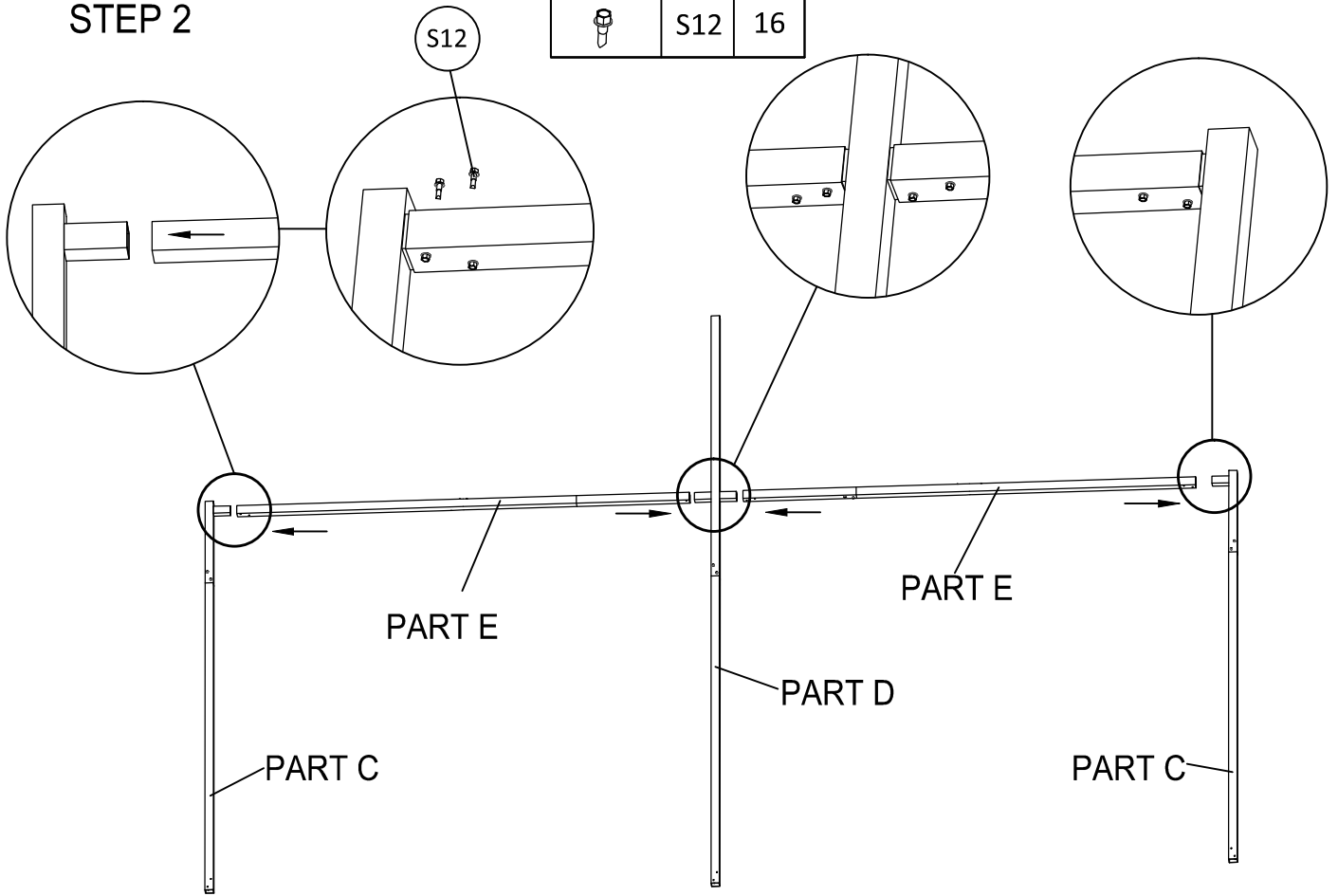

STEP 2

	S12	16
---	-----	----





# FRAME ASSEMBLY - FRONT WALL

STEP 3

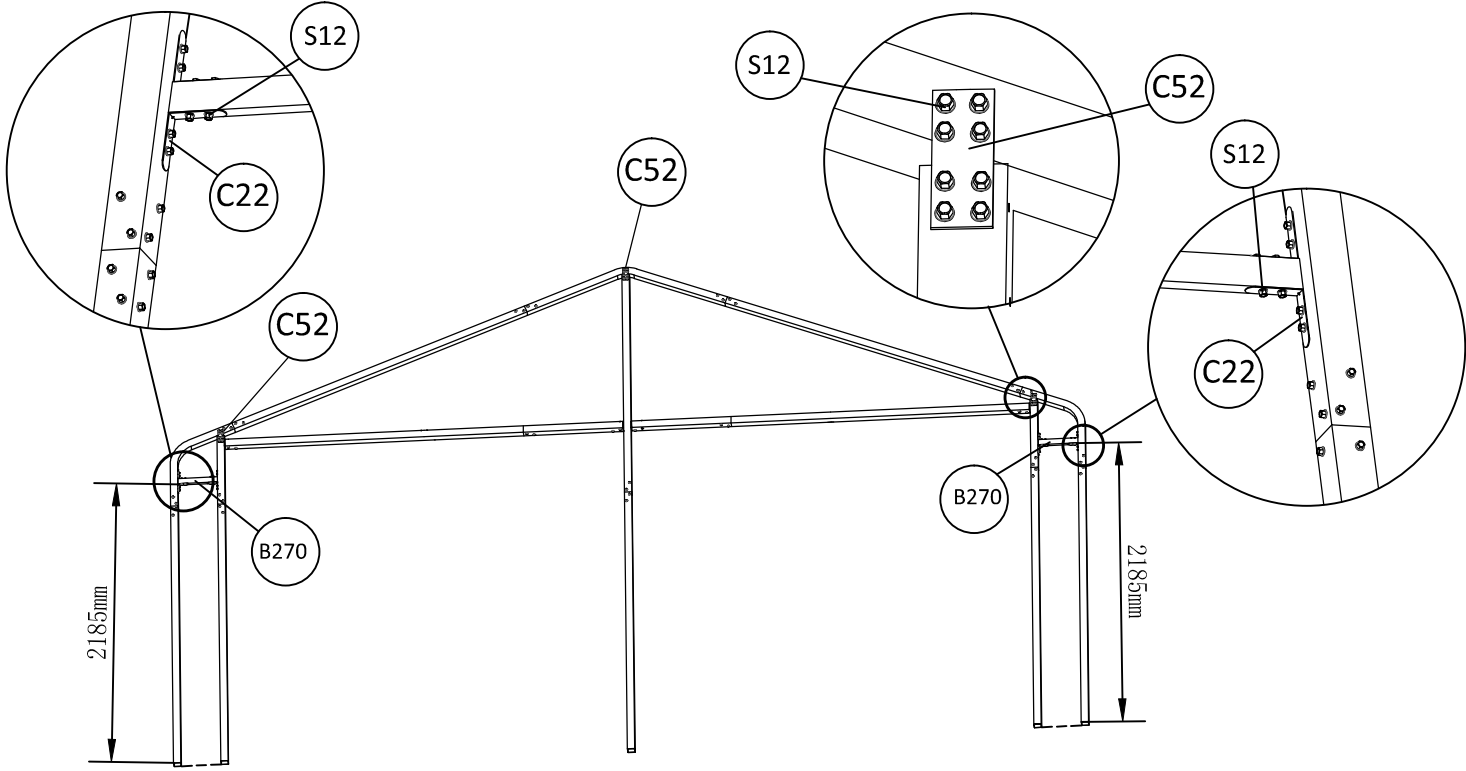
	B270	2		C22	8		C52	3		S12	56
---	------	---	---	-----	---	---	-----	---	---	-----	----





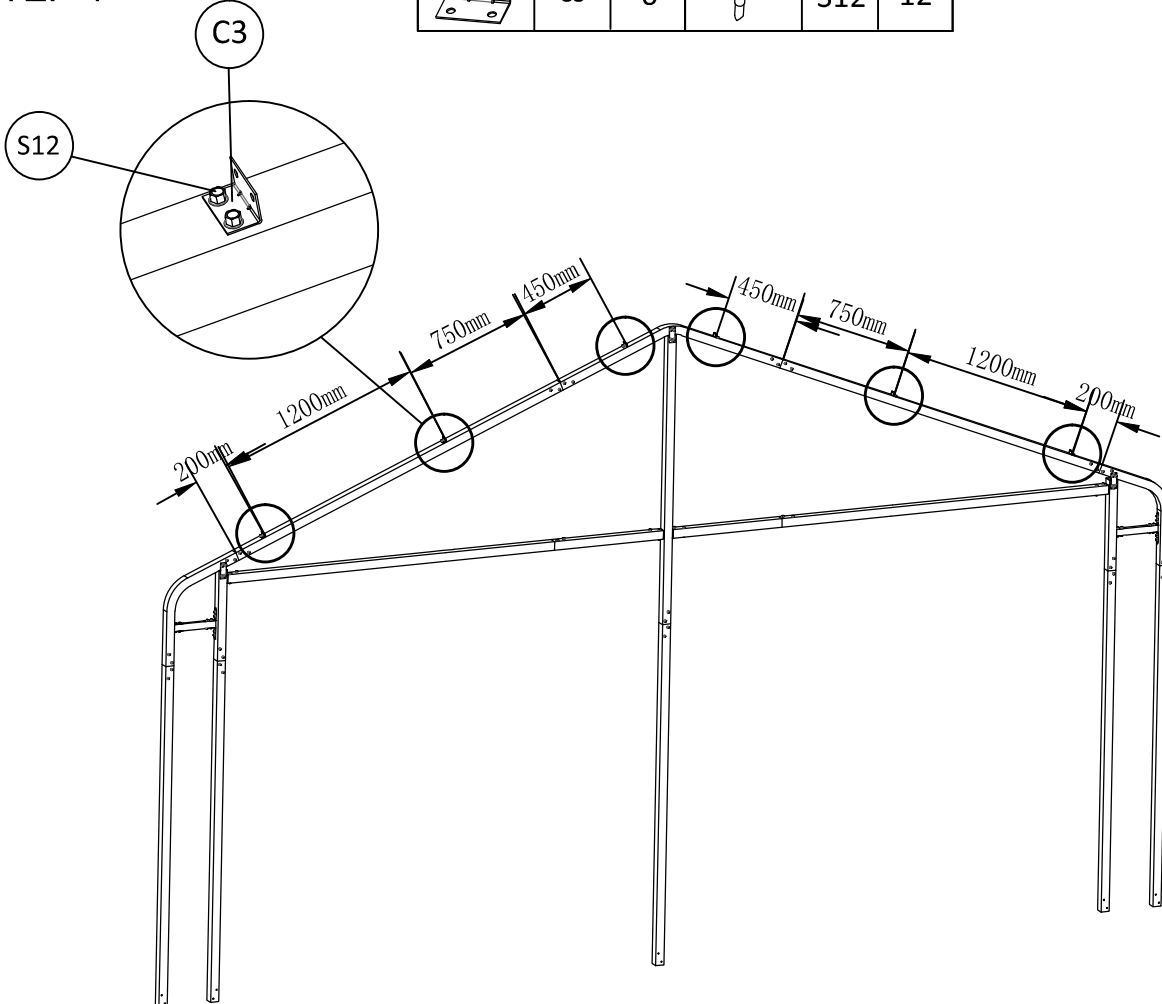

STEP 4

	C3	6		S12	12
---	----	---	---	-----	----



# FRAME ASSEMBLY - MIDDLE PART

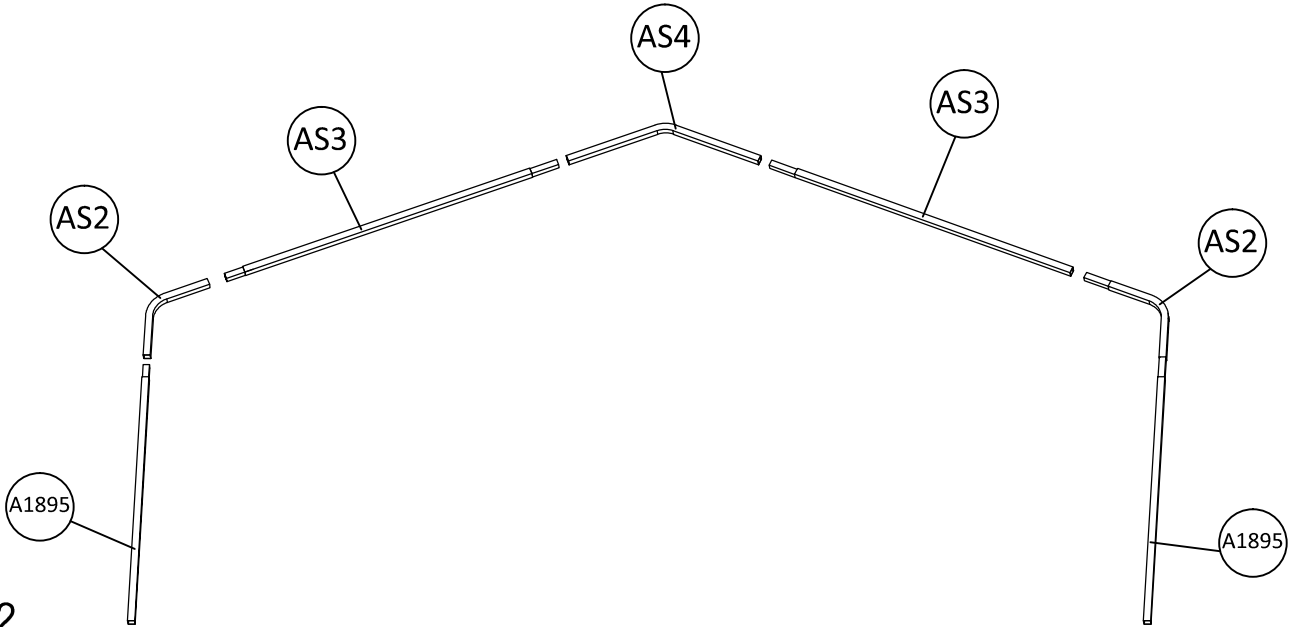

STEP 1

	A1895	2		AS2	2		AS3	2		AS4	1
	S12	24									

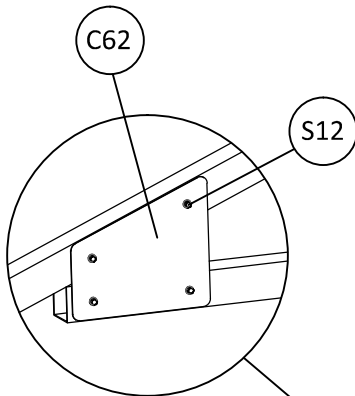

STEP 2



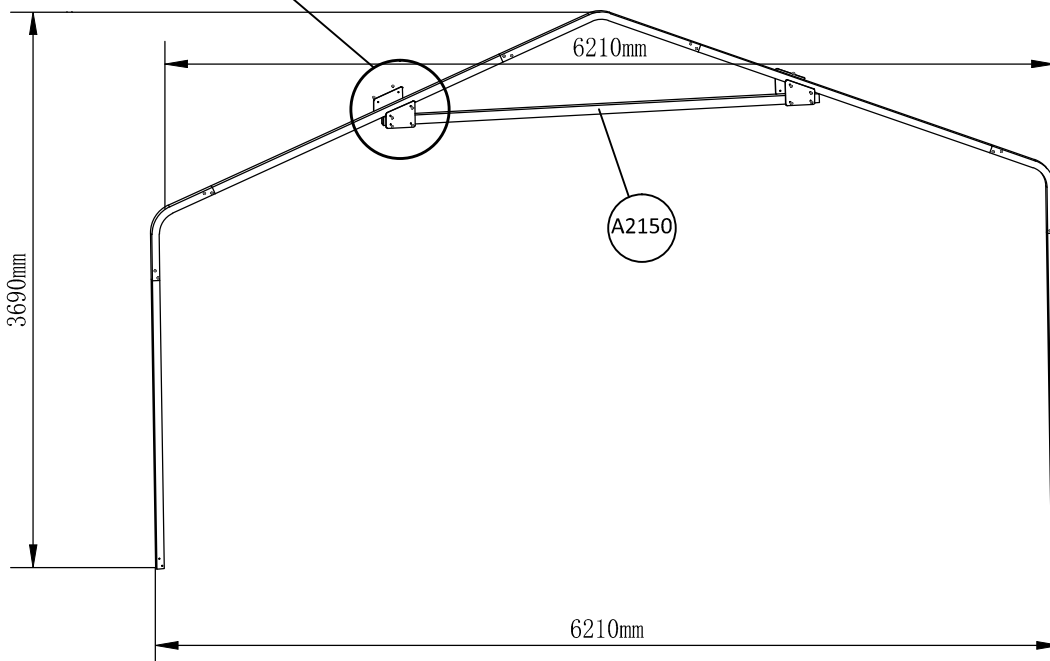

	C62	4		S12	16		A2150	1
---	-----	---	---	-----	----	---	-------	---



# FRAME ASSEMBLY - MIDDLE PART





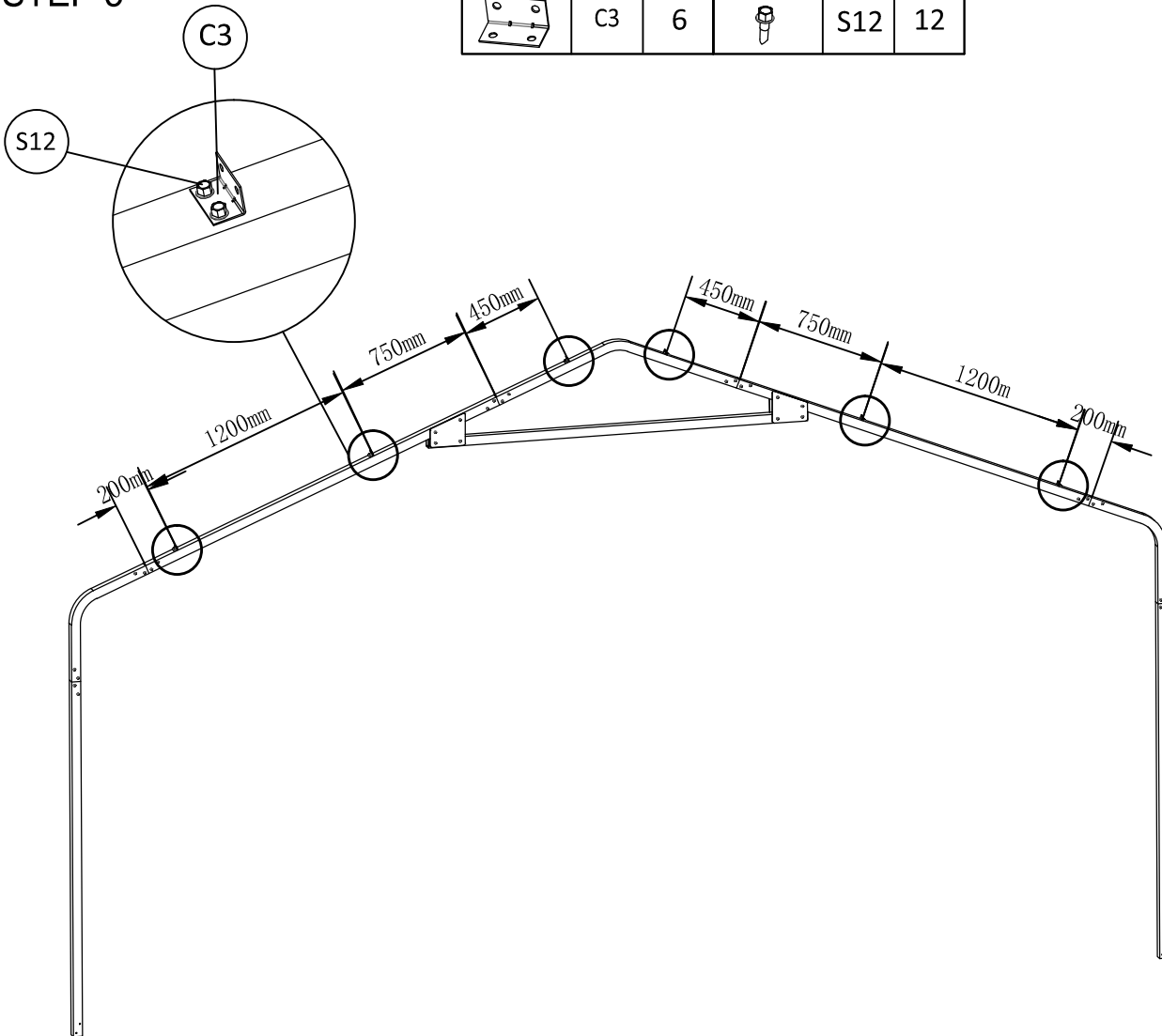

STEP 3

	C3	6		S12	12
---	----	---	---	-----	----



× 3

# FRAME ASSEMBLY - BASE

	A1B	2		A2A	2		A1A	2		A3A	2
	A2B	1		A3B	2		S12	40			

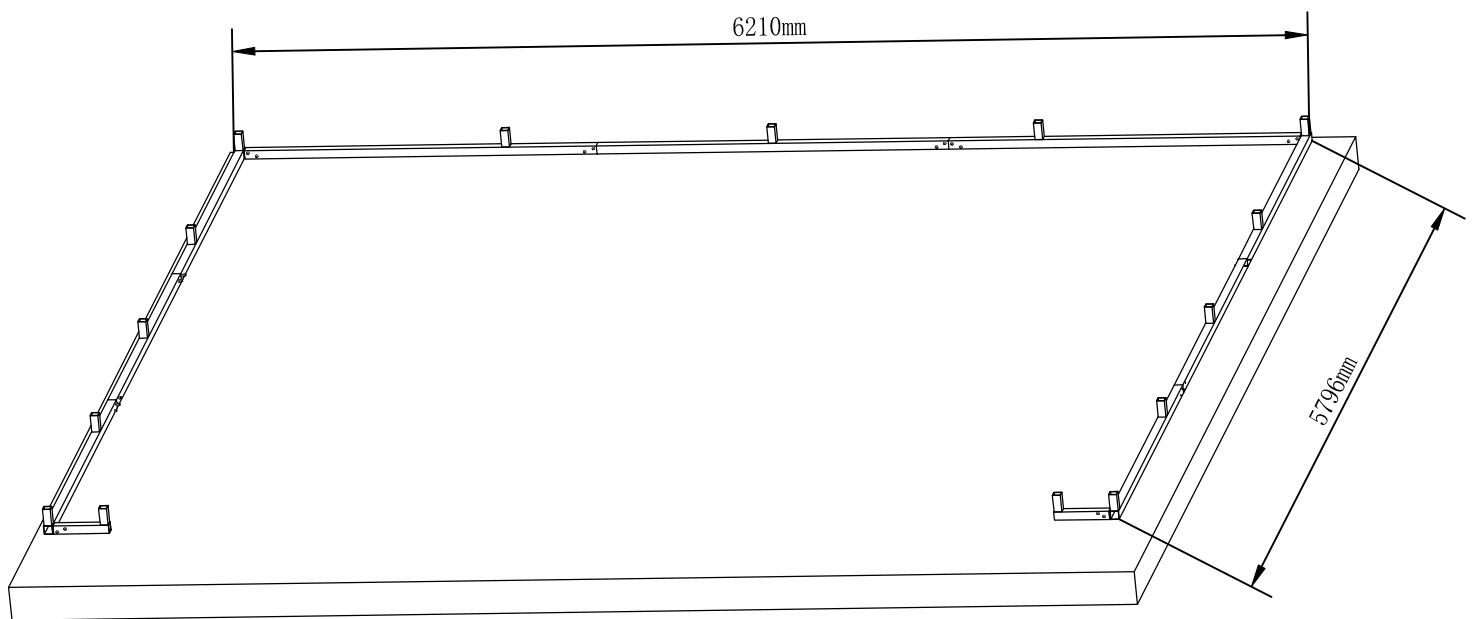
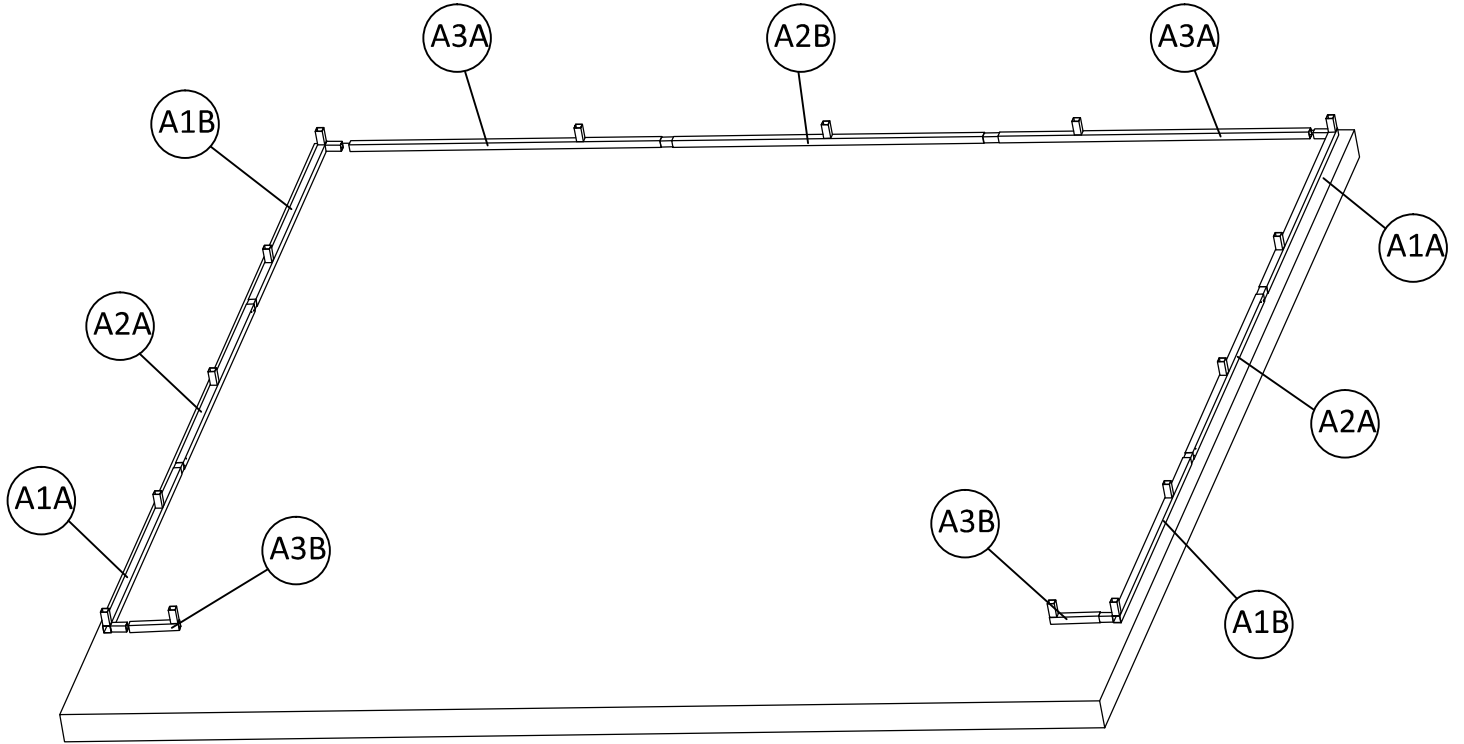

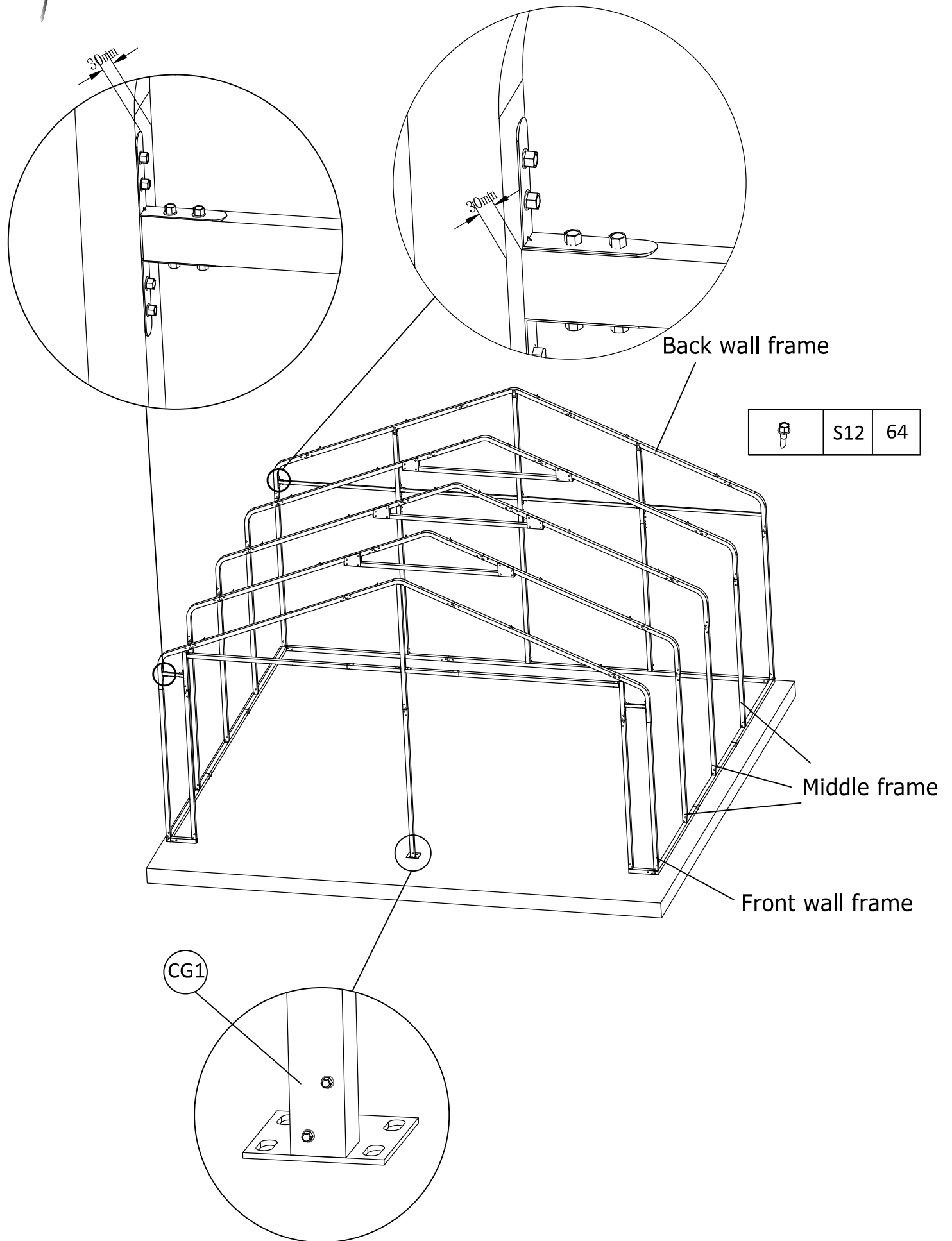

# FRAME ASSEMBLY





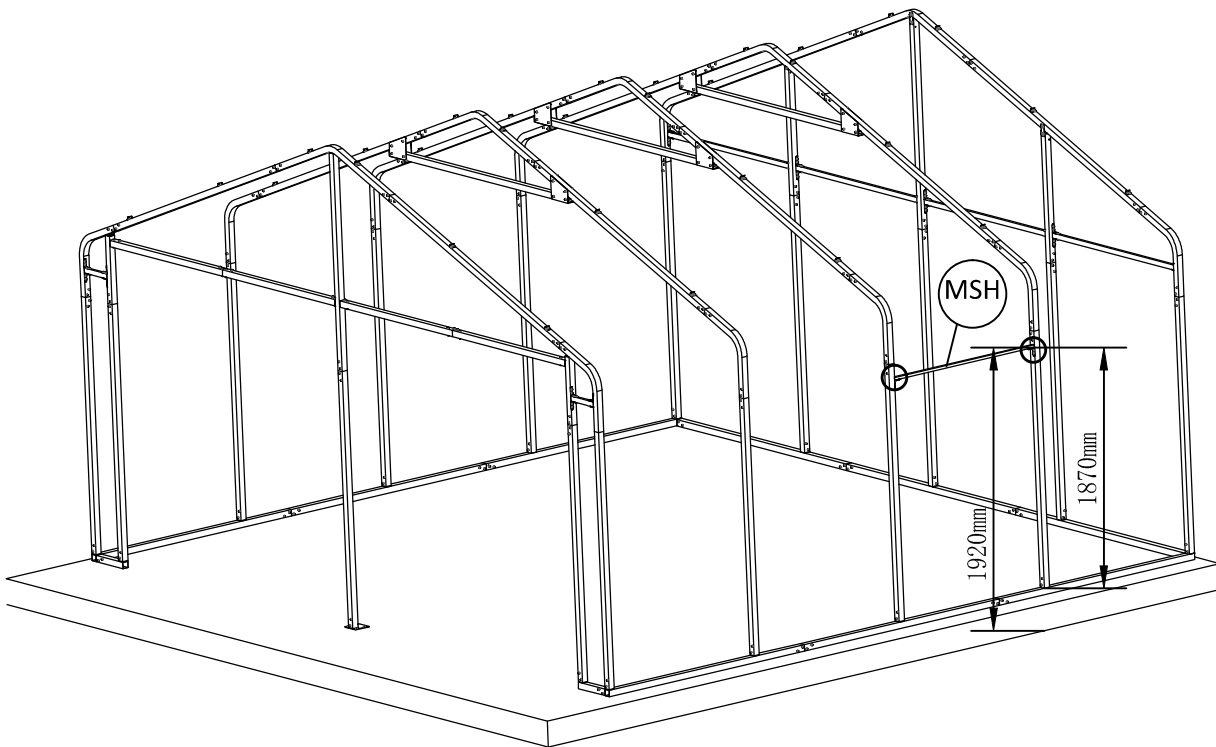
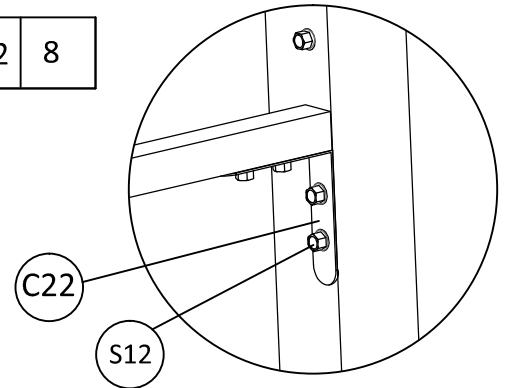

If you want to install the side door on the right, please follow the steps on page 18- 28.

If you want to install the side door on the left ,please follow the steps on page 42- 52.

	MSH	1		C22	2		S12	8
---	-----	---	---	-----	---	---	-----	---



# FRAME ASSEMBLY - BEAM PART

	B1467	12		B1432	12		S12	60		S13	48
---	-------	----	---	-------	----	---	-----	----	---	-----	----

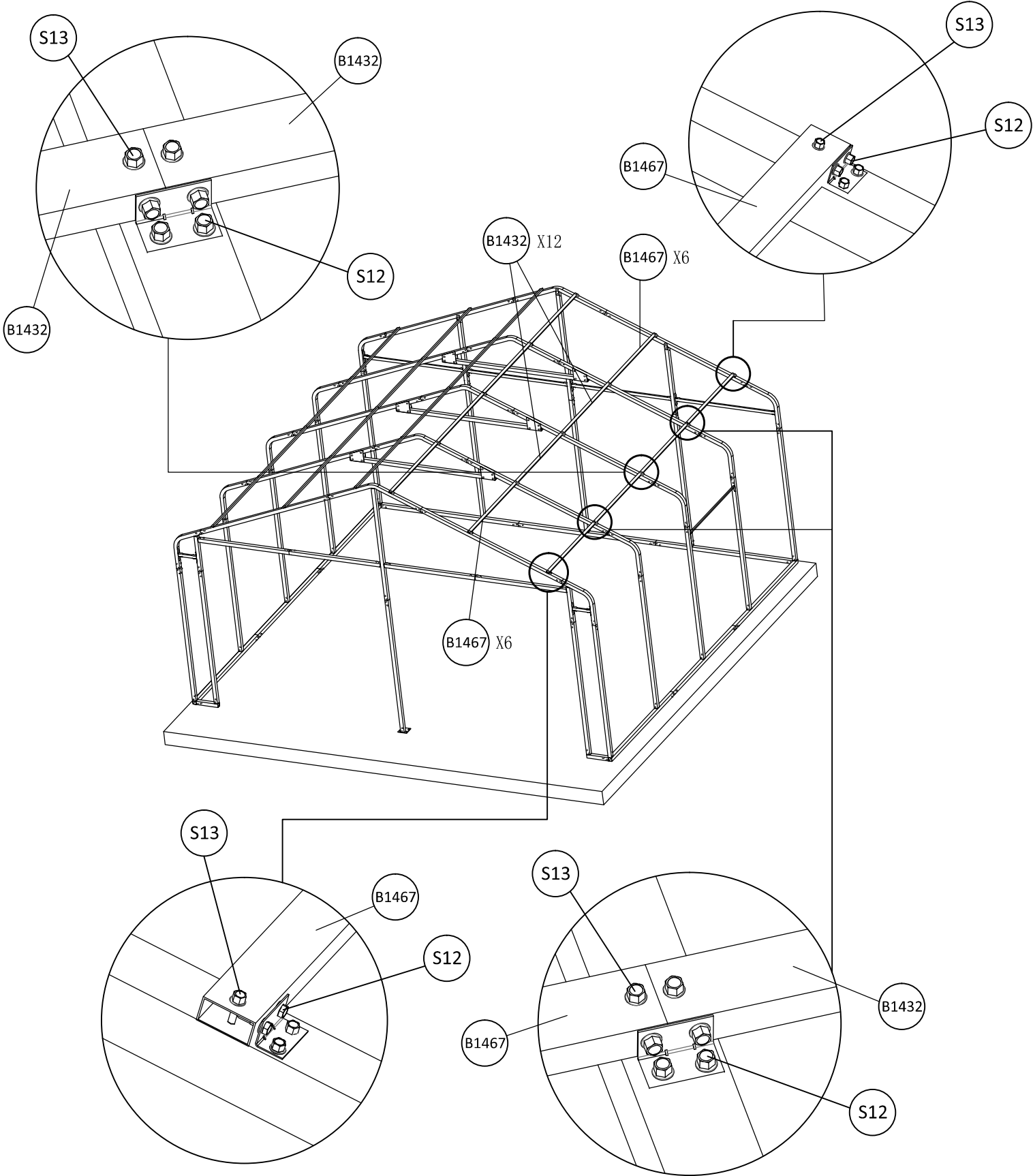



# FRAME ASSEMBLY

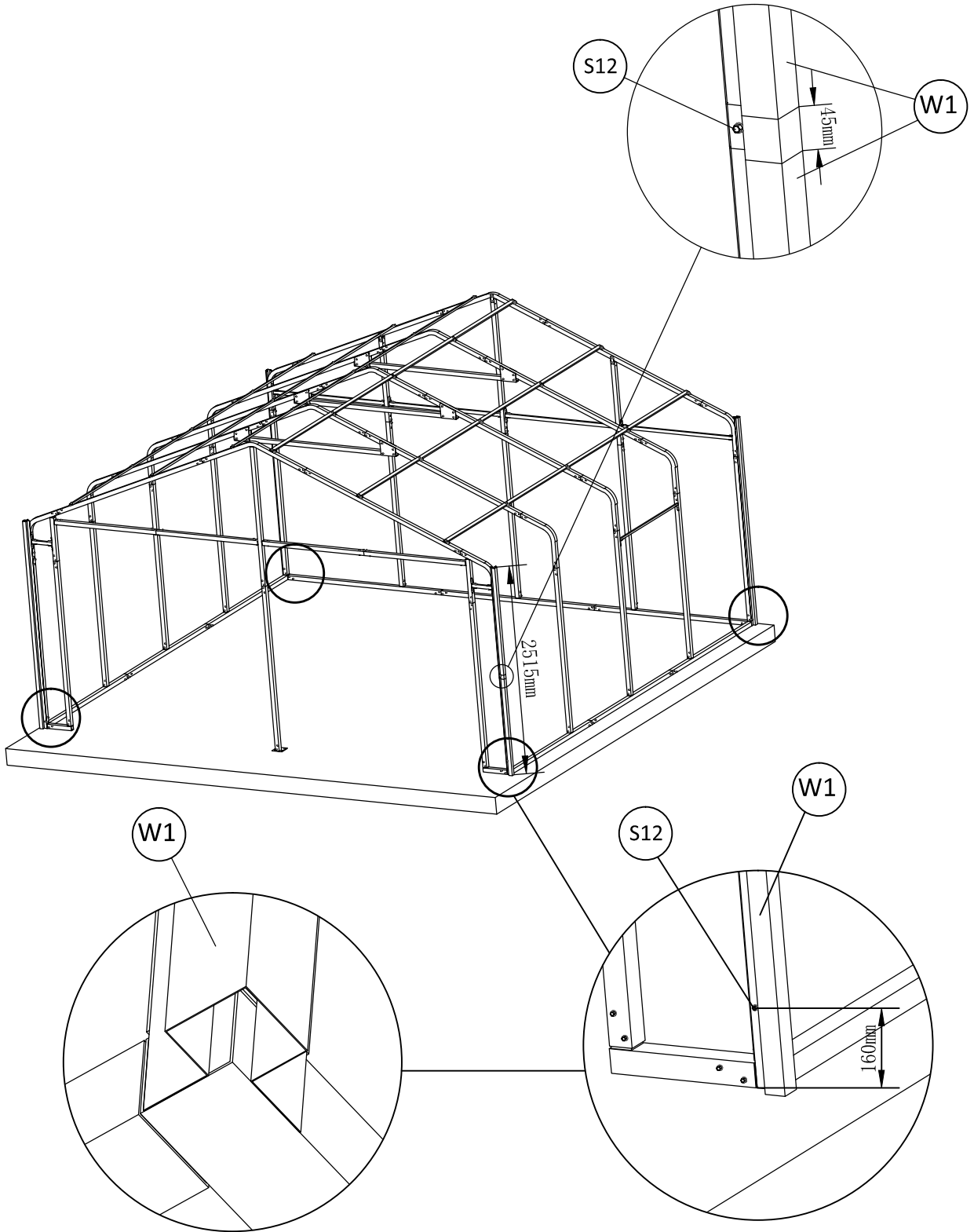

	W1	8		S12	16
---	----	---	---	-----	----



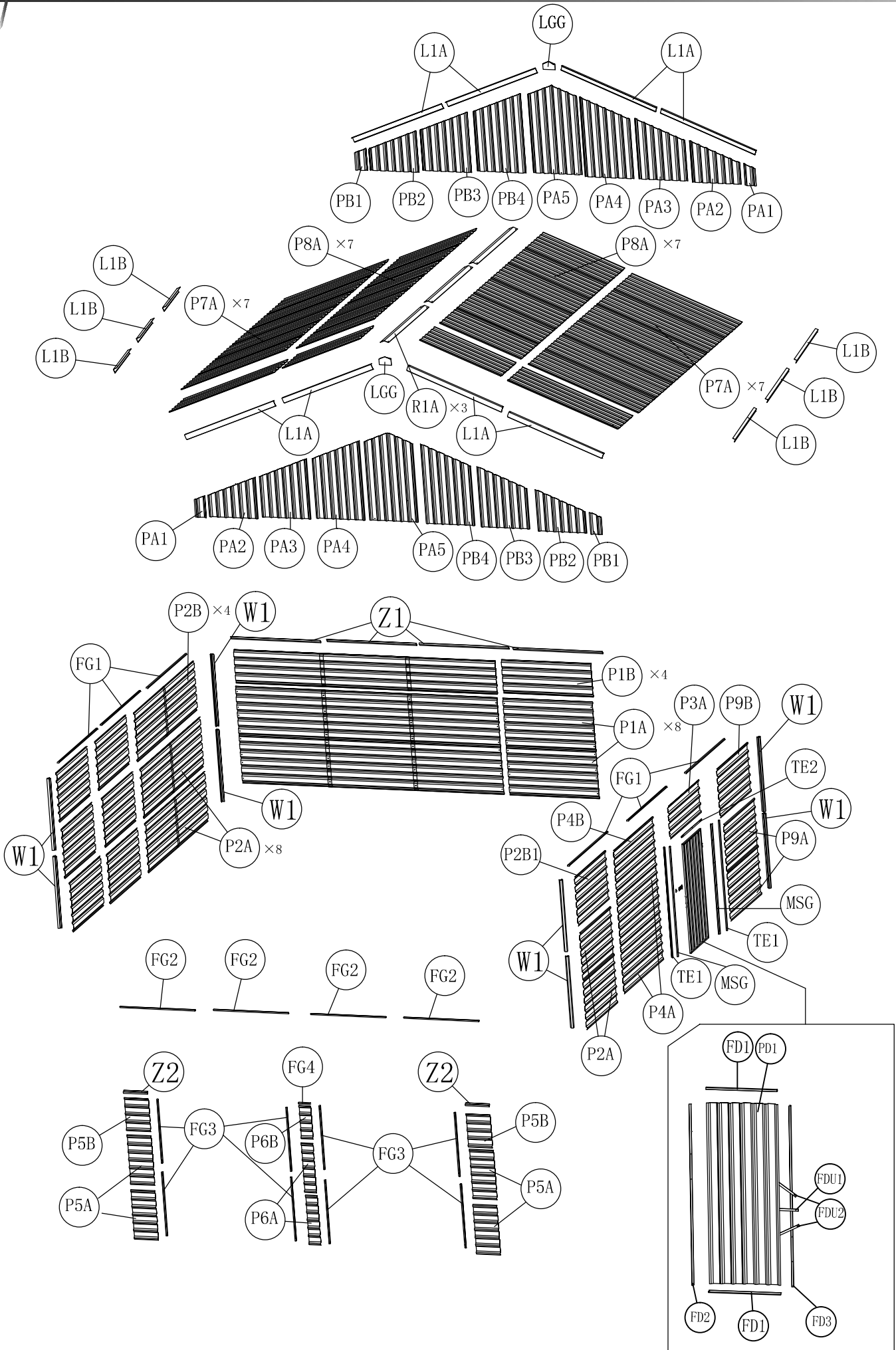

# PANEL ASSEMBLY



# PANEL ASSEMBLY - BACK WALL

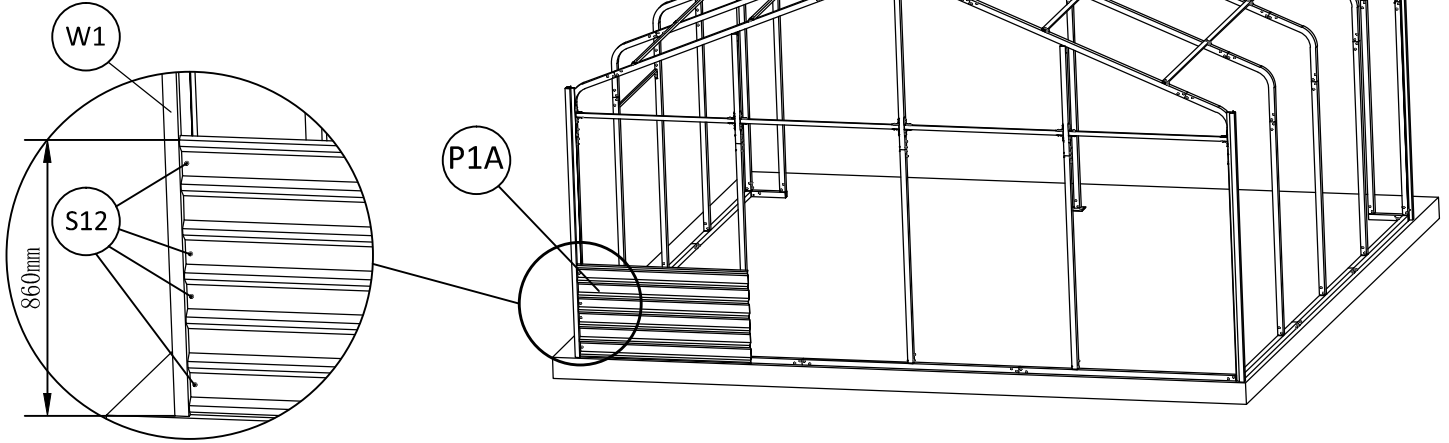

	P1A	1		S12	4
---	-----	---	---	-----	---



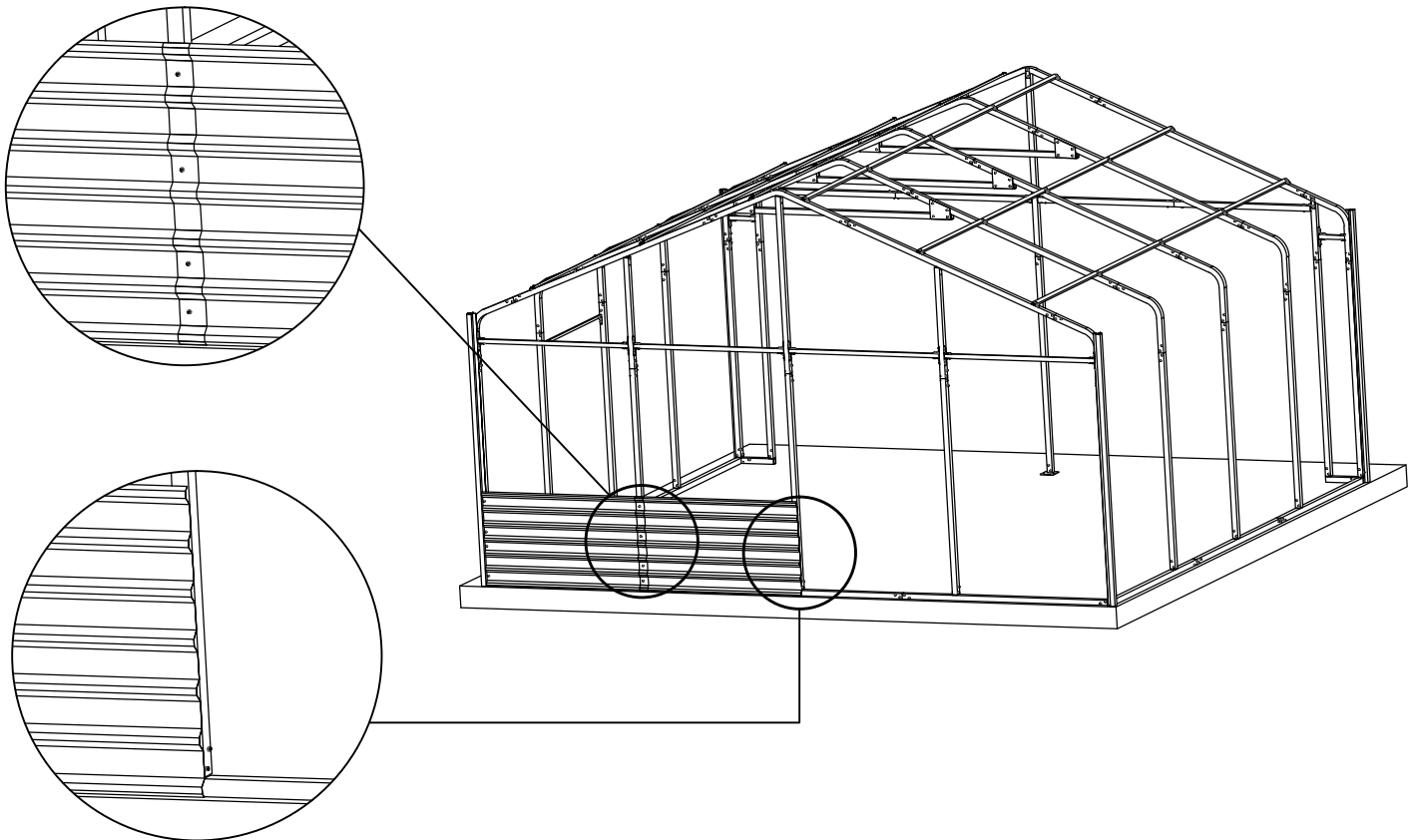

	P1A	1		S12	4
--	-----	---	---	-----	---

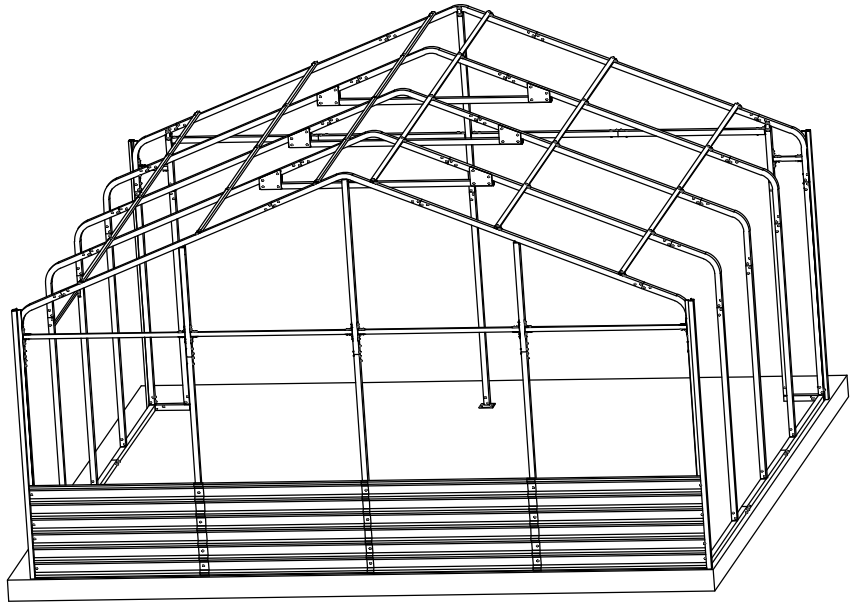

# PANEL ASSEMBLY - BACK WALL

	P1A	2		S12	12
---	-----	---	---	-----	----



	P1A	4		S12	20
--	-----	---	---	-----	----

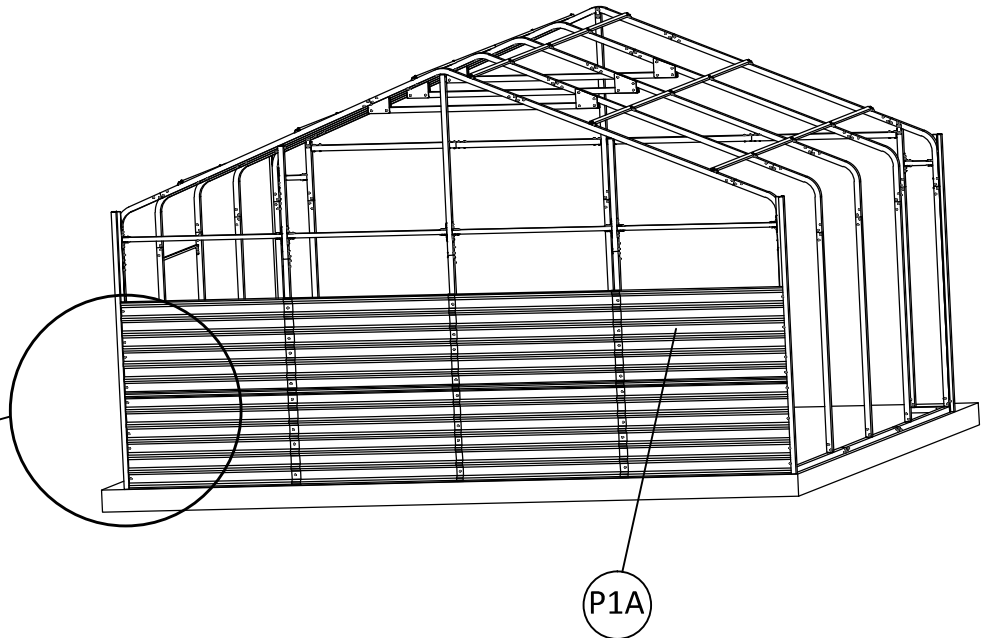
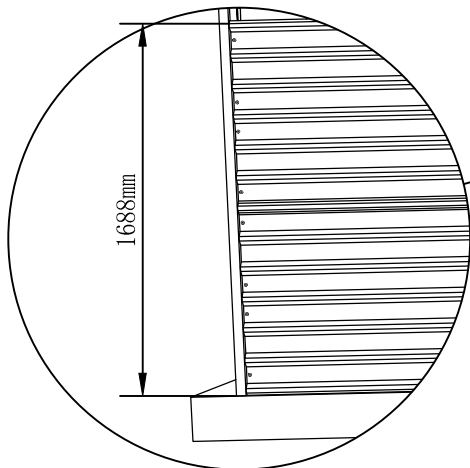
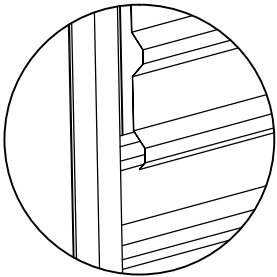

When two panels overlap, make sure upper panel covers the lower panel.

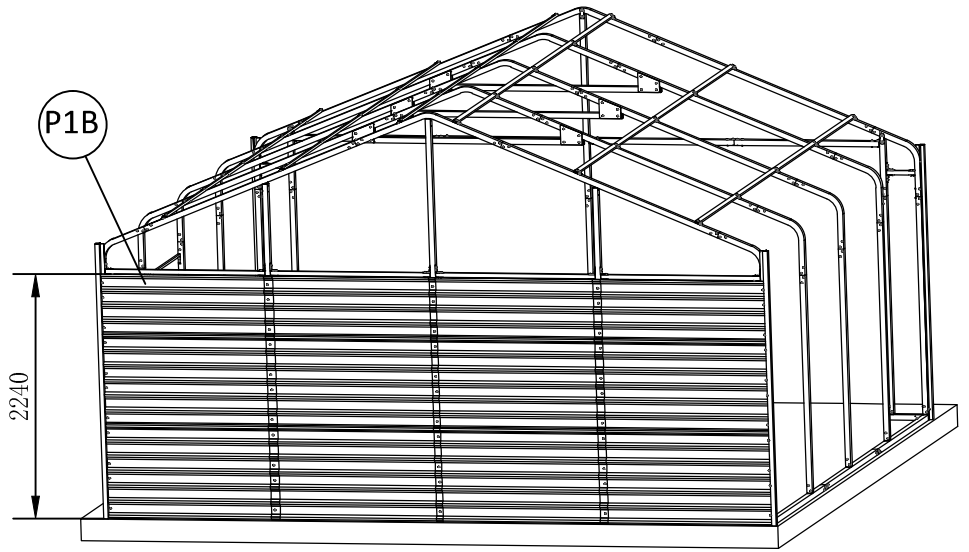
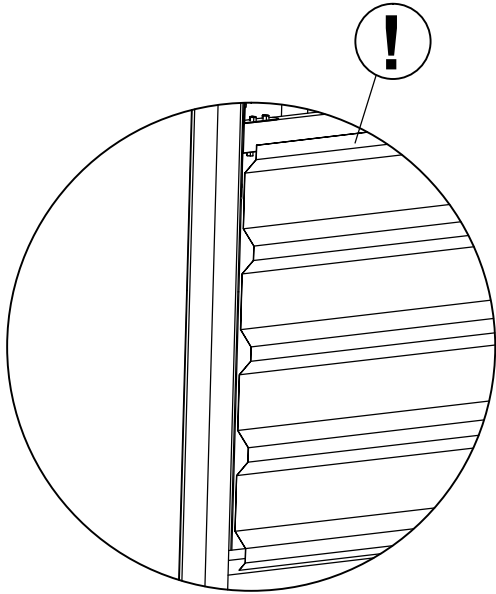

# PANEL ASSEMBLY - BACK WALL

	P1B	4		S12	20
---	-----	---	---	-----	----



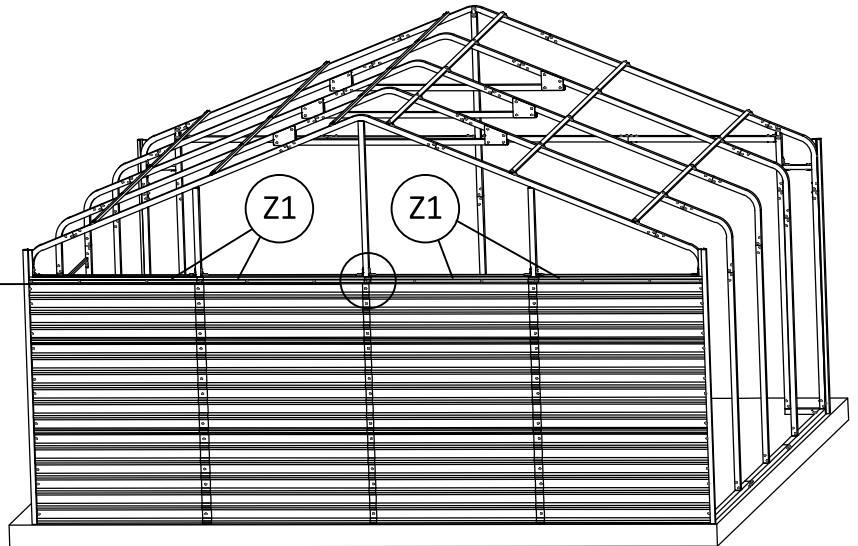
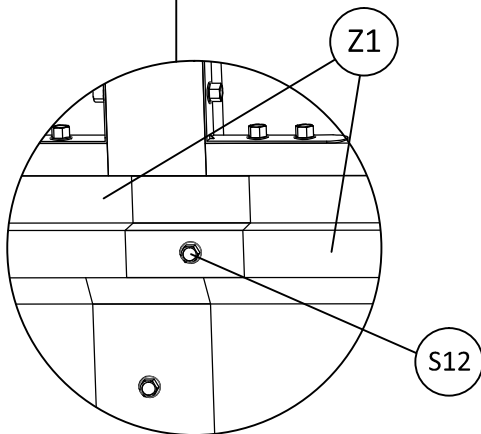
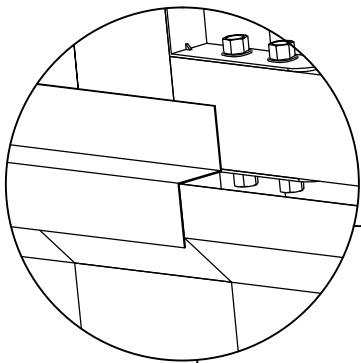

	Z1	4		S12	13
---	----	---	---	-----	----



# PANEL ASSEMBLY - LEFT WALL

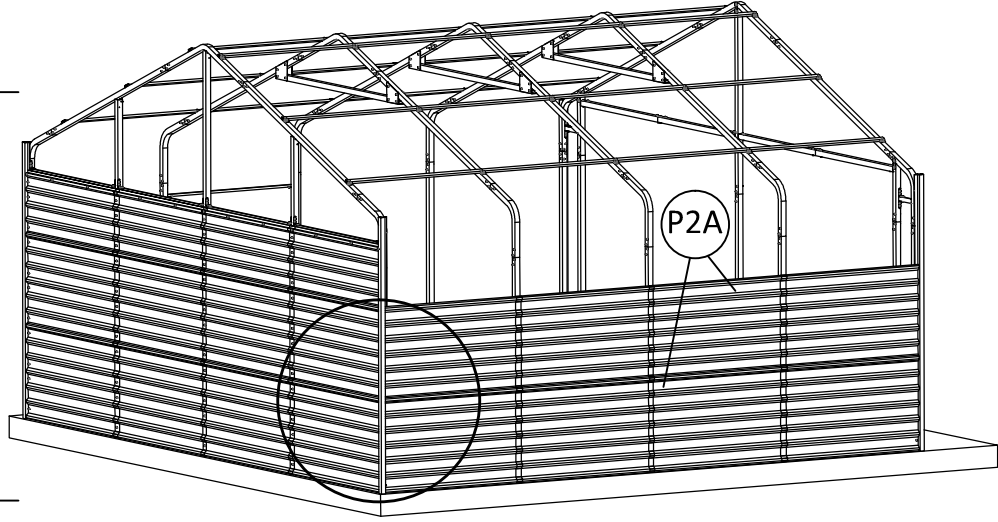
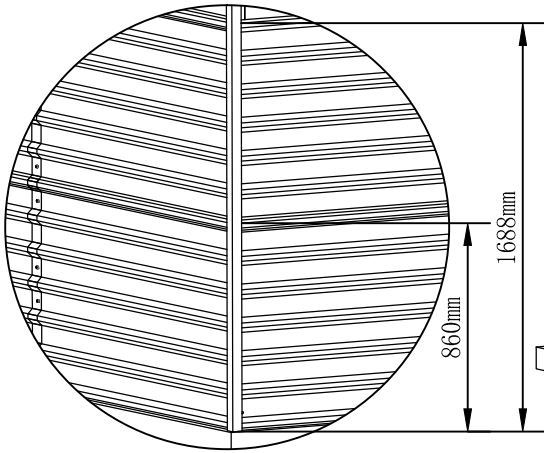

	P2A	8		S12	40
---	-----	---	---	-----	----



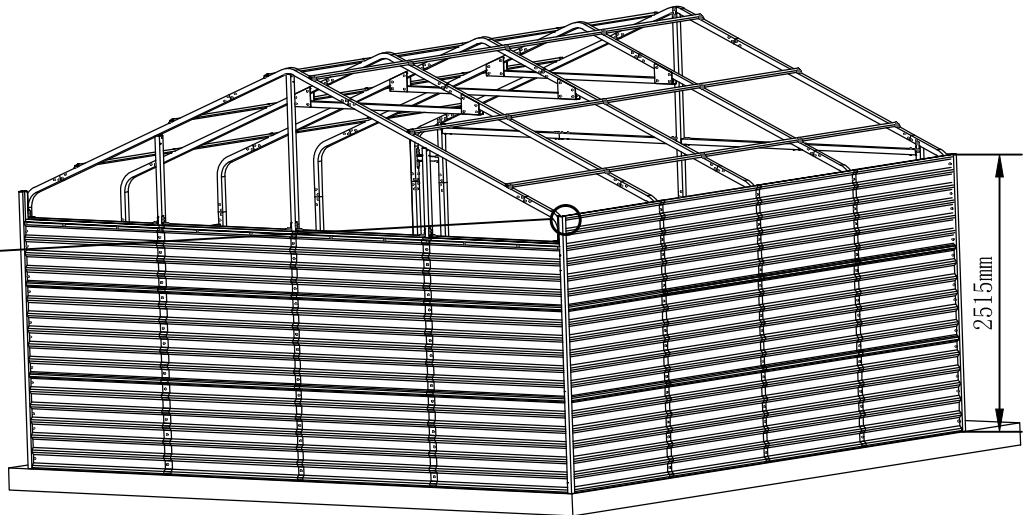
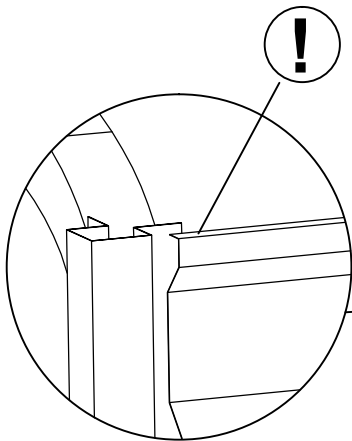



	P2B	4		S12	20
---	-----	---	---	-----	----

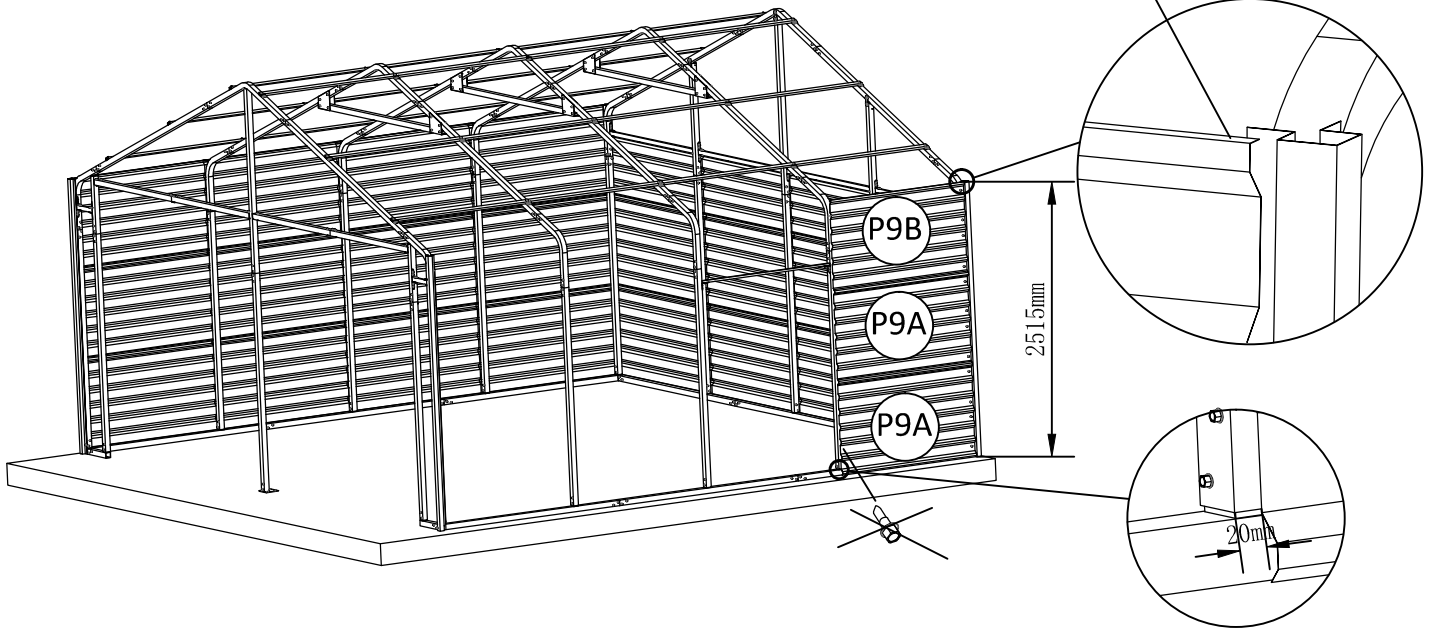

# PANEL ASSEMBLY - RIGHT WALL

	P9A	2		P9B	1		S12	12
---	-----	---	---	-----	---	---	-----	----





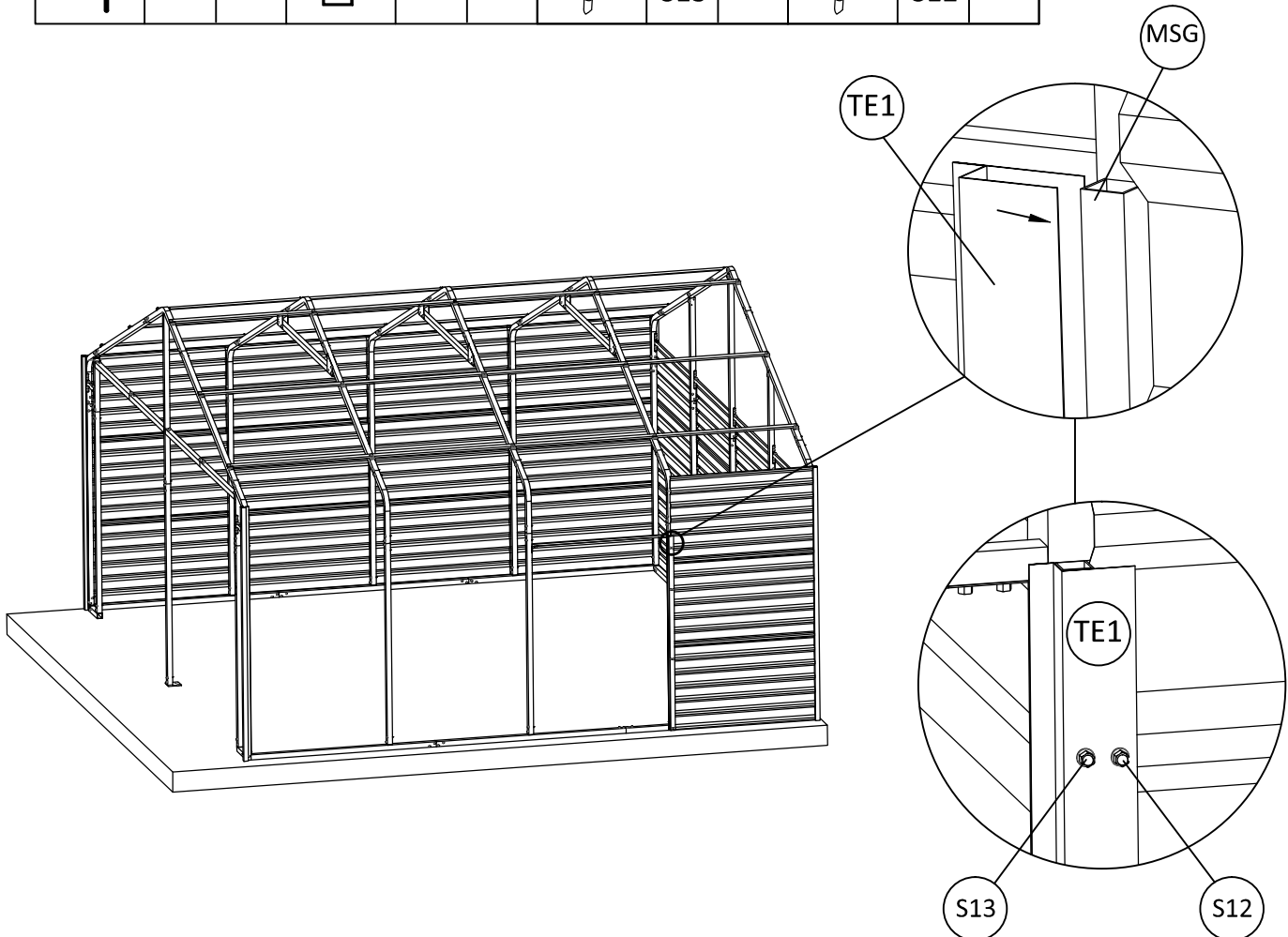

4	TE1	1		MSG	1		S13	5		S12	5
---	-----	---	---	-----	---	---	-----	---	---	-----	---

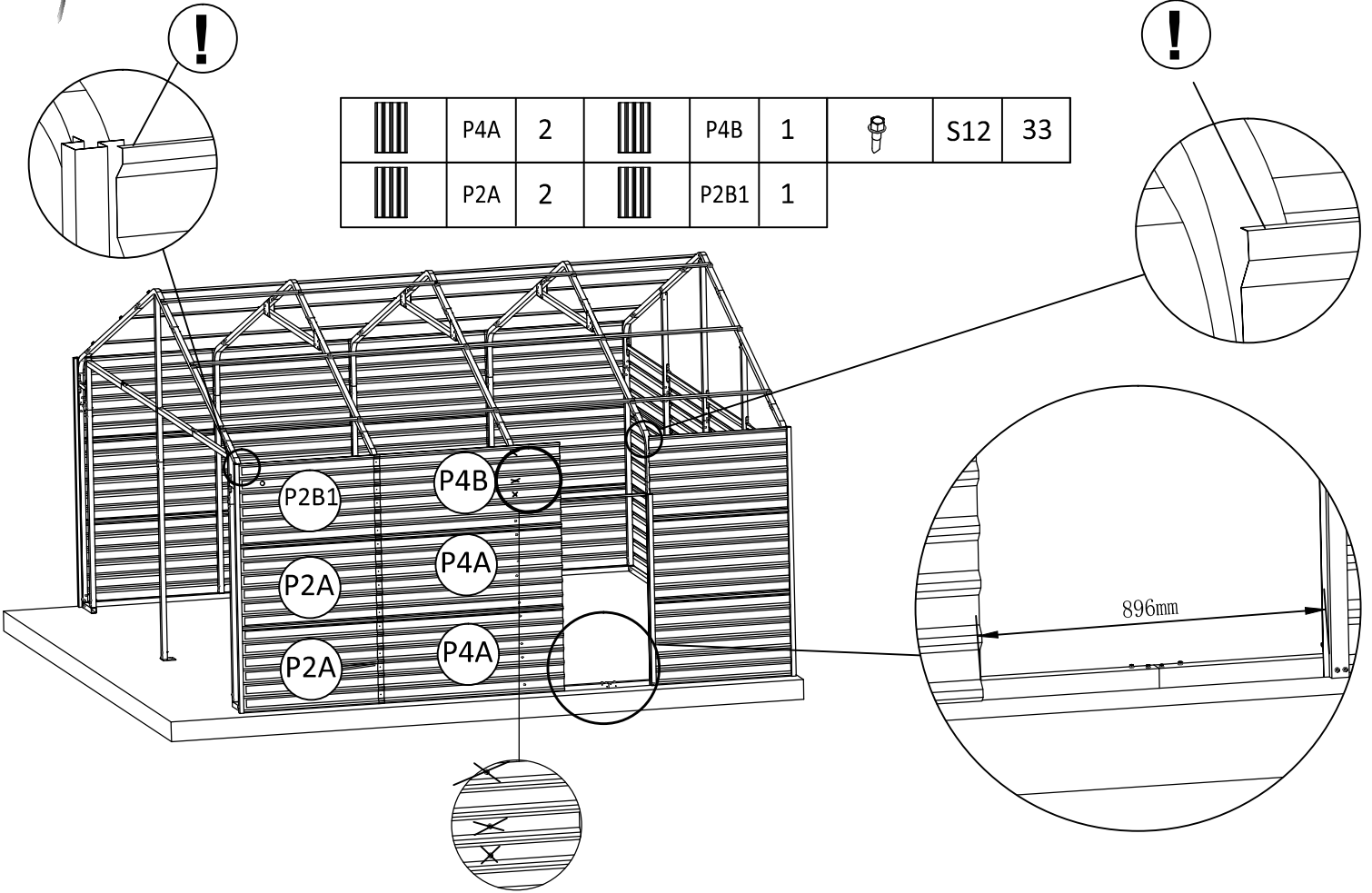

# PANEL ASSEMBLY - RIGHT WALL

	P4A	2		P4B	1		S12	33
	P2A	2		P2B1	1			





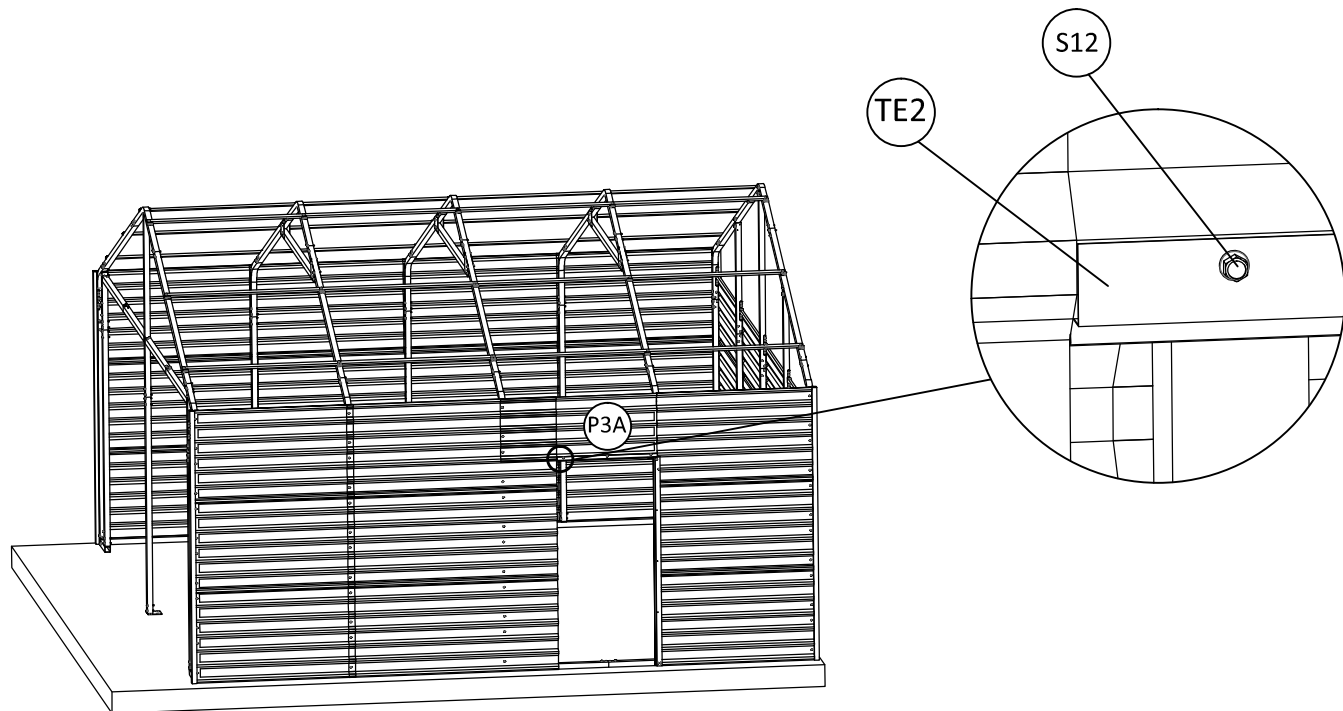

	P3A	1		S12	9		TE2	1
---	-----	---	---	-----	---	---	-----	---







# PANEL ASSEMBLY - RIGHT WALL

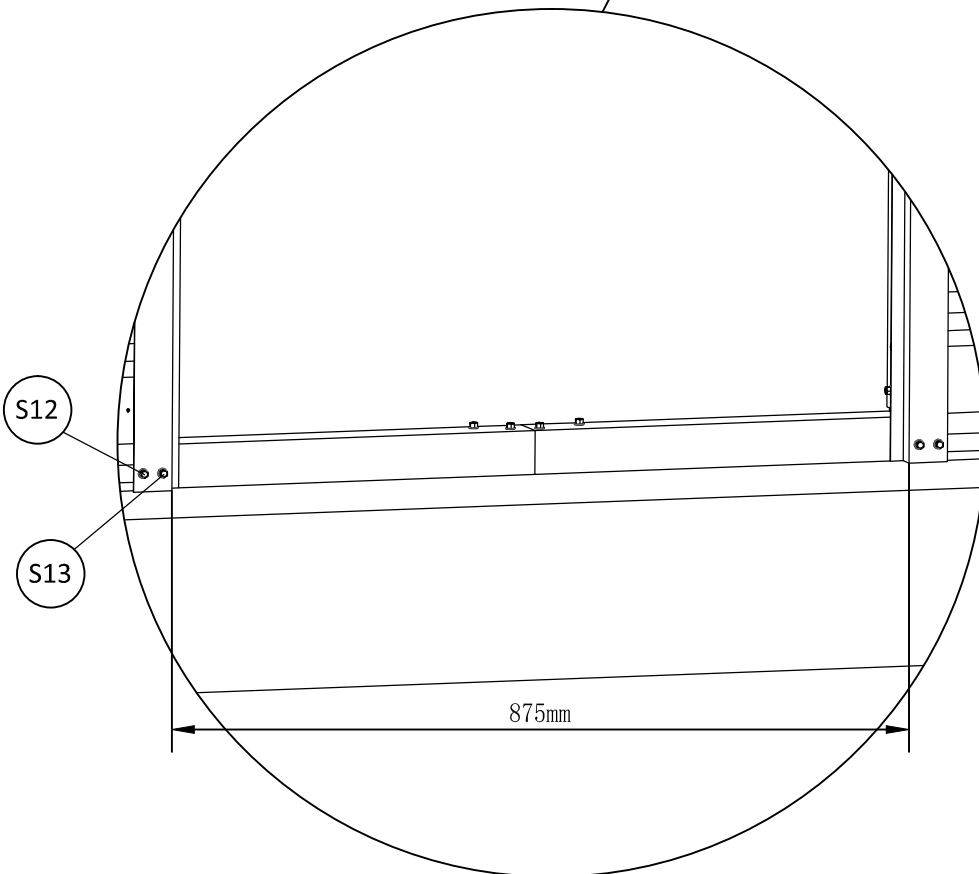
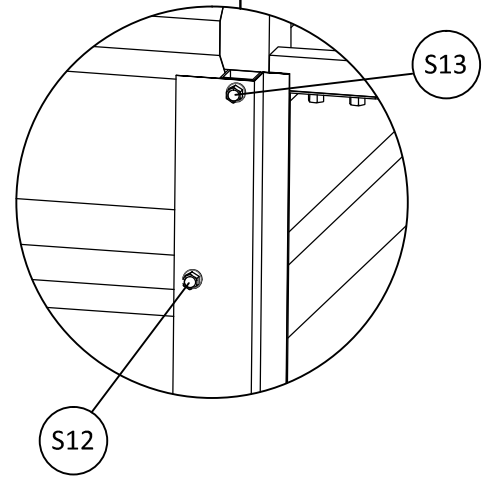
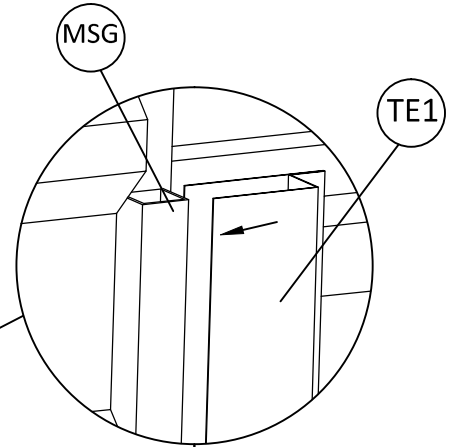
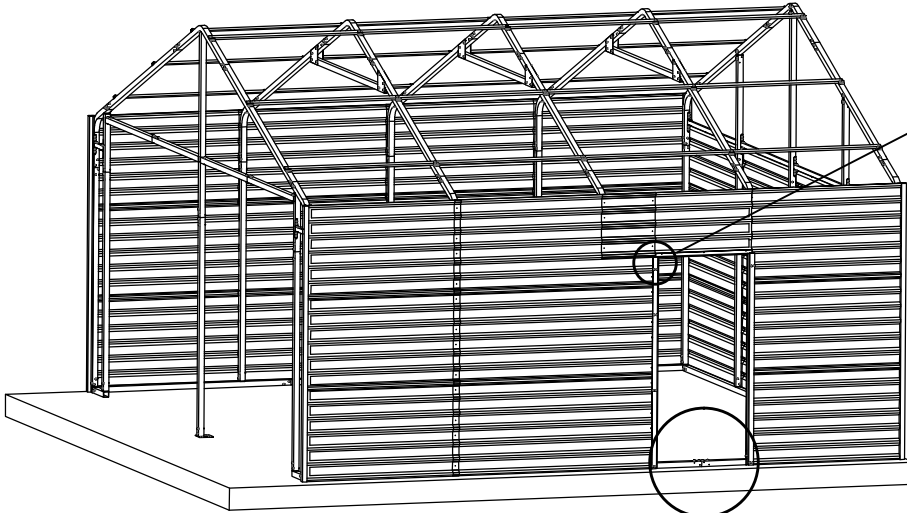





	TE1	1		S12	8		S13	2
	MSG	1						

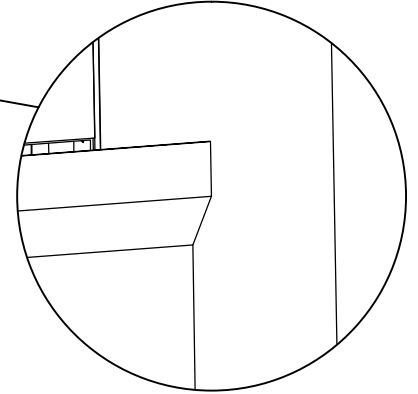
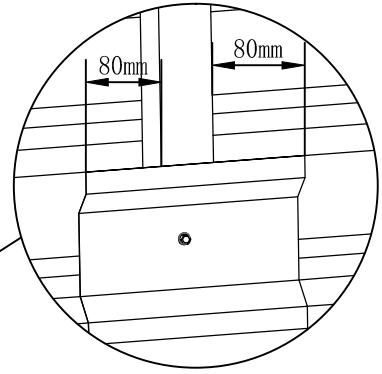
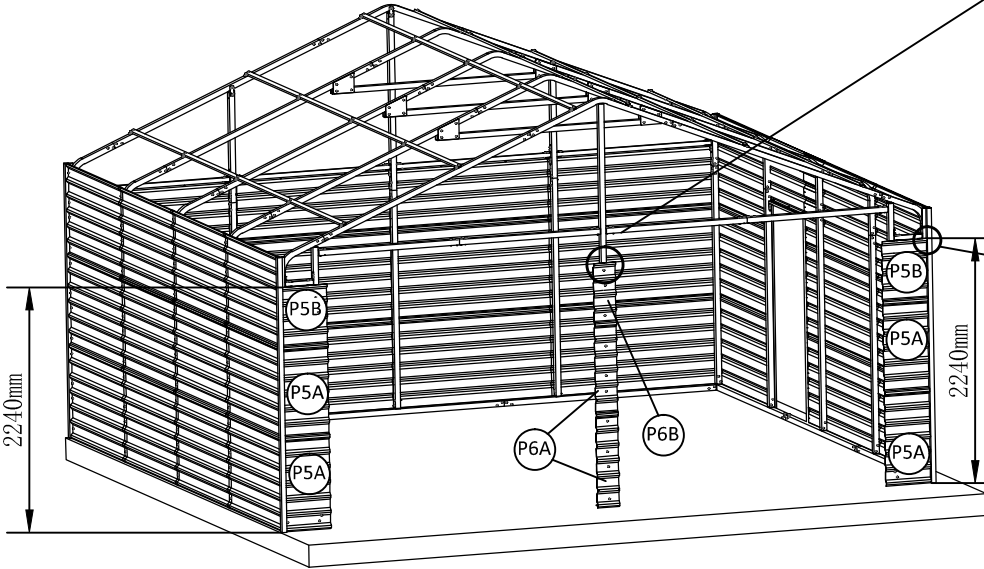

# PANEL ASSEMBLY - FRONT WALL

	P5A	4		P5B	2		S12	51
	P6A	2		P6B	1			



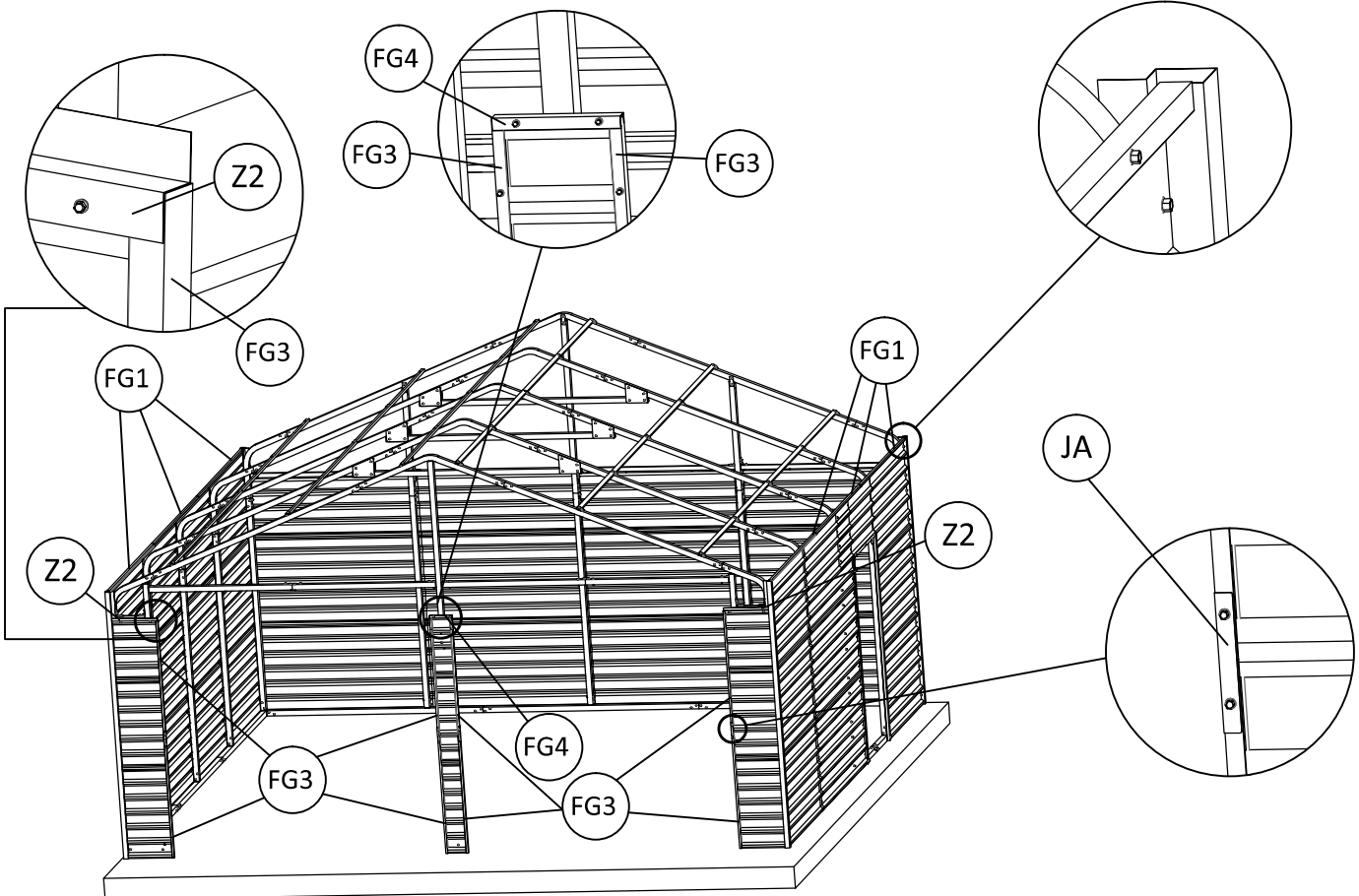

	FG1	6		FG3	8		FG4	1		Z2	2		S12	86
	JA	8												



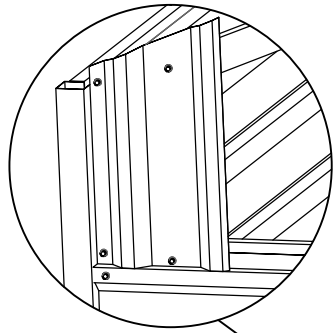







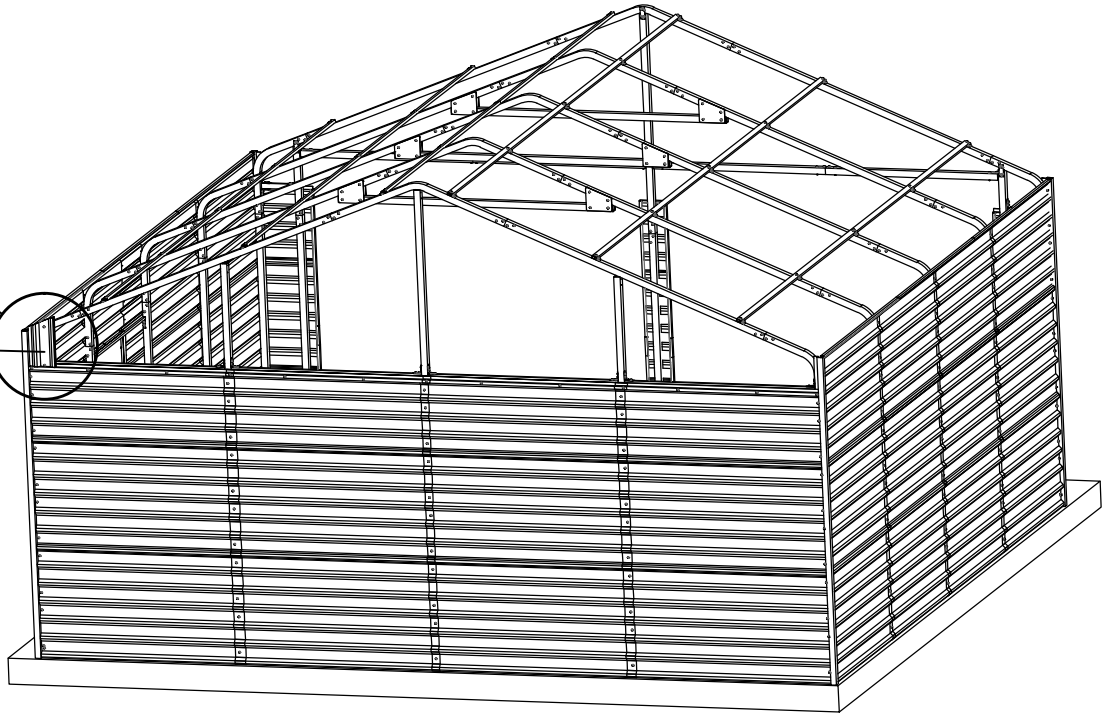

# PANEL ASSEMBLY



	PA1	1		S12	4
---	-----	---	---	-----	---







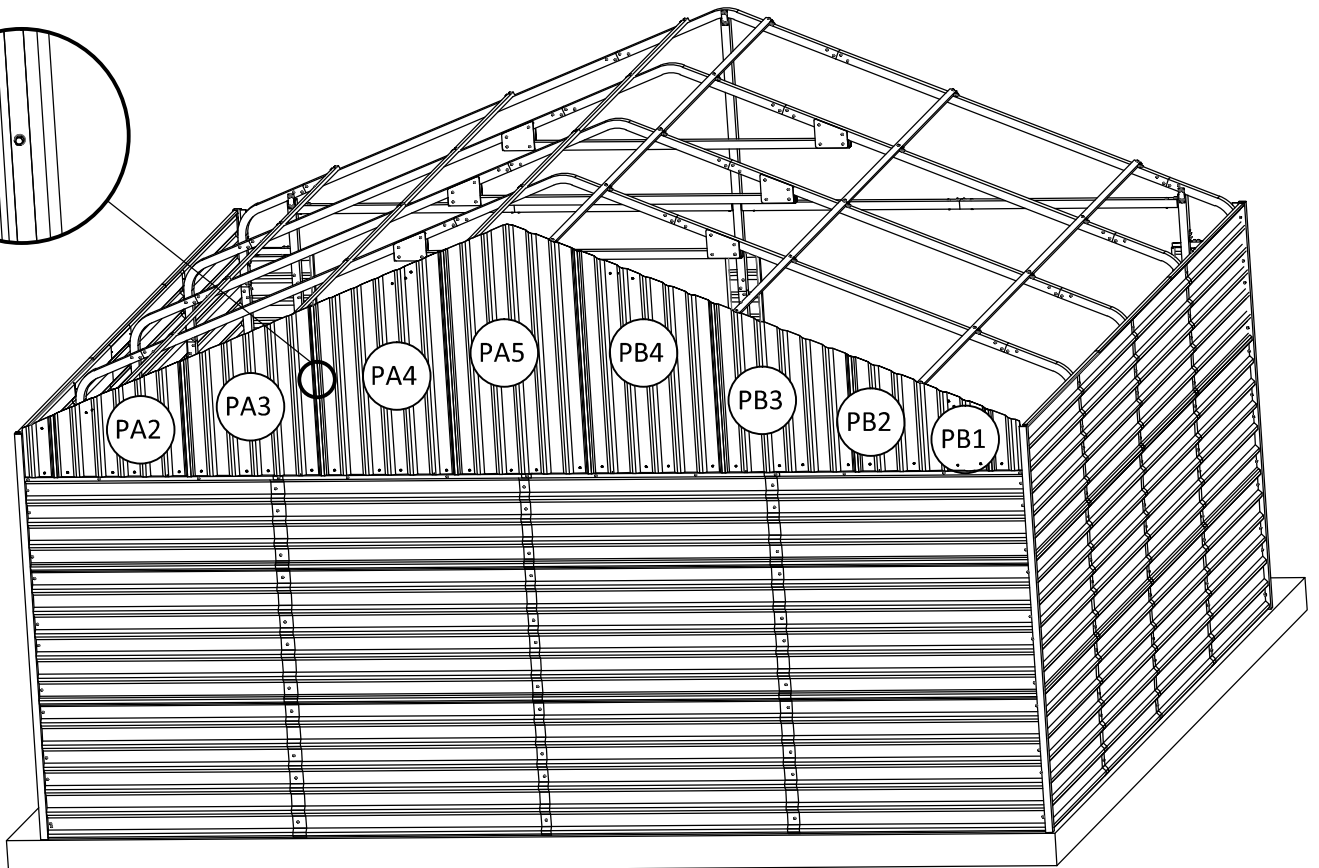
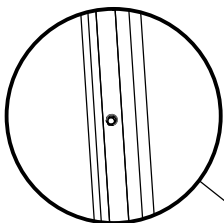



PA1







	PA2	1		PA3	1		PA4	1		PA5	1		PB4	1
	PB3	1		PB2	1		PB1	1		S12	72			

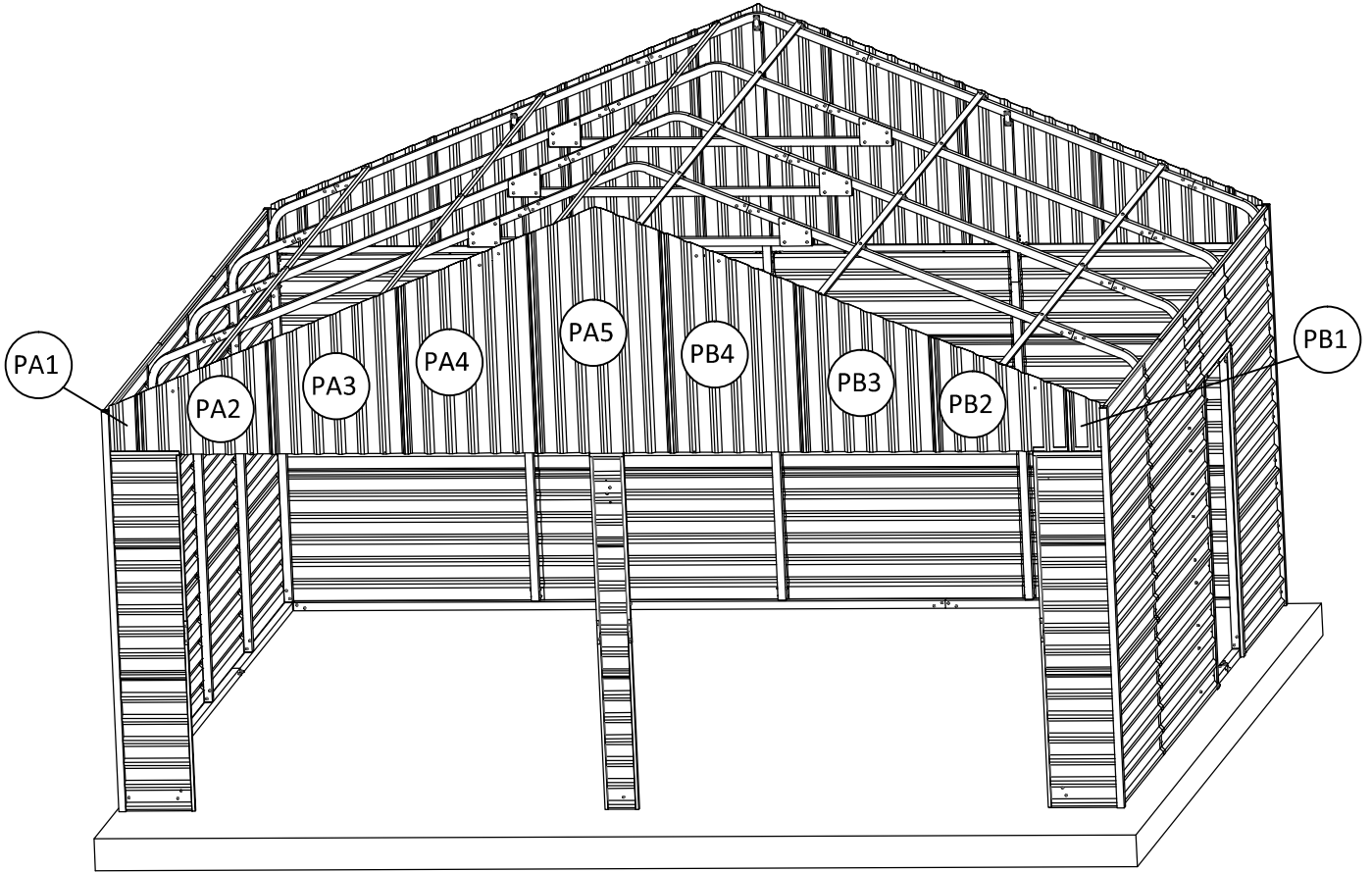

# PANEL ASSEMBLY - FRONT WALL



	PA2	1		PA3	1		PA4	1		PA5	1		PB4	1
	PB3	1		PB2	1		PB1	1		PA1	1		S12	72

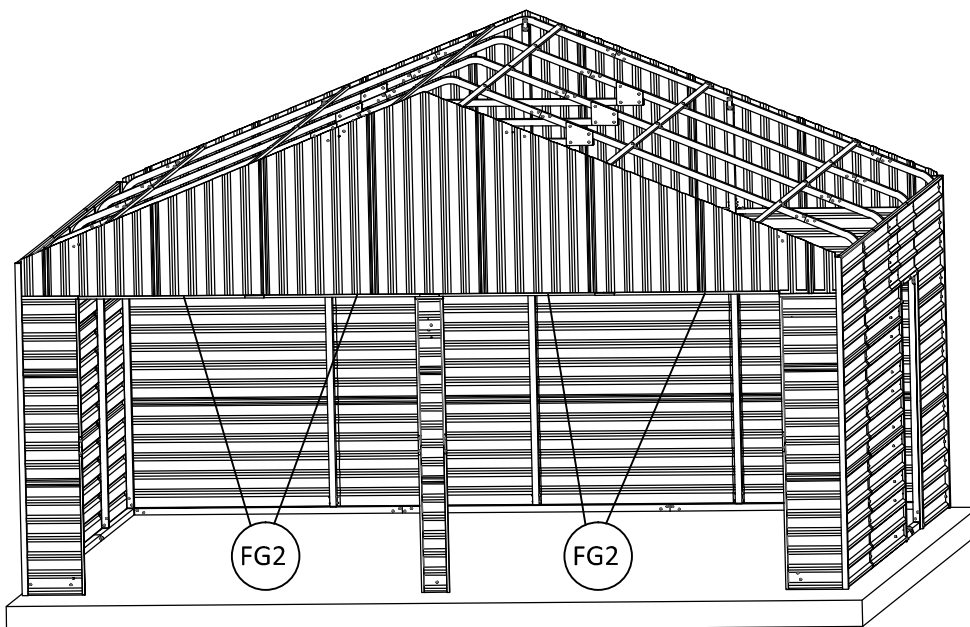

	FG2	4		JA	3		S12	28
---	-----	---	---	----	---	---	-----	----



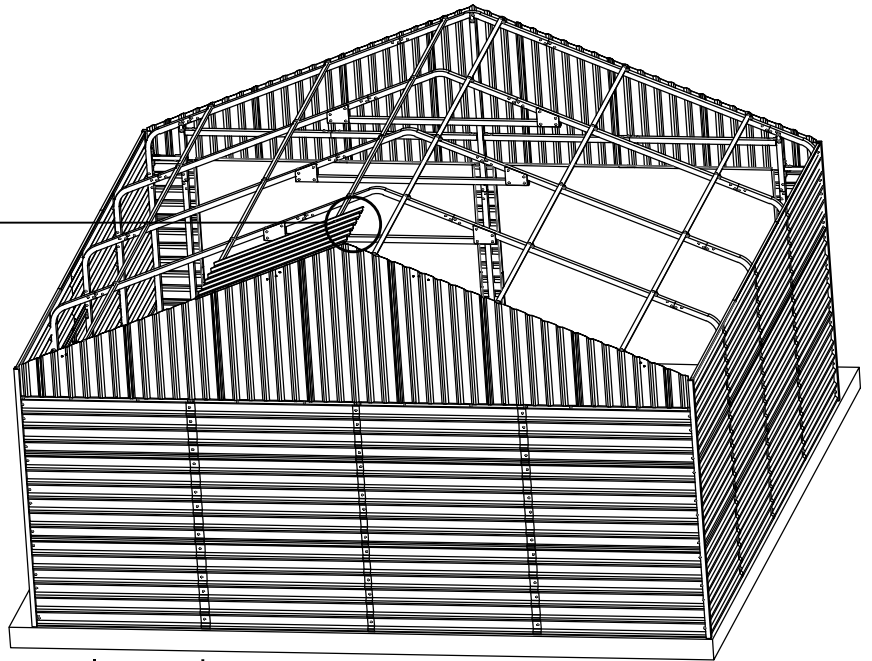
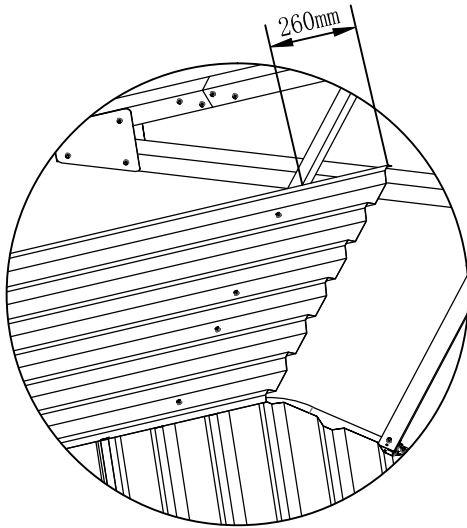

# PANEL ASSEMBLY- ROOF

	P8A	1		S12	4
---	-----	---	---	-----	---



S12

When two panels overlap, make sure upper panel covers the lower panel.

	P7A	1		S12	12
---	-----	---	---	-----	----

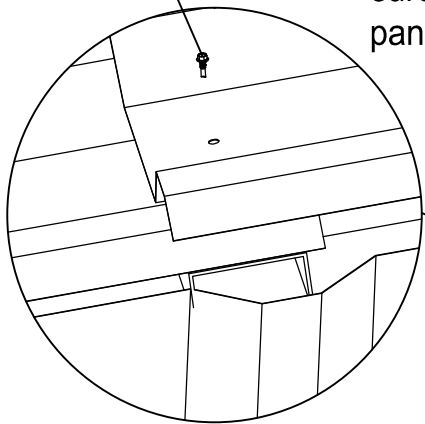



P7A

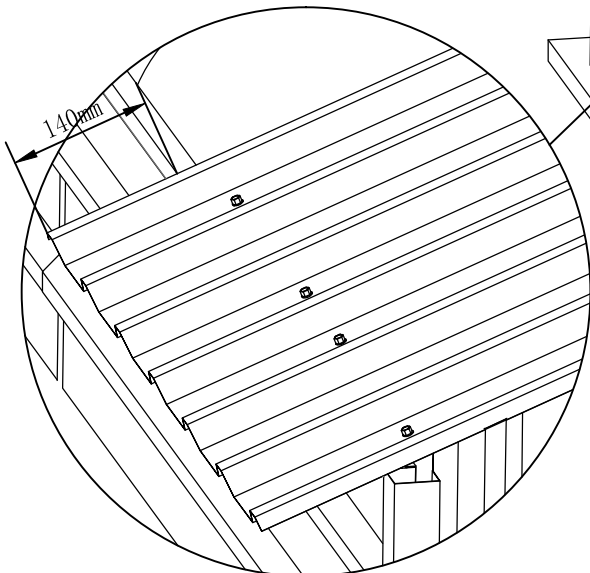
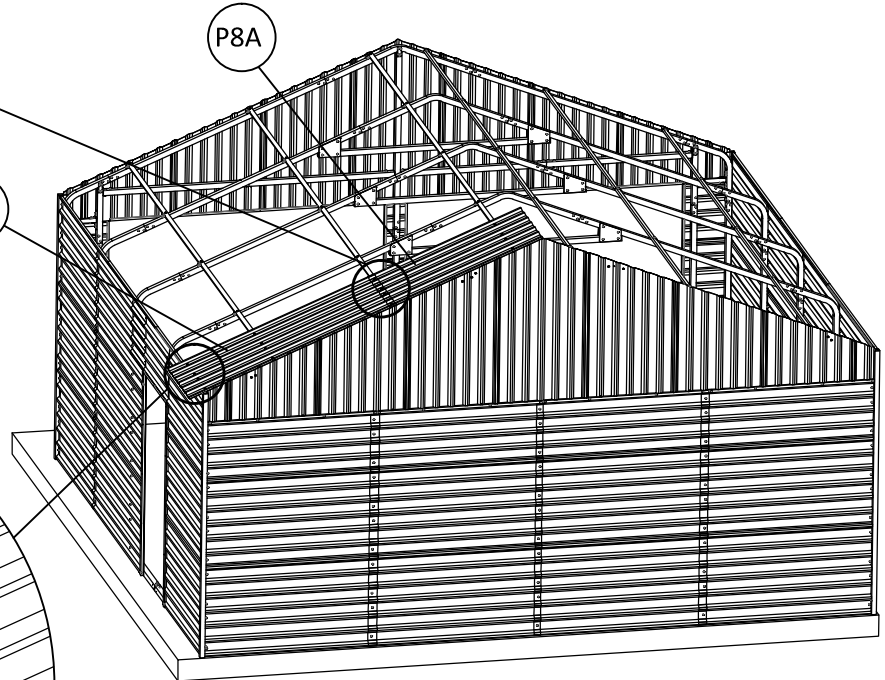

P8A

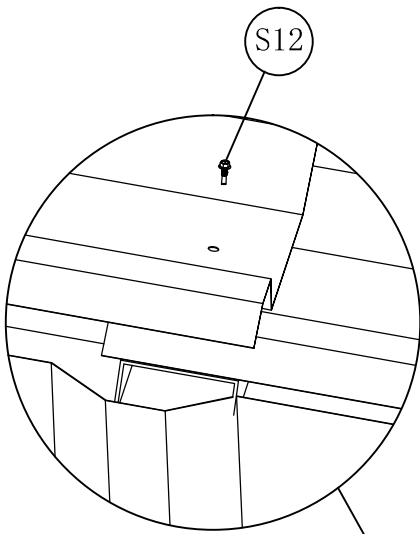
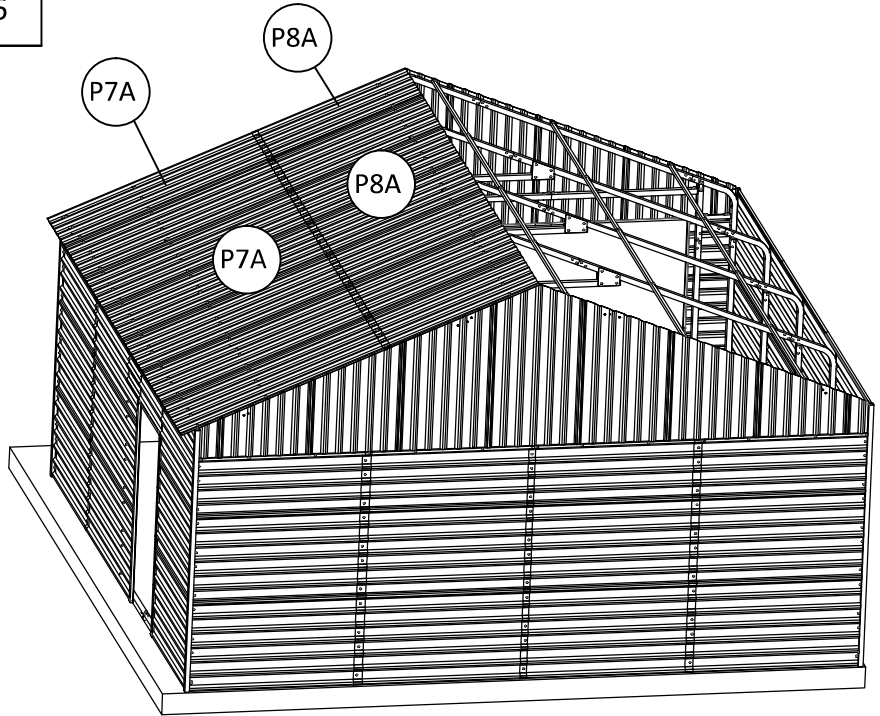

# PANEL ASSEMBLY- ROOF

	P7A	6		P8A	6
	S12	80			





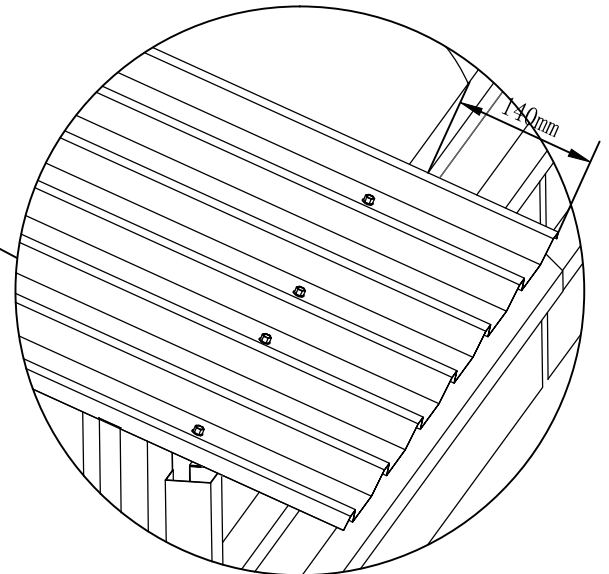
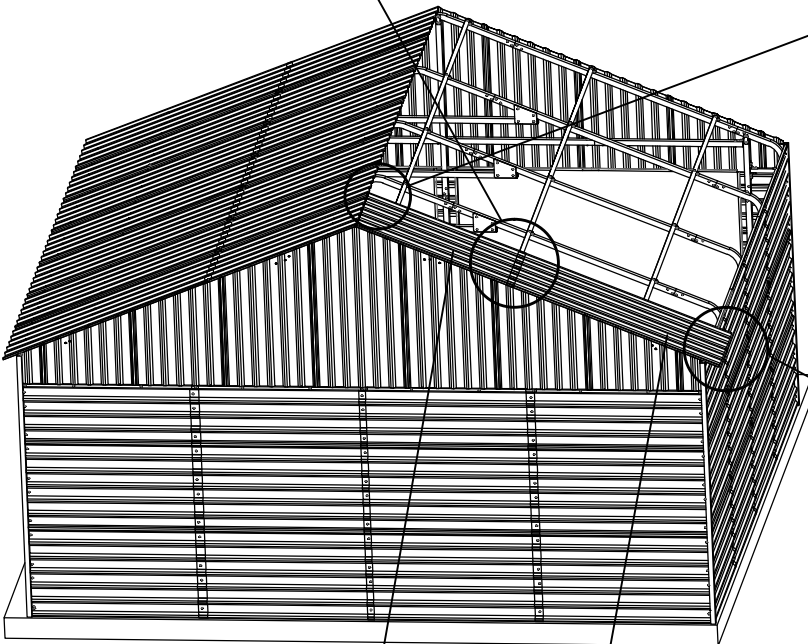
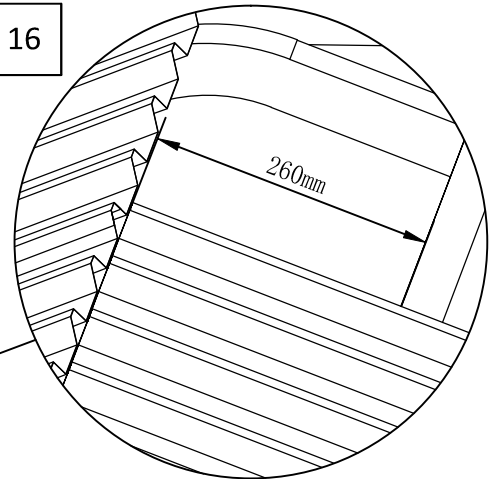

	P7A	1		S12	16
	P8A	1			







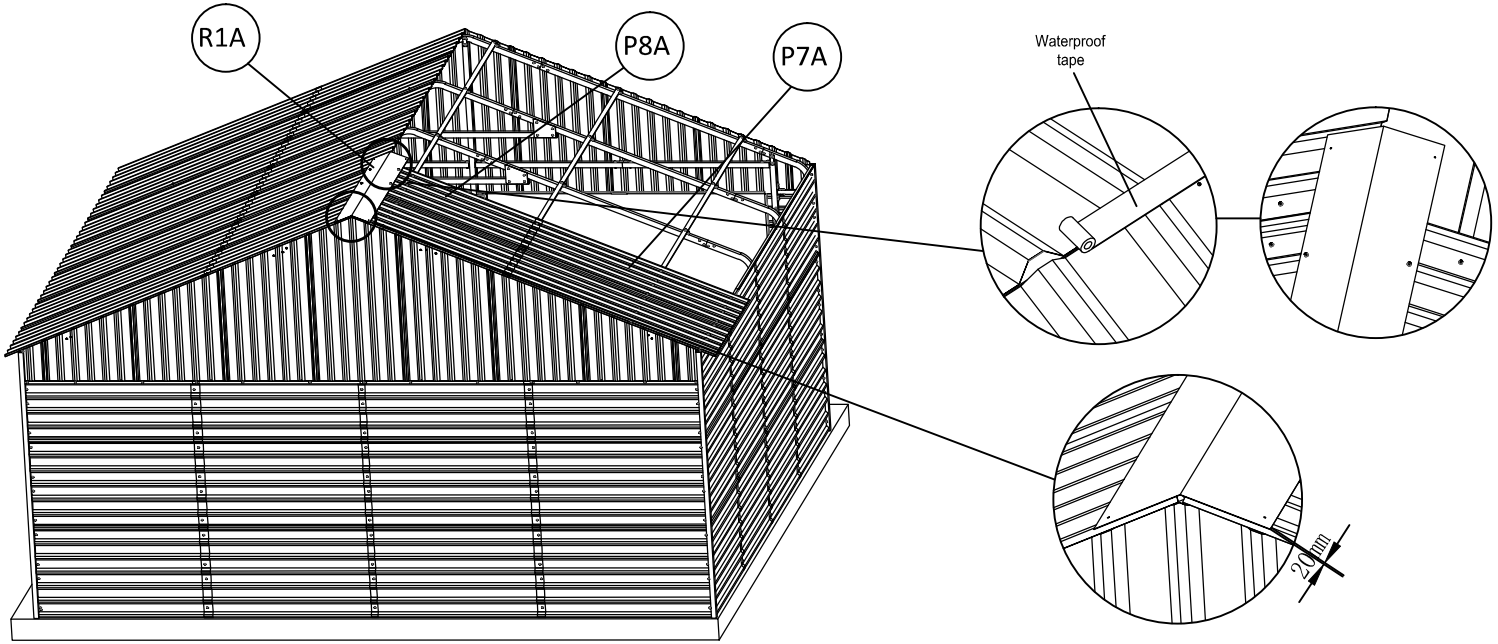

P8A

P7A

# PANEL ASSEMBLY- ROOF

	P7A	1		P8A	1		R1A	1		S12	20		Waterproof tape
---	-----	---	---	-----	---	---	-----	---	--	-----	----	---	-----------------





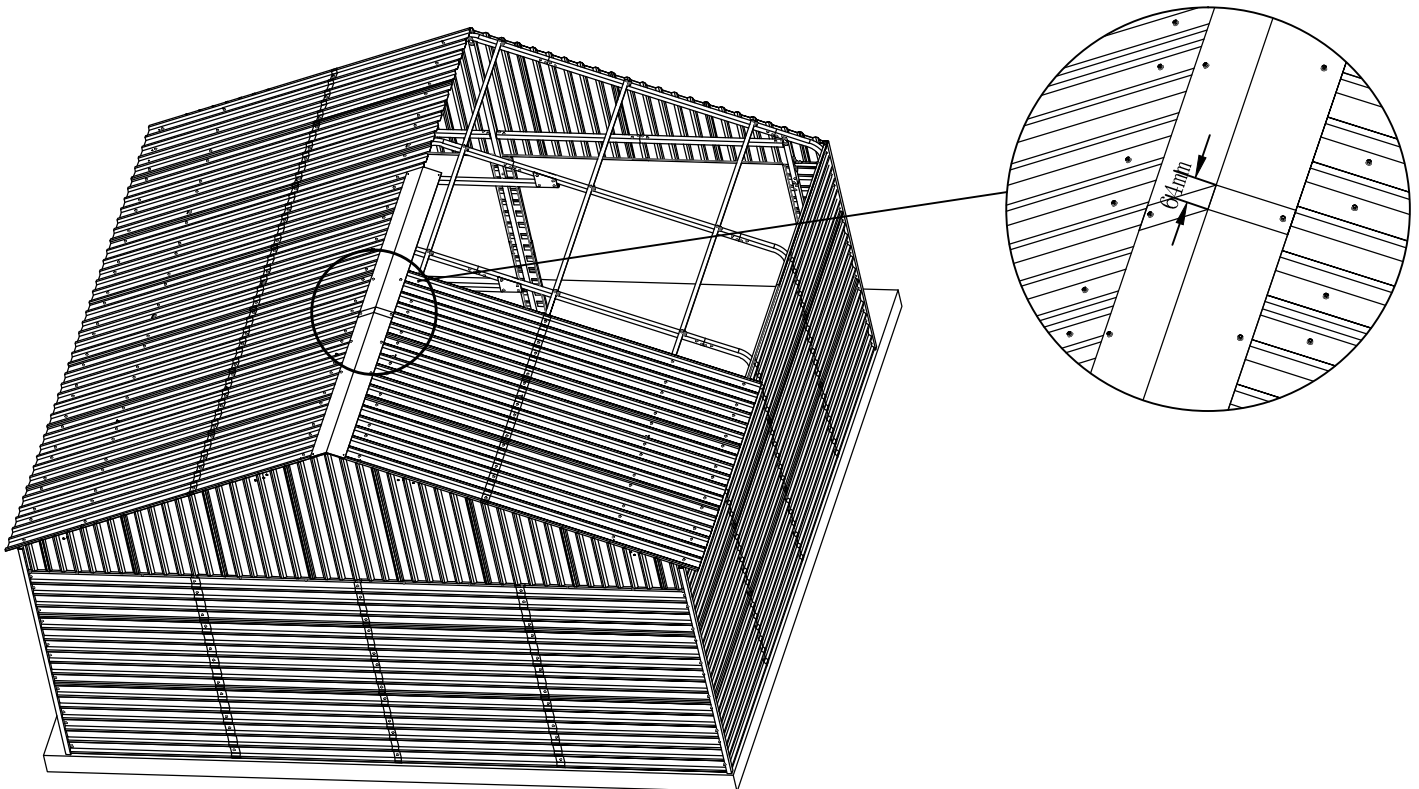

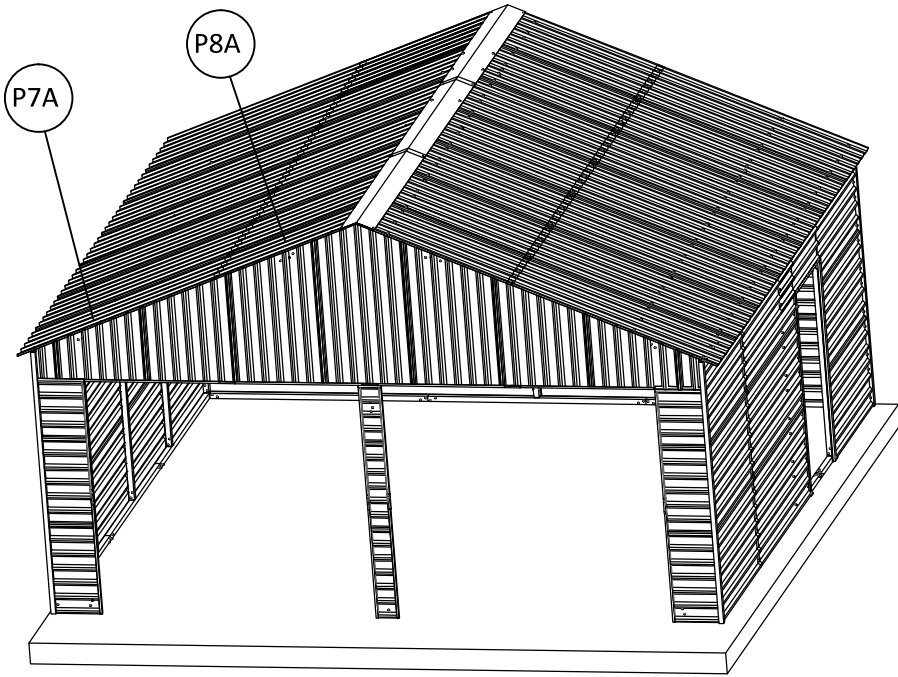

	P7A	1		P8A	1		R1A	1		S12	20		Waterproof tape
--	-----	---	--	-----	---	--	-----	---	--	-----	----	--	-----------------



# SHED ASSEMBLY- ROOF



	P7A	4		P8A	4
	S12	54		R1A	1
	Waterproof tape				

	L1B	6		S12	20
---	-----	---	---	-----	----

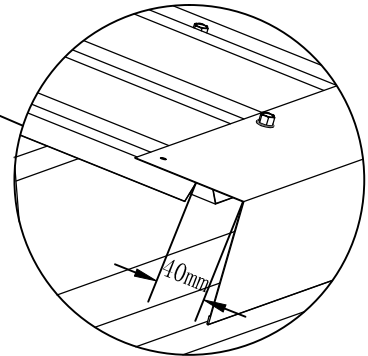
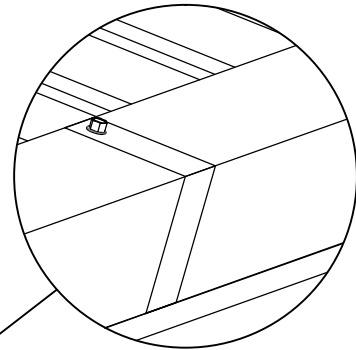
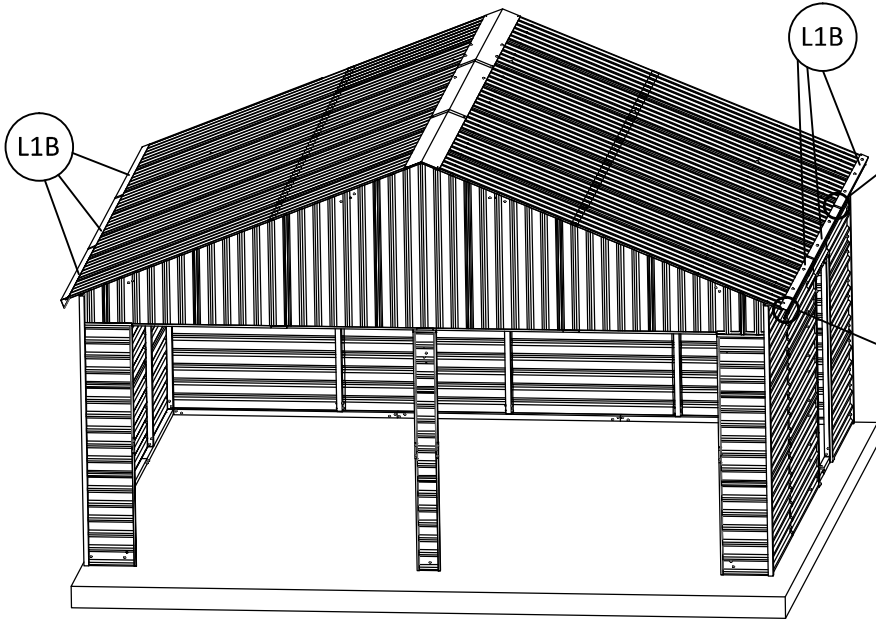



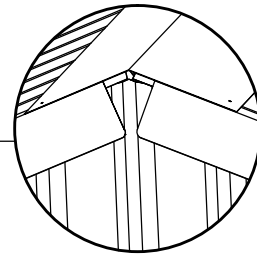
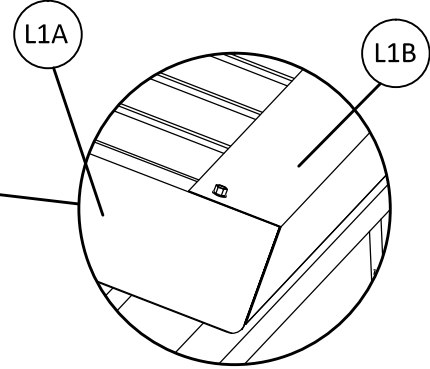
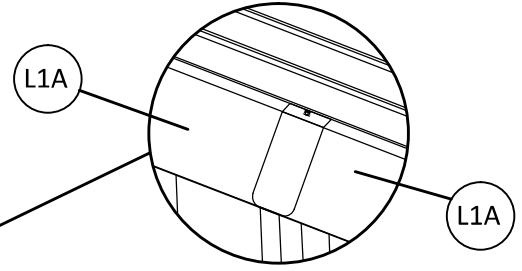
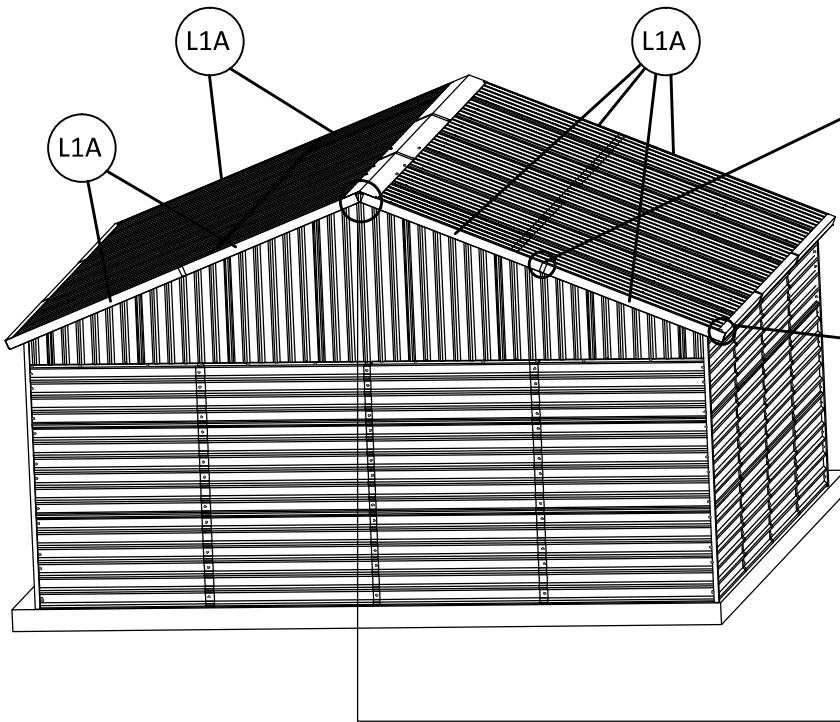

# SHED ASSEMBLY- ROOF

	L1A	8		S12	20
---	-----	---	---	-----	----





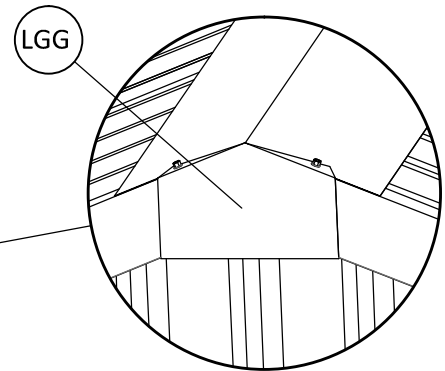
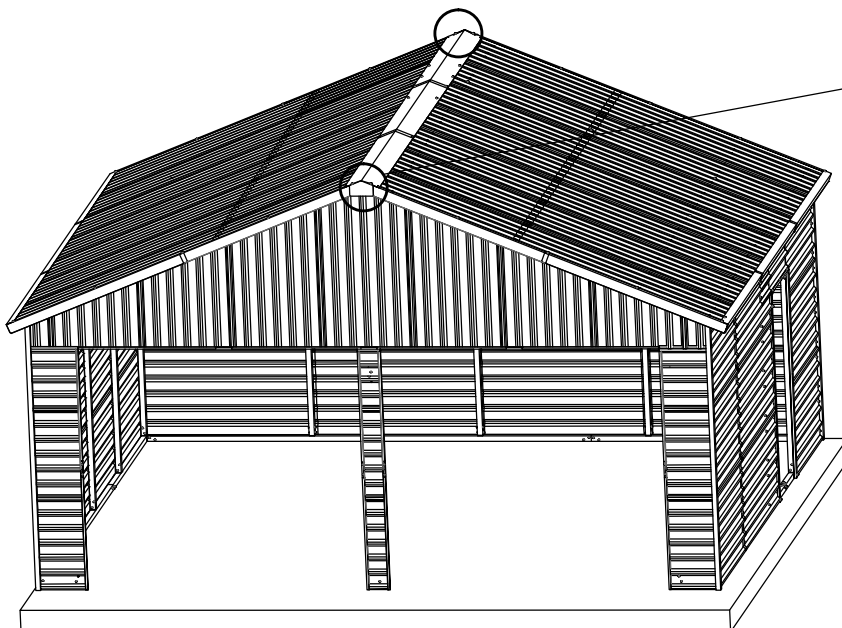



	LGG	2		S12	4
---	-----	---	---	-----	---





# DOOR ASSEMBLY - SIDE DOOR

STEP 1.

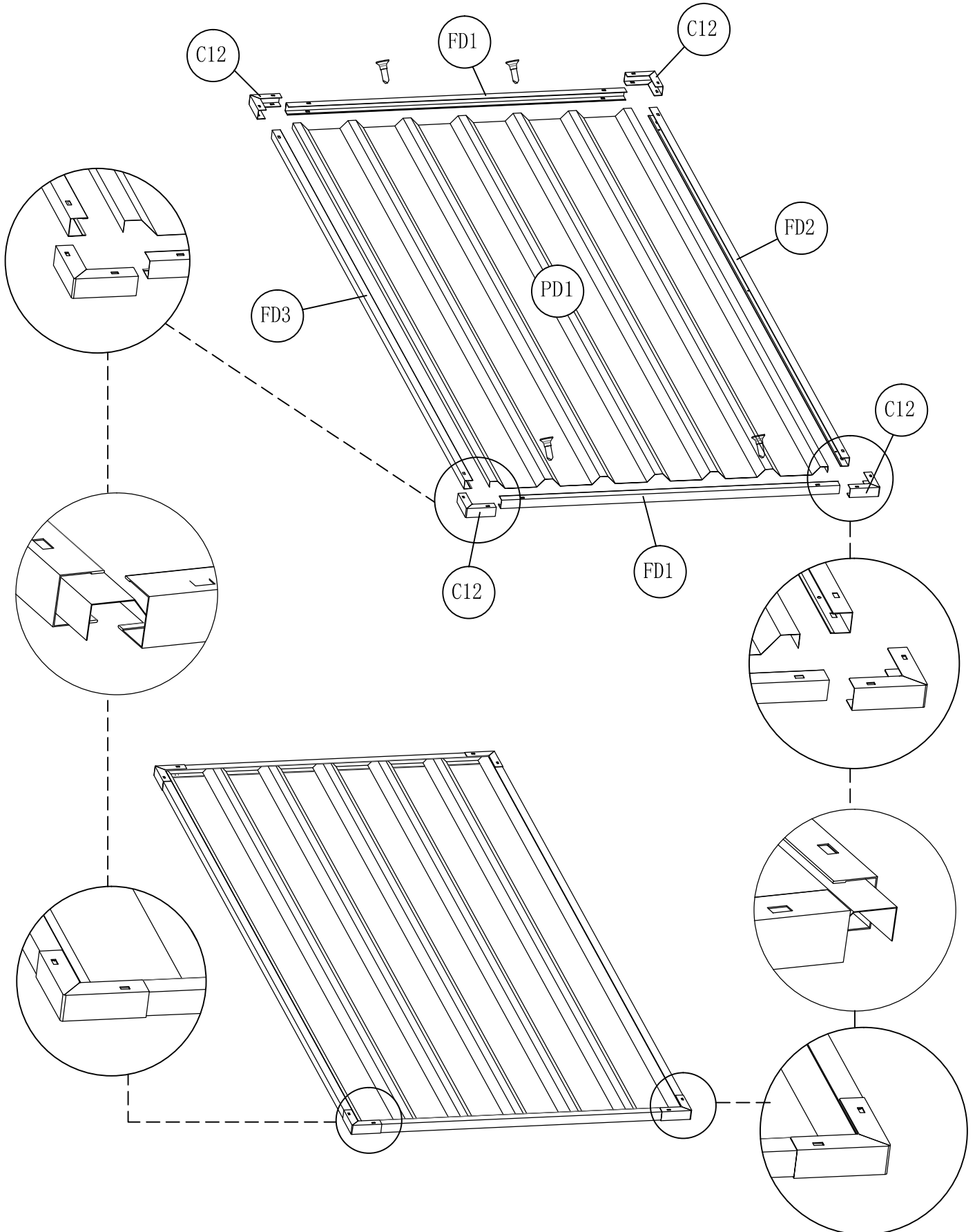
	PD1	1		FD1	2		FD3	1
	C12	4		FD2	1		S1	4

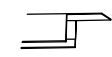
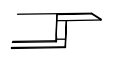

# DOOR ASSEMBLY - SIDE DOOR

	FDU1	1		FDU2	2
	S1	6		L1A	6

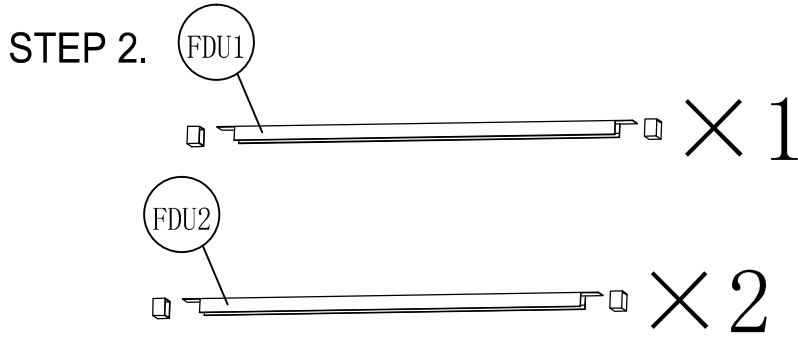



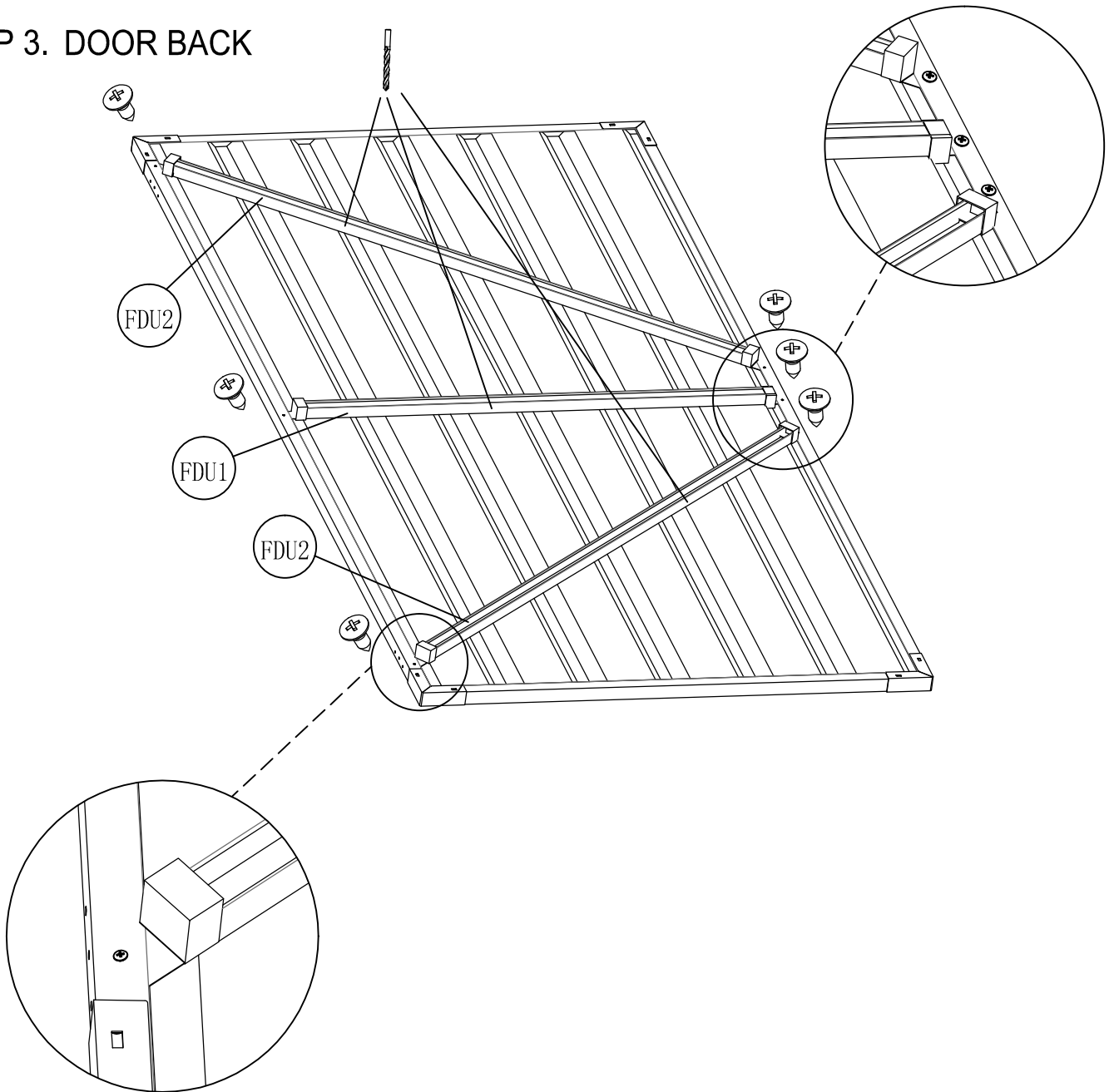

## STEP 3. DOOR BACK

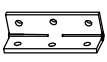

# DOOR ASSEMBLY - SIDE DOOR

## STEP 4. DOOR FRONT

	SH1	2		S1	18
	S16	6		L3	18
	MSA	2			

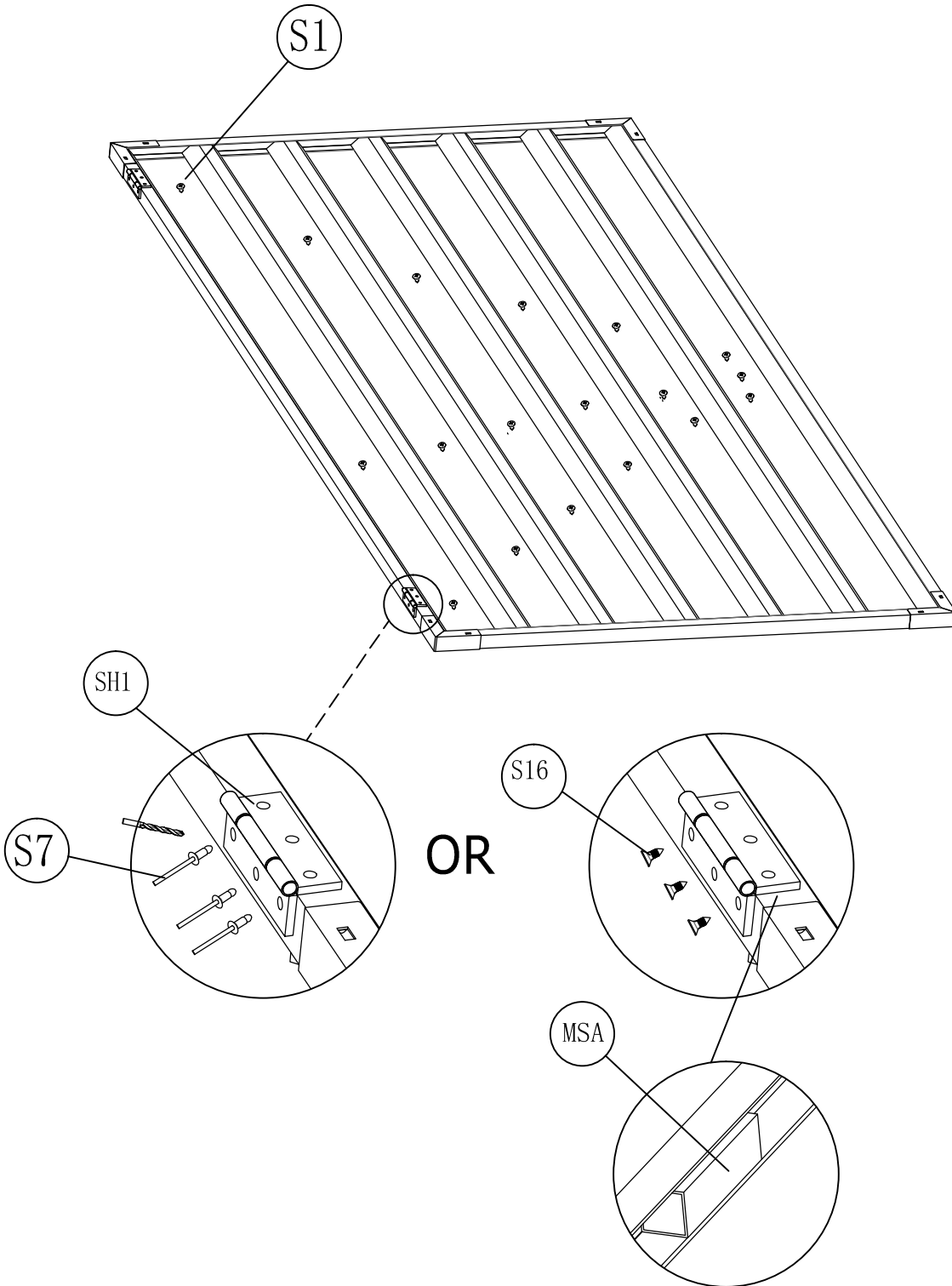

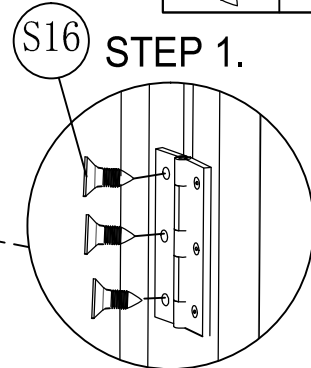
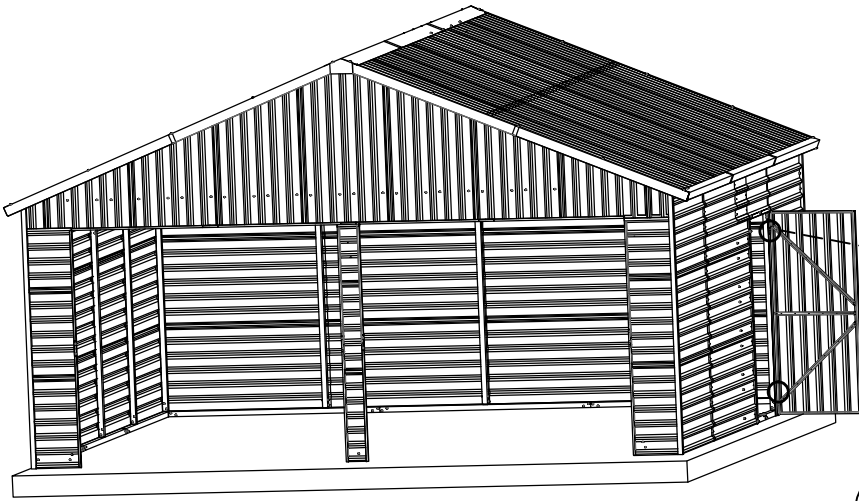

Adjust the position of the door, mark on TE1 and use the drill to drill through, then use S7 or S16 to connect.

	S16	12
---	-----	----

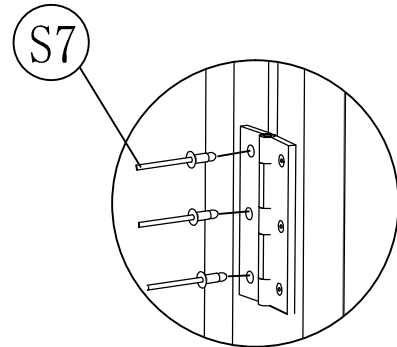

OR





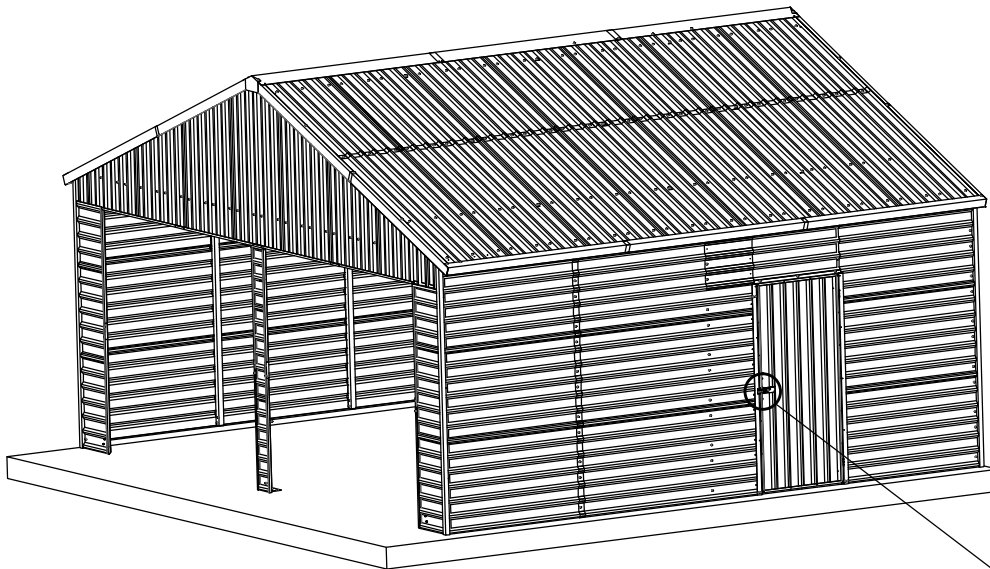

	H1	1
	S16	6

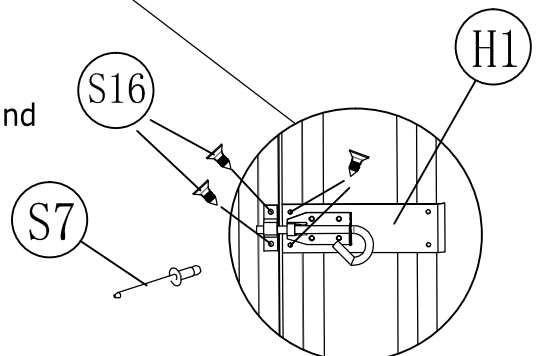

Install the latch in position as shown and fix with S16 or S7.



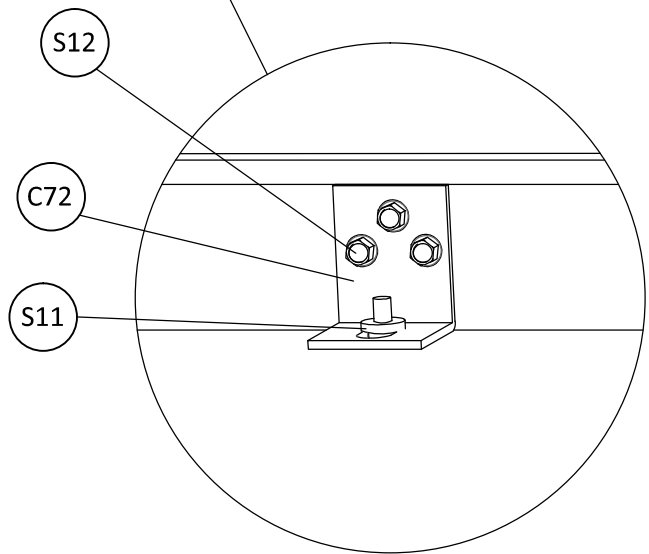
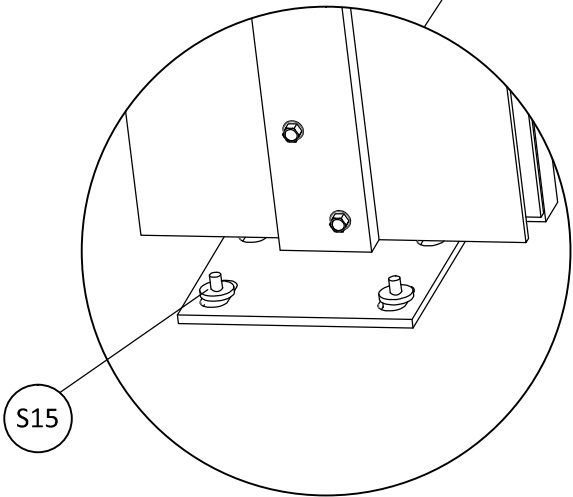
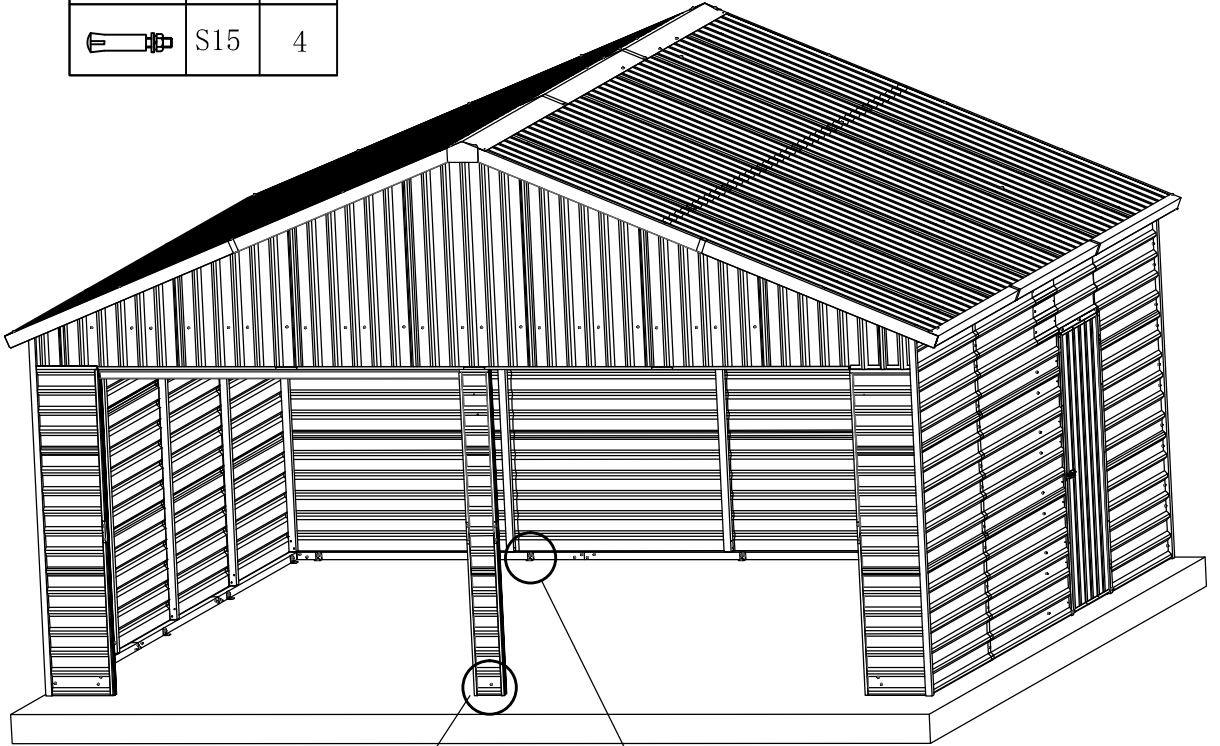

# SHED ASSEMBLY

	C72	14		S12	42
	S11	14			
	S15	4			





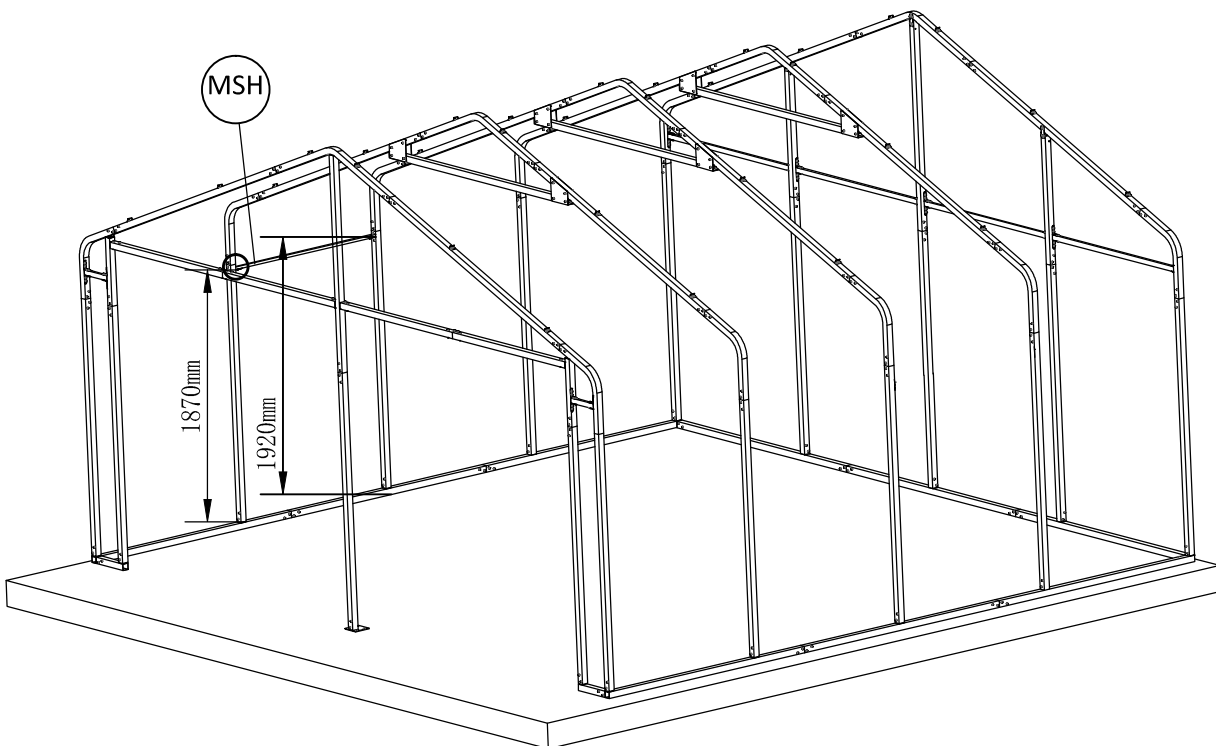
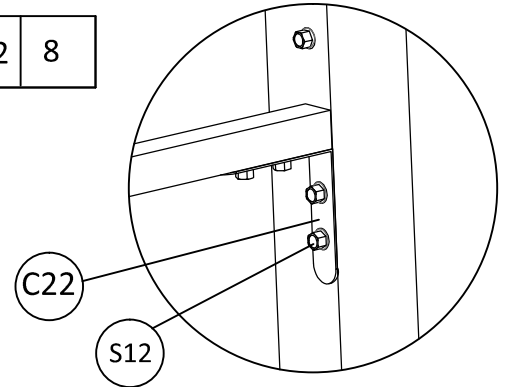

# FRAME ASSEMBLY - INSTALL THE SIDE DOOR ON THE LEFT

If you want to install the side door on the left, please follow the steps on this page.

	MSH	1		C22	2		S12	8
---	-----	---	---	-----	---	---	-----	---



# FRAME ASSEMBLY - BEAM PART

	B1467	12		B1432	12		S12	60		S13	48
---	-------	----	---	-------	----	---	-----	----	---	-----	----

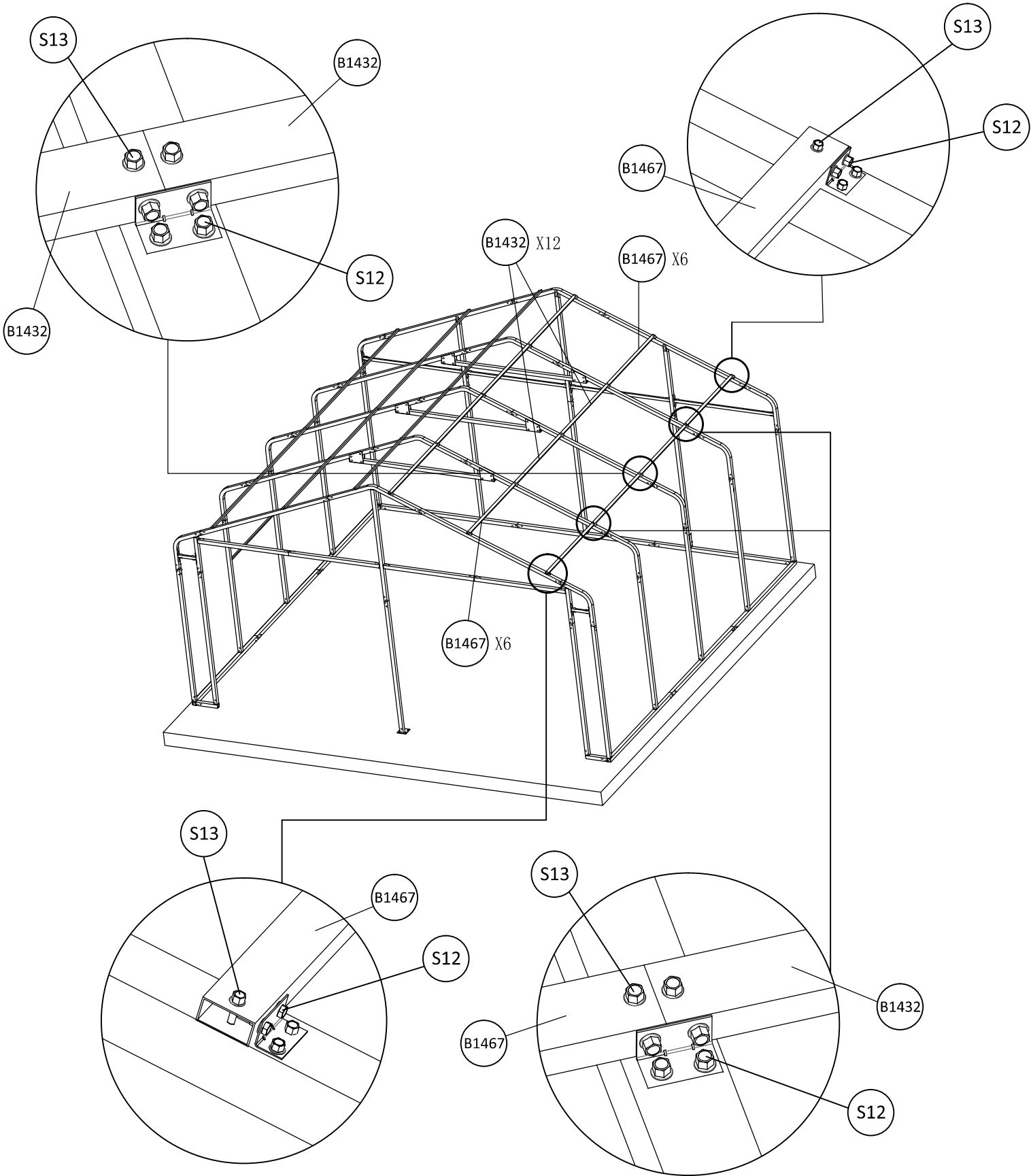



# FRAME ASSEMBLY

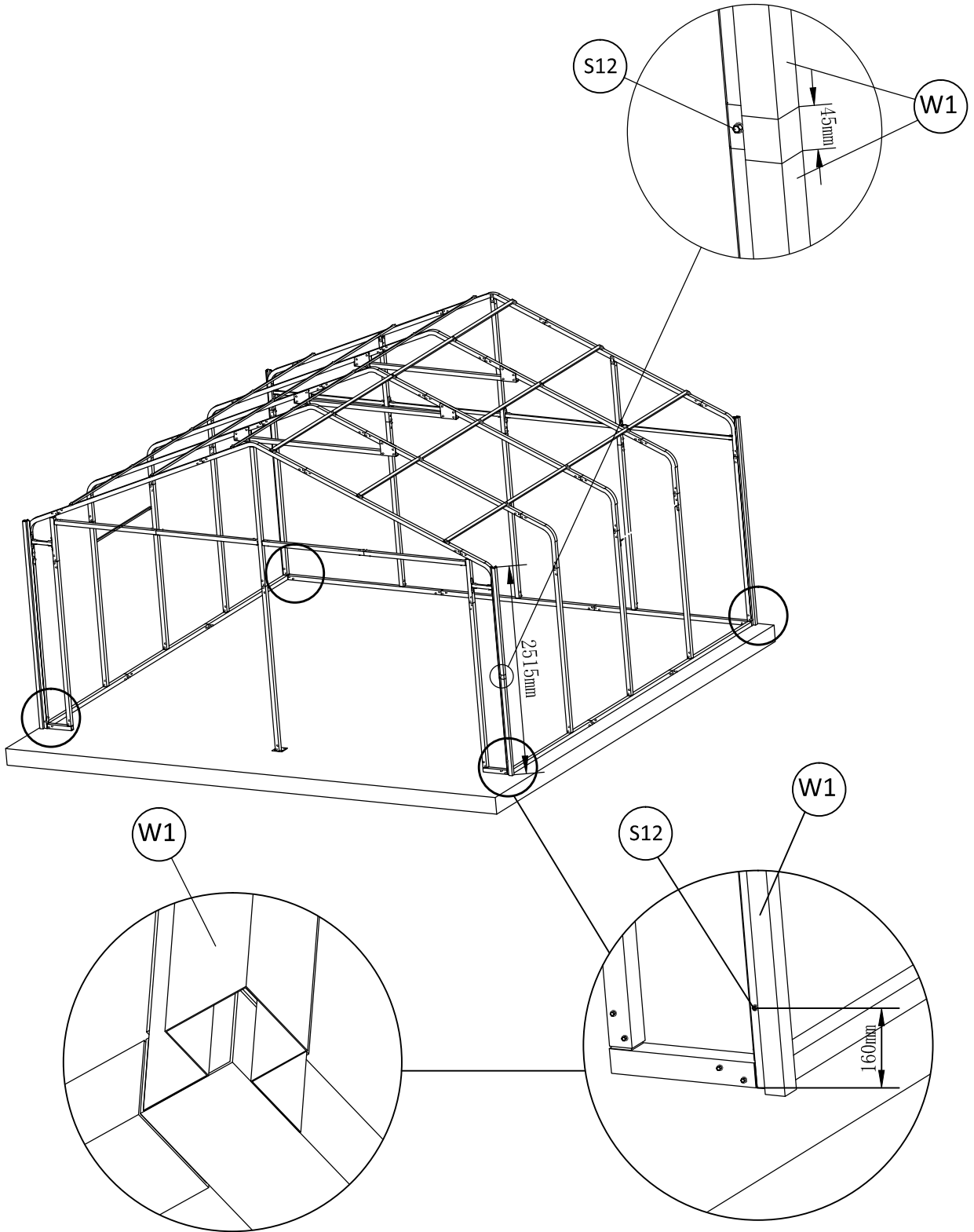

	W1	8		S12	16
---	----	---	---	-----	----



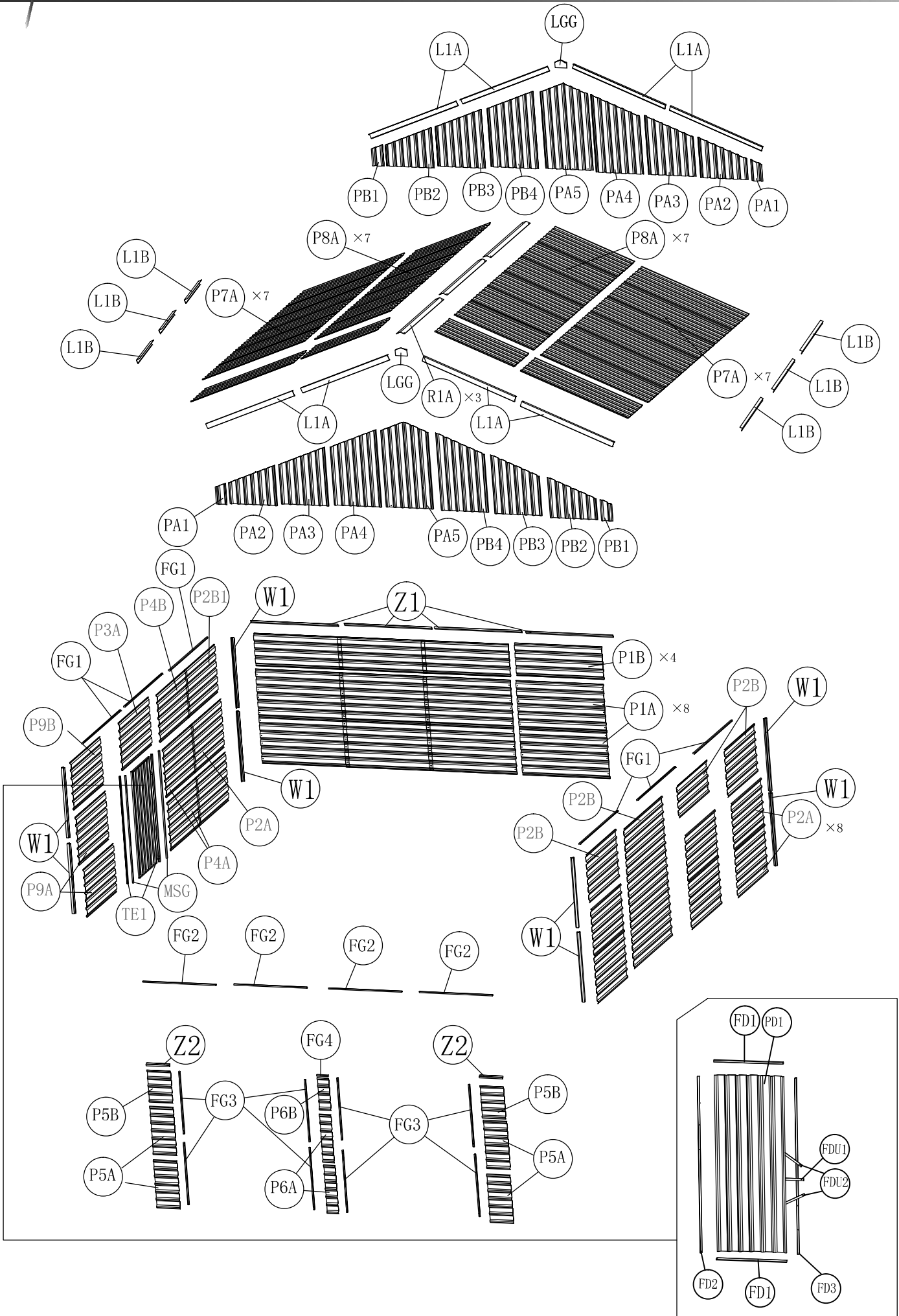

# PANEL ASSEMBLY



# PANEL ASSEMBLY - BACK WALL

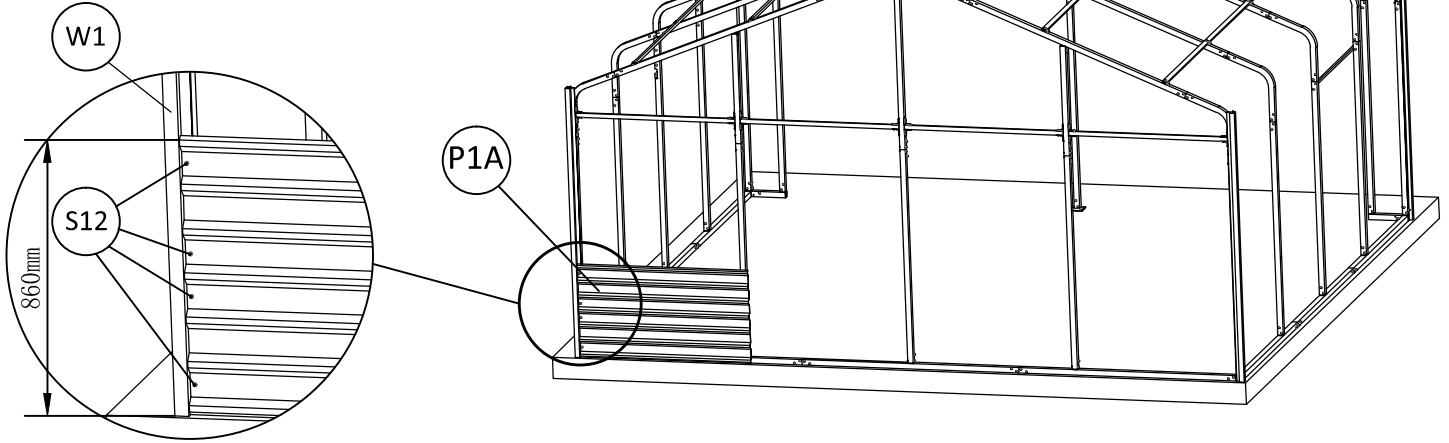

	P1A	1		S12	4
---	-----	---	---	-----	---



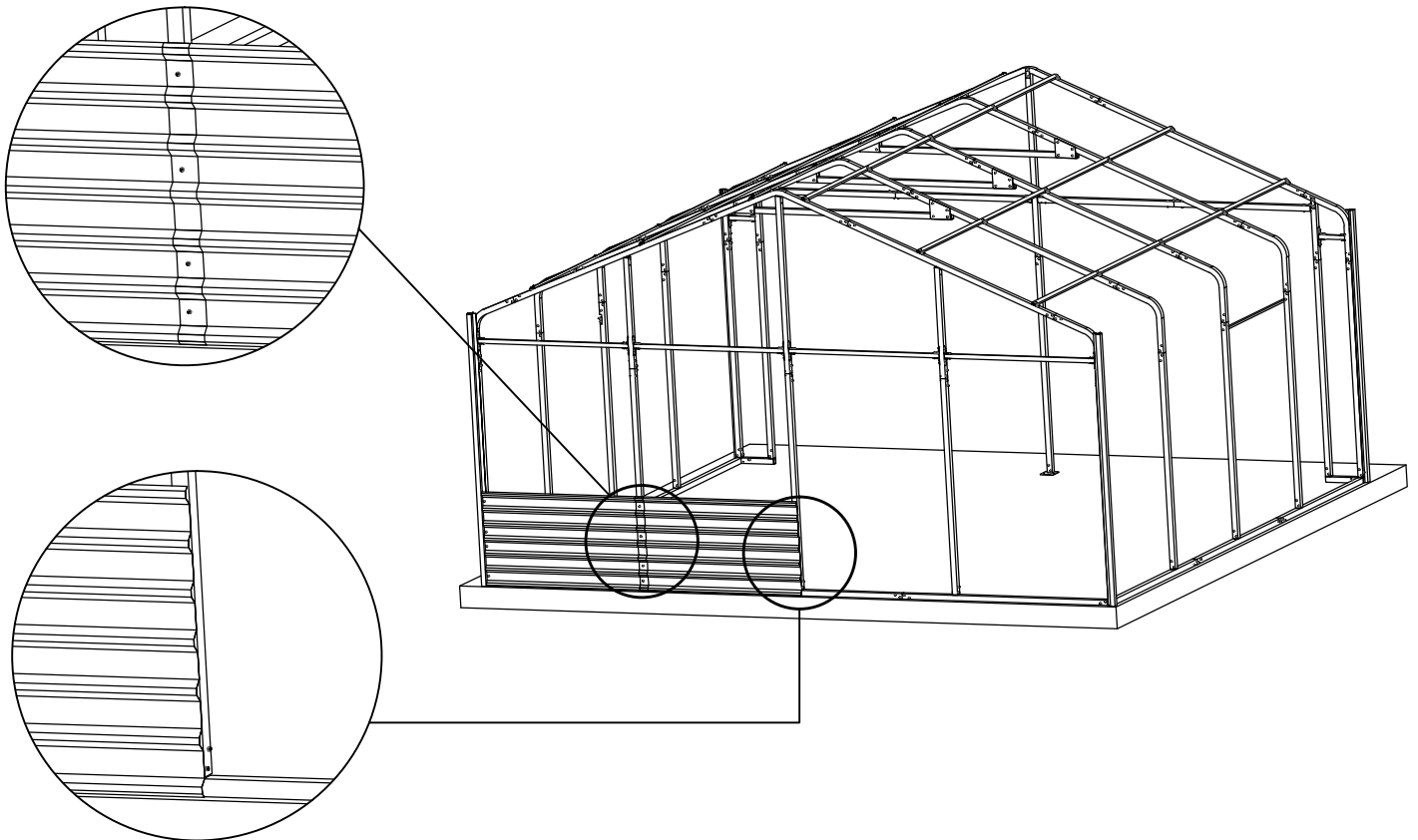

	P1A	1		S12	4
--	-----	---	---	-----	---

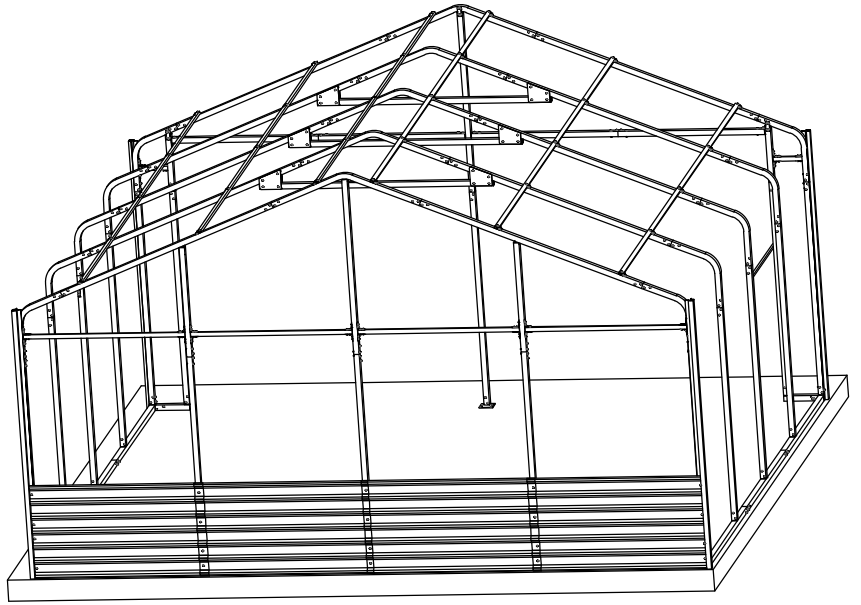

# PANEL ASSEMBLY - BACK WALL

	P1A	2		S12	12
---	-----	---	---	-----	----





	P1A	4		S12	20
--	-----	---	---	-----	----

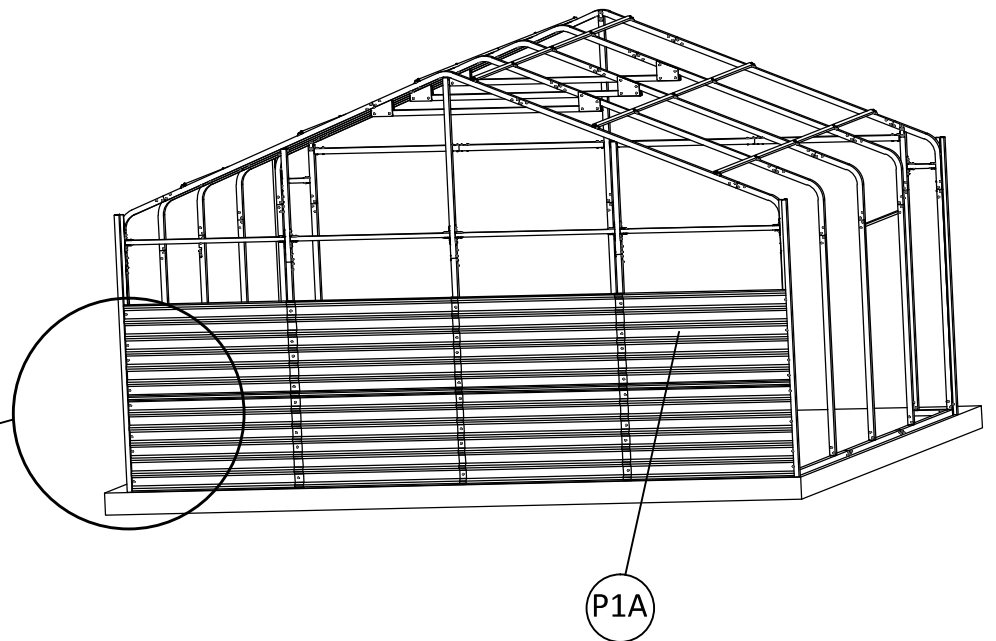
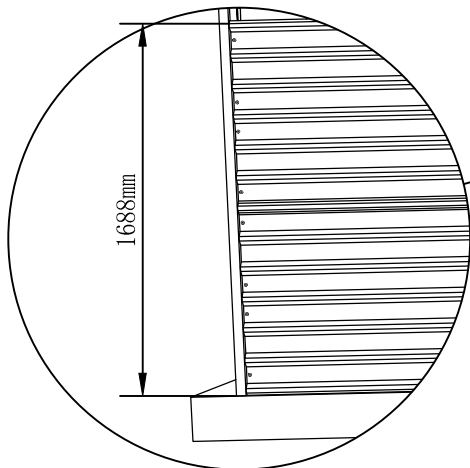
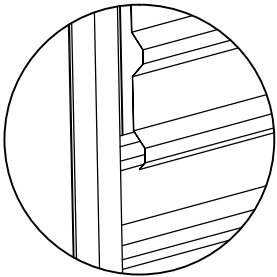

When two panels overlap, make sure upper panel covers the lower panel.

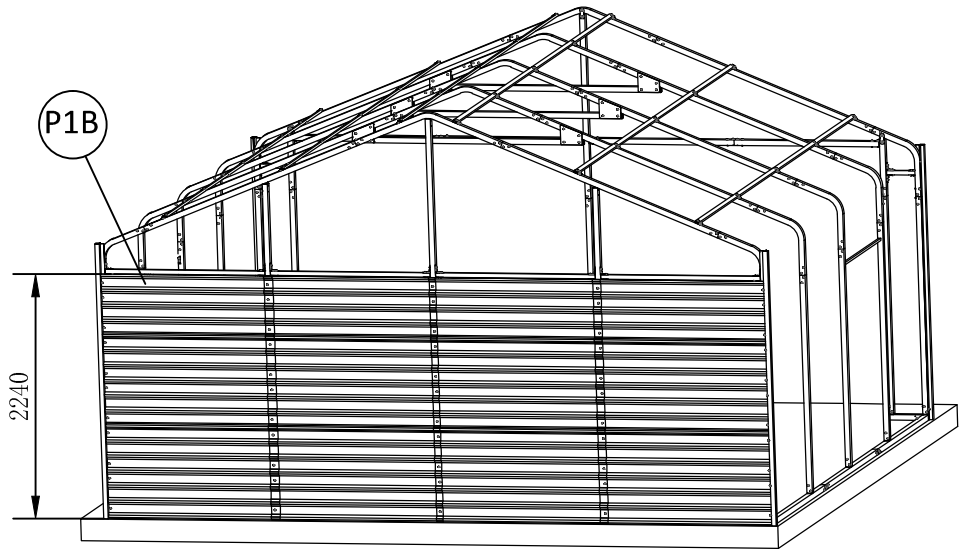
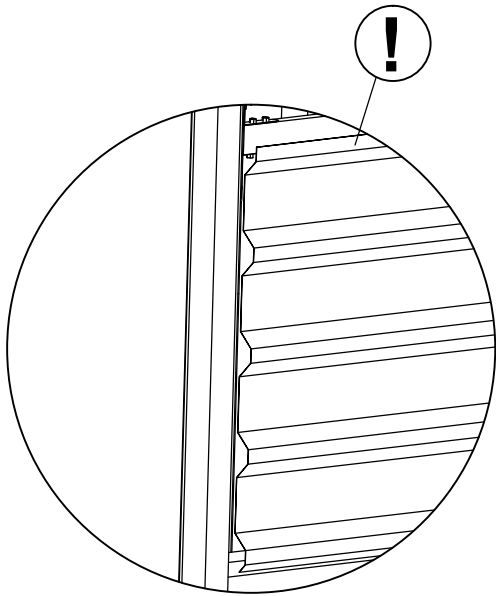

# PANEL ASSEMBLY - BACK WALL

	P1B	4		S12	20
---	-----	---	---	-----	----



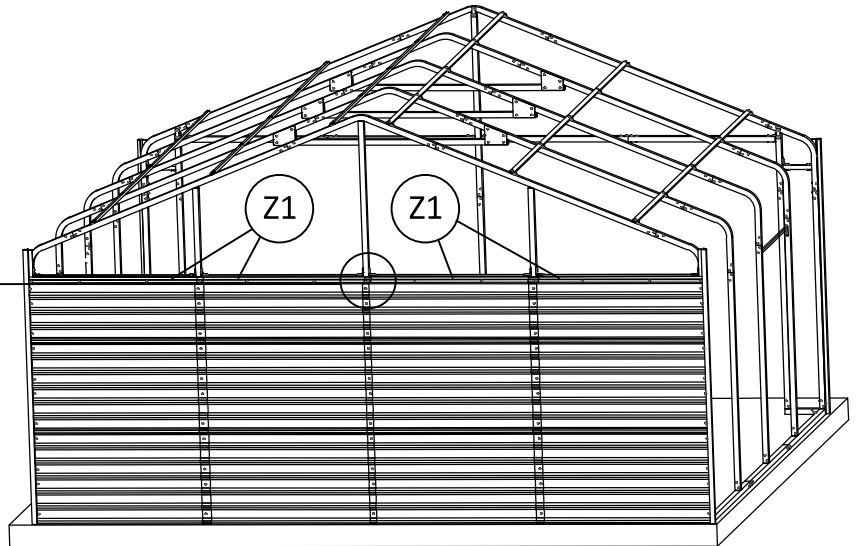
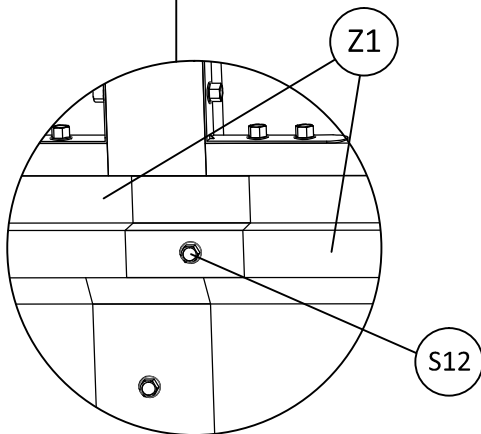
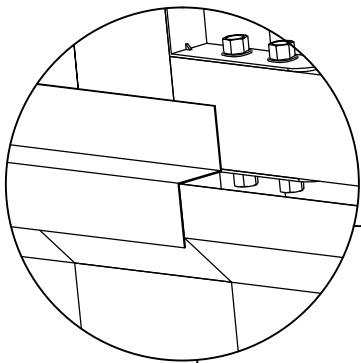

	Z1	4		S12	13
---	----	---	---	-----	----



# PANEL ASSEMBLY - RIGHT WALL

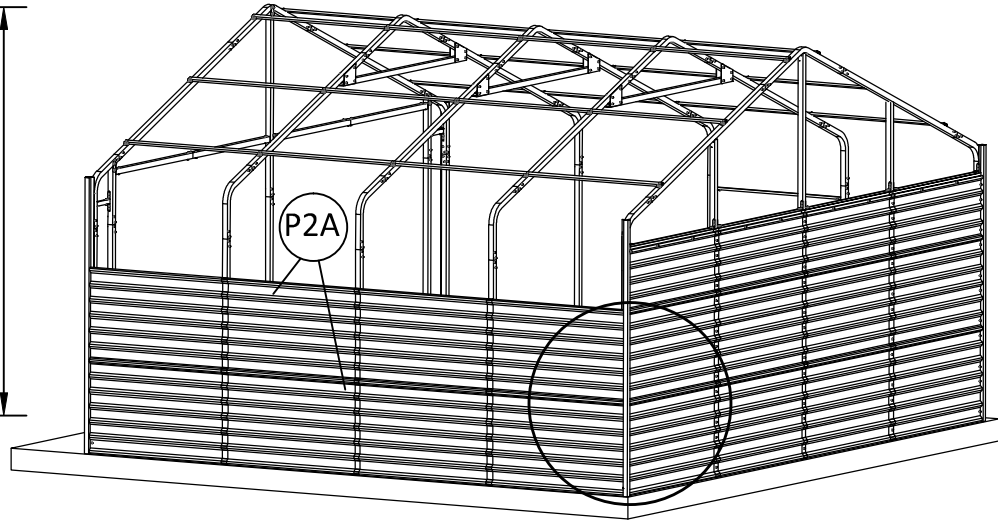
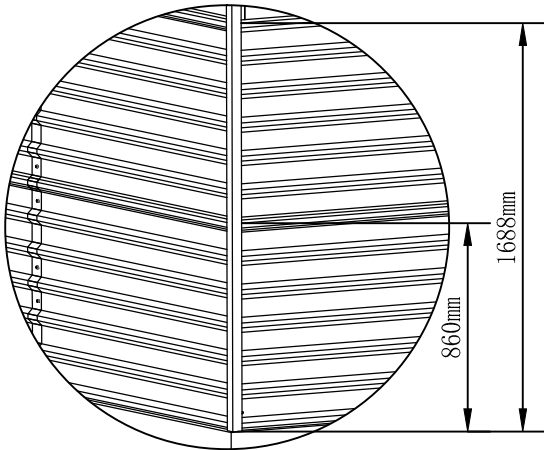

	P2A	8		S12	40
---	-----	---	---	-----	----



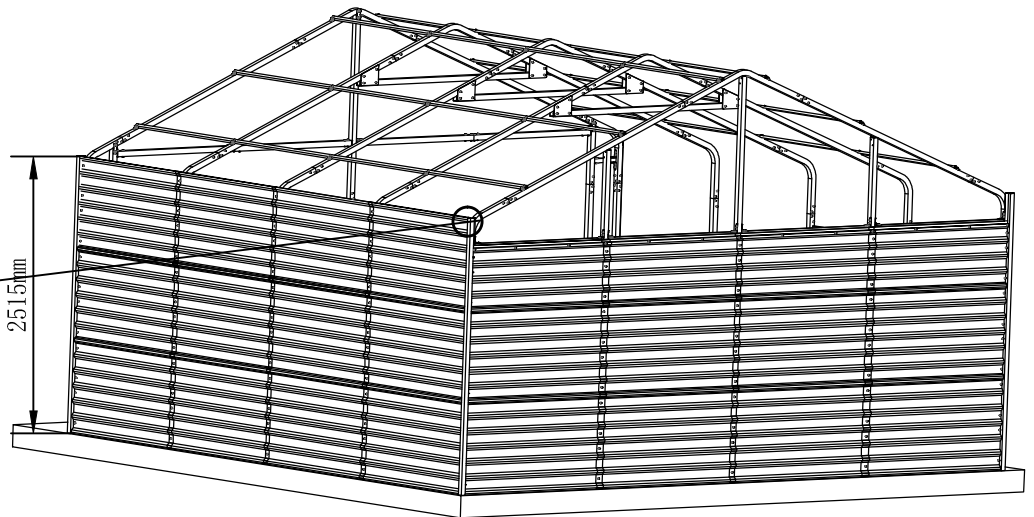
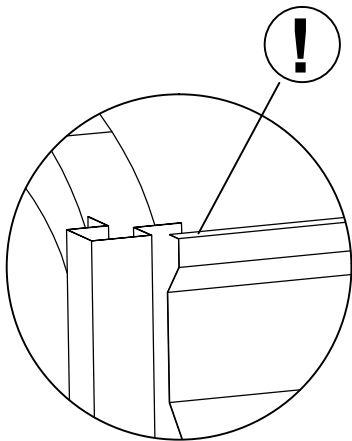



	P2B	4		S12	20
---	-----	---	---	-----	----

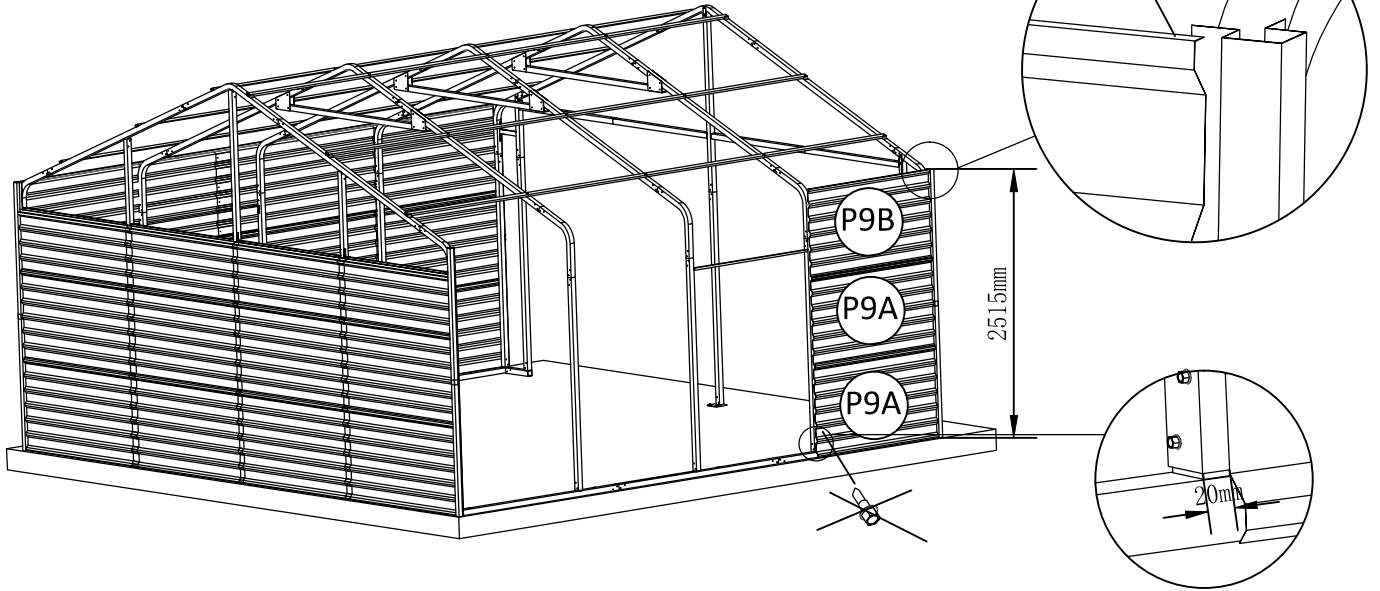

# PANEL ASSEMBLY - LEFT WALL

	P9A	2		P9B	1		S12	12
---	-----	---	---	-----	---	---	-----	----



4	TE1	1		MSG	1		S13	5		S12	5
---	-----	---	---	-----	---	---	-----	---	---	-----	---

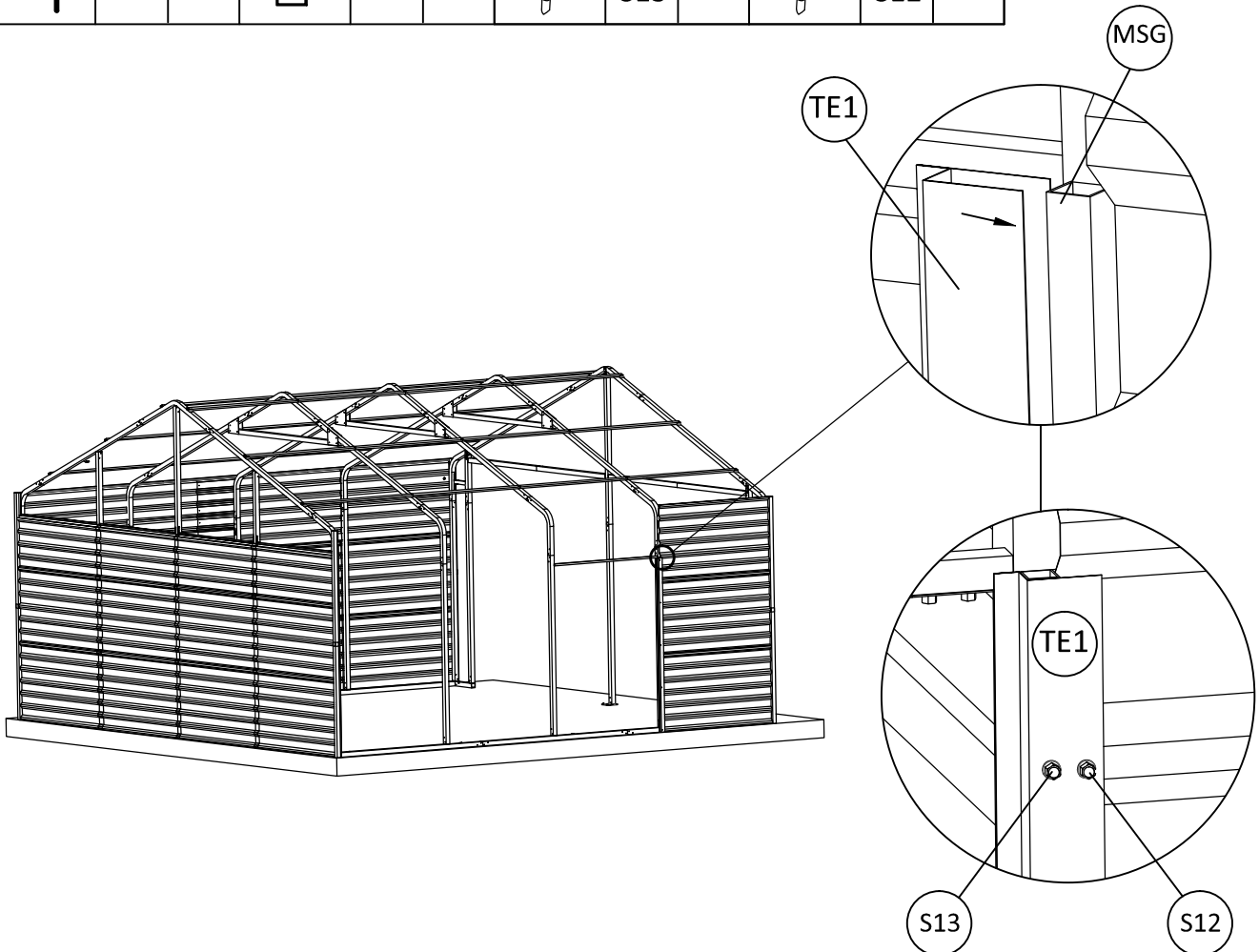

# PANEL ASSEMBLY - LEFT WALL

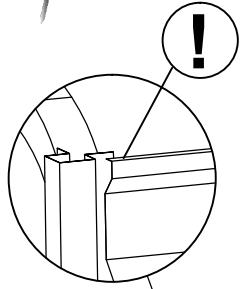

	P4A	2		P4B	1		S12	33
	P2A	2		P2B1	1			

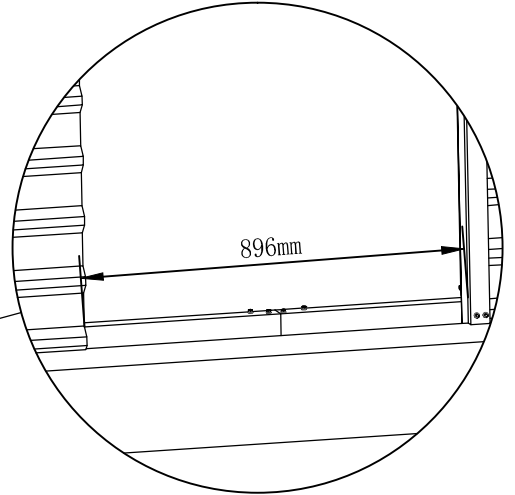
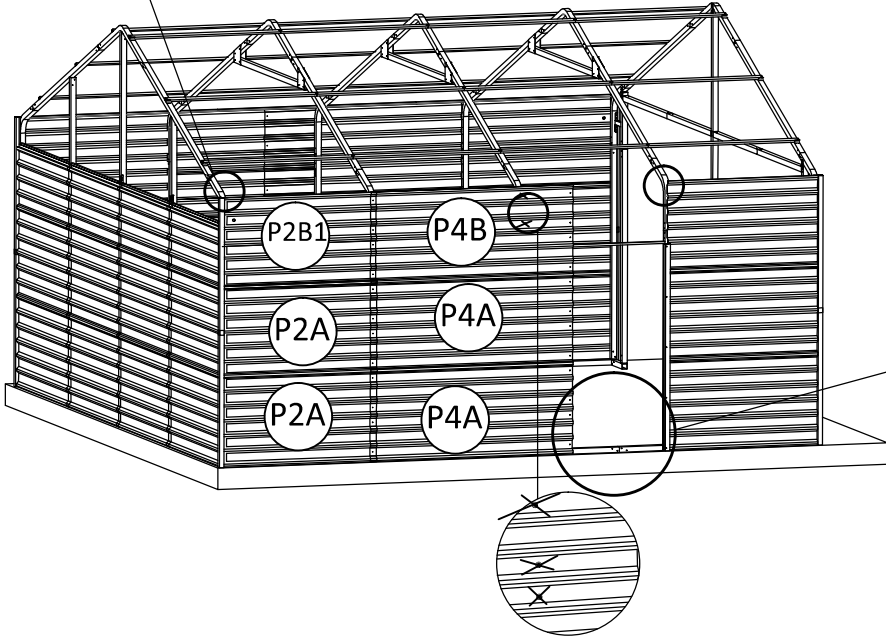
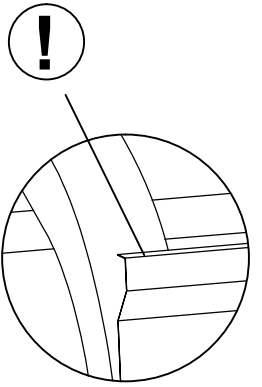



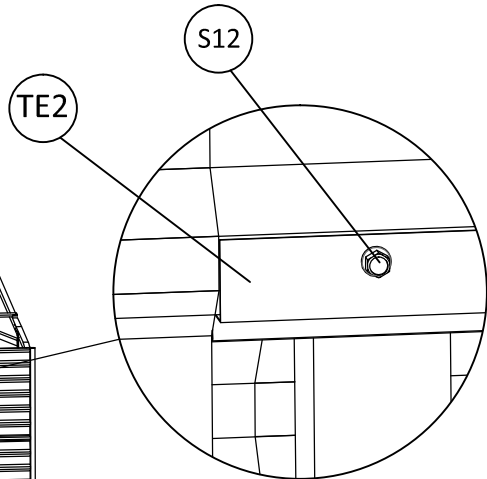
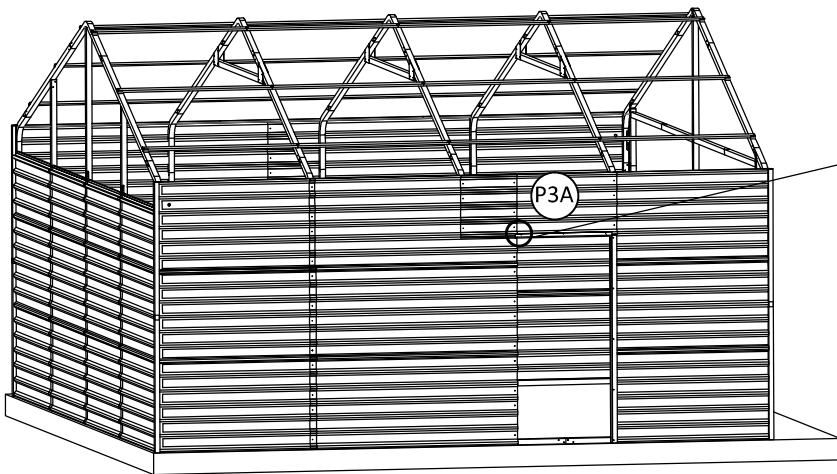

	P3A	1		S12	9		TE2	1
--	-----	---	--	-----	---	--	-----	---





# PANEL ASSEMBLY - LEFT WALL

For next step, please refer to page 29.

	TE1	1		S12	8		S13	2
	MSG	1						

