

ZERO GRAVITY MULTI-FUNCTION RECLINER MASSAGE CHAIR

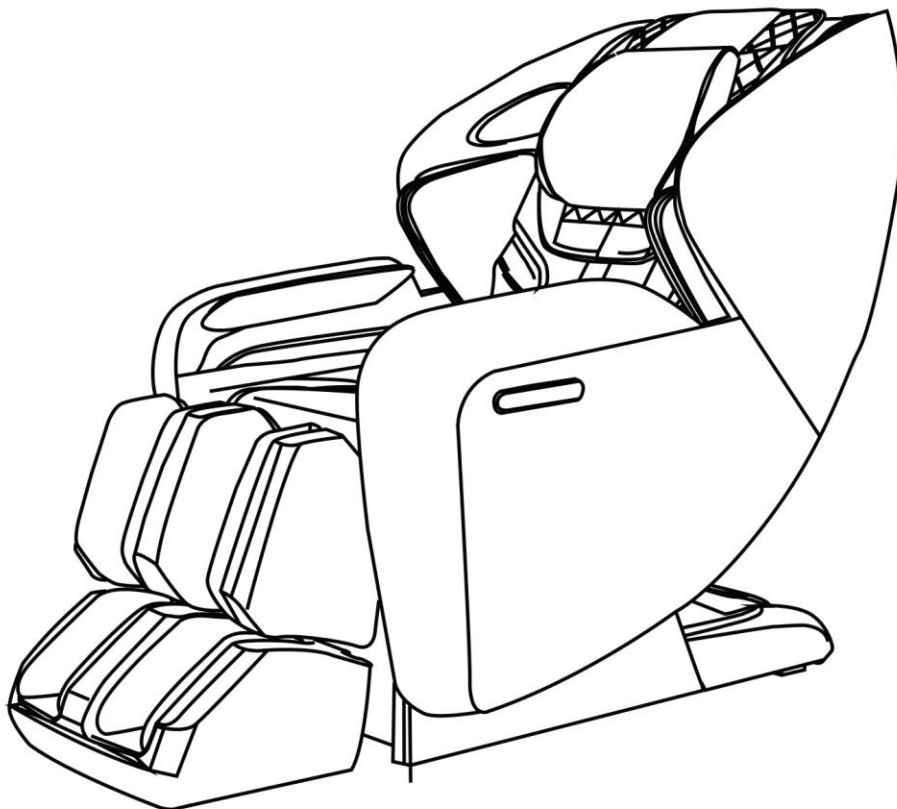

WARNING



- Please read and understand the product manual completely before assembly
- Check against the parts list to make sure all parts are received
- Wear proper safety goggles or other protective gears while in assembly
- Do not return the product to dealer. They are not equipped to handle your requests.

Missing parts or have questions on assembly?

Please call: 1-877-761-2819 or email: cs@tmgindustrial.com

HEADING 1

TITLE OF BODY TEXT

Body text,

Please call: 1-877-761-2819 or email: cs@tmgindustrial.com

 **CONTENTS**

IMPORTANT SAFETY INSTRUCTIONS.....2

SAFETY PRECAUTIONS.....3

NAME AND FUNCTION OF EACH COMPONENT..... 5

 External Structure..... 5

 Internal Structure5

 Power Box.....6

 Controller7

 Controller Instructions8

 Display Screen Instructions.....10

PRELIMINARY CHECKS.....15

 Position & Placement for Installation.....15

 Floor Protection..... 16

 Surrounding Environment..... 16

 Grounding.....16

 Installation Method16

 Moving the Massage Chair18

 Connecting to Power18

 Commissioning19

 Before Sitting in the Chair.....19

 After Use19

CARE AND MAINTENANCE20

TROUBLESHOOTING22

TECHNICAL SPECIFICATIONS.....22

IMPORTANT SAFETY INSTRUCTIONS

Read all instructions before using (this appliance).

DANGER - To reduce the risk of electric shock:

1) Always unplug this appliance from the electrical outlet immediately after using and before cleaning.

WARNING - To reduce the risk of burns, fire, electric shock, or injury to persons:

- 1) An appliance should never be left unattended when plugged in. Unplug from outlet when not in use, and before putting on or taking off parts.
- 2) Do not operate under blanket or pillow. Excessive heating can occur and cause fire, electric shock, or injury to persons.
- 3) Close supervision is necessary when this appliance is used by, on, or near children, invalids, or disabled persons.
- 4) Use this appliance only for its intended use as described in this manual. Do not use attachments not recommended by the manufacturer.
- 5) Never operate this appliance if it has a damaged cord or plug, if it is not working properly, if it has been dropped or damaged, or dropped into water. Return the appliance to a service center for examination and repair.
- 6) Do not carry this appliance by supply cord or use cord as a handle.
- 7) Keep the cord away from heated surfaces.
- 8) Never operate the appliance with the air openings blocked. Keep the air openings free of lint, hair, and the like.
- 9) Never drop or insert any object into any opening.
- 10) Do not use outdoors.
- 11) Do not operate where aerosol (spray) products are being used or where oxygen is being administered.
- 12) To disconnect, turn all controls to the off position, then remove plug from outlet.
- 13) Do not use massager in close proximity to loose clothing or jewelry.
- 14) Keep long hair away from massager while in use.
- 15) Use heated surfaces carefully. May cause serious burns, Do not use over insensitive skin areas or in the presence of poor circulation. The unattended use of heat by children or incapacitated persons may be dangerous..

SAVE THESE INSTRUCTIONS



For use household only

SAFETY PRECAUTIONS

SAFETY PRECAUTIONS

- ▶ Before using, please read the SAFETY PRECAUTIONS carefully to ensure correct operation of this appliance. Precautions and warnings listed below will help to ensure proper operation of this appliance.
- ▶ The classes of accidents caused by incorrect use are classified into WARNING and CAUTION. Read all

WARNINGS AND CAUTIONS BELOW AND FOLLOW ALL INSTRUCTIONS WITHIN THIS MANUAL.

	WARNING	Improper operation may cause injury to users.
	CAUTION	Improper operation may cause injury to users or damage to product.

	Prohibited		NO Disassemble
---	------------	---	----------------

NOT SUITABLE FOR BELOW PERSONS

We recommend that those with any of the following conditions should consult your physician before using.

 WARNING	<ul style="list-style-type: none"> ◆ Those with pacemaker or electronic devices implanted in the body. ◆ Those undergoing treatment, especially those who are not feeling well. ◆ Those with malignant tumors, acute disease, heart disease or severe hypertension. ◆ Need to be supervised. ◆ Women who are pregnant or menstruating. ◆ Those with osteoporosis, distorted joints, dysfunction or recent fracture. ◆ Those with serious or injured skin conditions. ◆ Those with high fever. ◆ The appliance has a heated surface. Persons insensitive to heat must be careful when using the appliance. (Need to be supervised) ◆ This appliance is not intended for use by persons (including children) with reduced physical, sensory or mental capabilities, or lack of experience and knowledge, unless they have been given supervision or instruction concerning use of the appliance by a person responsible for their safety. ◆ This appliance can be used by children aged from 8 years and above and persons with reduced physical, sensory or mental capabilities or lack of experience and knowledge if they have been given supervision or instruction concerning use of the appliance in a safe way and understand the hazards involved.
---	---

CONTROLLER PRECAUTIONS

 CAUTION	<ul style="list-style-type: none"> ◆ Do not operate the controller with wet hands or pull the controller wire by force. ◆ Do not spill water or other liquid into the controller to avoid fault. ◆ Do not lay heavy items on the controller.
---	---

CAUTIONS REGARDING THE POWER CONNECTORS AND POWER CORD





 CAUTION	<ul style="list-style-type: none"> ◆ The appliance is only to be used with the power supply unit provided with the appliance. ◆ It must only be supplied at safety extra low voltage corresponding to the marking on the appliance. ◆ Do not use a wet hand to unplug the AC cord to avoid electric shock. ◆ Do not pull on the power cord, reach to the front end to unplug it. ◆ Do not squeeze the power cord by heavy objects. ◆ Do not damage, over bend, pull hard or twist the power cord. ◆ If the supply cord is damaged, it must be replaced by the manufacturer or its service agent or a similarly qualified person in order to avoid a hazard.
---	--

SAFETY PRECAUTIONS

BEST CIRCUMSTANCES

 CAUTION	<ul style="list-style-type: none"> ◆ Do not use this appliance where temperature is over 40°C. ◆ Do not use this appliance in moist or dusty environment. ◆ Unplug from outlet during thunder or lightening storms. ◆ Do not use outdoors. ◆ Please place the product on the flat level floor. ◆ Do not store near heat or open flame.
---	--

BEST PRACTICES FOR SAFE USER

 CAUTION	<ul style="list-style-type: none"> ◆ Only for users weighs below 120kg. ◆ Do not use other therapeutic device together with this product. ◆ Use this product only for its intended use as described in this manual. ◆ Appliance should only be used by one person, do not use by two or more persons at the same time to avoid damage to the products. ◆ Do not use the product right after meal, it may cause discomfort. ◆ Remove the accessories from the arms and empty the pockets while use the massage services. ◆ Check the upholstery under the cushions and other spots, if any damages are present, do not use it and refer to a qualified service professional for servicing. ◆ If you feel any abnormal discomfort during the operation of this product, turn off the power immediately and do not use the product. ◆ Use the appliance for 20 minutes each time is highly recommended. ◆ Make sure there is no obstacles behind the chair and there is enough clearance before adjusting the backrest or footrest angle ◆ Make sure no other excessive load pressed on the backrest or footrest, keep children, pets or any other barrier away from the unit reclining backrest/extending footrest to prevent any accidental injury. ◆ Please be seated properly while using the appliance to avoid injury to the user or damage to the appliance. ◆ Do not drag or push the chair or roll on its casters on wood floor or carpet to avoid damage
 PROHIBITED	<ul style="list-style-type: none"> ◆ Never operate this product if it has damaged /exposed parts or power leakage. Do not stand on or stack heavy objects on the footrest. ◆ Children should be supervised to ensure that they do not play with the massage chair. Do not fall into sleep while the product is operating. ◆ Avoid using the product under the influence of alcohol. ◆ Do not put hands or foreign objects in the openings of the appliance to avoid injury to the user or damage to the appliance. ◆ If there is any smoke or unusual smell during operation, stop using immediately.
 NO DISASSEMBLE	<ul style="list-style-type: none"> ◆ Do not disassemble this product to avoid failure. ◆ Do not attempt to repair or dismantle the appliance without permission. ◆ Please contact authorized dealer or service agent.
 UNPLUG POWER CORD	<ul style="list-style-type: none"> ◆ Pull out the power cord from the power strips before maintenance. ◆ Never plug in or pull out power cord with wet hand to avoid shock or injury. Pull out the power cord from the power strips after use. ◆ Unplug from outlet when the power supply is cut.

NAME AND FUNCTION OF EACH COMPONENT

EXTERNAL STRUCTURE

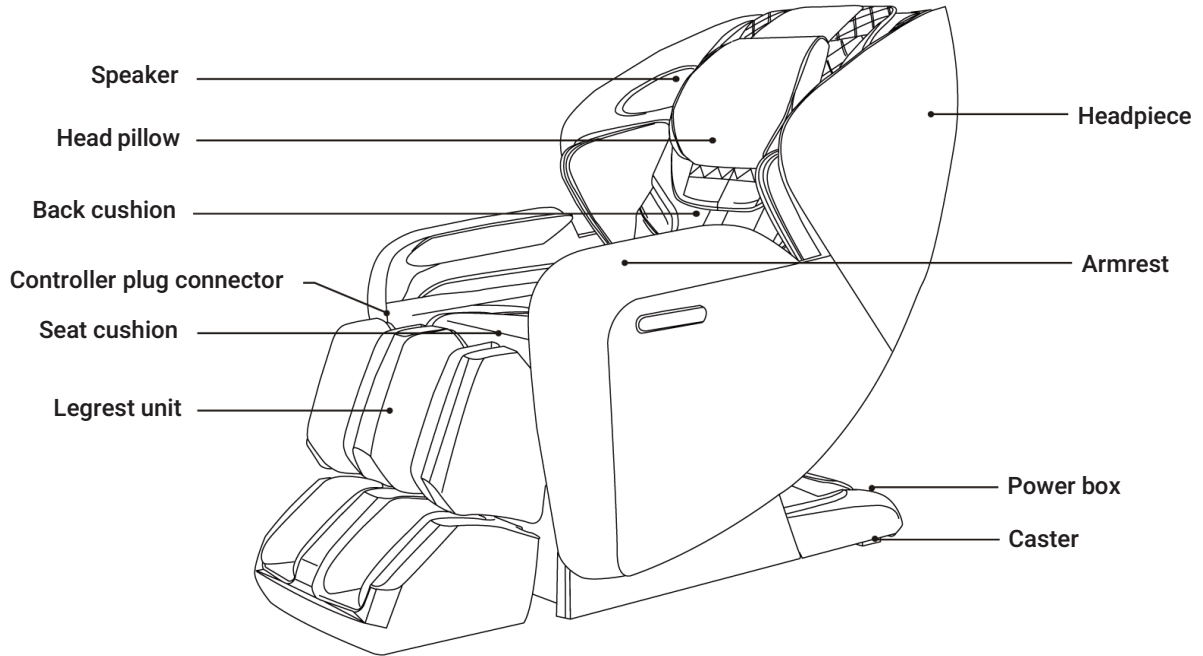

INTERNAL STRUCTURE

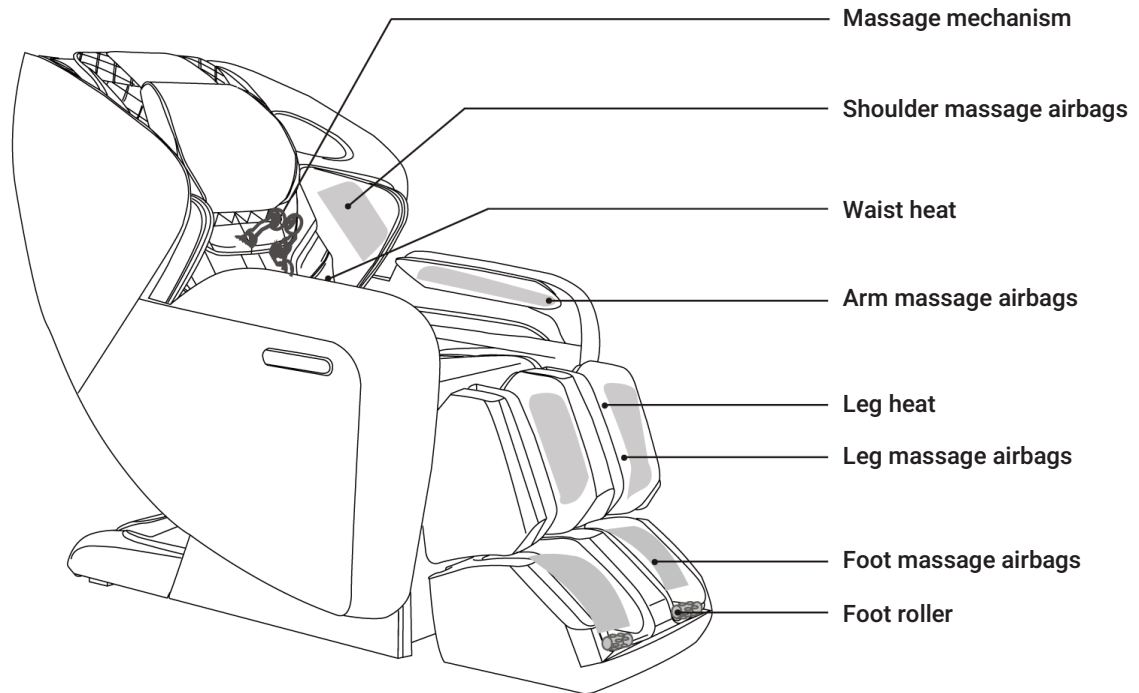

POWER BOX

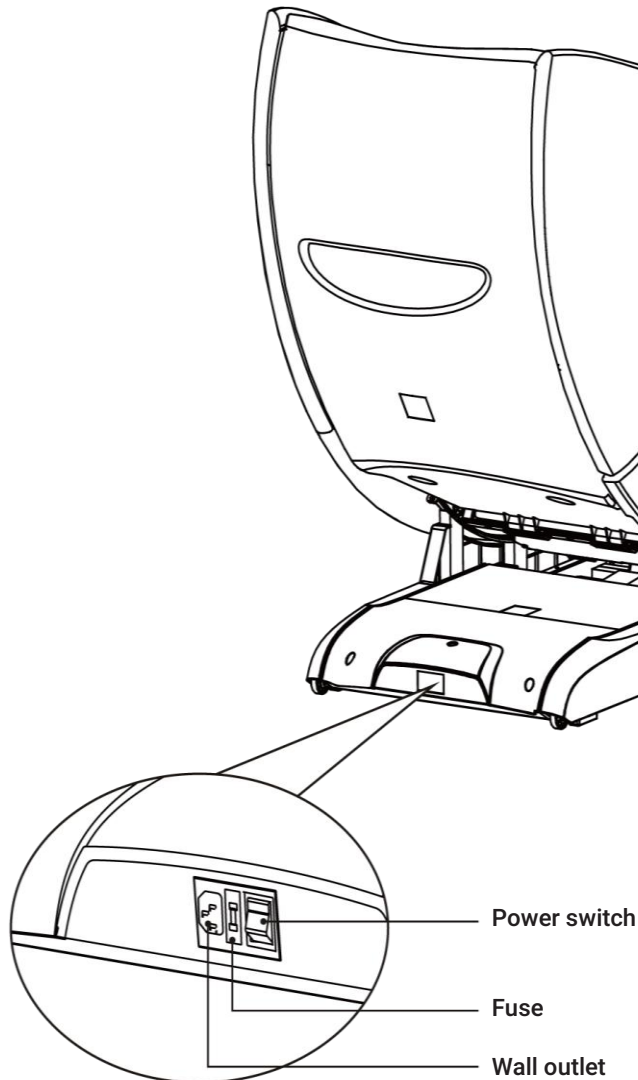

⚠ CAUTION

- ▶ Children should be supervised to ensure that they do not play with the chair or touch the power box.
- ▶ Always unplug the massage chair from the electrical outlet immediately after use.
- ▶ Unplug from outlet during thunder or lightening storms.
- ▶ Turn off the power switch and unplug the massage chair from the electrical outlet while not in use to avoid children power on the massage chair accidentally.
- ▶ When not in use for a long period of time, we recommend that the chair be covered, the power cord be coiled and that the unit be placed in an environment free of dust and moisture.

NAME AND FUNCTION OF EACH COMPONENT

CONTROLLER

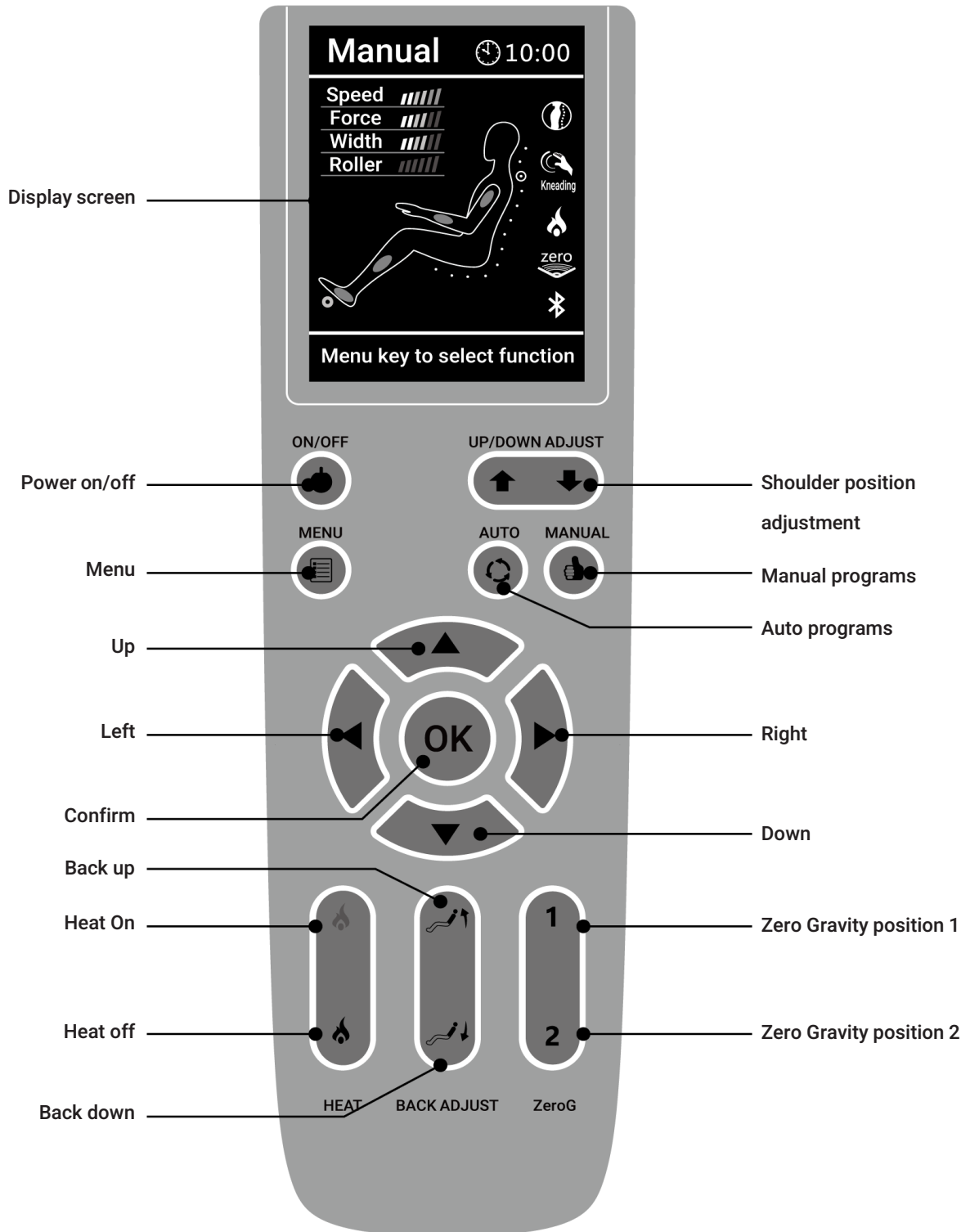

CONTROLLER INSTRUCTIONS



POWER ON/OFF PRESS THIS BUTTON TO POWER ON/OFF THE CONTROLLER.

- ▶ Press this button while connected to power to show the menu display, the LCDScreen is lit, use the UP/DOWN/LEFT/RIGHT buttons to navigate the screen, press OK to select.
- ▶ Press this button again to turn off the product.



MENU

- ▶ Display the Auto Program, Manual Program, Airbag, Heat, Roller and Settings function.
(Check the Display Menu for detailed information)



SHOULDER POSITION ADJUSTMENT BUTTON(MOVES MECHANISM UP AND DOWN)

- ▶ Press and hold Position UP/DOWN ADJUST button to adjust the rollers to the desired position while in Manual-Point massage mode.
- ▶ While body scanning is working, use these two buttons to slightly adjust mechanism up/down the shoulder.



AUTO PROGRAM BUTTON

- ▶ Press to start the pre-set auto massage programs. You can choose Extension, Re-fresh, Recovery, Relax, Neck&Shoulder, Waist&Buttocks massage programs according to your liking.
(Check the Display Menu for detailed information).



MANUAL PROGRAM BUTTON

- ▶ Display the manual mode menu, press UP or DOWN button to navigate among: Kneading, Knocking, Tapping, Shiatsu and Sync massage techniques.
(Check the Display Menu for detailed information)



NAVIGATION BUTTON

- ▶ Use the UP/DOWN/LEFT/RIGHT arrow buttons to navigate the screen, press OK to select.



HEAT ON

- ▶ Press to turn on heat, the heat icon will be lit on display screen;
- ▶ Press again to turn off heat, the heat icon will go dark on display screen;

▶ NAME AND FUNCTION OF EACH COMPONENT



BACK UP

- ▶ Press and hold to raise the backrest, release the button to stop.

BACK DOWN

- ▶ Press and hold to lower the backrest, release the button to stop.

1

ZERO GRAVITY POSITION 1

- ▶ Press Zero Gravity Position 1 to put the chair in Zero Gravity Position

1. press again to close the Zero Gravity Position 1; The Zero 1 icon will be lit on display screen accordingly.

2

ZERO GRAVITY POSITION 2

- ▶ Press Zero Gravity Position 2 to put the chair in Zero Gravity Position

2. press again to close the Zero Gravity Position 2; The Zero 2 icon will be lit on display screen accordingly.

DISPLAY SCREEN INSTRUCTIONS

AUTO MESSAGE PROGRAM

▶ Press to display the Auto Program menu, press this button to toggle among 6 Auto Programs:

EXTENSION, REFRESH, RECOVERY, RELAX, NECK & SHOULDER and WAIST & BUTTOCKS. The active program displays at the top of the status screen. (Check below Menu display photo for reference)

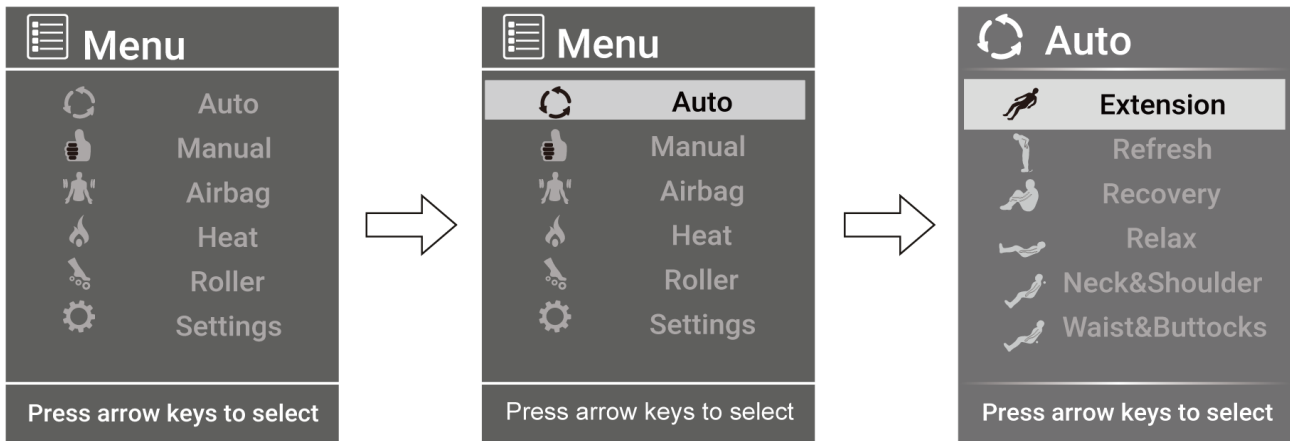

EXTENSION

Designed for people who experience body stiffness and muscle tension. It helps to relieve the body stiffness and improve your body flexibility.

REFRESH

Focusing on tight and sore muscles, it helps to relieve waist, back and neck pain.

RECOVERY

Recovery: Designed for after work recovery, it helps to release the fatigue and speed recovery.

RELAX

This message program is designed for morning or midday relaxing, it helps to de-stress, clear mind and increase productivity.

NECK & SHOULDER

Designed to help to ease the pain and stiffness in neck and shoulders, combined with curvature design of the backrest, this program targets the rollers at the deep tissue of neck and shoulders.

WAIST & BUTTOCKS

To relieve the pain of the lower back, this massage mainly focuses on the lumbar vertebra and the rollers will conduct targeted massage to relieve tension in this area.

NAME AND FUNCTION OF EACH COMPONENT

MANUAL PROGRAM

► Press MANUAL from MENU display, press UP or DOWN button to navigate among:-MODE,PART,WIDTH,SPEED and ZERO GRAVITY.

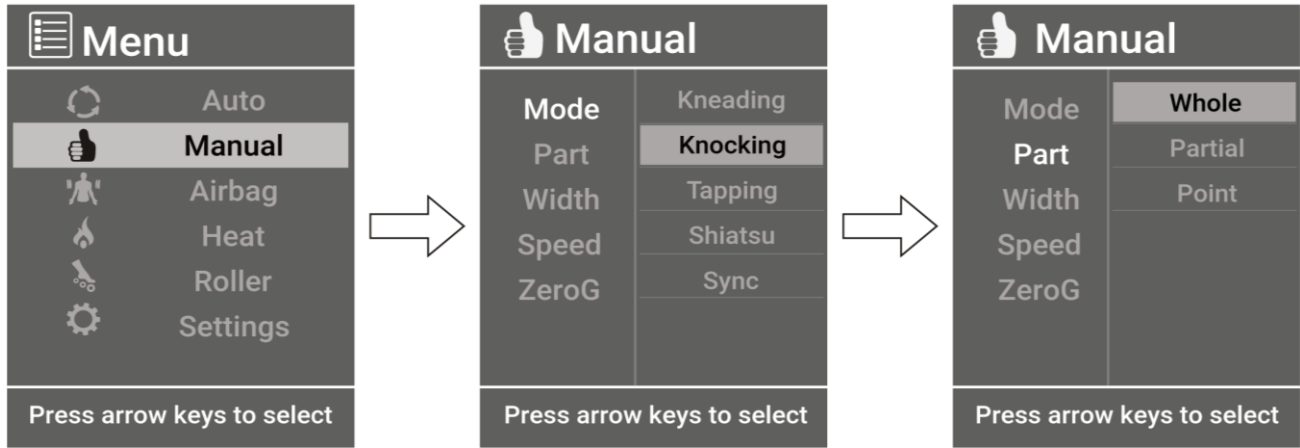

MESSAGE MODE:

Press MODE from MANUAL display, press RIGHT button then press UP or DOWN button to navigate among: Kneading, Knocking, Tapping, Shiatsu and Sync message techniques. Press OK button to enter the setting you desire. Selected mode will show on the home screen.

Back Mechanism Message Part: Press PART from MANUAL display, press Right button then press Up or Down button to navigate among: Whole, Partial and Point message regions. Press OK button to enter the setting you desire.

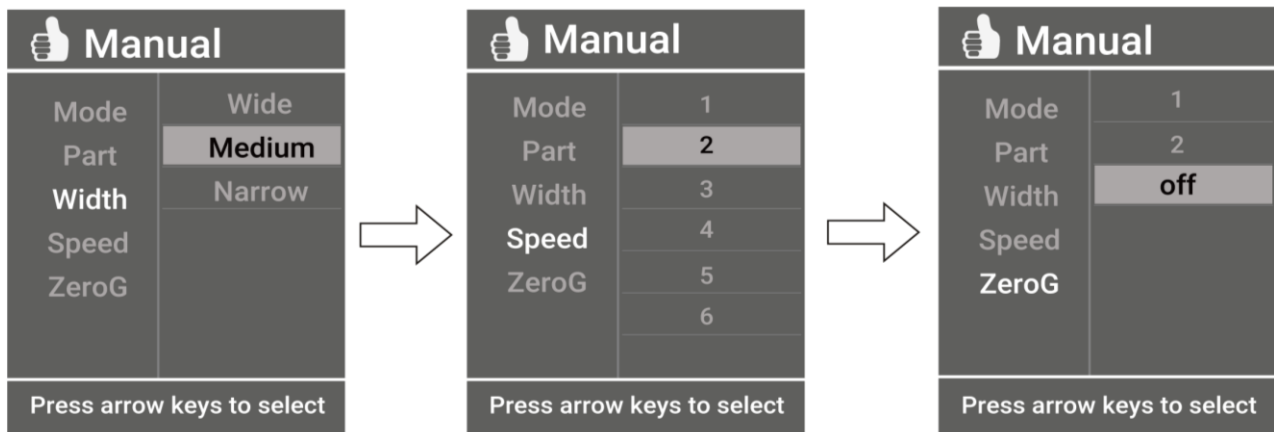

BACK MECHANISM MESSAGE WIDTH:

Press WIDTH from MANUAL display, press RIGHT button then press UP or DOWN button to navigate among: Wide, Medium and Narrow mechanism roller width. Press OK button to enter the setting you desire. Selected width will show on the home screen.(Not adjustable in manual mode-kneading/sync)

MECHANISM MESSAGE SPEED:

Press SPEED from MANUAL display, press RIGHT button then press UP or DOWN button to navigate among: level 1,2,3, 4,5,6 Mechanism message speed. Press OK button to enter the speed level you desire.(Not adjustable in Shiatsu mode)

ZERO GRAVITY POSITION

Press ZERO GRAVITY from MANUAL display, press RIGHT button then press UP or DOWN button to navigate among position 1, 2 or OFF (deactivate Zero Gravity). Press OK button to enter the setting you desire.

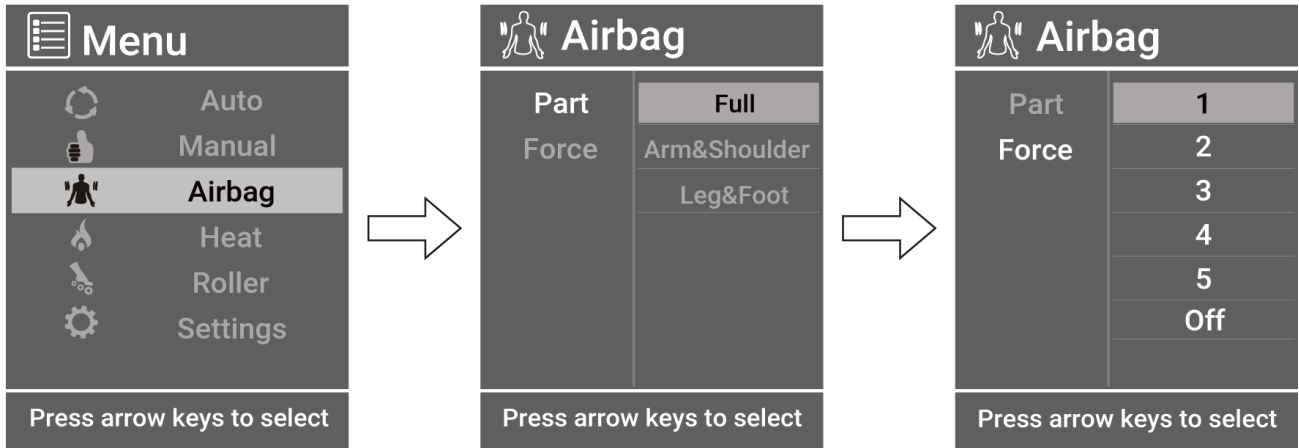

AIRBAGS

▶ Airbag: Press AIRBAG from MENU display to show the Airbag display, press RIGHT button then press UP or DOWN button to navigate between: Part-Air pressure region and Force-Air pressure intensity, Press OK button to enter the setting you desire.

PART-AIR PRESSURE REGION

Press PART from AIRBAG display, press RIGHT button then press UP or DOWN button to navigate among: Full, Arm & Shoulder, Leg & Foot positions. Press OK button to enter the airbag position you desire.

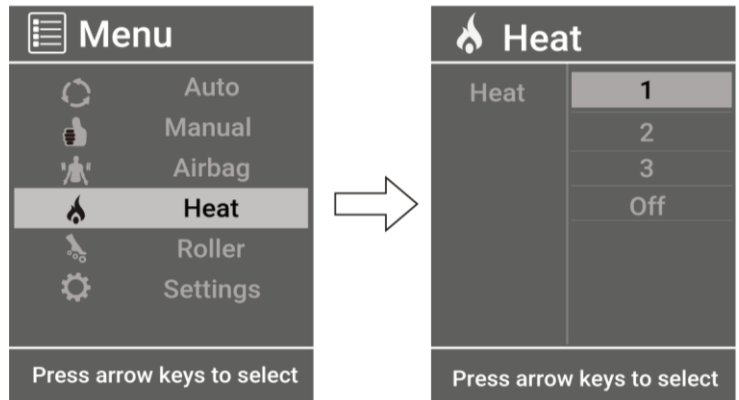

FORCE-AIR PRESSURE INTENSITY

Press FORCE from AIRBAG display, press RIGHT button then press UP or DOWN button to navigate among: 1, 2, 3, 4, 5 air pressure intensity, or Off (deactivate the airbag function). Press OK button to enter the airbag setting you desire.

HEAT

▶ Press HEAT from MENU display, press RIGHT then press UP or DOWN button to navigate among: heat level 1, 2, 3 or OFF (turn off heat). Press OK button to enter the heat setting you desire.

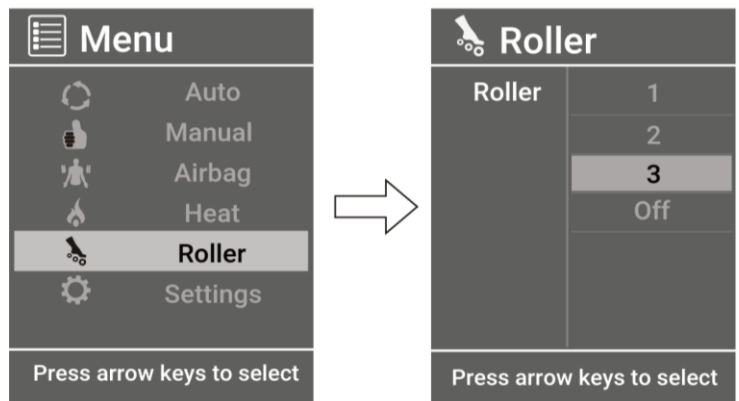

FOOT ROLLER

Press ROLLER from MENU display, press RIGHT button then press UP or DOWN button to navigate among: foot roller speed: level 1,2,3 or OFF (deactivate foot roller) .

Press OK button to enter the speed level you desire.

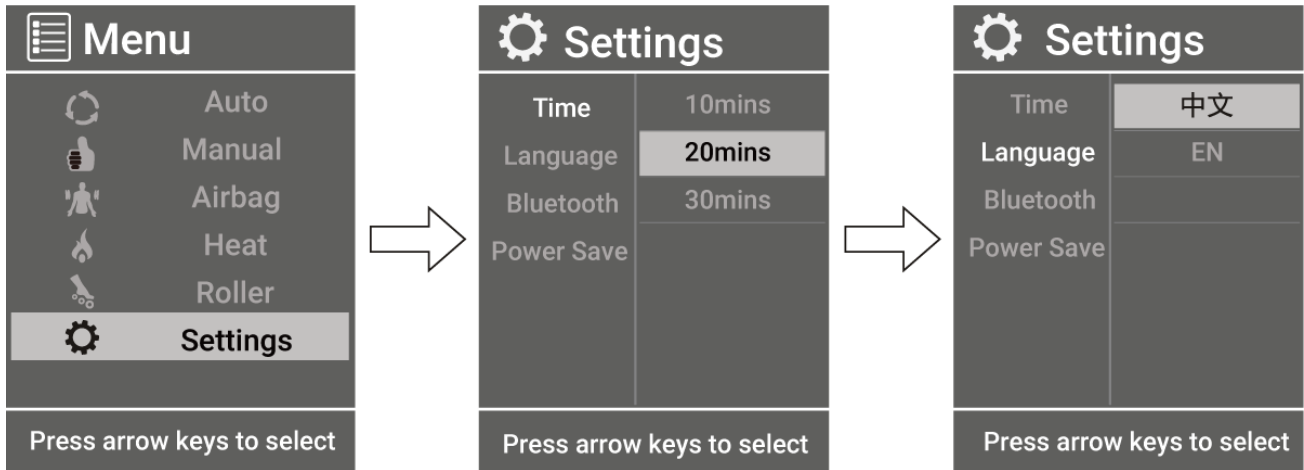

SETTINGS

► Press SETTINGS from MENU display, then press UP or DOWN button to navigate among: TIME, LANGUAGE, BLUETOOTH and POWER SAVE.

TIME

Press TIME from SETTINGS to show available timer: 10mins,20mins,30mins.press RIGHT button then press UP or DOWN button to navigate, press OK button to enter the timer you desire.

LANGUAGE

Press LANGUAGE from SETTINGS to show available language: 中文, EN. press RIGHT button then press UP or DOWN button to navigate, press OK button to enter the language you desire.

BLUETOOTH

Press BLUETOOTH from SETTINGS display, press RIGHT then press UP or DOWN button to turn On/Off Bluetooth,-Press OK button to enter the setting you desire.

POWER SAVE

Press POWER SAVE from SETTINGS display, press RIGHT then press UP or DOWN button to turn On/Off Power Save mode, Press OK button to enter the setting you desire.(In Power Save/Off mode, Bluetooth function is not available)

Please deactivate Power Save mode to turn on Bluetooth.

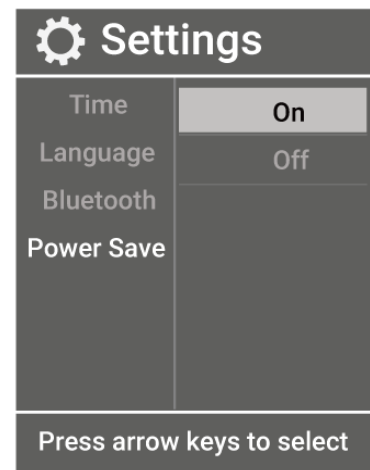
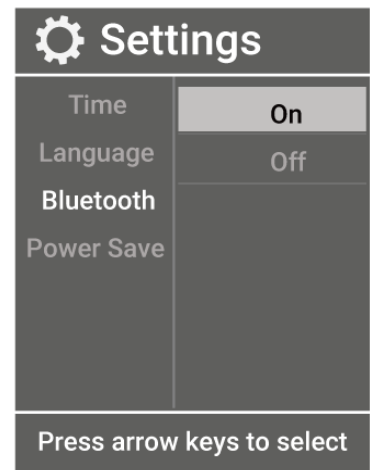

TIPS:

In the process of Auto or Manual Setting, LCD screen will auto revert back to the homescreen after 10 seconds if there is no operation entered into the controller.

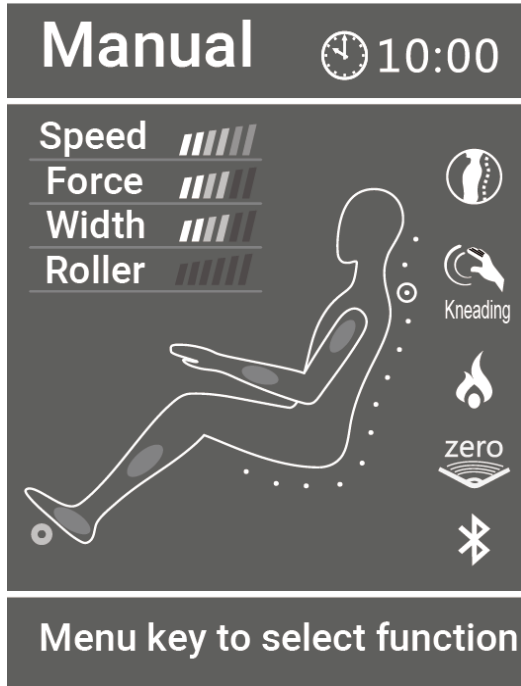

Homescreen display with the Manual program running

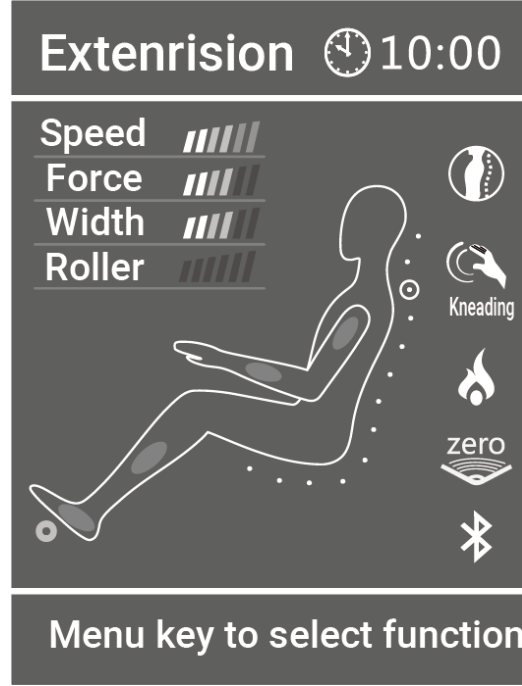

Homescreen display with the Auto program running

😊 **TIPS**

- ▶ While appliance is running, press twice MENU button to revert to homescreen.
- ▶ At the homescreen display, press LEFT or RIGHT button to adjust the airbag intensity(works in the process of both Auto and Manual program);press UP or DOWN button to adjust the massage intensity(only works in the process of Manual program)
- ▶ Press Auto button to select auto massage programs.



CAUTION

- ▶ Do not disassemble this product yourself to avoid product damage. Make sure no water or other liquid enters into the controller to avoid fault.
- ▶ Do not pinch or squeeze the controller or power cord.

POSITION & PLACEMENT FOR INSTALLATION

CLEARANCE SPACE FOR THE MASSAGE CHAIR:

- ▶ Ensure there is an adequate clearance for the installation: It needs 15 cm clearance for the reclining of the backrest; It needs 20 cm clearance space for the extension of footrest and sliding forward of the chair.
- ▶ Keep it 1 meter away from the TV, radio or other audio/video appliance to avoid signal interference.

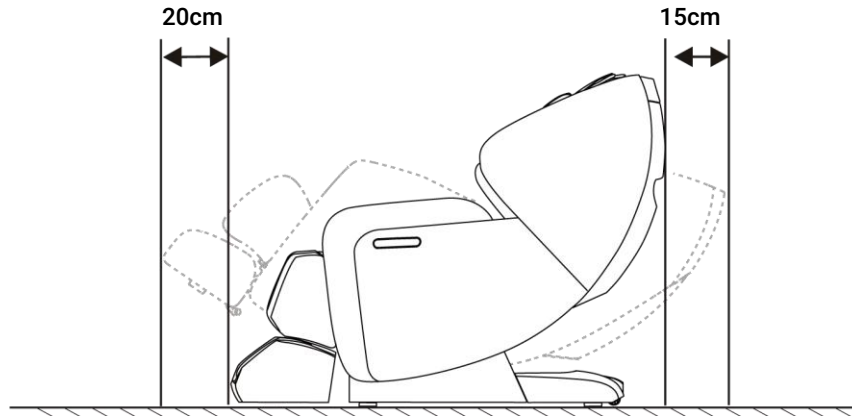

- ▶ Keep the distance between the power socket and power switch within 1.5 meter.

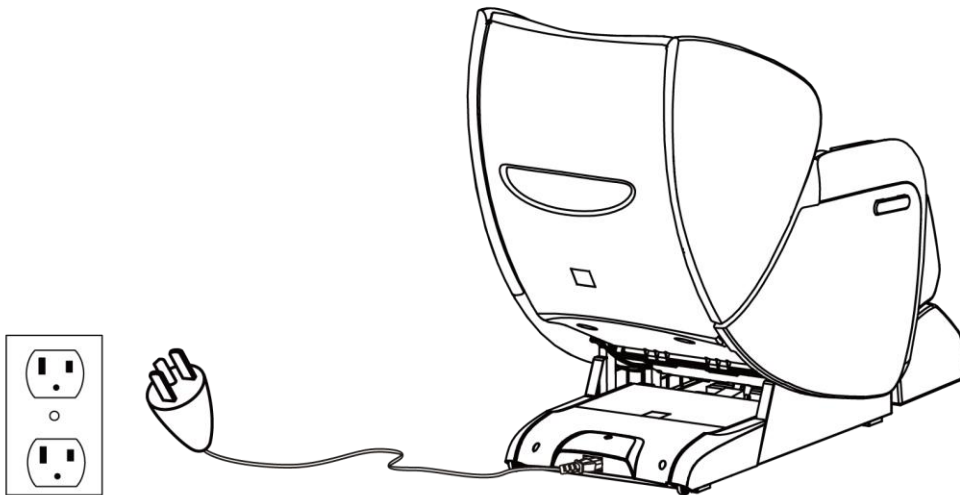

⚠ CAUTION

- ▶ Keep the distance between the power socket and power switch within 1.5 meter to avoid damage of power cord while massage chair sliding forward.
- ▶ Straighten the power cord while in use to avoid tangle or damage.
When the massage chair sliding forwards or back, please check to make sure there are no children, pets or other obstacles around to avoid accident.

PRELIMINARY CHECKS

FLOOR PROTECTION

► We recommend to place a piece of carpet or soft mat underneath it to avoid damaging the floor.

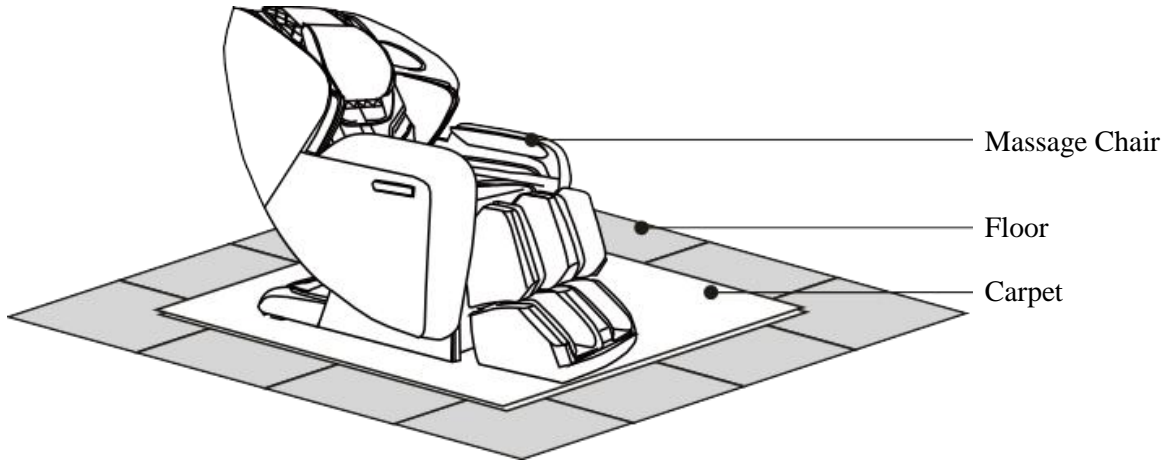

SURROUNDING ENVIRONMENT

Do not use the massage chair in high moisture environment such as near swimming pool or bathroom to prevent electric shock accident.

Please keep the massage chair away from heated surfaces to prevent fire hazard or damage to the product.



GROUNDING

This product must be grounded, the plug must be plugged into an appropriate 3-wire grounded outlet that is properly installed and grounded in accordance with all local codes and ordinances to reduce risk of electrical shock.

PRELIMINARY CHECKS

INSTALLATION METHOD

STEP 1, TAKE ALL MASSAGE CHAIR UNITS OUT OF THE CARTONS

Unpack the cartons and take out all sewing and other accessories out of the cartons. Before beginning installation, please verify that all components are included(check with the packing list carefully)

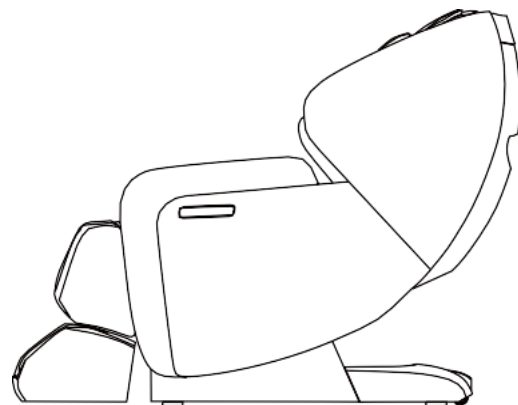

PRELIMINARY CHECKS

STEP 2, INSTALL THE CONTROLLER

- ▶ Connect the controller cable to the massage chair's plug connector (line up the pins with the port before connection).

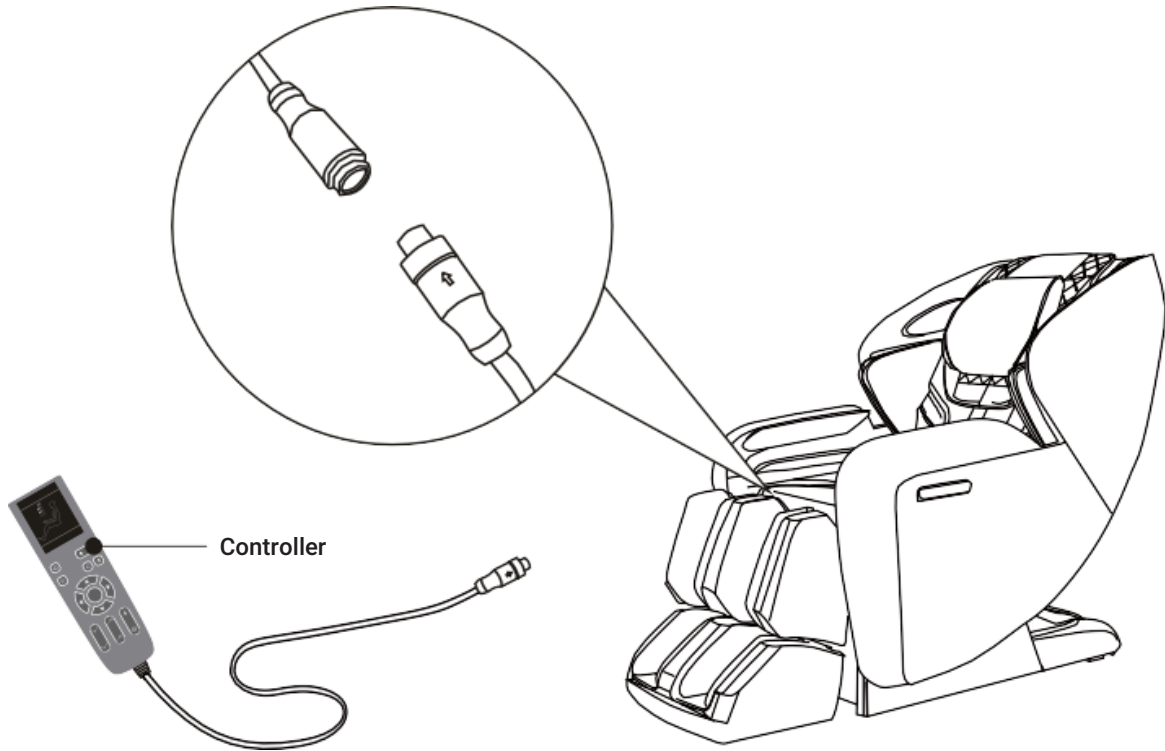

- ▶ Connect the power cable to the product power connector port.

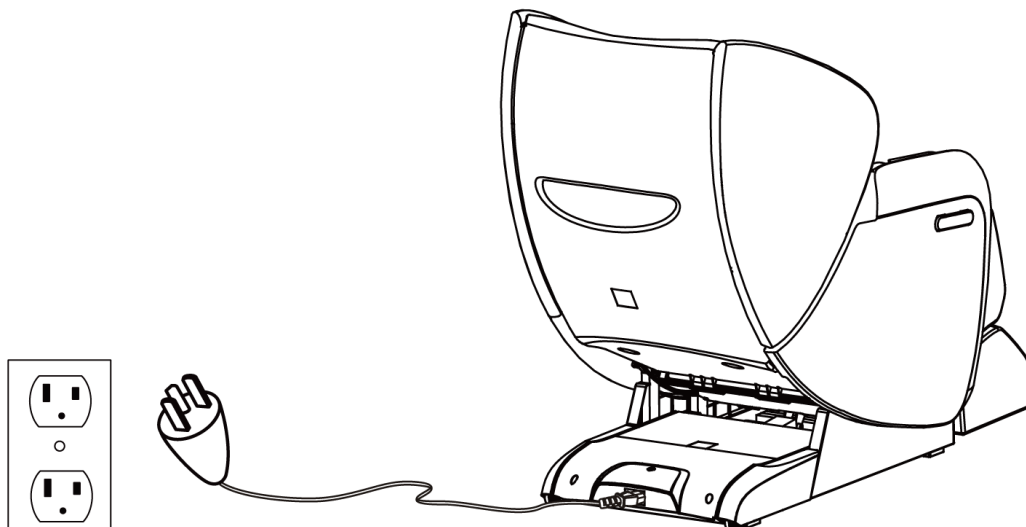

PRELIMINARY CHECKS

MOVING THE MASSAGE CHAIR

- ▶ Roll the chair on its casters to the desired location.
- ▶ Incline the backrest to upright position.
- ▶ Turn off the power switch and unplug the appliance from the electrical outlet.
- ▶ Using two people, push down on the backrest and lift up on the front side by grabbing the moving Holder located to the front bottom of the armrest),roll the chair on its casters to the desired location(check the sketch for reference).

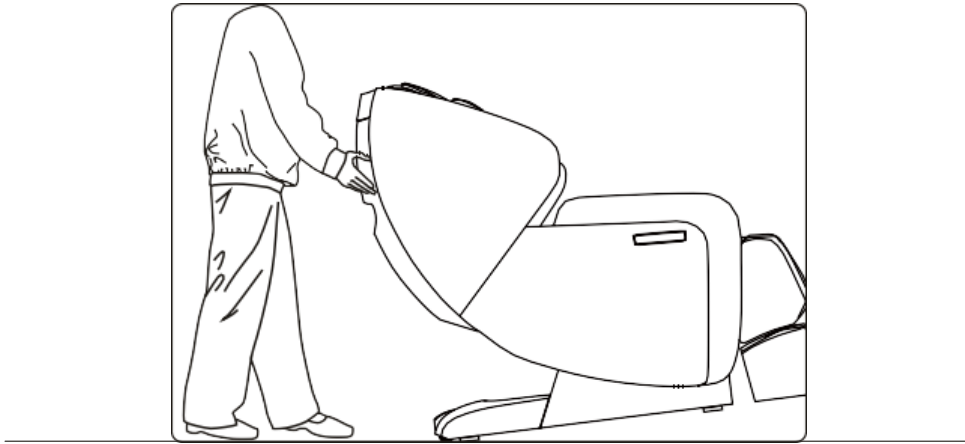

CAUTION

- ▶ Do not move the chair when there is user inside.
- ▶ To carry this product, do not lift by the footrest or armrest, hold the chassis and steady the backrest(have 4 or more people to carry the product).

CONNECTING TO POWER

- ▶ Connect this appliance to a 3-wire properly grounded outlet.
- ▶ Turn on the main power switch by the right hand side of the massage chair.

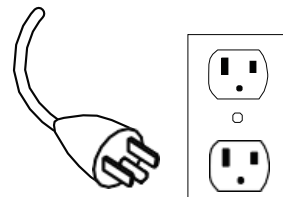

CAUTION

- ▶ Please verify that there is no damage to the supply cord before switching on the massage chair.
- ▶ Please verify that the main power switch is turned off before connecting to power.

COMMISSIONING

- ▶ Use the controller to recline the backrest to its lowest position, raise and extend the footrest to its top position, make sure there is enough clearance before commissioning.
- ▶ Return the backrest and footrest back to its default position after commissioning and turn off the power switch. To choose the massage program, please check the Instructions of Control Panel and Instructions of Touchscreen Controller for reference.

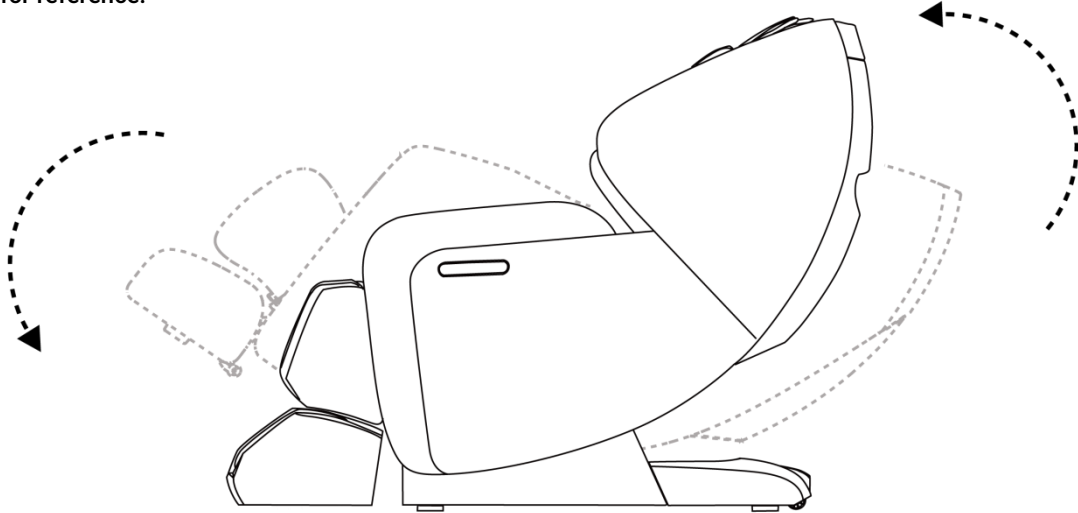

BEFORE SITTING IN THE CHAIR

- ▶ Ensure the footrest is well assembled before sitting on the massage chair.
- ▶ Ensure the massage chair is returned to its original position before sitting on it.
- ▶ If there is any part not in default position, please turn off the massage chair to allow it to restore.



CAUTION

- ▶ Do not take seat while the legrest is lifted.
- ▶ Do not put excessive load on the legrest to avoid damage.

AFTER USE

- ▶ Always unplug the massage chair from the electrical outlet immediately after use.
- ▶ Put the Touchscreen Controller onto the holder.
- ▶ Turn off the power switch and unplug the massage chair from the electrical outlet while not in use to avoid children power on the massage chair accidentally.
- ▶ When not in use for a long period of time, we recommend that the chair be covered, the power cord be coiled and that the unit be placed in an environment free of dust and moisture.

CARE INSTRUCTIONS

- ▶ To treat stains on back panel, armrest, footrest, plastic parts or air hose, spot clean with mild detergent foam, then wipe it with a dry cleaning cloth.
- ▶ To treat stains on controller, power box, spot clean with a dry cleaning cloth.
- ▶ To treat stains on back cushion or pillows, use a water-based upholstery cleaner only, wipe it with moist cloth, then air dry.
- ▶ To clean the foot/calf unit covers, remove it from the chair, hand wash with a mild detergent, then line dry.



WARNING

- ▶ Children shall not play with the appliance. Cleaning and user maintenance shall not be made by children without supervision.
- ▶ Pull out the power cord from the power strips before care and maintenance.
- ▶ To avoid electrical shock or injury, do not touch the power cord with wet hands.
- ▶ Make sure no detergent enter into the power box while cleaning.
- ▶ Do not use benzene, thinner or other solvents on your product, it may cause fading or damage to the product.
- ▶ Do not iron the upholstery.

STORAGE METHODS

- ▶ Cover the product with a dust-free cloth to prevent collection of dust if not in use of a long period of time.



CAUTION

- ▶ Do not leave this product exposed to direct sunlight for long periods of time. This may cause fading or damage.

WARM TIPS

During daily use, please check for the following symptoms:

- ▶ Burnt smell.
- ▶ Power flickers on and off when touching the charging cable.
- ▶ The power cord is hot.
- ▶ Other abnormal symptoms.



CAUTION

- ▶ Please stop using the product to avoid breakdowns or accidents if any above symptom exists. Switch off the power button and disconnect the plug , contact the local distributors or supplier for repair.
- ▶ All other servicing except above care and maintenance should be serviced by an authorized dealer or service center.



WARNING

- ▶ Pull out the power cord from the power strips before care and maintenance.
- ▶ To avoid electrical shock or injury, do not touch the power cord with wet hands.
- ▶ Do not try to dismantle or repair the product yourself, please send your massage chair to the authorized service center.

**TROUBLESHOOTING**

NO.	SYMPTOMS	POSSIBLE CAUSES	POSSIBLE SOLUTIONS
1	Noise is heard while in use	This sound is normal and comes from the air pump motor or other mechanical parts rubbing against the cloth cover	No need to take any measures
2	Appliance does not start	The power cord is not secured into the socket	Insert the power plug properly into the power socket
		Power switch is off	Turn on the switch
		The fuse is blown	Replace only with a fuse of same type and rating
3	No music comes from the speaker	The volume is turned to the lowest	Adjust the speaker volume from the mobile devices
		Bluetooth is off	Switch on Bluetooth
		Bluetooth connected with other device	Reconnect Bluetooth
4	Backrest or footrest cannot raise or recline	Excessive load has been pressed on the backrest or legrest	Reduce the load and try again
5	Airbag malfunction	The air hose is blocked	Straighten the air hose and clear out the blockage

If problem remains, please contact the dealer for maintenance.

Important: Do not attempt to repair this product yourself, our company shall not be liable for the injury or damage caused by any servicing without authorization.

▶ TECHNICAL SPECIFICATIONS

NAME: MASSAGE CHAIR

MODEL: RT6891

RATED VOLTAGE: 110-120V~

RATED CURRENT: 1.0 A

RATED FREQUENCY:60HZ

This product must be grounded. If it should malfunction or breakdown, grounding provides a path of least resistance for electric current to reduce the risk of electric shock. This product is equipped with a cord having an equipment-grounding conductor and a grounding plug. The plug must be plugged into an appropriate outlet that is properly installed and grounded in accordance with all local codes and ordinances.

DANGER – Improper connection of the equipment-grounding conductor can result in a risk of electric shock. Check with a qualified electrician or serviceman if you are in doubt as to whether the product is properly grounded. Do not modify the plug provided with the product—if it will not fit the outlet, have a proper outlet installed by a qualified electrician.

This product is for use on a nominal 120 V circuit and has a grounding plug that looks like the plug illustrated in sketch A in following figure. Make sure that the product is connected to an outlet having the same configuration as the plug. No adapter should be used with this product.

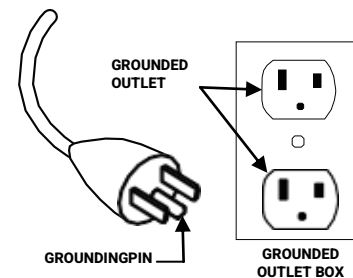

EARTHING

This massage chair belongs to Level One electrical appliance, make sure to use three-core power supply socket and to guarantee the ground wire connected to the power supply socket has obtained good ground connection to avoid electric leakage, electric shock and some other negative effect during use

WARRANTY INFORMATION:

Please refer to our website for detailed warranty conditions and coverage.
For the most up-to-date and comprehensive warranty information, visit www.tmgindustrial.com