

MODEL TMG-GHD3060

30 x 60 FT LIGHT DEPRIVATION TUNNEL GREENHOUSE

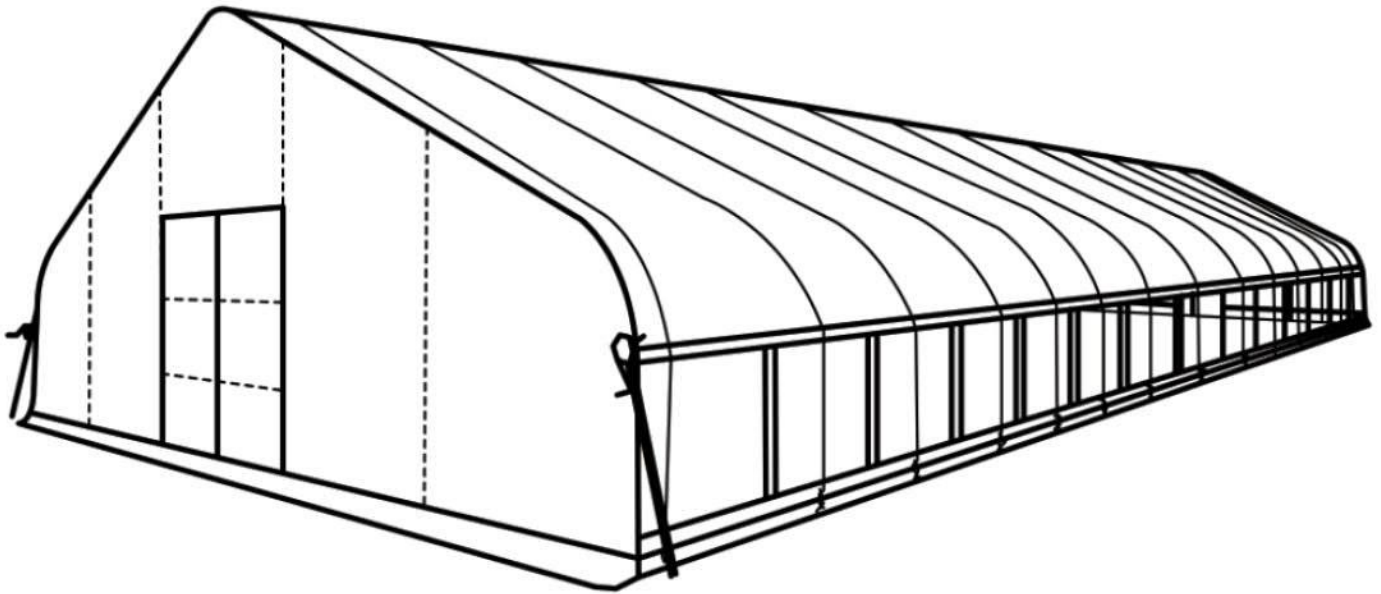

⚠ WARNING



- Please read and understand the product manual completely before assembly
- Check against the parts list to make sure all parts are received
- Wear proper safety goggles or other protective gears while in assembly
- Do not return the product to dealer. They are not equipped to handle your requests.

Missing parts or have questions on assembly?

Please call: 1-877-761-2819 or email: cs@tmgindustrial.com

Main specifications

- Assembly size : W9.15 x L18.2 x H3.66 (m) / W30 x L60 x H12 (ft)
- Shoulder height : H1.6 (m) / 5ft
- Door : W2.2 x H2 (m) / 7.2 x 6.6 (ft)

Prior to assembly

Please read the instructions carefully before installation. It is important to follow your local safety regulations and industry standards during installation. Regulations may include but are not limited to :

- Safety helmets, protective eyewear, and clothing
- Safety harnesses for all elevated workers
- Proper ladder, cage, and safety operation

Check all components and parts before installation. All parts are marked with a part number, please refer to the parts list to make sure you have all parts.















Choose a day with low or no wind to install, assembly is hard in heavy wind. Do not make any alterations to the structure. Do not hang any weights on the frame during installation, including parts. We are not responsible for any damages or injuries caused by inappropriate installation, unauthorized modifications or extreme weather.



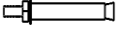



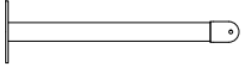









This building is not intended for human occupancy.

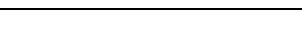
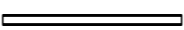











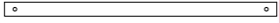

It is recommended to tape or add foam/rubber on the frame where joints connect and where it touches the cover. This will help extend the life span of the cover.











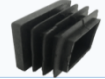

Read the following item list carefully and count the number of items to ensure that all parts are included prior to setup.

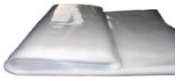
TMG-GHD3060 Part List

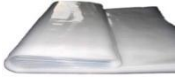
Part code	Graphical	Description	Length	Qty
1		Peak arch tube	φ58xL1370mm	15
2		Upper rafter tube	φ58xL1780mm	26
2A		Upper rafter tube (front and rear trusses)	φ58xL1780mm	4
3		Lower rafter tube	φ58xL1990mm	26
3A		Lower rafter tube (front and rear trusses)	φ58xL1990mm	4
4		Shoulder tube	φ58xL1956mm	26
4A		Shoulder tube (front and rear trusses)	φ58xL1956mm	4
5		Roof purlin (horizontal tube)	φ42xL1340mm	98
6		Base plate	L150mm	30
6A		Expansion bolt	φ14x100mm	110
7		Base plate	L150mm	8
8		Vertical tubes	L1487mm	4
8A		Vertical tubes	L872mm	4
9		Tubes support	L570mm	2
9L		Door left lower vertical tubes	L1487mm	2
9A		Door left upper vertical tubes	L1682mm	2

9R		Door right lower vertical tubes	L1487mm	2
9B		Door right upper vertical tubes	L1682mm	2
9C		Connector tube	L120mm	8
10		Door cross tubes	φ42xL1552mm	4
10A		Door cross tubes	L1689mm	4
10B		Door frame cross pull tube	L2154mm	2
11		Ceiling cross bar	φ42xL1987mm	13
12		Door frame column tube	L1978mm	4
12L		Door frame column left tube	L1978mm	2
12R		Door frame column right tube	L1978mm	2
13		Door horizontal tube	L990mm	16
14		Reed groove	L2000mm	97
14A		Clip spring	L2000mm	100
14B		Connecting piece	L95mm	8
15		Film rolling machine guide tube	φ25xL1430mm	2
15A		Film rolling machine guide tube	φ25xL1650mm	2
15B		Film rolling machine guide tube	φ25xL1993mm	2
16		Roll film tube	L1993mm	18

16A		Roll film tube	φ25xL820mm	2
16B		Roll film tube	L1995mm	18
16C		Roll film tube	L550mm	2
16D		Connecting rod	L100mm	18
17		Door buckle	L150mm	8
18		Film rolling machine	L220mm	2
18A		Film rolling machine	L200mm	2
19		Eight clip spring	L120mm	28
20		Pressure film carrier	L80mm	60
21		Half round head bolt	M6x50mm	32
22		Self locking bolt and nuts	M10x80mm	105
23		Self locking bolt and nuts	M8x70mm	240
24		Hex bolt and nuts	M10x70mm	32
25		Hex bolt and nuts	M10x30mm	38
26		Hex bolt and nuts	M10x120mm	2
26A		Hex bolt and nuts	M8x80mm	2
26B		Hex bolt and nuts	M6x35mm	4
27		Self tapping screw	#12x25mm	543

27A		Half round head bolt	M6x12mm	36
28		Self tapping screw	#12x35mm	144
29		Square plug	W30mm	16
30		Round plug	φ25mm	12
31		Braided rope	φ8xL200m	1
32		Top cover film	W14.5xL19m	1
32A		Front and rear door film(black and white film)	W4.5xL9.5m	2
32B		Top cover film (black and white film)	W7.3xL19m	2
33		Adhesive tape	(10m)	10
34		Socket wrench	(8mm)	1
35		Hex wrench	(4mm)	1
35A		Hex wrench	(5mm)	1
36		Board (not included)	150x15x2000mm	44

Installation steps

Step 1 : Review the whole structure and choose the proper installation site.

Mark the ground in the final building location with a line showing the positions of base plates, front doors. All lines should be drawn from center to center of all base plate tubes. Diagonal line X must be equal to Y.

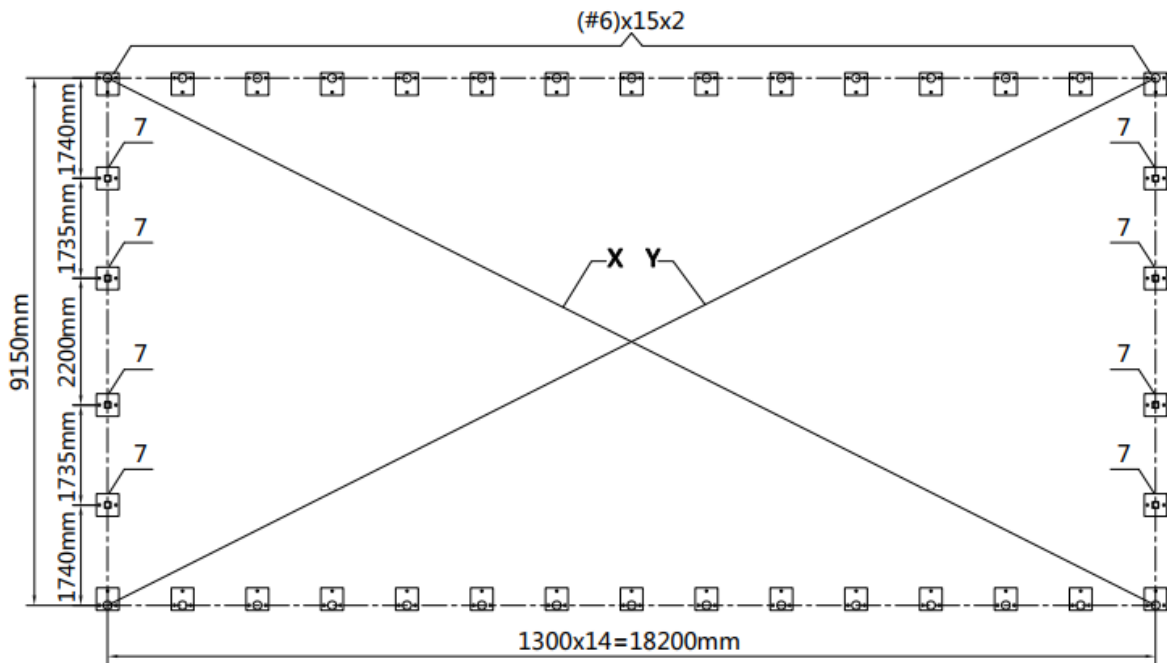

- Installation diagram of expansion bolt.

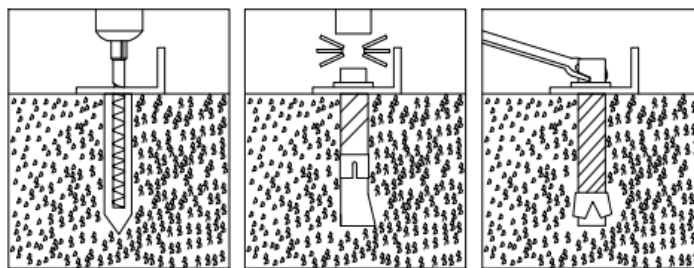



No.	Part	Qty
6		30
6A		106

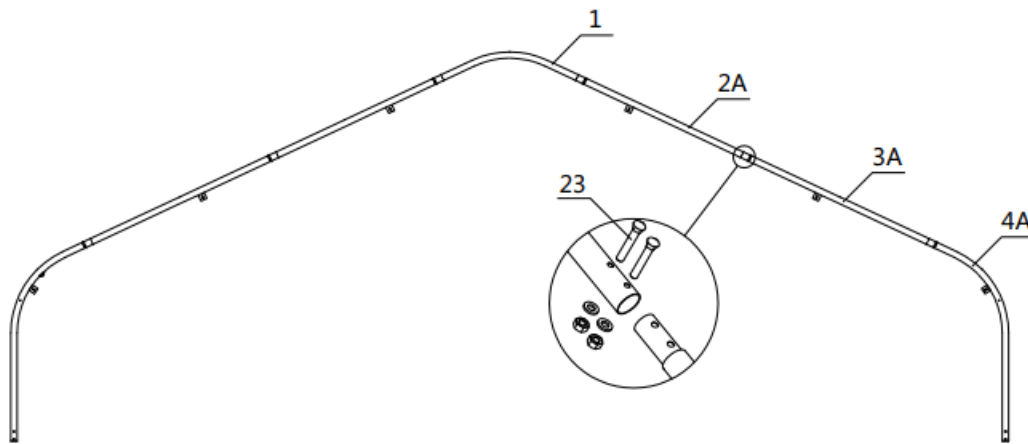

No.	Part	Qty
7		8

Step 2 : Assemble all trusses.

- Install front and rear trusses.

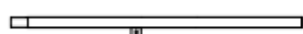





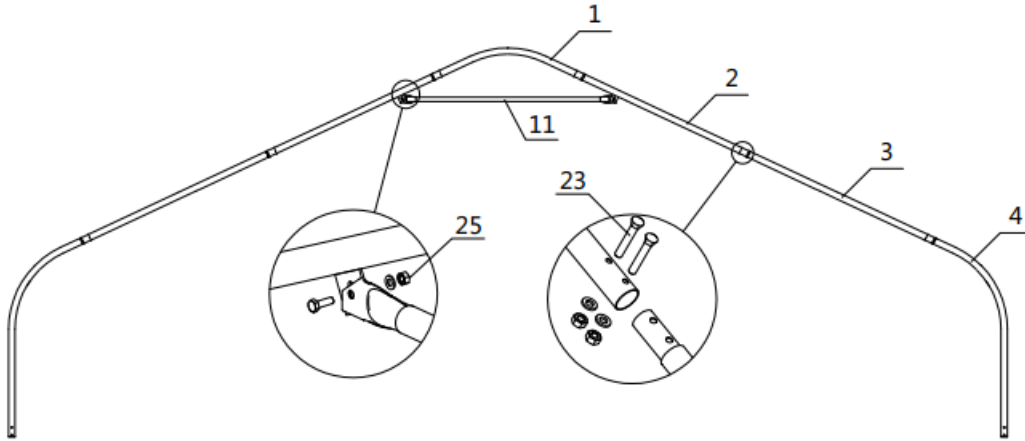

No.	Part	Qty
1		1x2
2A		2x2
3A		2x2

No.	Part	Qty
4A		2x2
23		12x2

- Install (13) middle trusses.

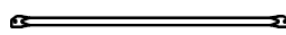

No.	Part	Qty
1		1x13
2		2x13
3		2x13
4		2x13

No.	Part	Qty
11		1x13
23		12x13
25		2x13

- Lay down all (15) trusses on the ground when the assembly is all completed and before moving to next step, and then wrap (#33) around the sharp points of the joint to avoid friction between the fabric and the interface, resulting in fabric damage.

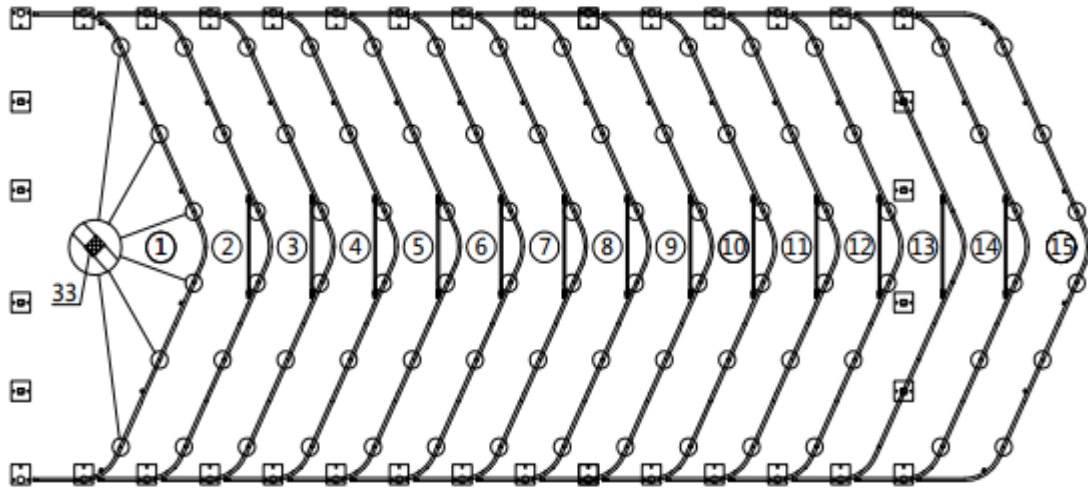

No.	Part	Qty
33		4



Step 3 : Put up all trusses.

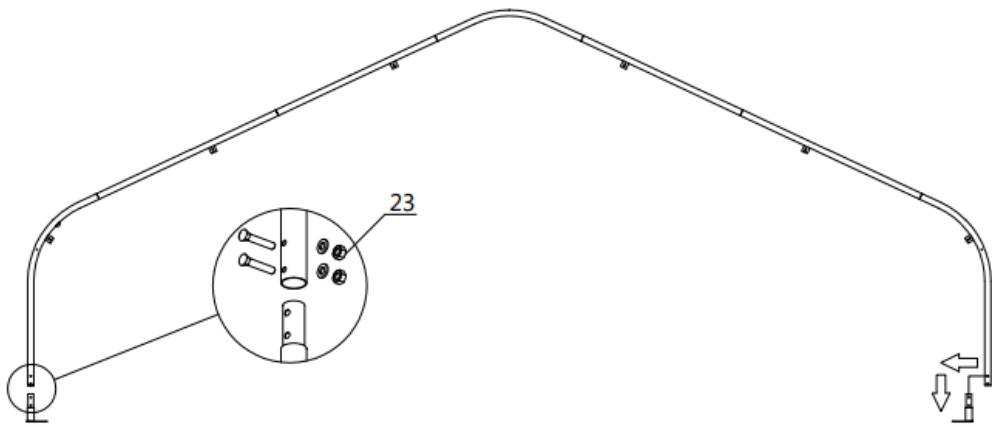

- Put up the truss, use hex bolt (#23) to secure the truss to the base plates.

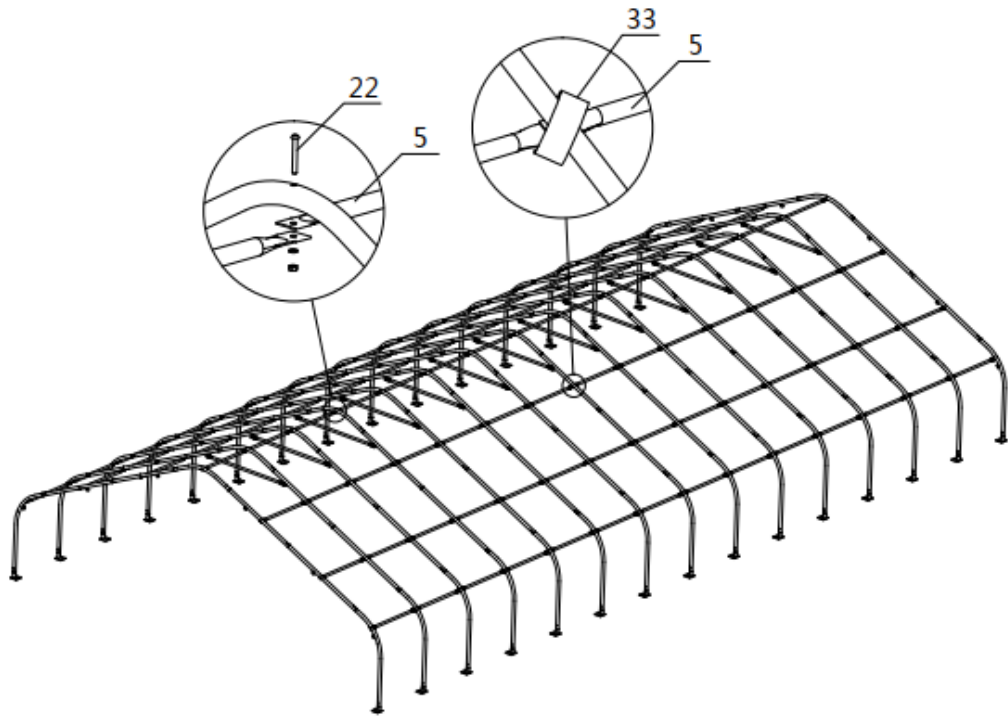

- Connect all purlins, and then wrap (#33) around the sharp points.



No.	Part	Qty
5		98
22		105

No.	Part	Qty
23		60
33		6

Step 4 : Install front and rear trusses.

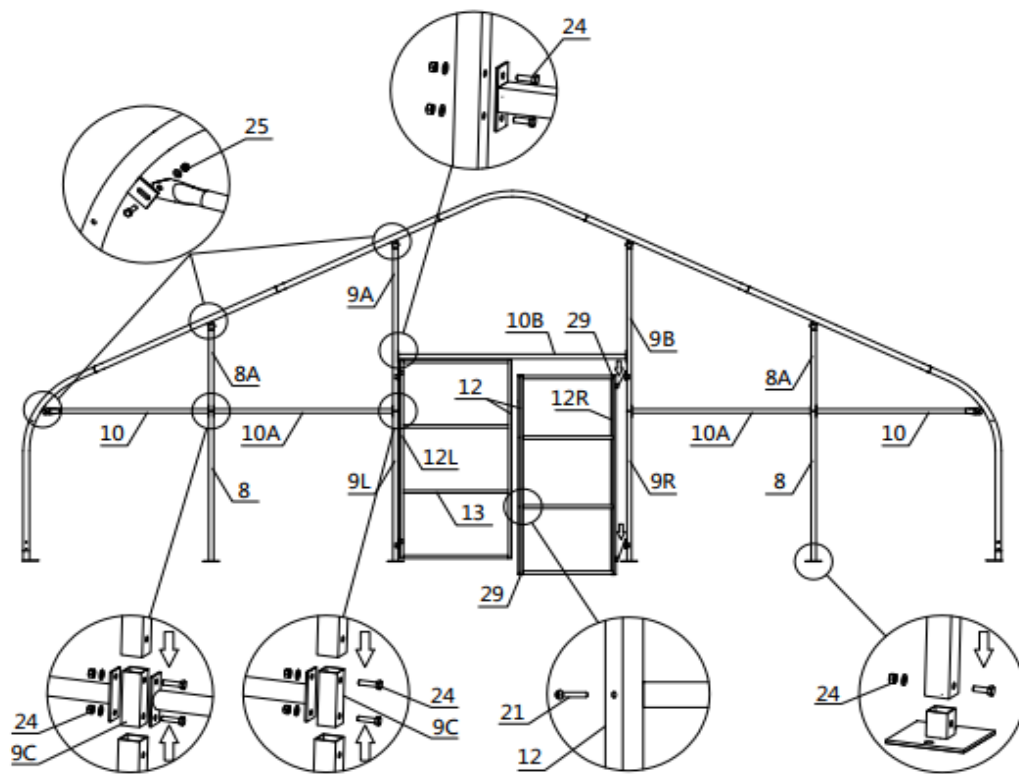



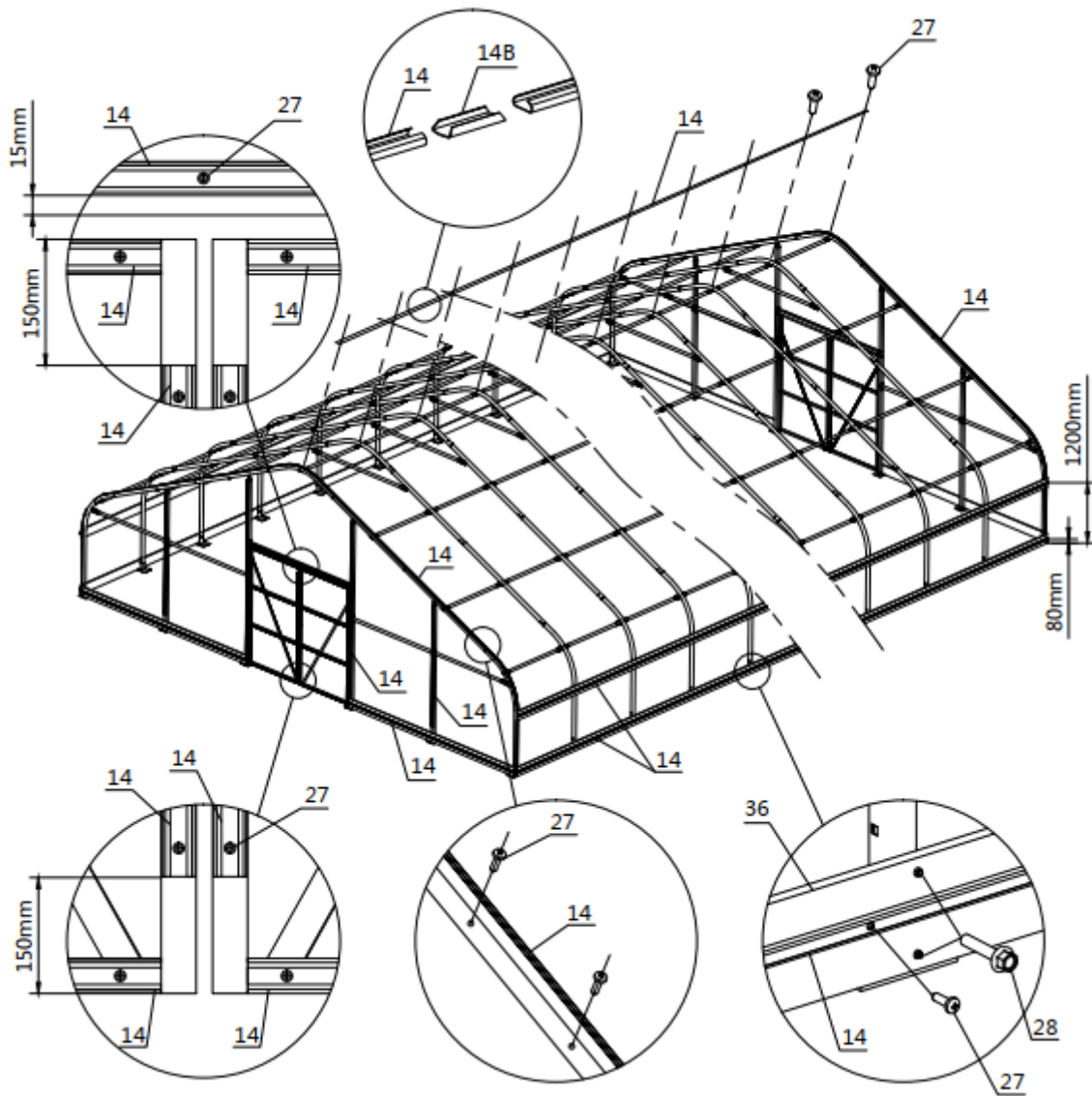

No.	Part	Qty
8		2x2
8A		2x2
9L		1x2
9R		1x2
9A		1x2
9B		1x2
9C		4x2
10		2x2
10A		2x2

No.	Part	Qty
10B		1x2
12		2x2
12L		1x2
12R		1x2
13		8x2
21		16x2
24		16x2
25		6x2
29		8x2

Step 5 : Install boards (#36) and reed groove (#14).



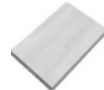

No.	Part	Qty
14		97
14B		8
27		455

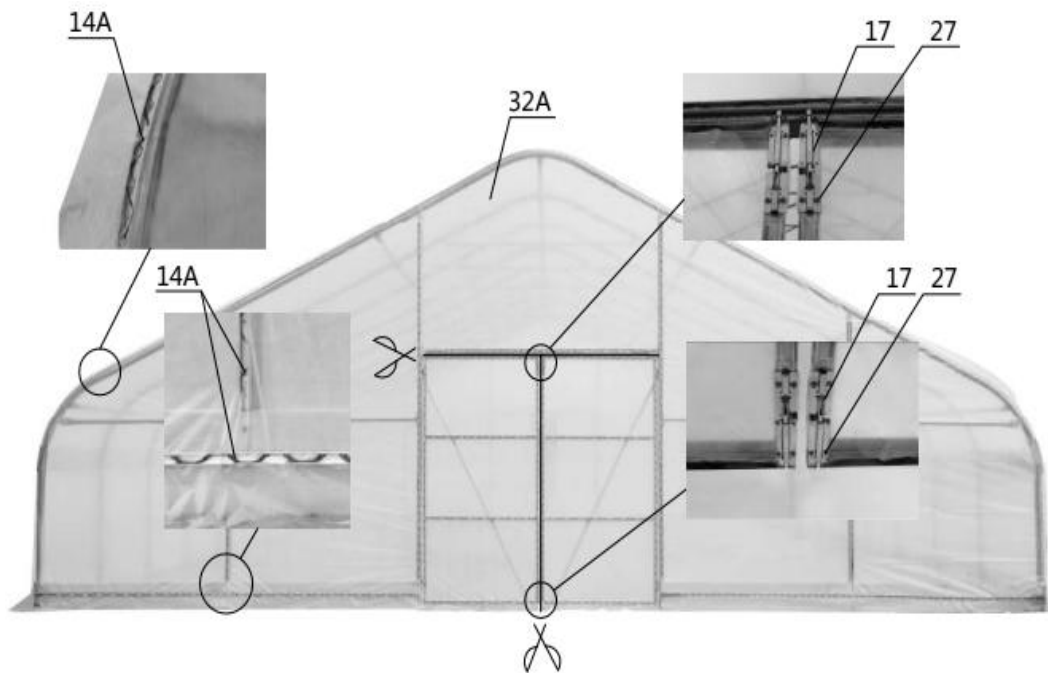

No.	Part	Qty
28		144
36		44

Step 6 : Install front and rear film.

- Lift the film (#32A) and fix the film with a clip spring (#14A) from top to bottom.
- Cut the door film as shown.





No.	Part	Qty
14A		24x2
17		4x2

No.	Part	Qty
27		24x2
32A		1x2

Step 7: Install top cover film.

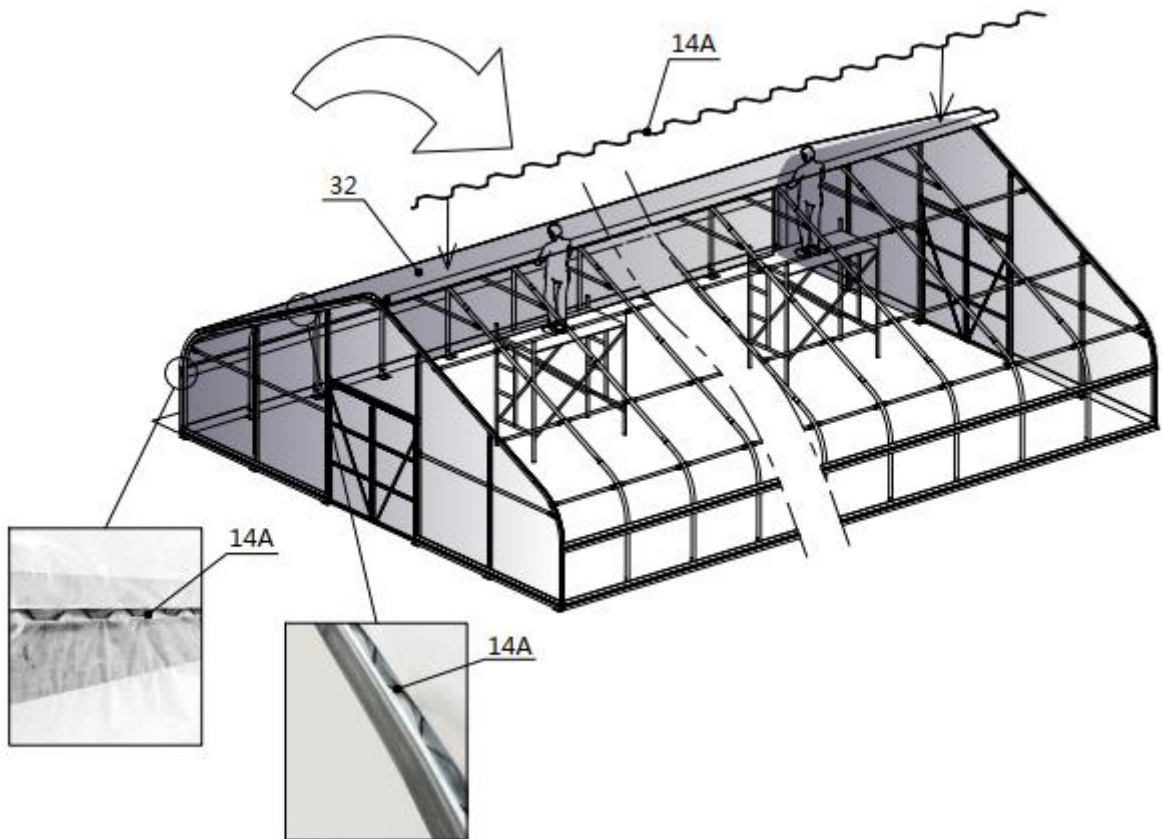
- When you are ready to install the roof cover, unpack the cover and position it parallel to the building frame on one side. the cover must be pulled over the top of the truss frame without being snagged or stressed on any frame members. tighten the film evenly to eliminate wrinkles and make the film flat and smooth. Do not over-tighten during the adjustment process, otherwise it will cause unnecessary damage. At this time, you can install a clip spring (#14A) to fix the film.
- Install inner film.



No.	Part	Qty
14A		26
32		1

- Install black and white film.

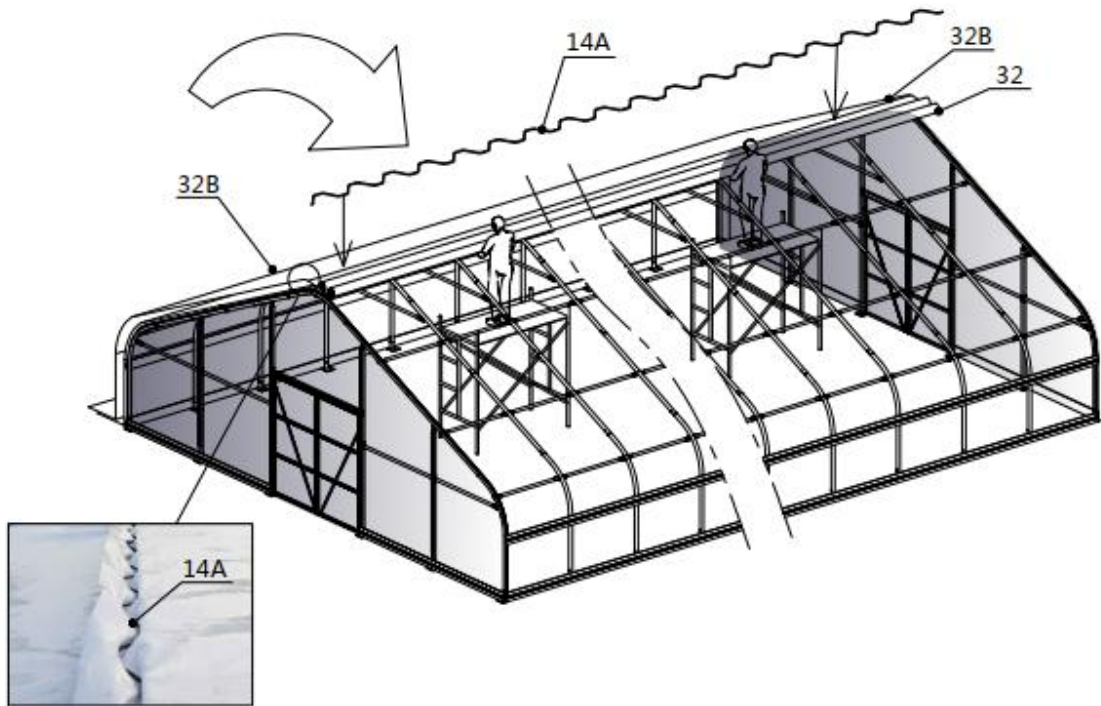

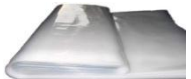
No.	Part	Qty
14A		9
32B		2

- Continue to install the inner film.

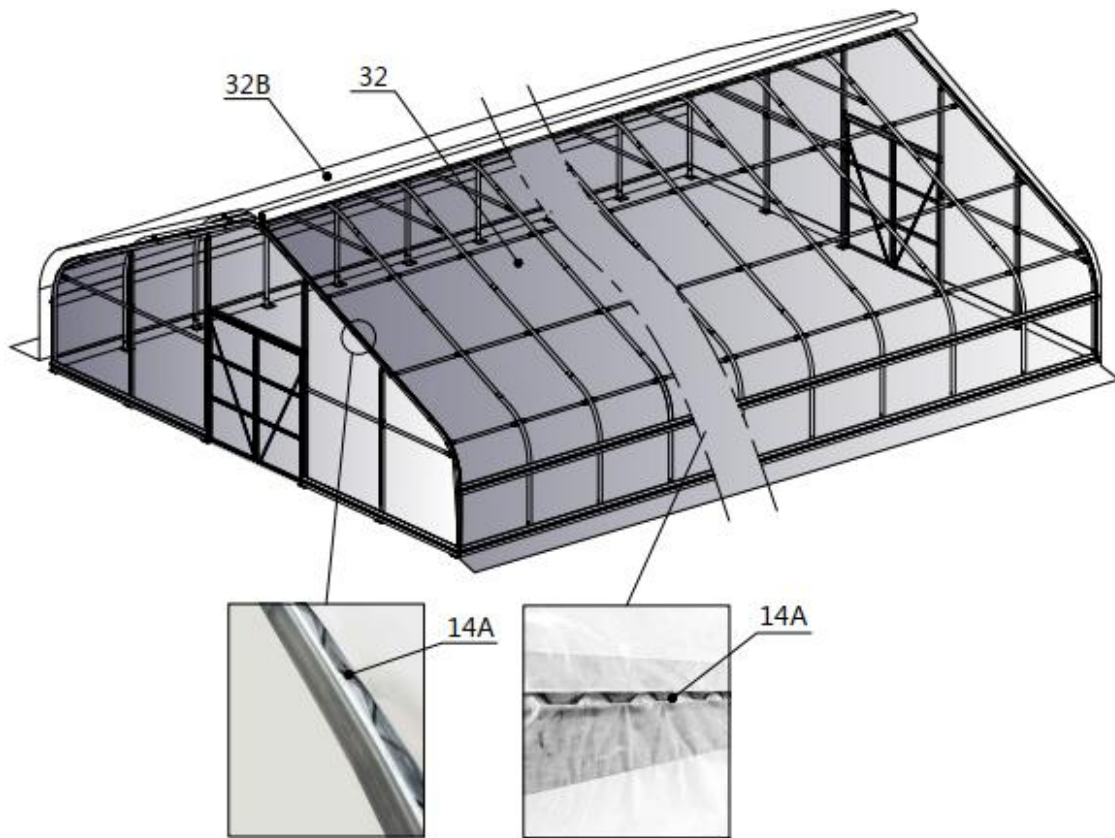







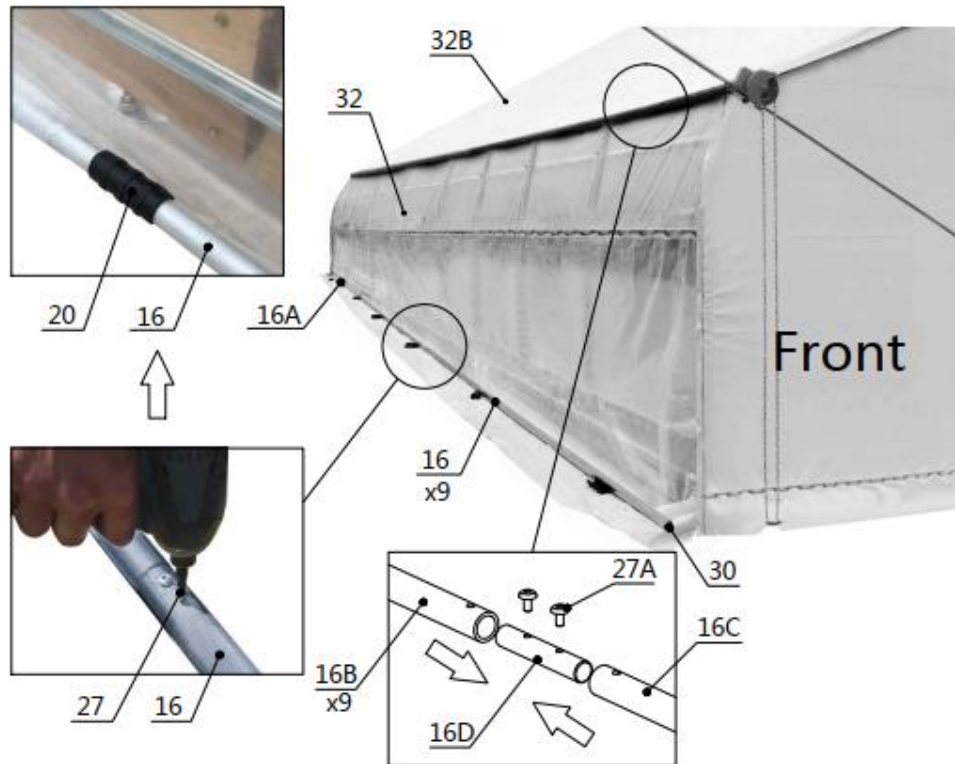

No.	Part	Qty
14A		17

Step 8 : Install roll film system.

- Install the roll film tube(#16,#16A) and (#16B,#16C), add a round plug (#30) at the end. the film (#32) is wound on a roll film tube (#16,#16A), the film (#32B) is wound on a roll film tube (#16B,#16C), and clamped with a pressure film carrier (#20).









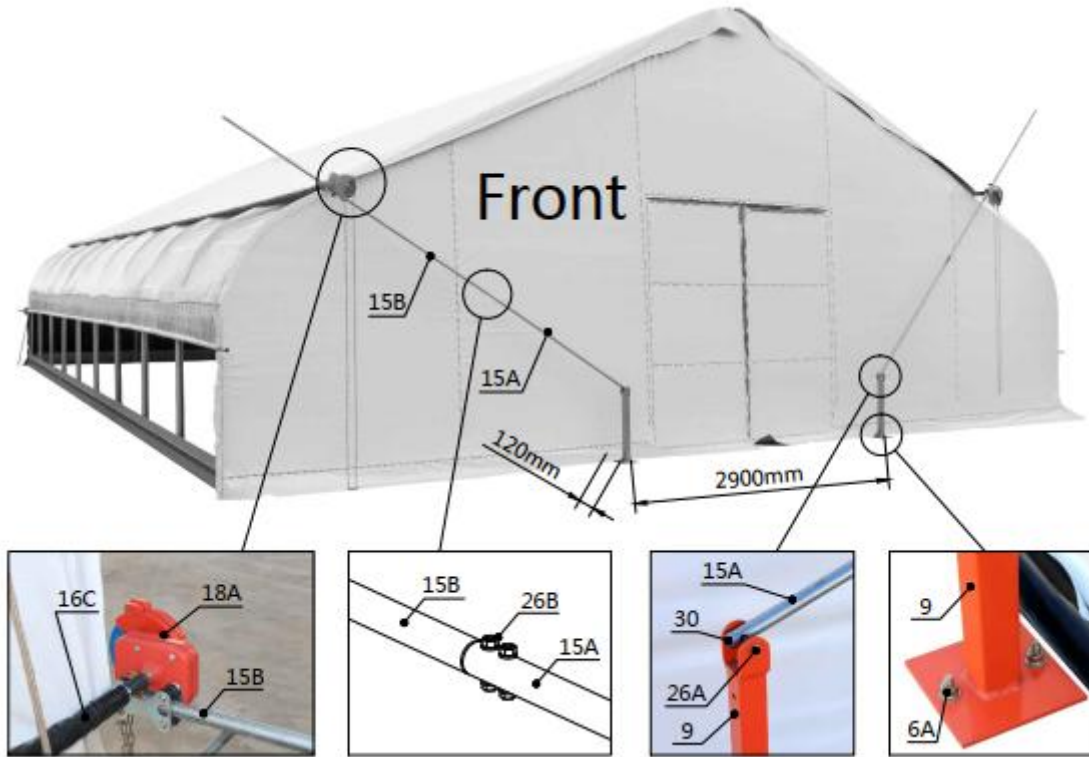

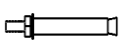
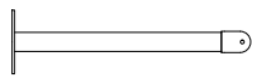
No.	Part	Qty
16		18
16A		2
16B		18
16C		2
16D		18

No.	Part	Qty
20		60
27		36
27A		36
30		4

- A round plug (#30) is put on both ends of the film rolling machine guide tube (#15A,#16), and the guide tube is mounted on the support with a hex bolt (#26A), and it is required to swing freely. The film rolling machine (#18A) drives the roll film tube (#16C,#16D) to be raised and lowered horizontally and flexibly without jamming.



No.	Part	Qty
6A		4
9		2
15A		2
15B		2
18A		2

No.	Part	Qty
26A		2
26B		4
27		4
30		4

- A round plug (#30) is put on both ends of the film rolling machine guide tube (#15), and the guide tube is mounted on the frame with a hex bolt (#26), and it is required to swing freely. The film rolling machine (#18) drives the roll film tube (#16,#16A) to be raised and lowered horizontally and flexibly without jamming.
- Install the eight clip spring (#19) and fasten the braided rope (#31).

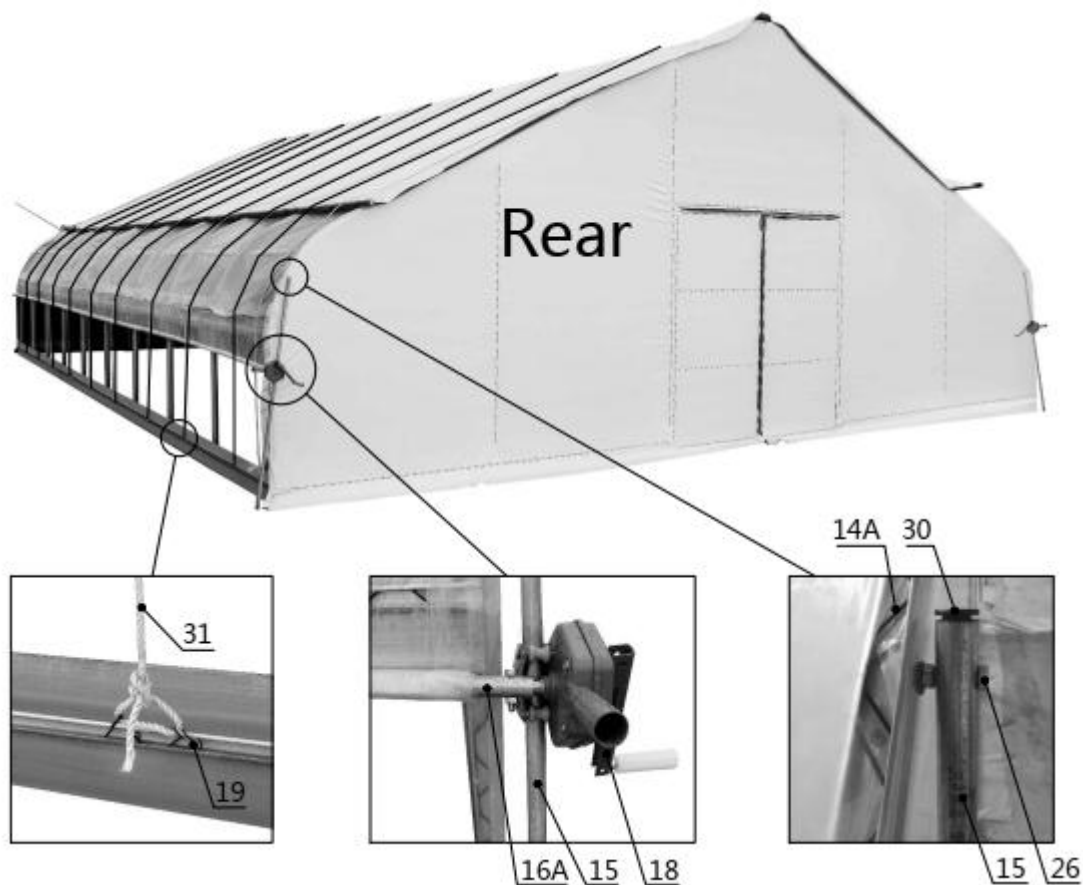

No.	Part	Qty
15		2
18		2
19		28

No.	Part	Qty
26		2
30		4
31		1

After the Installation

Walk around and inspect the tunnel greenhouse periodically to make sure all components are still firmly secured and the whole shelter is well supported. Check all bolts and nuts as well as all connection points to make sure they are all in good position.

We strongly recommend you remove any snow from the roof immediately. Do not leave any snow load on the roof overnight. Keep 3 feet of clearance on all sides at all times. Do not allow snow to accumulate and pile up on the sides of the building. Otherwise the pressure from the sides will push inwards and could lead to a collapse.