

### 30Ft x 150Ft Tunnel Greenhouse Grow Tent

Model: TMG-GH30150



- Please read the product manual completely before assembly
- Check against the parts list to make sure all parts are received
- Wear proper safety goggles or other protective gears while in assembly

Missing parts or questions on assembly?

Please call: 1-877-761-2819 or email: [cs@tmgindustrial.com](mailto:cs@tmgindustrial.com)

Do not return the product to dealer, they are not equipped to handle your requests

## **Main Specifications :**

- Overall assembled size : W9.15 x L45.5 x H3.66 (m) / W30 x L150 x H12 (ft)
- Shoulder height : H1.6 (m) / 5ft
- Door : W2.2 x H2 (m) / 7.2 x 6.6 (ft)

## **Prior to assembly**

Please read the instructions carefully before installation. It is important to follow your local safety regulations and industry standards during installation. Regulations may include but are not limited to :

- Safety helmets, protective eyewear, and clothing
- Safety harnesses for all elevated workers
- Proper ladder, cage, and safety operation

Check all components and parts before installation. All parts are marked with a part number, please refer to the parts list to make sure you have all parts.

















Choose a day with low or no wind to install, assembly is hard in heavy wind. Do not make any alterations to the structure. Do not hang any weights on the frame during installation, including parts. We are not responsible for any damages or injuries caused by inappropriate installation, unauthorized modifications or extreme weather.

















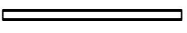

This building is not intended for human occupancy.











It is recommended to tape or add foam/rubber on the frame where joints connect and where it touches the cover. This will help extend the life span of the cover.

Read the following item list carefully and count the number of items to ensure that all parts are included prior to setup.

### TMG-GH30150 Part List

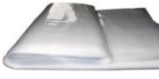
| Parts code | Graphical   | Description                                 | Qty | Box |
|------------|---|---|-----|-----|
| 1          |    | Peak arch tube                              | 36  | B   |
| 2          |    | Upper rafter tube                           | 68  | A   |
| 2A         |    | Upper rafter tube<br>(front and rear truss) | 4   | A   |
| 3          |    | Lower rafter tube                           | 68  | A   |
| 3A         |    | Lower rafter tube<br>(front and rear truss) | 4   | A   |
| 4          |    | Shoulder tube                               | 68  | A   |
| 4A         |   | Shoulder tube<br>(front and rear truss)     | 4   | A   |
| 5          |  | Roof purlin<br>(horizontal tube)            | 245 | B   |
| 6          |  | Base plate                                  | 72  | A   |
| 6A         |  | Expansion bolt $\phi$ 14x100mm              | 232 | B   |
| 7          |  | Base plate                                  | 8   | B   |
| 8          |  | Vertical tubes                              | 4   | B   |
| 8A         |  | Vertical tubes                              | 4   | B   |
| 9L         |  | Door left lower vertical tubes              | 2   | B   |
| 9A         |  | Door left upper vertical tubes              | 2   | B   |
| 9R         |  | Door right lower vertical tubes             | 2   | B   |
| 9B         |  | Door right upper vertical tubes             | 2   | B   |

|     |   |                                 |     |   |
|-----|---|---------------------------------|-----|---|
| 9C  |    | Connector tube                  | 8   | B |
| 10  |    | Door cross tubes                | 4   | B |
| 10A |    | Door cross tubes                | 4   | B |
| 10B |    | Door frame cross pull tube      | 2   | B |
| 11  |    | Ceiling cross bar               | 34  | B |
| 12  |    | Door frame column tube          | 4   | B |
| 12L |    | Door frame column left tube     | 2   | B |
| 12R |    | Door frame column right tube    | 2   | B |
| 13  |    | Door horizontal tube            | 16  | B |
| 14  |  | Reed groove                     | 144 | B |
| 14A |  | Clip spring                     | 144 | B |
| 15  |  | Film rolling machine guide tube | 2   | B |
| 16  |  | Roll film tube                  | 46  | B |
| 16A |  | Roll film tube                  | 2   | B |
| 17  |  | Door buckle                     | 8   | B |
| 18  |  | Film rolling machine            | 2   | B |
| 19  |  | Eight clip spring               | 142 | B |
| 20  |  | Pressure film carrier           | 72  | B |

|     |   |  |          |   |
|-----|---|--|----------|---|
| 21  |    | Half round head bolt M6x50             | 32       | B |
| 22  |    | Self locking bolt<br>M10x80mm and nuts | 252      | B |
| 23  |    | Self locking bolt<br>M8x70mm and nuts  | 576      | B |
| 24  |    | Hex bolt<br>M10x70mm and nuts          | 32       | B |
| 25  |    | Hex bolt<br>M10x30mm and nuts          | 80       | B |
| 26  |    | Hex bolt<br>M10x120mm and nuts         | 2        | B |
| 27  |    | Self tapping screw #12x25              | 860      | B |
| 28  |   | Self tapping screw #12x35              | 312      | B |
| 29  |  | Square plug                            | 16       | B |
| 30  |  | Round plug ( φ 25 )                    | 6        | B |
| 31  |  | Braided rope (200m)                    | 1 bundle | B |
| 32  |  | Top cover film                         | 1        | B |
| 32A |  | Front and rear door film               | 2        | B |
| 33  |  | Adhesive tape                          | 9        | B |
| 34  |  | Socket wrench                          | 1        | B |
| 35  |  | Hex wrench                             | 1        | B |
| 36  |  | Board 150x15x2000mm<br>(not included)  | 100      | B |

## Installation steps

### Step 1 : Review the whole structure and choose the proper installation site

- Choose a solid flat level ground area to set up the building. Do not install the building on soft ground, wetland, uneven surfaces, sloped surfaces.
- We strongly recommend that you build the structure on a solid foundation such as cement and use anchor bolts on all base plates.
- Be aware of the surrounding area. Do not set up the building near snowdrifts, open flames or exposed electrical wires. Do not keep heat sources near the fabric cover. Keep the building surroundings clear at all times
- Mark the ground in the final building location with a line showing the positions of base plates, front doors. All lines should be drawn from center to center of all base plate tubes. Diagonal line X must be equal to Y.
- Base plates: all base plates must be installed firmly with expansion bolts (#6A) on this step (refer to figure 1).
- Parts used in this step :
  - (72) Base plate (#6)
  - (8) Door column base plate (#7)
  - (232) Expansion bolts (#6A)

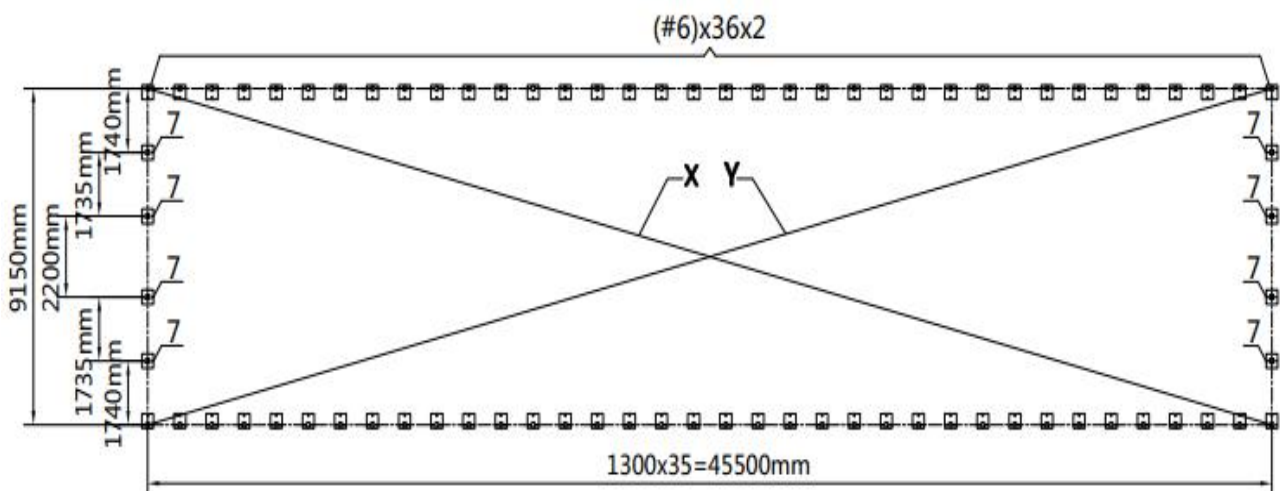
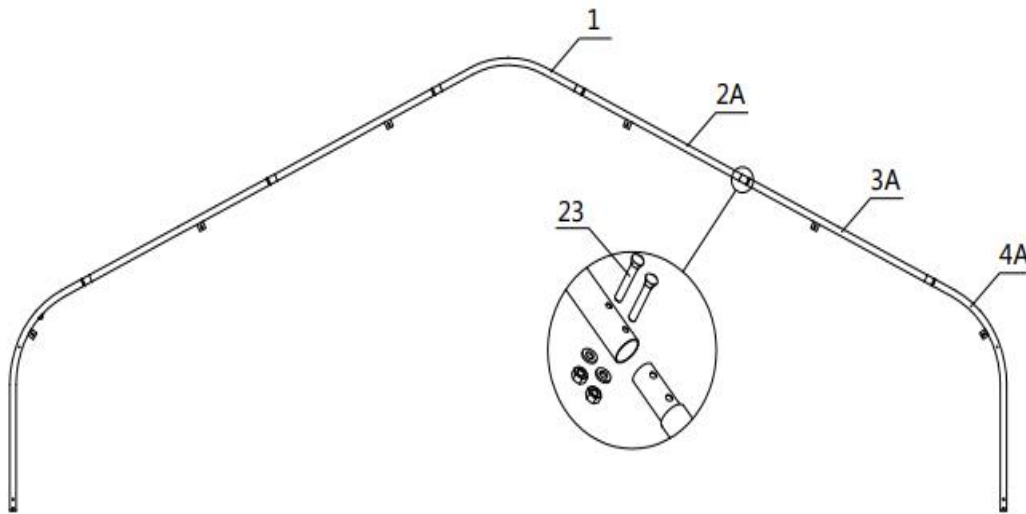

Figure 1

## Step 2 : Assemble all trusses

- The building includes 36 trusses : (2) front and rear truss, and (34) middle trusses.
- Parts used to install the front and rear truss in this step (refer to figure 2) :
  - (1x2) Peak arch tube (#1)
  - (2x2) Upper rafter tube (#2A)
  - (2x2) Lower rafter tube (#3A)
  - (2x2) Shoulder tube (#4A)
  - (12x2) Self locking bolt (#23)



**Figure 2**

- Parts used to install (34) middle trusses in this step (refer to figure 3) :
  - (1x34) Peak arch tube (#1)
  - (2x34) Upper rafter tube (#2)
  - (2x34) Lower rafter tube (#3)
  - (2x34) Shoulder tube (#4)
  - (1x34) Ceiling cross bar (#11)
  - (12x34) Self locking bolt (#23)
  - (2x34) Hex bolt (#25)

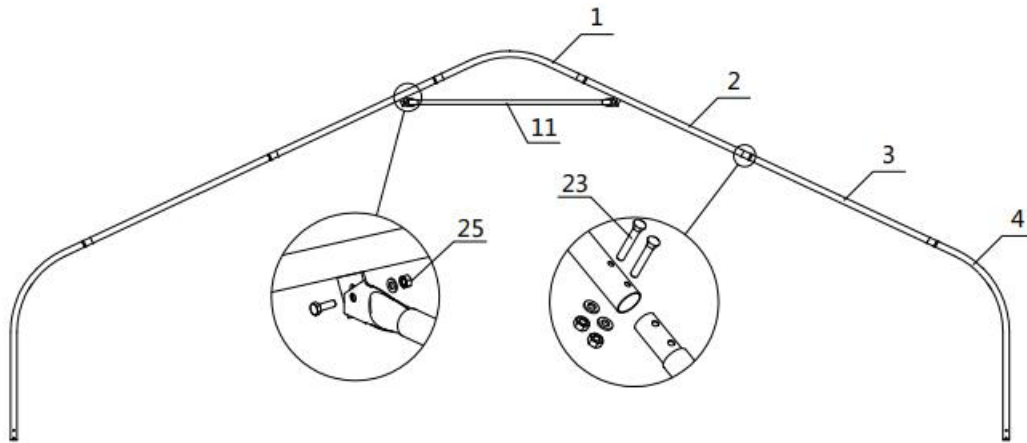

**Figure3**

- Lay down all (36) trusses on the ground when the assembly is all completed and before moving to next step, and then wrap (#33) around the sharp points of the joint to avoid friction between the fabric and the interface, resulting in fabric damage. (refer to figure 4)

- (9) Adhesive tape (#33)

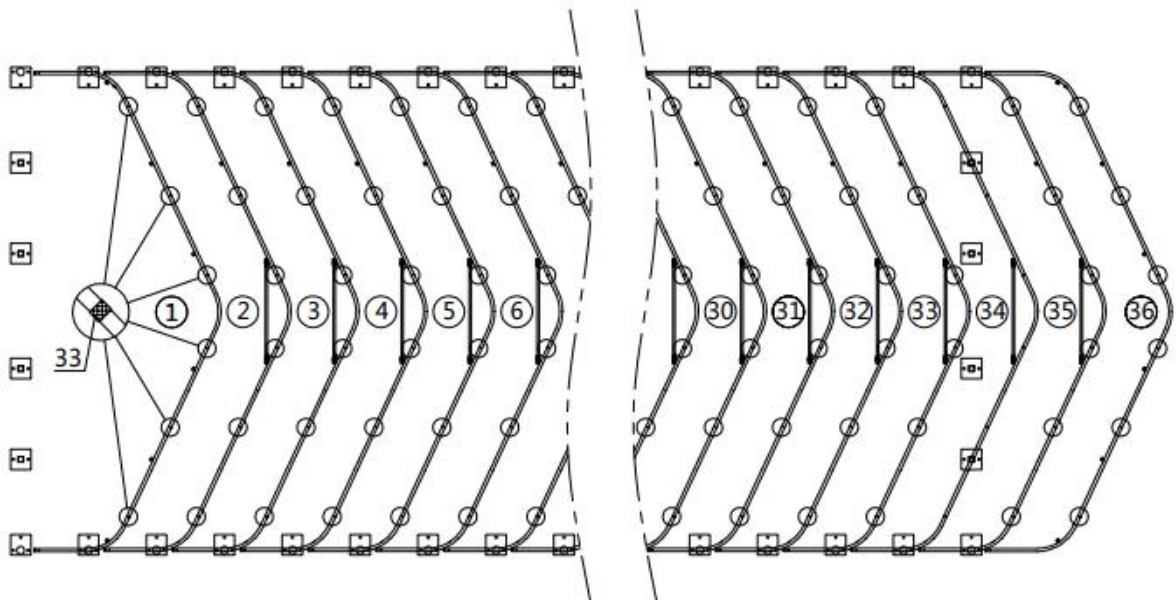

**Figure 4**

**Step 3 : Put up all trusses (refer to figure 5)**

- Put up the front truss, use hex bolt (#23) to secure the truss to the base



plates.

- Parts used in this step :
  - (4) Self locking bolt (#23)

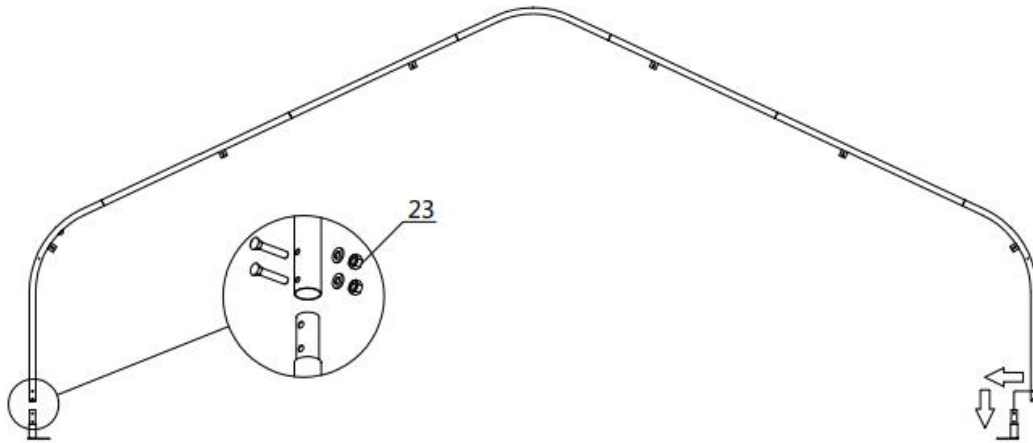

**Figure 5**

- Repeat above step to put up all other trusses (from 2th to 36th truss), and connect all purlins. Now the whole structure is completely up. (refer to figure 6)
- Parts used in this step :
  - (7x35) Roof purlin (#5)
  - (7x36) Self locking bolt (#22)
  - (4x35) Self locking bolt (#23)

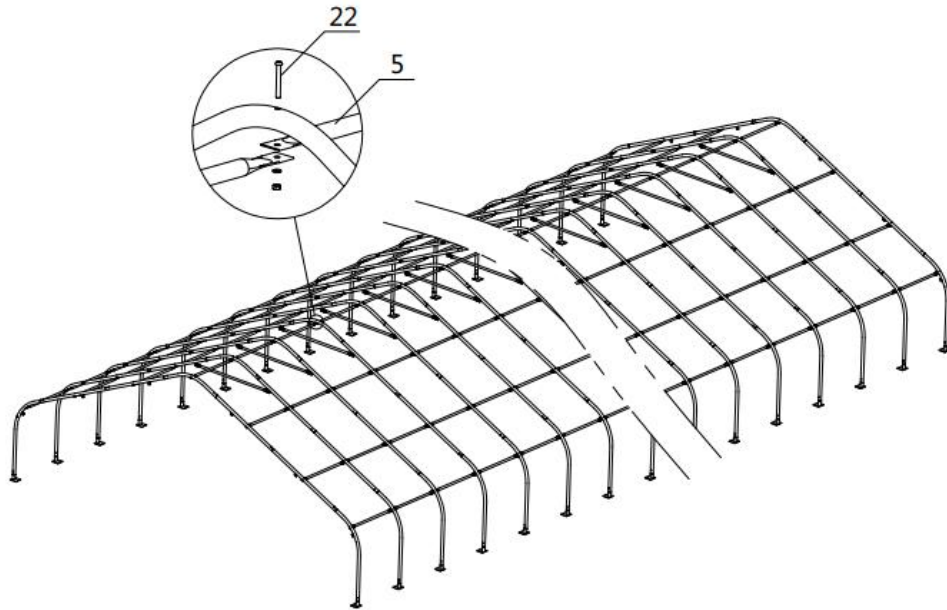

**Figure 6**

**Step 4 : Installation of front and rear trusses (refer to figure 7)**

- (2x2) Vertical tubes (#8)
- (2x2) Vertical tubes (#8A)
- (1x2) Door left lower vertical tubes (#9L)
- (1x2) Door left upper vertical tubes (#9A)
- (1x2) Door right lower vertical tubes (#9R)
- (1x2) Door right upper vertical tubes (#9B)
- (4x2) Connector tube (#9C)
- (2x2) Door cross tubes (#10)
- (2x2) Door cross tubes (#10A)
- (1x2) Door frame cross pull tube (#10B)
- (2x2) Door frame column tube (#12)
- (1x2) Door frame column left tube (#12L)
- (1x2) Door frame column right tube (#12R)
- (8x2) Door horizontal tube (#13)
- (16x2) Half round head bolt (#21)
- (16x2) Hex bolt (#24)
- (6x2) Hex bolt (#25)
- (8x2) Square plug (#29)

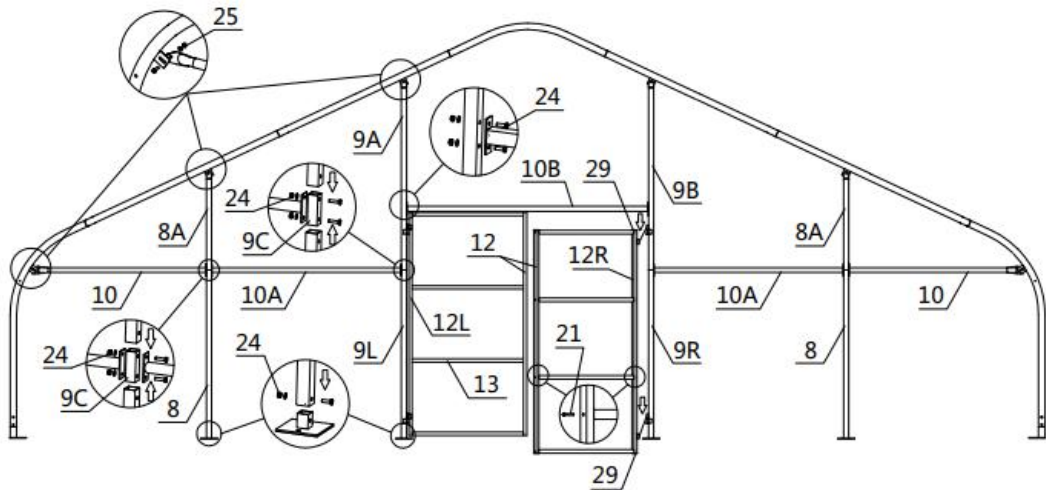
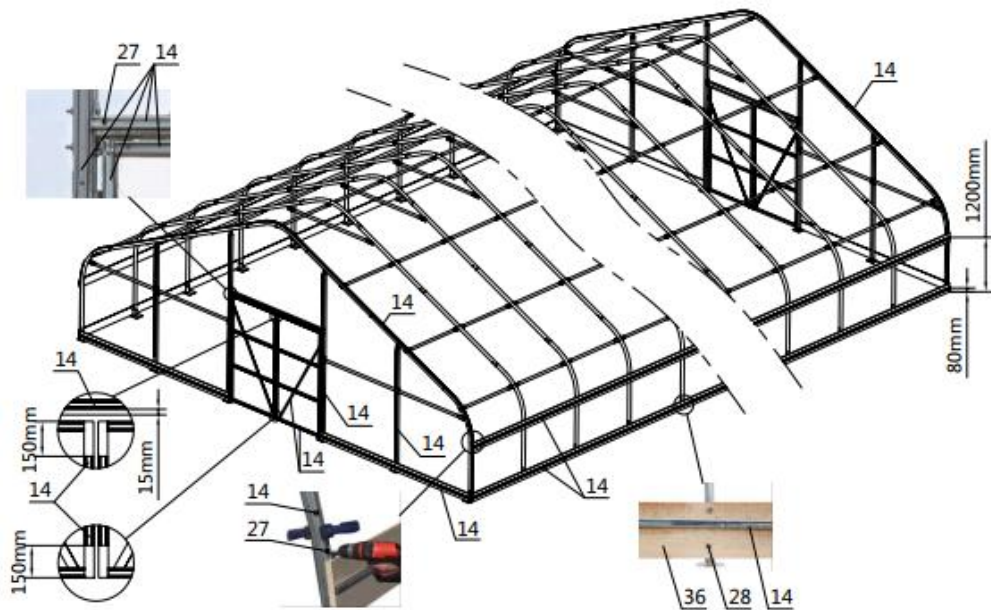

**Figure 7**

- The whole structure inspection : check all components and trusses to make sure the whole structure is squared to the base line drawn at the step 1. All trusses must be set up righted at 90 degree. All purlins must be straight in line. If any purl ins are not in line with they will need to be corrected before moving to the next step.
- Now it is the time to secure all bolts and nuts firm on the structure. But do not over-tight the bolts, otherwise the tubes might be damaged.

**Step 5 : Installing boards (#36) and reed groove (#14) (refer to figure 8)**

- Fix the board (#36) with self tapping screw (#28).
- Fix the reed groove (#14) with the self tapping screw (#27).
- Parts used in this step :
  - (144) Reed groove (#14)
  - (720) Self tapping screw (#27)
  - (312) Self tapping screw (#28)
  - (100) Board (#36)



**Figure 8**

**Step 6 : Install front and rear film (refer to figure 9)**

- Lift the film (#32A) and fix the film with a clip spring (#14A) from top to bottom.
- Install door buckle (#17) with self tapping screw (#27).
- Cut the door film as shown.
- Parts used in this step :
  - (24x2) Clip spring (#14A)
  - (4x2) Door buckle (#17)
  - (24x2) Self tapping screw (#27)
  - (1x2) Front and rear door film (#32A)

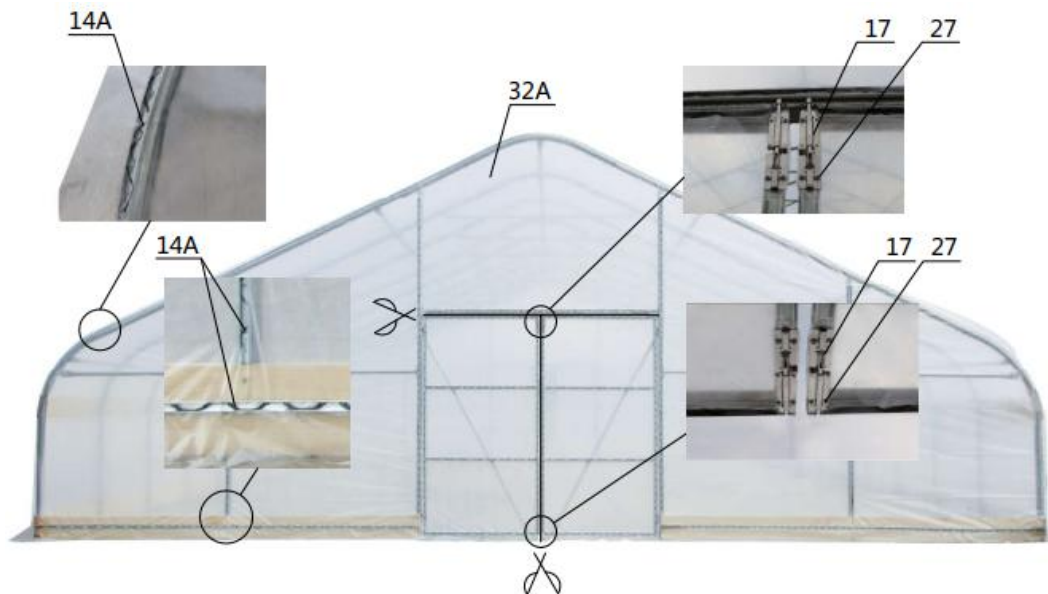

**Figure 9**

**Step 7 : Install the film and roll film system (refer to figure 10)**

NOTE : The cover must be installed on a windless day. DO NOT attempt to install the cover during windy conditions.

- when you are ready to install the roof cover, unpack the cover and position it parallel to the building frame on one side. The truss connection is wrapped with adhesive tape (#33) to reduce the friction between the frame and the film. the cover must be pulled over the top of the truss frame without being snagged or stressed on any frame members. tighten the film evenly to eliminate wrinkles and make the film flat and smooth. Do not over-tighten during the adjustment process, otherwise it will cause unnecessary damage. At this time, you can install a clip spring (#14A) to fix the film.
- Installation of roll film systems.

A round plug (#30) is put on both ends of the film rolling machine guide tube (#15), and the guide tube is mounted on the frame with a hex bolt (#26), and it is required to swing freely. After using a self tapping screw (#27) to connect the roll film tube (#16), lay it flat on both sides of the frame. The film (#32) is wound on a roll film tube (#16), and clamped with a pressure film carrier (#20). The film rolling machine (#18) drives the roll film tube (#16) to be raised and lowered horizontally and flexibly without jamming.

- Install the eight clip spring (#19) and fasten the braided rope (#31).

- Parts used in this step :
  - (96) Clip spring (#14A)
  - (2) Film rolling machine guide tube (#15)
  - (46) Roll film tube (#16)
  - (2) Roll film tube (#16A)
  - (2) Film rolling machine (#18)
  - (142) Eight clip spring (#19)
  - (72) Pressure film carrier (#20)
  - (2) Hex bolt (#26)
  - (92) Self tapping screw (#27)
  - (6) Round plug (#30)
  - (1) Braided rope (#31)
  - (1) Film (#32)

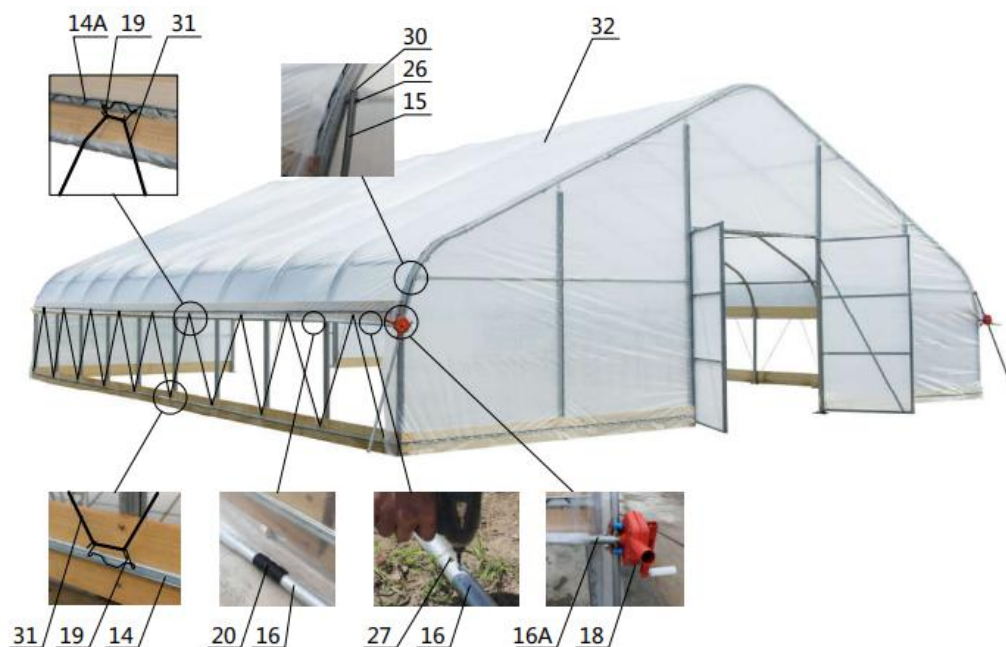

**Figure 10**

### **After the Installation**

Walk around and inspect the tunnel greenhouse periodically to make sure all components are still firmly secured and the whole shelter is well supported. Check all bolts and nuts as well as all connection points to make sure they are all in good position.

We strongly recommend you remove any snow from the roof immediately. Do not leave any snow load on the roof overnight. Keep 3 feet of clearance on all sides at all times. Do not allow snow to accumulate and pile up on the sides of the building. Otherwise the pressure from the sides will push inwards and could lead to a collapse.