

# 12' X 20' TUNNEL GREENHOUSE GROW TENT

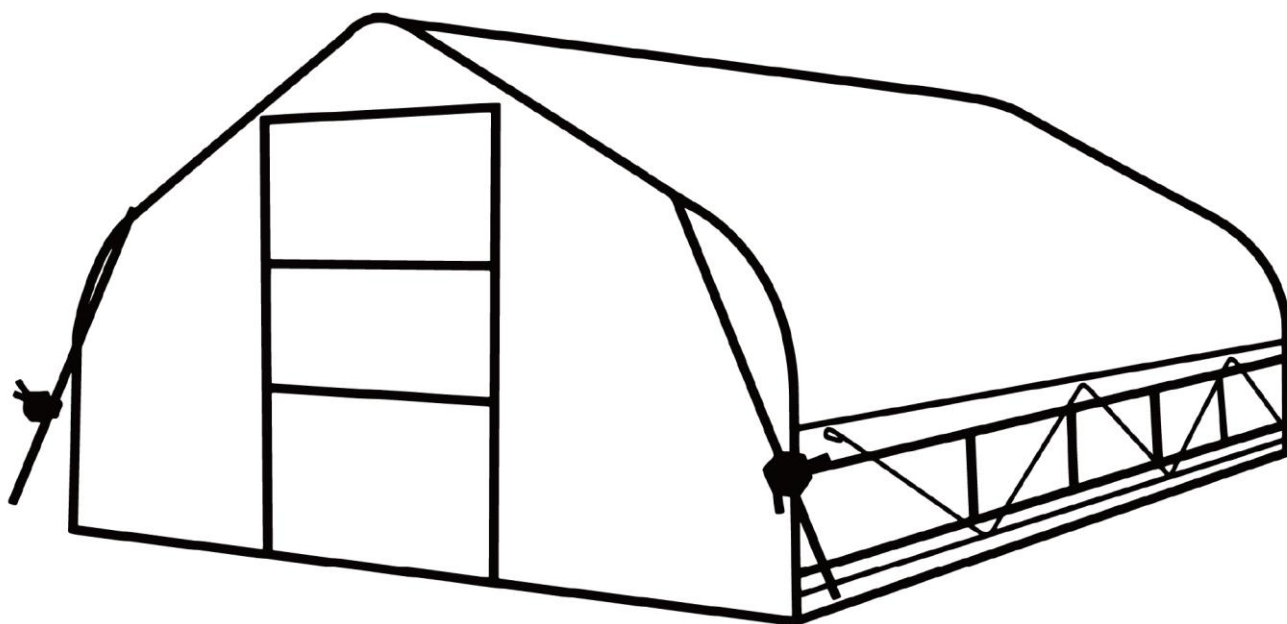

## ⚠ WARNING



- Please read and understand the product manual completely before assembly
- Check against the parts list to make sure all parts are received
- Wear proper safety goggles or other protective gears while in assembly
- Do not return the product to dealer. They are not equipped to handle your requests.

Missing parts or have questions on assembly?

Please call: 1-877-761-2819 or email: [cs@tmgindustrial.com](mailto:cs@tmgindustrial.com)

## **MAIN SPECIFICATIONS :**

- Overall assembled size : L6.5 x W3.66 x H2.2 (m) / L21 x W12 x H7.2 (ft)
- Shoulder height : H1.2 (m) / 4 ft
- Door : W1.2 x H1.8 (m) / 4 x 6 (ft)

## **PRIOR TO ASSEMBLY**

Please read the instructions carefully before installation. It is important to follow your local safety regulations and industry standards during installation. Regulations may include but are not limited to :

- Safety helmets, protective eyewear, and clothing
- Safety harnesses for all elevated workers
- Proper ladder, cage, and safety operation

Check all components and parts before installation. All parts are marked with a part number, please refer to the parts list to make sure you have all parts.













Choose a day with low or no wind to install, assembly is hard in heavy wind. Do not make any alterations to the structure. Do not hang any weights on the frame during installation, including parts. We are not responsible for any damages or injuries caused by inappropriate installation, unauthorized modifications or extreme weather.



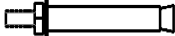



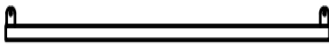





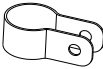

This building is not intended for human occupancy.

It is recommended to tape or add foam/rubber on the frame where joints connect and where it touches the cover. This will help extend the life span of the cover.

Read the following item list carefully and count the number of items to ensure that all parts are included prior to setup.

**TMG-GH1220 PART LIST**

<b>PARTS CODE</b>	<b>GRAPHICAL</b>	<b>DESCRIPTION</b>	<b>QTY</b>
1		Peak arch tube	6
2		Upper rafter tube	12
3		Shoulder tube	12
4		Sidewall tube	12
5		Roof purlin (horizontal tube)	25
6		Base plate	13
6A		Door column base plate	2
6B		Expansion bolt $\phi 14 \times 100 \text{mm}$	30
7		Front door cross tubes	2
8		Rear door cross tubes	2
9		Upper vertical tubes for rear truss	1
10		Lower vertical tubes for rear truss	1
11		Door frame cross pull tube (front truss)	1
12		Door frame left tube (front truss)	1

13		Door frame right tube (front truss)	1
14		Door frame column left tube	1
15		Door frame column right tube	1
16		Door horizontal tube	4
17		Film rolling machine guide tube	2
18		Roll film tube	6
18A		Roll film tube	2
19		Tube clamp	6
20		Door buckle	1
21		Film rolling machine	2
22		Reed groove	34
22A		Clip spring	34
23		Eight clip spring	12
24		Pressure film carrier	12
25		Half round head bolt M6x50	40

26		Hex bolt M6x45	60
27		Hex bolt M6x80	2
28		Self tapping screw #12x25	182
28A		Self tapping screw #12x35	4
29		Self tapping screw #12x35	62
30		Socket wrench	1
30A		Hex wrench	1
31		Square plug	6
32		Round plug	6
33		Braided rope	1 bundle (20m)
34		Adhesive tape	1
35		Top cover film	1
35A		Front and rear film	2
36		Board (not included)	34 meters

**INSTALLATION STEPS**

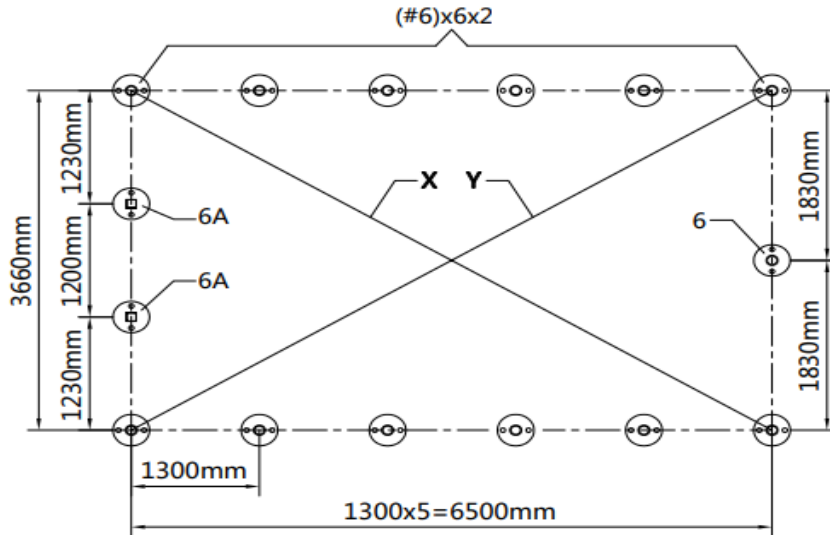

**STEP 1 : REVIEW THE WHOLE STRUCTURE AND CHOOSE THE PROPER INSTALLATION SITE.**

- Choose a solid flat level ground area to set up the building. Do not install the building on soft ground, uneven surfaces, sloped surfaces.
- We strongly recommend that you build the structure on a solid foundation such as cement and use anchor bolts on all base plates.
- Be ware of the surrounding area. Do not set up the building near snowdrifts, open flames or exposed electrical wires. Do not keep heat sources near the fabric cover. Keep the building surroundings clear at all times.
- Mark the ground in the final building location with a line showing the positions of base plates, front doors. All lines should be drawn from center to center of all base plate tubes. Diagonal line X must be equal to Y.
- Base plates: all base plates must be installed firmly with expansion bolts (#6B) on this step.

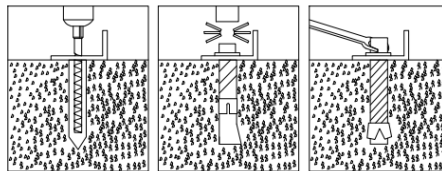

- Installation diagram of expansion bolt.





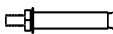

NO.	PART	QTY
6		13
6A		2

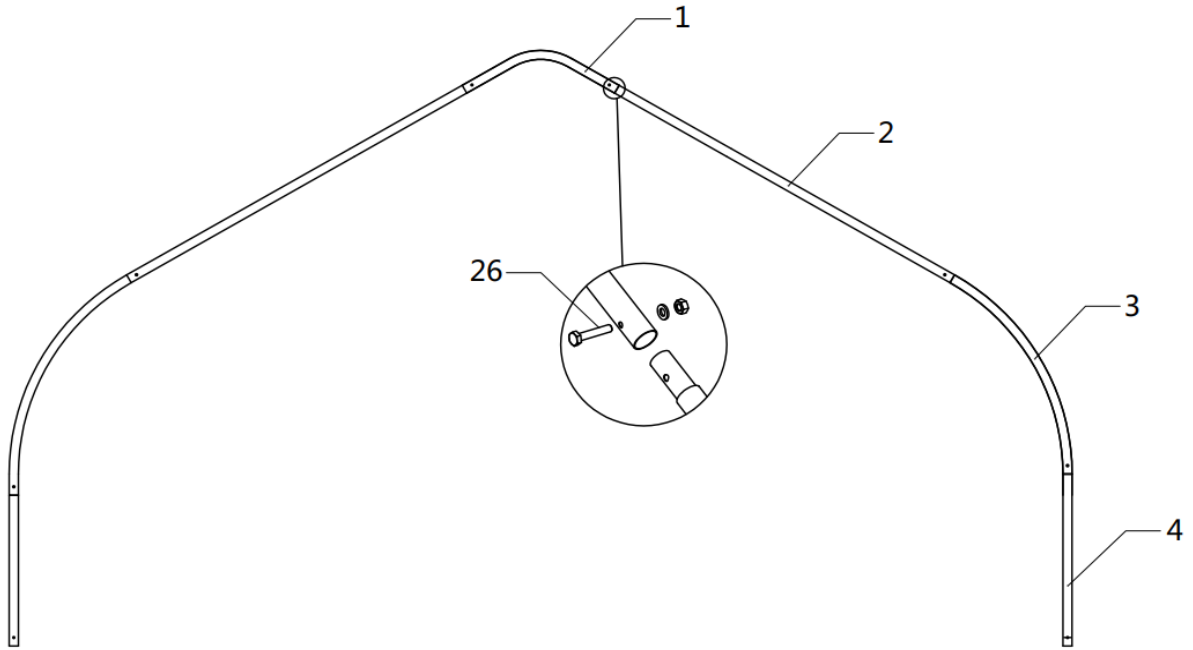

NO.	PART	QTY
6B		30

**STEP 2 : ASSEMBLE ALL TRUSSES.**

- The building includes 6 trusses , Connect all pipes with hex bolt (#26).



NO.	PART	QTY
1		6
2		12
3		12

NO.	PART	QTY
4		12
26		36

- Lay down all (6) trusses on the ground when the assembly is all completed and before moving to next step, and then wrap (#34) around the sharp points of the joint to avoid friction between the fabric and the interface, resulting in fabric damage.

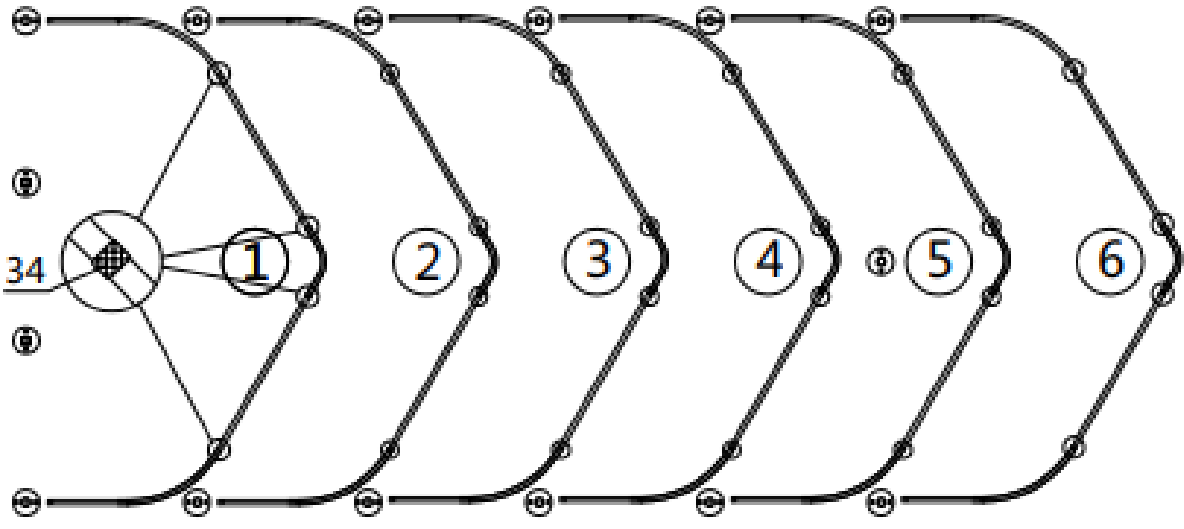

NO.	PART	QTY
34		1





**STEP 3 : PUT UP ALL TRUSSES**

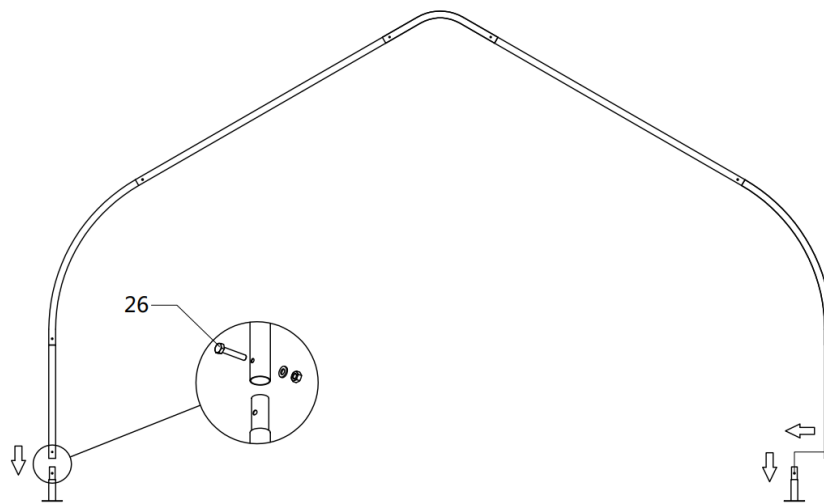

- Put up the truss, use hex bolt (#26) to secure the truss to the base plates.

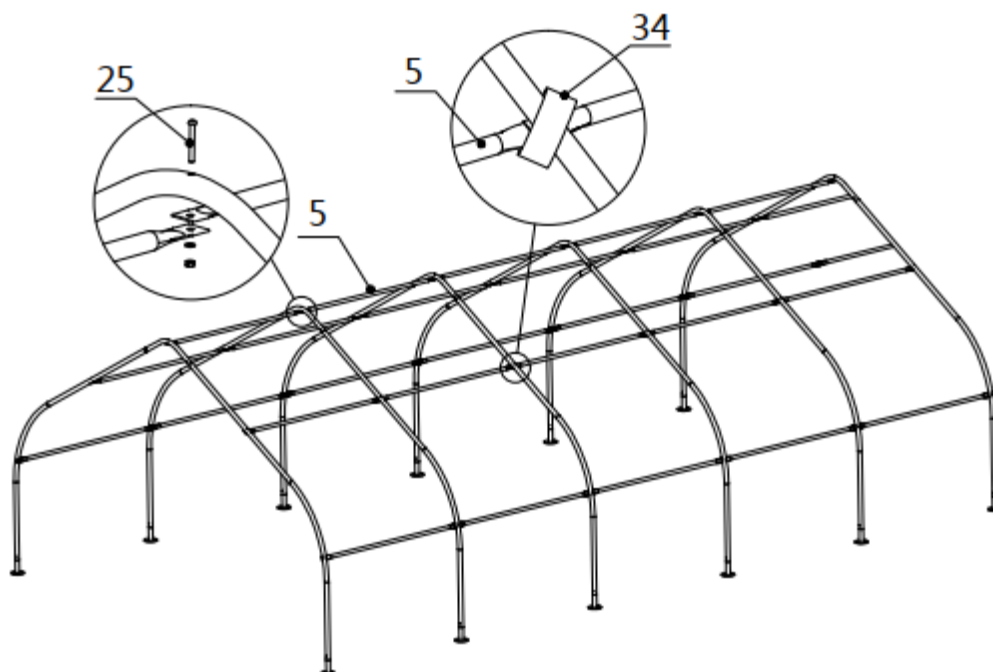

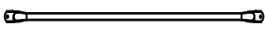
- Connect all purlins, and then wrap (#34) around the sharp points.



NO.	PART	QTY
5		25
25		30

NO.	PART	QTY
26		12
34		1

**STEP 4 : INSTALLATION OF FRONT AND REAR TRUSSES.**

- Installation of the front truss.

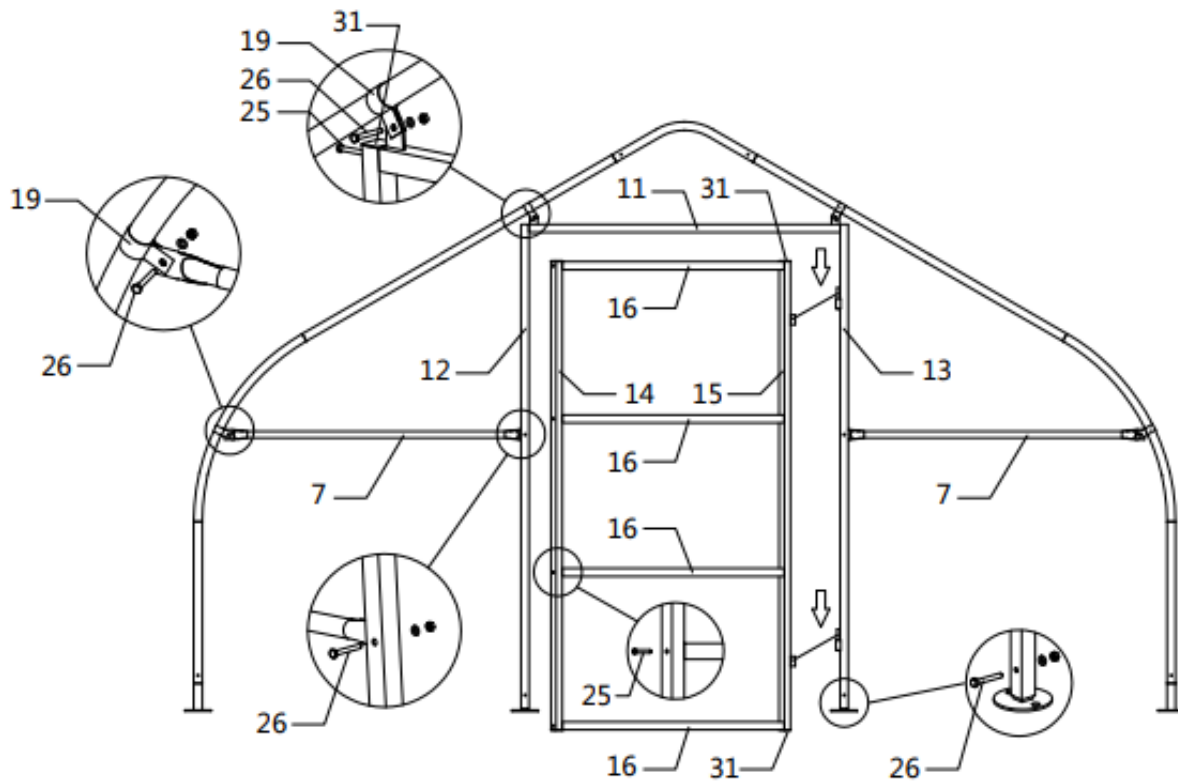



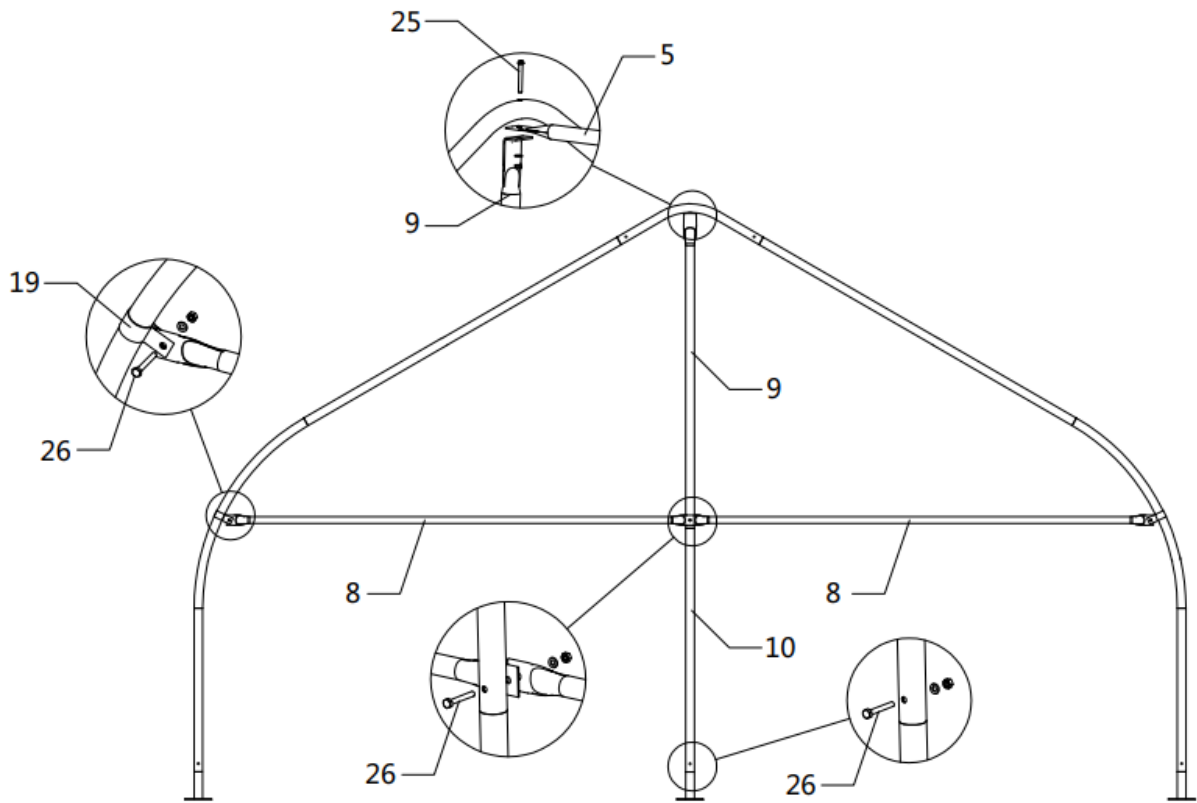

NO.	PART	QTY
7		2
11		1
12		1
13		1
14		1
15		1

NO.	PART	QTY
16		4
19		4
25		10
26		8
31		6

- Installation of the rear truss.

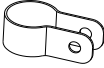

NO.	PART	QTY
8		2
9		1
10		1



NO.	PART	QTY
19		2
26		4

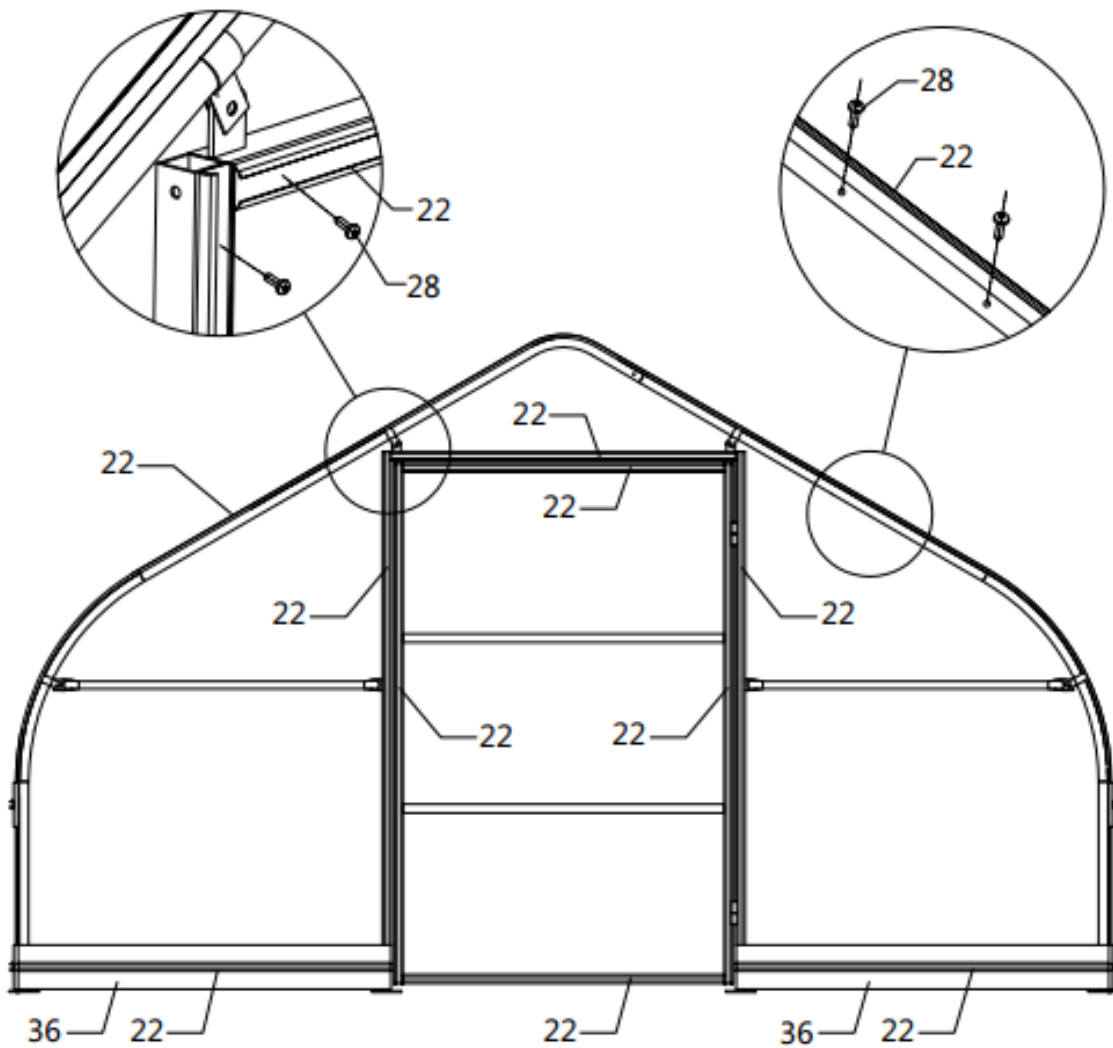

**STEP 5 : INSTALL BOARDS (#36) AND REED GROOVE (#22)**

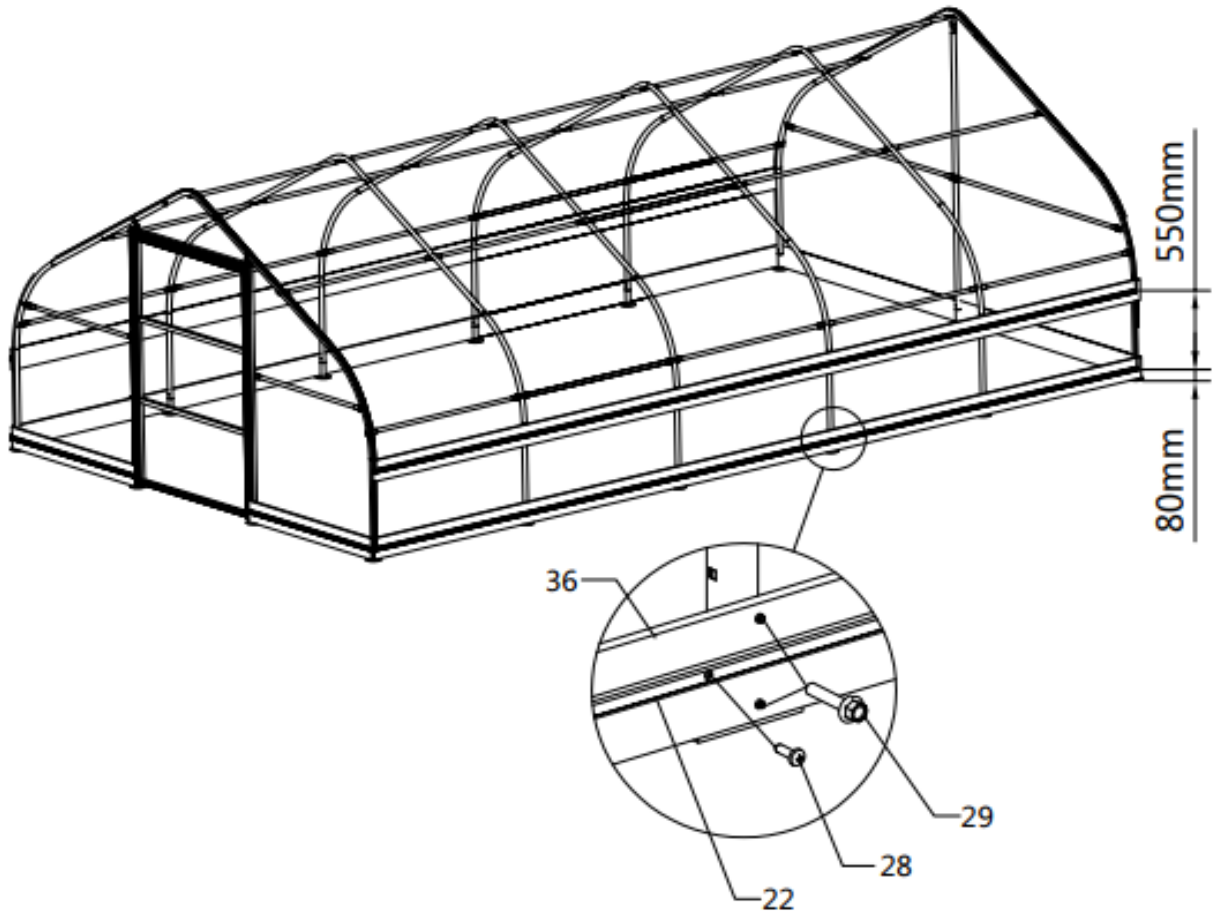
- Fix the board (# 36) with self tapping screw (# 29).
- Fix the reed groove (# 22) with the self tapping screw (# 28).







NO.	PART	QTY
22		34
28		170

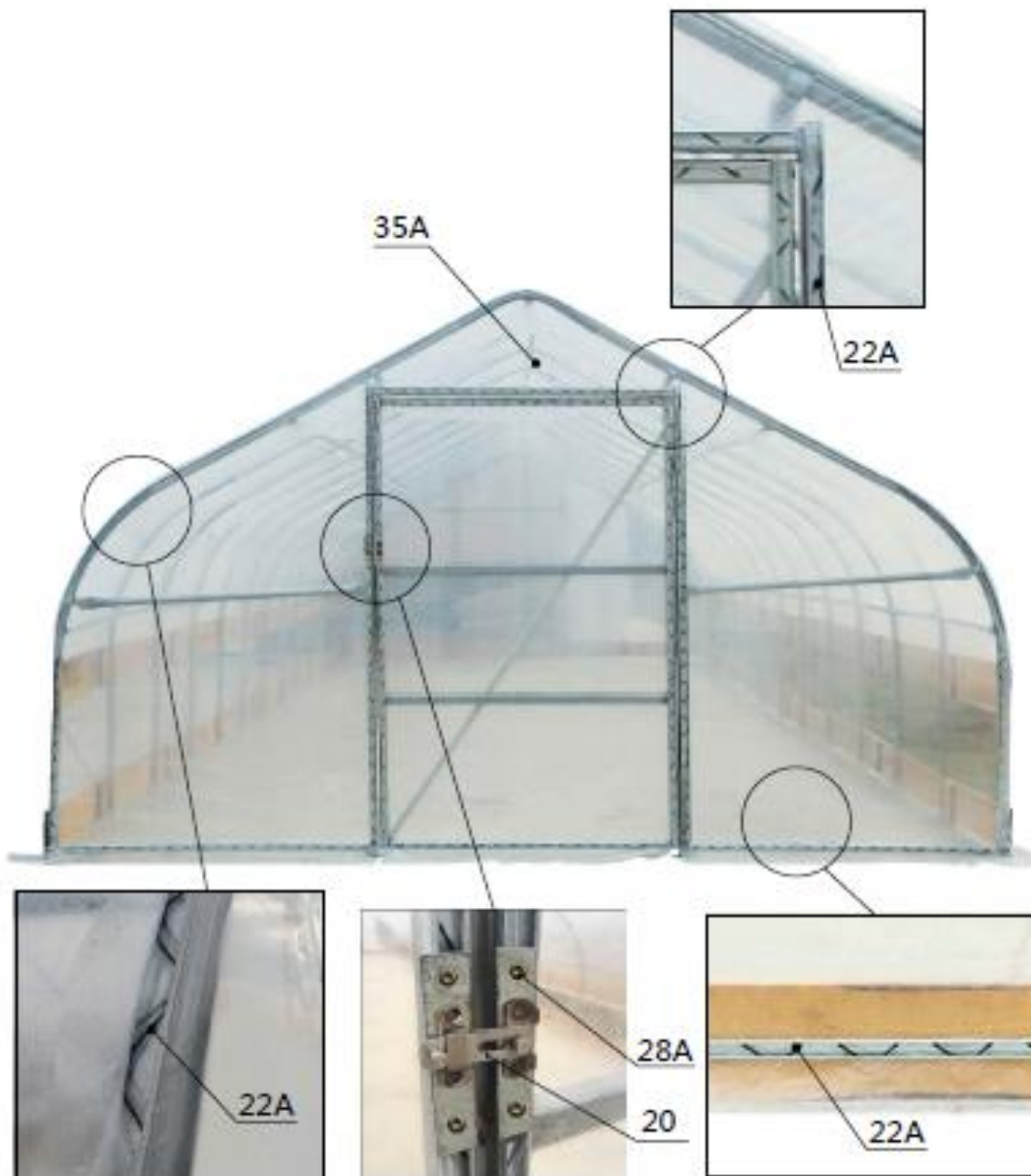

NO.	PART	QTY
29		62
36		34

**STEP 6 : INSTALL THE FILM.**

- Install the front film.



NO.	PART	QTY
20		1
22A		11

NO.	PART	QTY
28A		4
35A		1

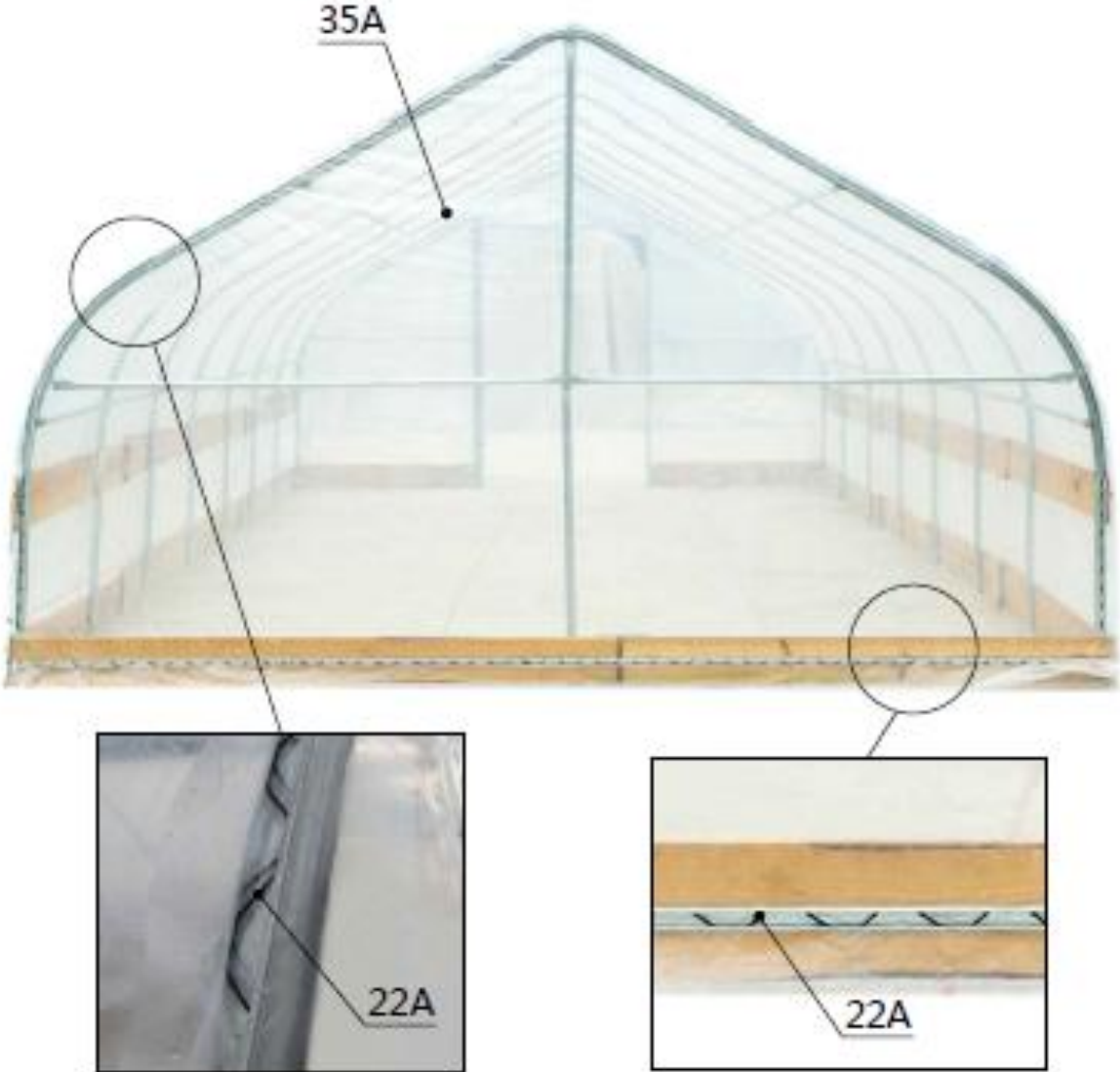

- Install the rear film.

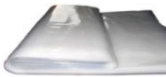

NO.	PART	QTY
22A		6
35A		1

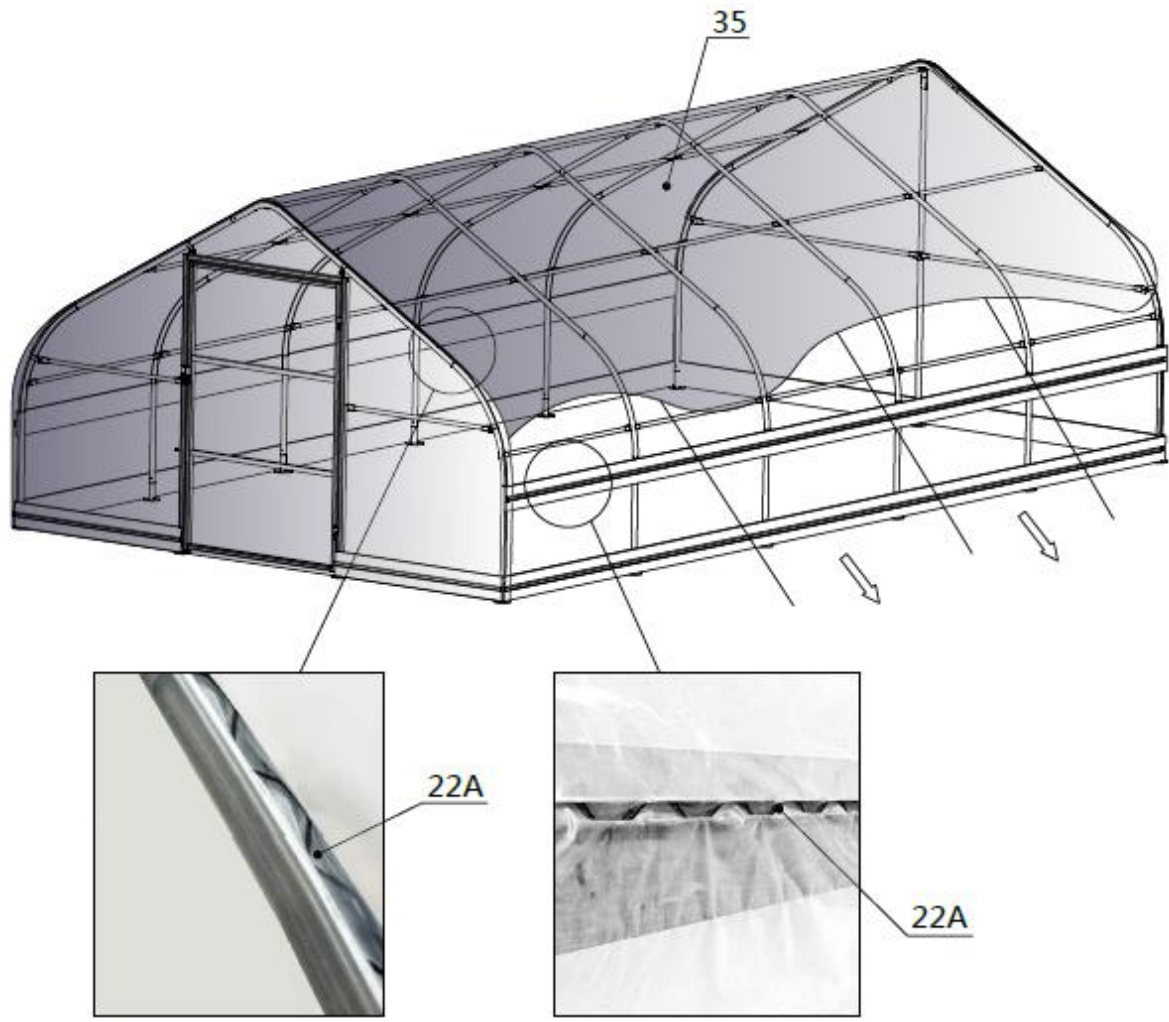
- When you are ready to install the roof cover, unpack the cover and position it parallel to the building frame on one side. the cover must be pulled over the top of the truss frame without being snagged or stressed on any frame members. tighten the film evenly to eliminate wrinkles and make the film flat and smooth. Do not over-tighten during the adjustment process, otherwise it will cause unnecessary damage. At this time, you can install a clip spring (#22A) to fix the film.

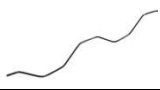





NO.	PART	QTY
22A		17
35		1

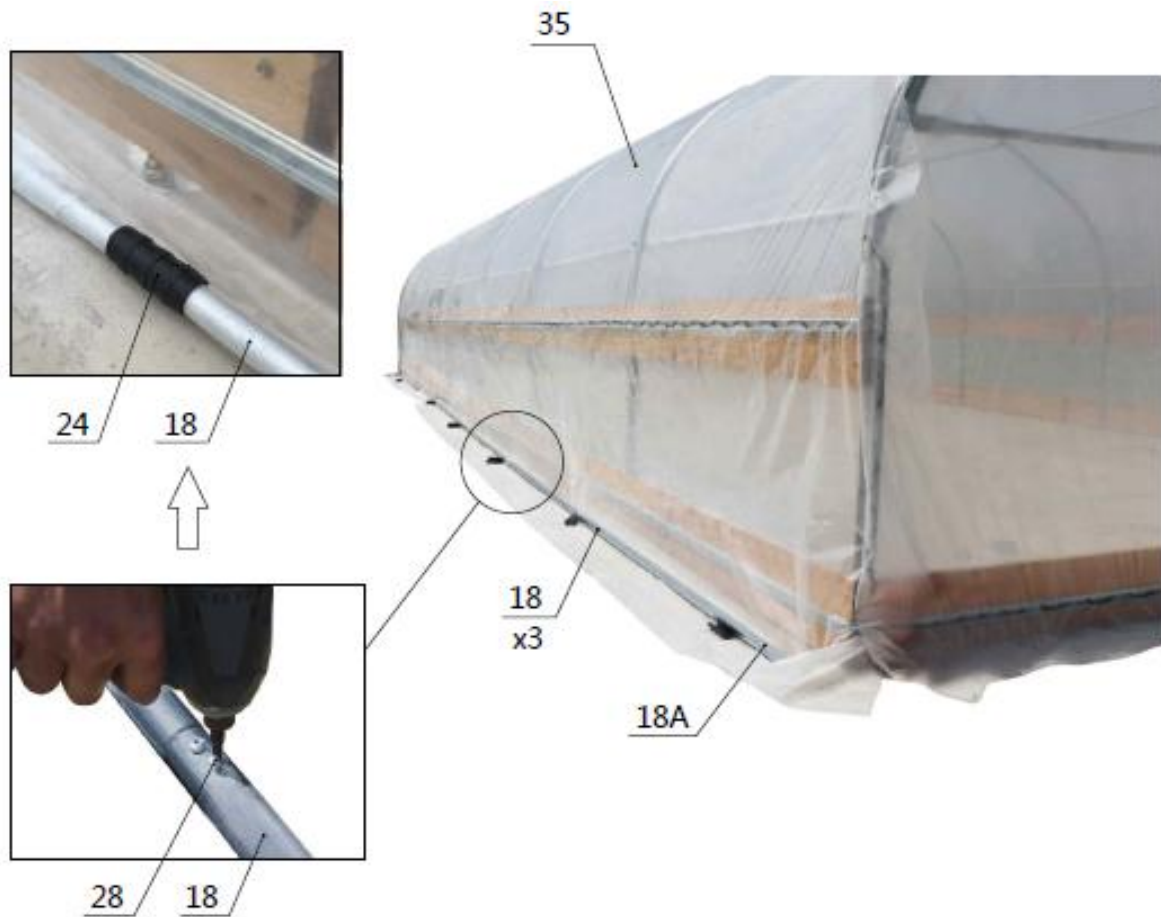

**STEP 7 : INSTALL ROLL FILM SYSTEM.**

- Install the roll film tube(#18), add a round plug(#32) at the end. the film (# 35) is wound on a roll film tube , and clamped with a pressure film carrier (# 24).







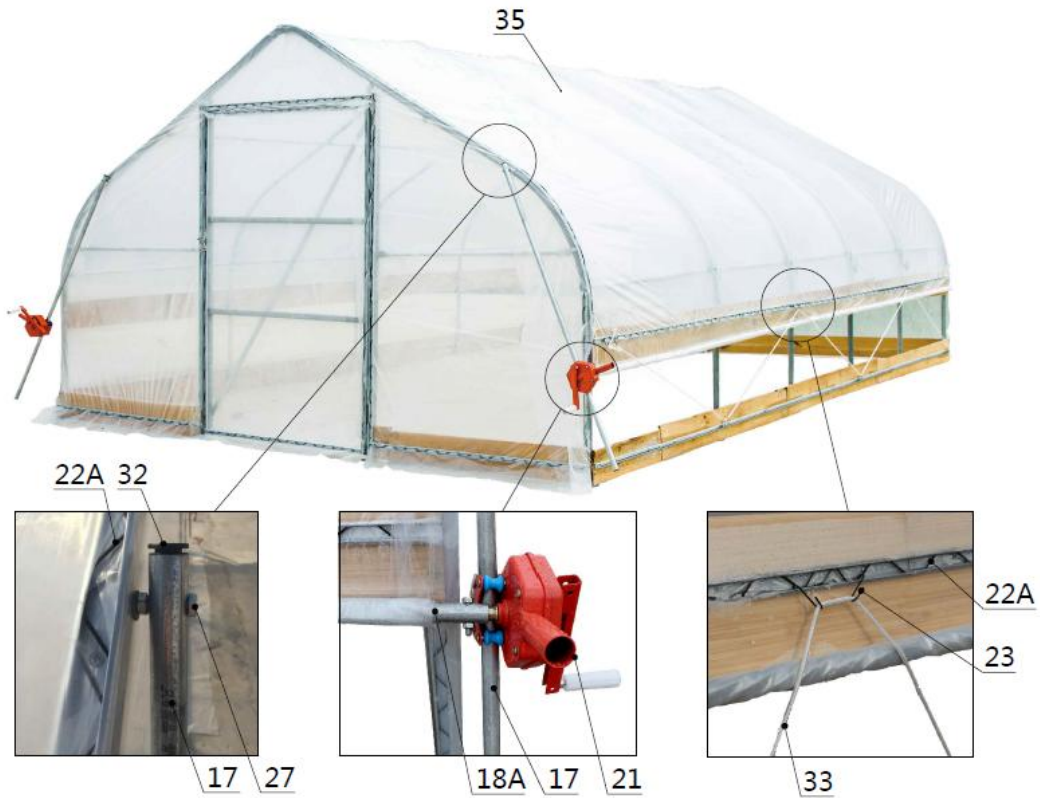

NO.	PART	QTY
18		6
18A		2
24		12

NO.	PART	QTY
28		12
32		2

- Around plug (# 32) is put on both ends of the film rolling machine guide tube (# 17), and the guide tube is mounted on the frame with a hex bolt (# 27), and it is required to swing freely. The film rolling machine (# 21) drives the roll film tube (# 18) to be raised and lowered horizontally and flexibly without jamming.
- Install the eight clip spring (# 23) and fasten the braided rope (# 33)



NO.	PART	QTY
17		2
21		2
23		12

NO.	PART	QTY
27		2
32		4
33		1

## **AFTER THE INSTALLATION**

Walk around and inspect the shelter periodically to make sure all components are still firmly secured and the whole shelter is well supported. Check all bolts and nuts as well as all connection points to make sure they are all in good position.

We strongly recommend you remove any snow from the roof immediately. Do not leave any snow load on the roof overnight. Keep 3 feet of clearance on all sides at all times. Do not allow snow to accumulate and pile up on the sides of the building. Otherwise the pressure from the sides will push inwards and could lead to a collapse.