

Steel Carport Front and Back Wall Package

Model: TMG-CP2000-RD110



- Please read the product manual completely before assembly
- Check against the parts list to make sure all parts are received
- Wear proper safety goggles or other protective gears while in assembly

Missing parts or questions on assembly?

Please call: 1-877-761-2819 or email: cs@tmgindustrial.com

Do not return the product to dealer, they are not equipped to handle your requests

Main Specifications :

- Overall assembled size : W6 x H3.78 (m) / 20 x 12 (ft)
- Width : 6 m / 20ft
- Ridge peak height : 3.78 m / 12 ft
- Shoulder wall clearance height : 3.0 m / 10 ft
- Roll-up door : W2.54 x H2.36 (m) / 100” x 93”
- Back door: W0.9 x H2.0 (m) / 36” x 78”

Prior to assembly

Please read the instructions carefully before installation. It is very important to follow your local safety regulations and industry standards during installation. Regulations may include but are not limited to:

- Safety helmets, protective eyewear, and clothing
- Safety harnesses for all elevated workers
- Proper ladder, cage, and safety operation









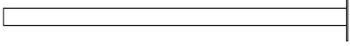

Check all components and parts before installation. All parts are marked with a part number, please refer to the parts list to make sure you have all parts.



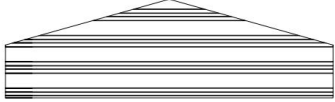

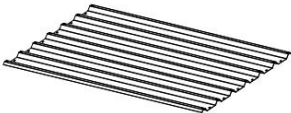

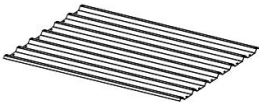

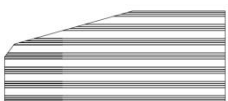
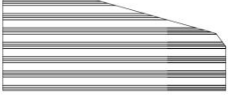



Choose a day with low or no wind to install, assembly is hard in heavy wind. Do not make any alterations to the structure. Do not hang any weights on the frame during installation, including parts. We are not responsible for any damages or injuries caused by inappropriate installation, unauthorized modifications or extreme weather.





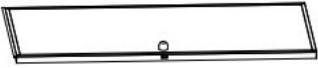
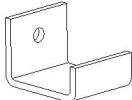
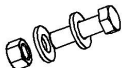

This building is not intended for human occupancy.

Read the following item list carefully and count the number of items to ensure that all parts are included prior to setup.

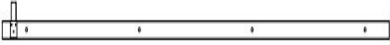
TMG-CP2000-RD110 Part List

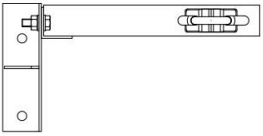
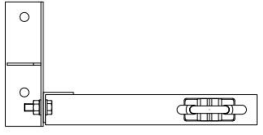
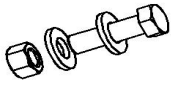
Parts code	Graphical	Description	length	Qty
4A		Short casing	198mm	4
4B		Lower vertical tube	2360mm	6
4C		Back door left tube	2360mm	1
4D		Back door right tube	2360mm	1
5		Baseplate	W150 x L200mm	8
7A		Metal sheet	W525 x L1760mm	2
7L		Metal sheet	W297 x L1076mm	2
7R		Metal sheet	W297 x L1076mm	2
8A		Metal sheet	W884 x L1760mm	2
8B		Metal sheet	W884 x L335mm	9
8C		Metal sheet	W884 x L1350mm	12
8D		Metal sheet	W410 x L1000mm	1
8L		Metal sheet	W884 x L2190mm	2
8R		Metal sheet	W884 x L2190mm	2

9A		Edge protector	1800mm	14
9B		Edge protector	2360mm	4
9C		Edge protector (h type)	2500mm	2
9D		Edge protector	2020mm	2
10		Edge buckle	200mm	12
12A		Front cross tube	1973mm	2
12B		Rear cross tube	1973mm	2
12C		Upper vertical tube	1065mm	4
13A		Front cross tube	1973mm	1
13B		Rear cross tube	1973mm	1
13C		Door frame cross pull tube	920mm	1
14A		Roll-up door	W400 x L2800mm	2
14B		Back door	W900 x L2000mm	1
14C		Limit block	W30 x L40mm	4
14D		Hex bolt	M6 x 20mm	4

14L		Front vertical door rail (left side)	L2400mm	2
14R		Front vertical door rail (right side)	L2400mm	2
15		Expansion bolt	φ16x150mm	16
15L		Right bracket assembly	W250 x L333mm	2
15R		Left bracket assembly	W250 x L333mm	2
17		Hex bolt	M10x70mm	62
18		Self tapping screw	#12x30mm	200
18A		Tapping screw	#12x25mm	24
22		Sleeve	41mm	2
24		Hole drill	85mm	1

Installation steps

Step 1 : Front truss installation

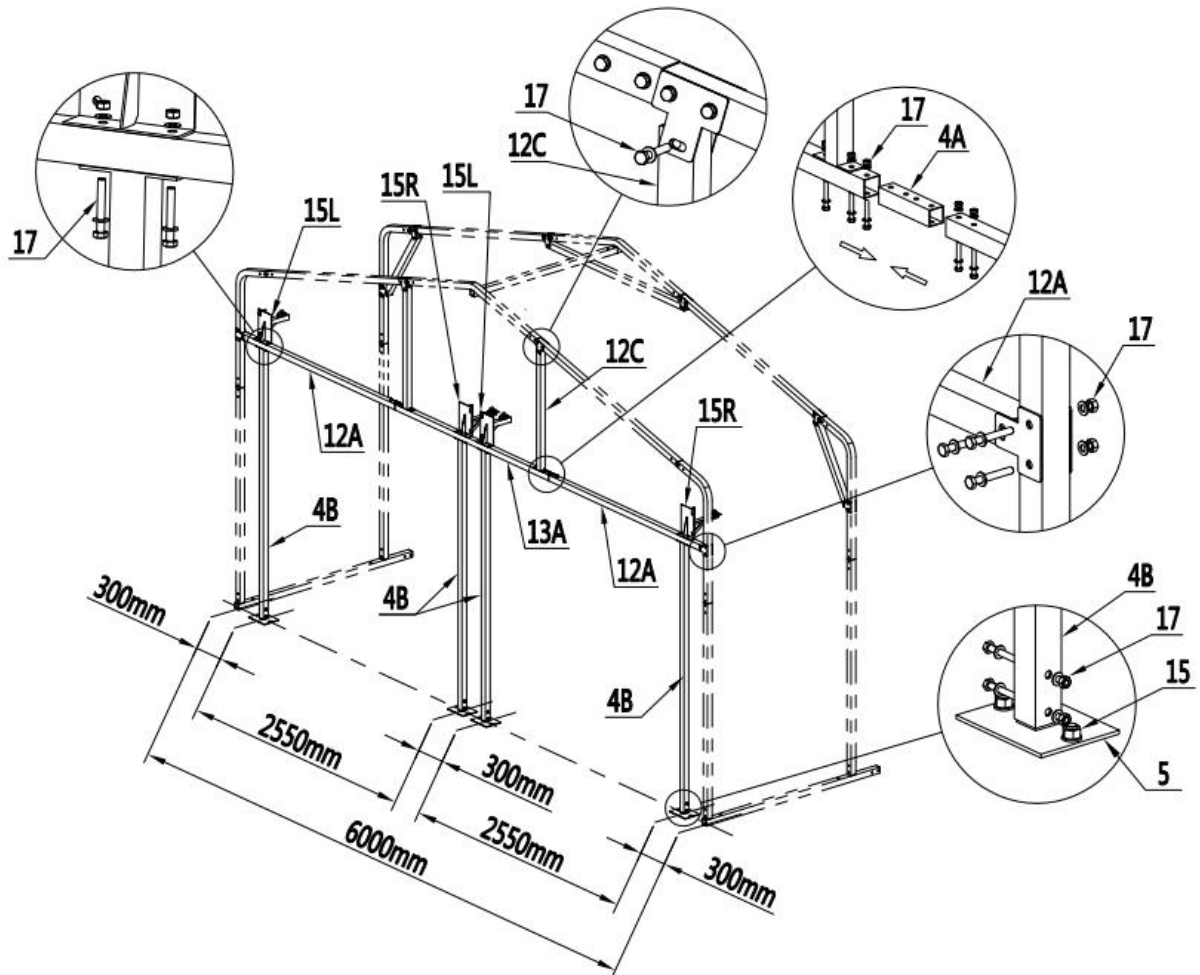







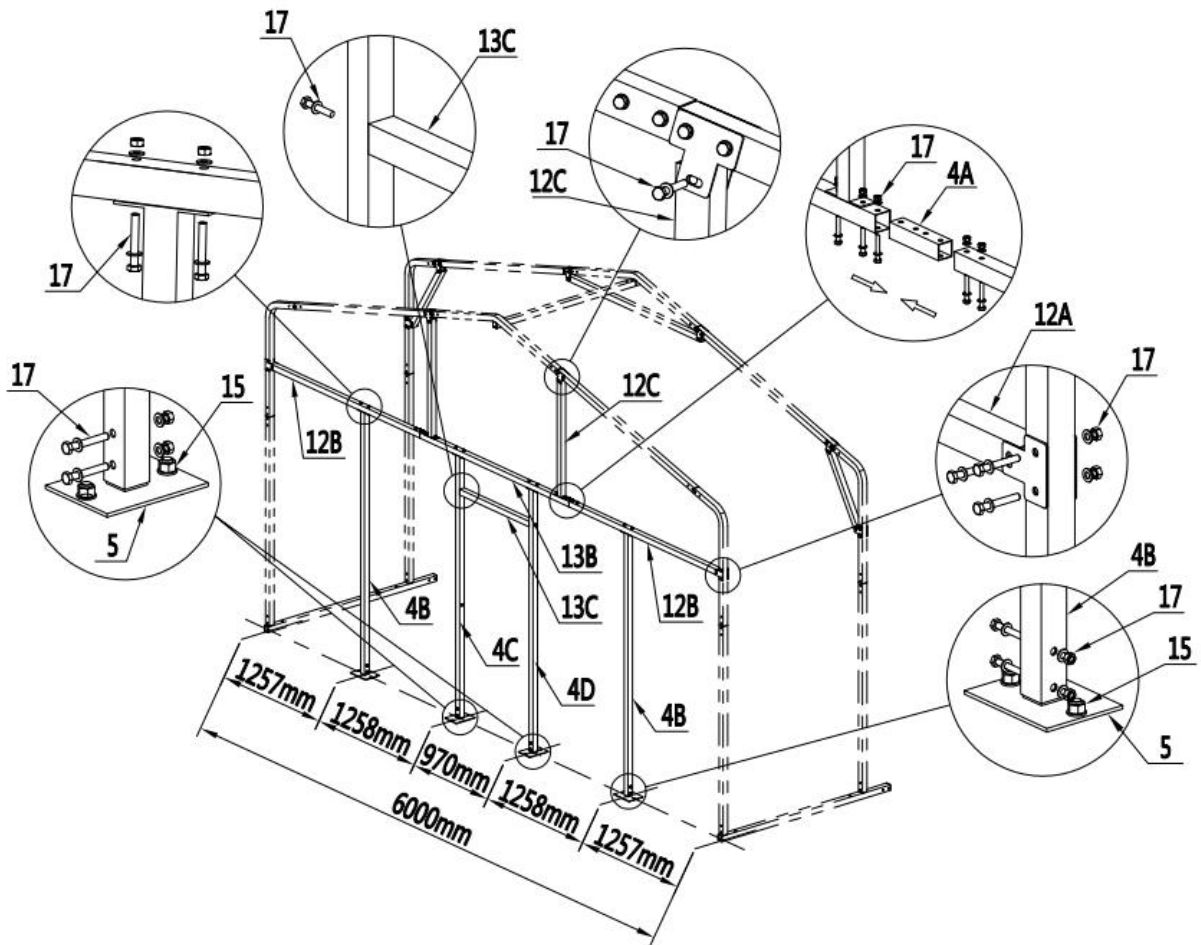

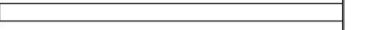
No.	Part	Qty
4A		2
4B		4
5		4
12A		2
12C		2
13A		1

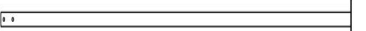
No.	Part	Qty
15L		2
15R		2
15		8
17		30

Step 2 : Rear truss installation

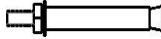
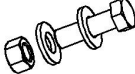

No.	Part	Qty
4A		2
4B		2
4C		1
4D		1
5		4
12B		2

No.	Part	Qty
12C		2
13B		1
13C		1
15		8
17		32



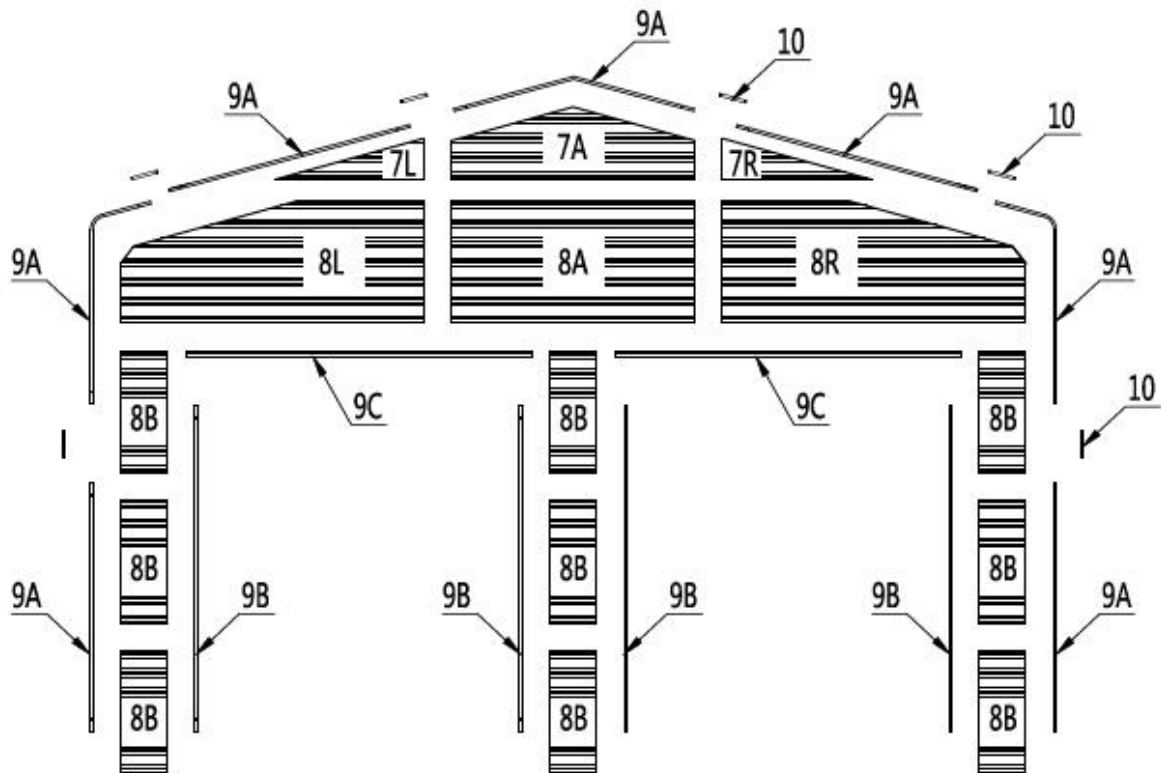

Step 3 : Install front wall panels



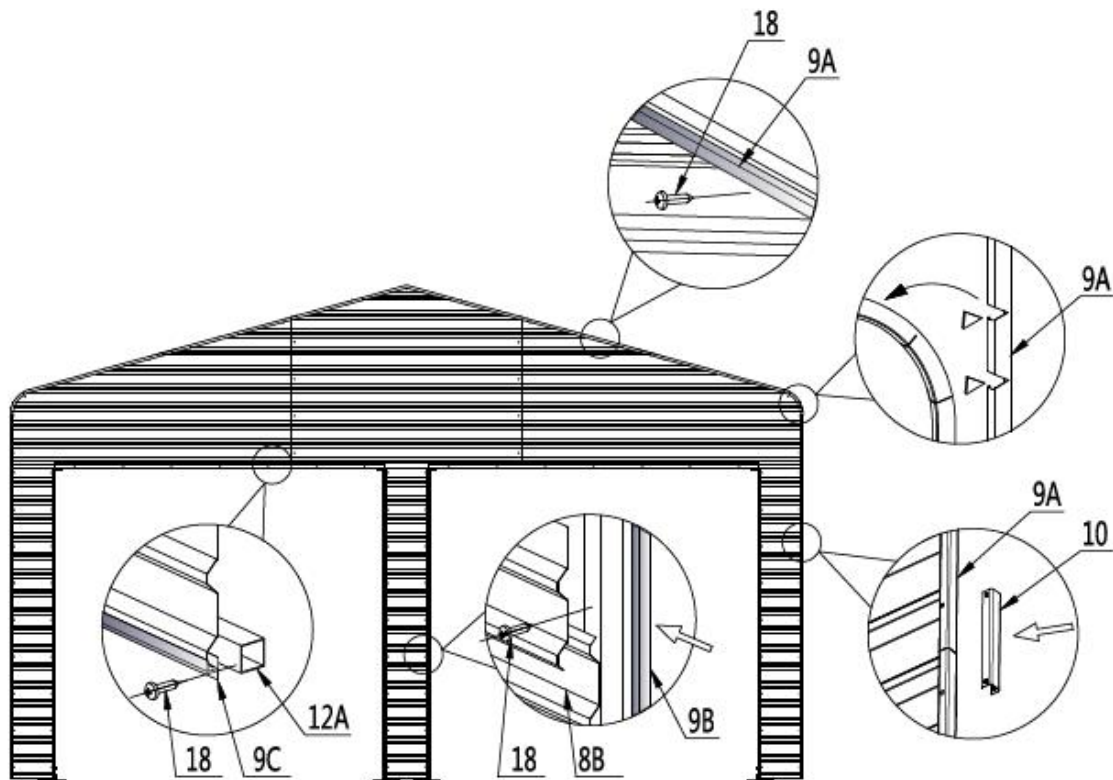

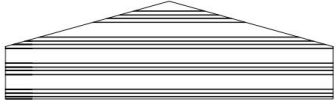

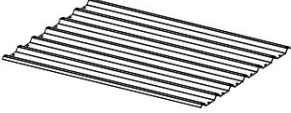
1. Wall panel placement order

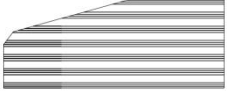

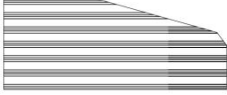
2. When installing the wall panel, install it from top to bottom.



No.	Part	Qty
7A		1
7L		1
7R		1
8A		1
8B		9
8L		1

No.	Part	Qty
8R		1
9A		7
9B		4
9C		2
10		6
18		100

Step 4 : Install rear wall panels

1. Wall panel placement order

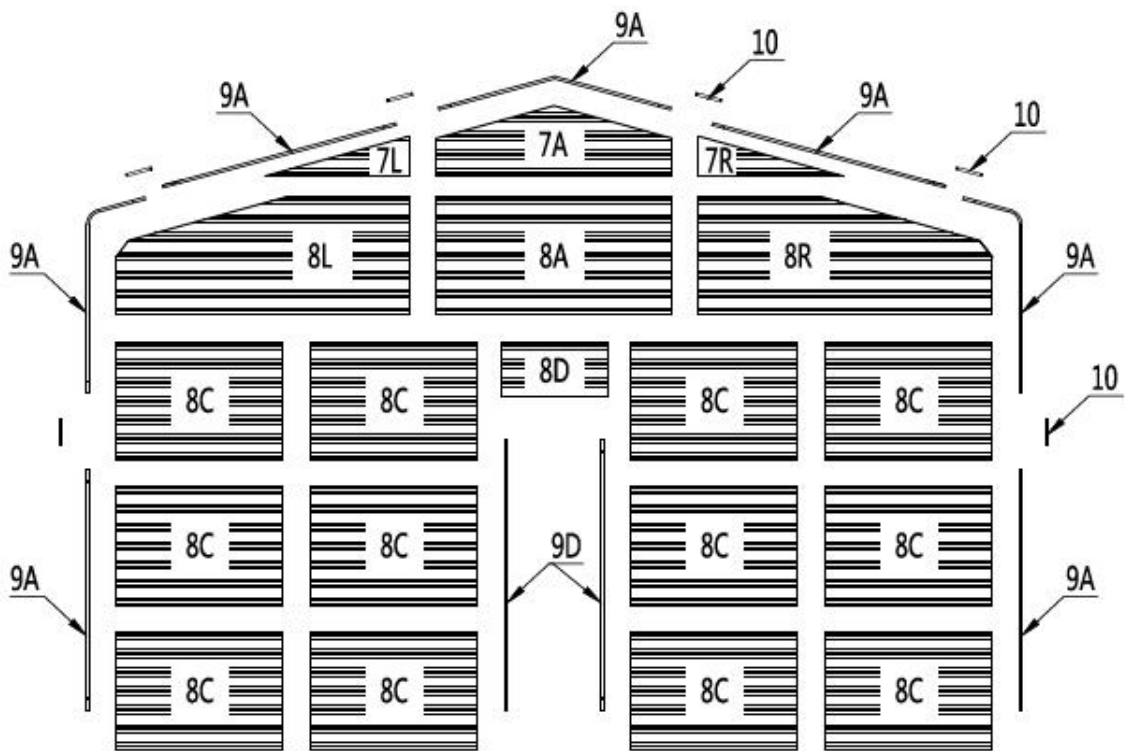

2. When installing the wall panel, install it from top to bottom

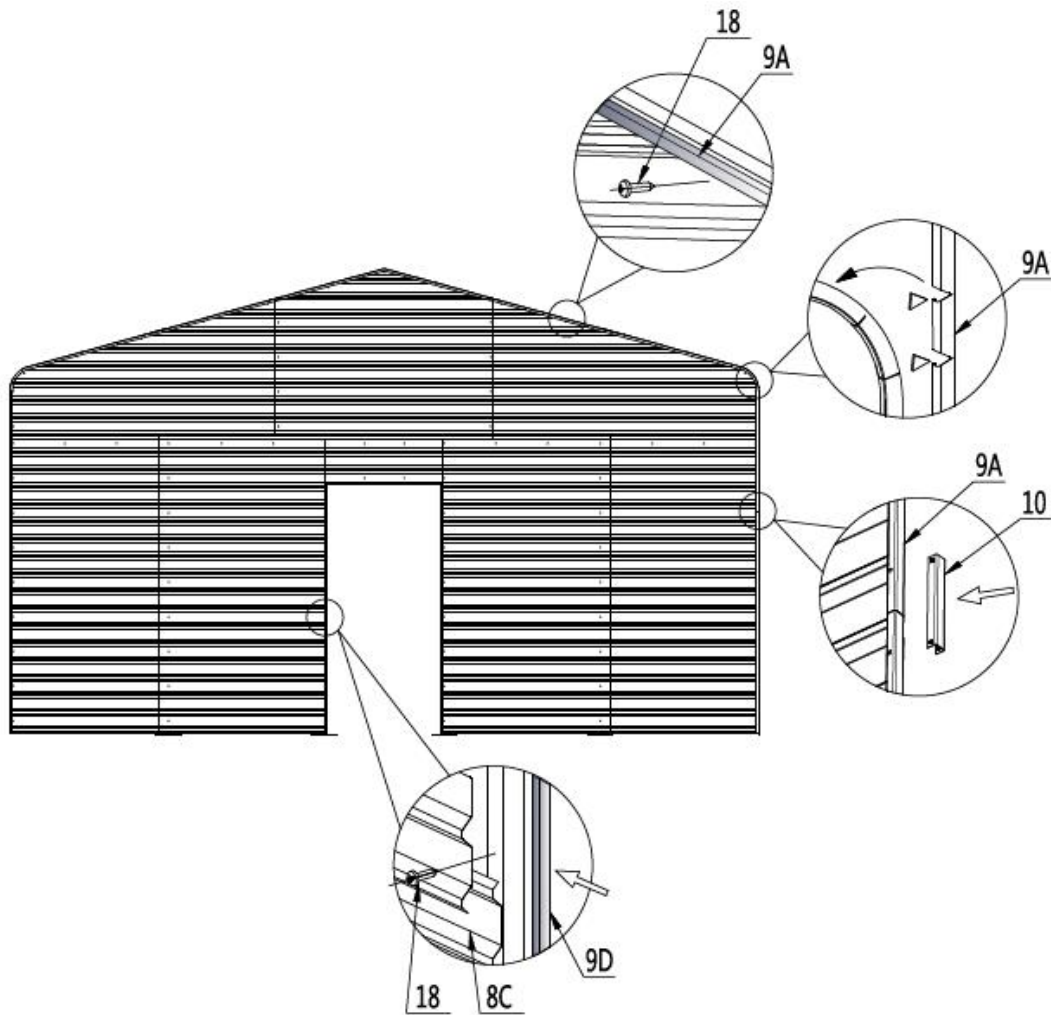

No.	Part	Qty
7A		1
7L		1
7R		1
8A		1
8C		12
8D		1





No.	Part	No.
8L		1
8R		1
9A		7
9D		2
10		6

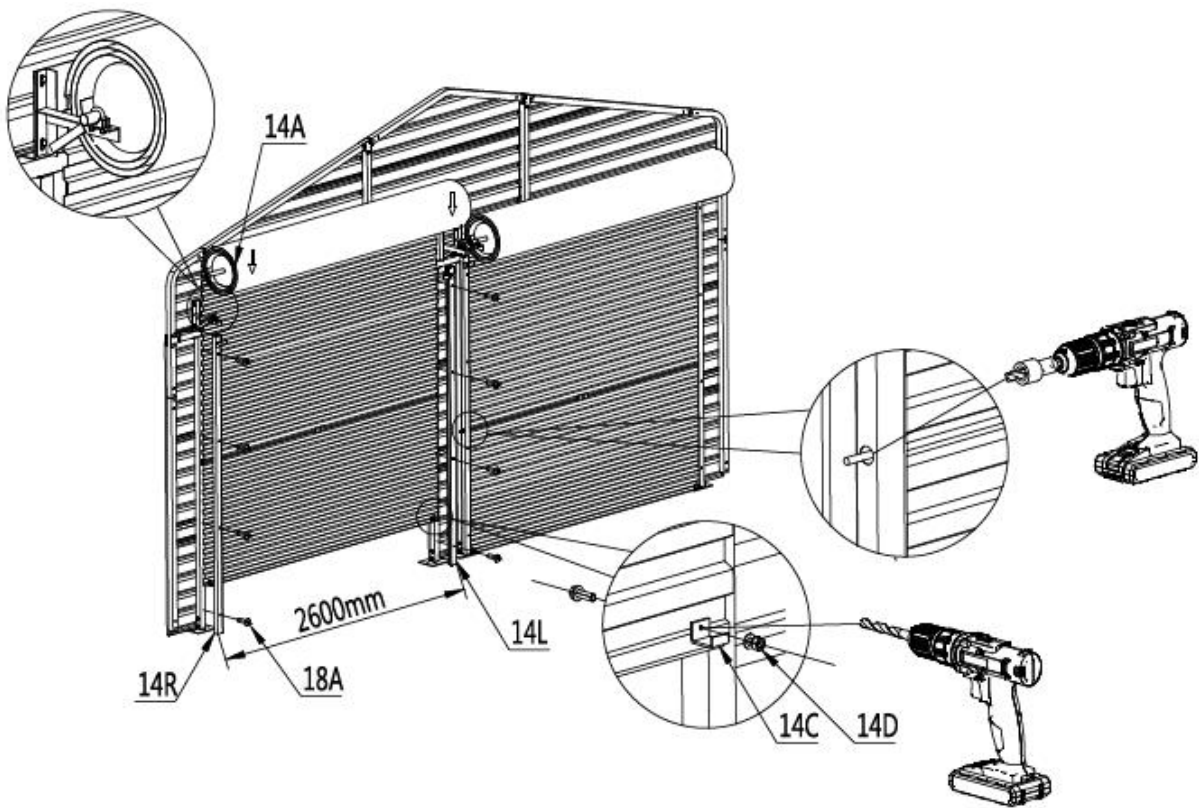

18A		100
-----	---	-----

Step 5 : Front door installation

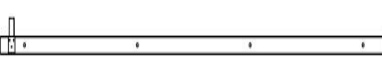
1. Install guide rail and roll-up door.
2. After adjusting the level of the rolling door and moving up and down flexibly, install the limit block (#14C).
3. The lock pin shaft has a hole in the proper position of the guide rail.



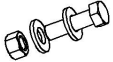

No.	Part	Qty
14A		2
14L		2
14R		2
14C		4

14D		4
18A		16
24		1

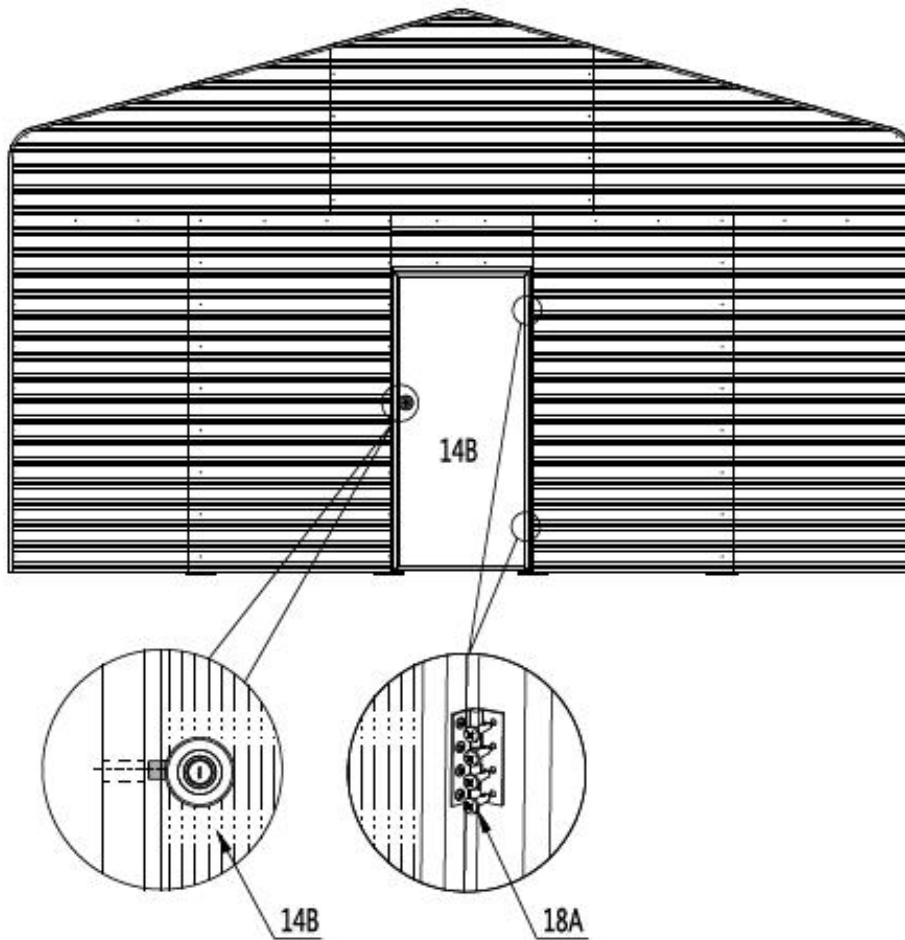
Step 6 : Rear door installation



No.	Part	Qty
14B		1
18A		8

After the Installation

Walk around and inspect the shelter periodically to make sure all components are still firmly secured and the whole shelter is well supported. Check all bolts and nuts as well as all connection points to make sure they are all in good position.

Snow accumulating on the fabric cover must be removed as soon as possible. If snow becomes solid ice on the cover, it will increase the weight on the roof and may collapse the shelter or reduce the life span.

We strongly recommend you remove any snow from the roof immediately. Do not leave any snow load on the roof overnight. Keep 3 feet of clearance on all sides at all times. Do not allow snow to accumulate and pile up on the sides of the building. Otherwise the pressure from the sides will push inwards and could lead to a collapse.