



(7043-7044 – 2013-2017) (7089-7090 - 2018-PRESENT) FORD TRANSIT, TOPO 2.0 FRONT SUSPENSION KIT

Version 1.8

General Notes

- For the most up to date and current instructions, please visit our website at www.vancompass.com
- Please read all instructions thoroughly before starting installing Van Compass products.
- This is a bolt on suspension package that can be installed with simple hand tools and removed at a later time to return the vehicle to stock configuration if desired.
- This suspension package provides anywhere from 1.75" to 2.0" of lift when using the factory strut. This variance is dependent on weight configurations of the vehicle.
- If installing a Bilstein strut with this suspension package, an additional .50" of lift will be achieved from the coil perch being welded onto the strut body at a taller height.
 - **DISCLAIMER:** Bilstein B6 Struts have a 7/8" longer strut shaft than the OEM strut and will cause binding of the passenger side (short side) CV shaft at full suspension droop. We cannot guarantee optimum CV life with this setup and do not recommend installing Bilstein struts with this lift kit on AWD models.
- The following instructions document the installation on a 2020 AWD Transit. Installation on older models and RWD models will be very similar.
- We recommend a maximum tire size of 265/75/16 tires with this lift kit. Any larger tire will contact the top of the inner fender when the suspension fully bottoms out. There are details regarding pinch seam trimming for tire clearance at the end of these instructions.

Parts List

1039 – 2018-PRESENT, FORD TRANSIT, FRONT STRUT SPACER, 3/4" LIFT SPACER

- | | |
|-------------------------|--|
| • (1) 103901-L | FRONT BILLET STRUT SPACER, LEFT HAND SIDE |
| • (1) 103901-R | FRONT BILLET STRUT SPACER, RIGHT HAND SIDE |
| • (2) 102902 | SWAY BAR LINK RELOCATION TAB |
| • (12) NSM10-1.50 | M10-1.50 STOVER NUT, CLEAR ZINC PLATE |
| • (6) WFM10 | M10 FLAT WASHER |
| • (2) HM12-1.50-25-10.9 | M12-1.50 X 25MM LONG, HEX HEAD BOLT |
| • (2) NNM12-1.50 | M12-1.50 NYLOCK NUT |
| • (4) WFM12 | M12 FLAT WASHER |

OR

1042 – 2013-2017, FORD TRANSIT, FRONT STRUT SPACER, 3/4" LIFT SPACER

- | | |
|----------------|--|
| • (1) 104201-L | FRONT BILLET STRUT SPACER, LEFT HAND SIDE |
| • (1) 104201-R | FRONT BILLET STRUT SPACER, RIGHT HAND SIDE |

- (2) 102902 SWAY BAR LINK RELOCATION TAB
- (6) NSM8-1.25 M8-1.25 STOVER NUT, CLEAR ZINC PLATE
- (6) WFM8 M8 FLAT WASHER
- (2) HM12-1.50-25-10.9 M12-1.50 X 25MM LONG, HEX HEAD BOLT
- (2) NNM12-1.50 M12-1.50 NYLOCK NUT
- (4) WFM12 M12 FLAT WASHER

1030 / 1031 – 2013-PRESENT, FORD TRANSIT, FRONT 1.0” LIFT SPRING

- (2) 1030 FORD TRANSIT, FRONT 1.0” LIFT SPRING (FACTORY RATE)

Tools Needed

- One quality floor jack and 2 jack stands.
 - Optional – Automobile lift, one transmission jack, and two screw jacks.
- 4-1/2” angle grinder with metal cutting cut off wheel. (Or similar cutting device to cut studs)
- Coil Spring Compressor (Macpherson Strut Style)
- Simple hand tools:
 - Torque Wrench
 - Hammer, dead blow, pry bar
 - Basic wrench and socket set:
 - Metric sizes: 8mm, 10mm, 13mm, 15mm, 17-18mm, 21mm, 24mm, 30mm, 36mm
 - 6mm allen

Approximate Installation Time

- Professional shop with automotive lift: 5-6 hours
- Driveway install with jack and jack stands: 7-8 hours

Installation

- 1) Lift the vehicle using a vehicle lift or a floor jack to safely support it on jackstands. Be sure that the entirety of the front suspension sub frame is not supported and can be lowered away from the main chassis of the vehicle. We recommend supporting the vehicle just behind the transmission cross member as shown in the image below.
- 2) Note the installation of this suspension package kit can be done simultaneously on both the left and right sides of the vehicle. Complete steps on both sides of the vehicle unless otherwise specified.

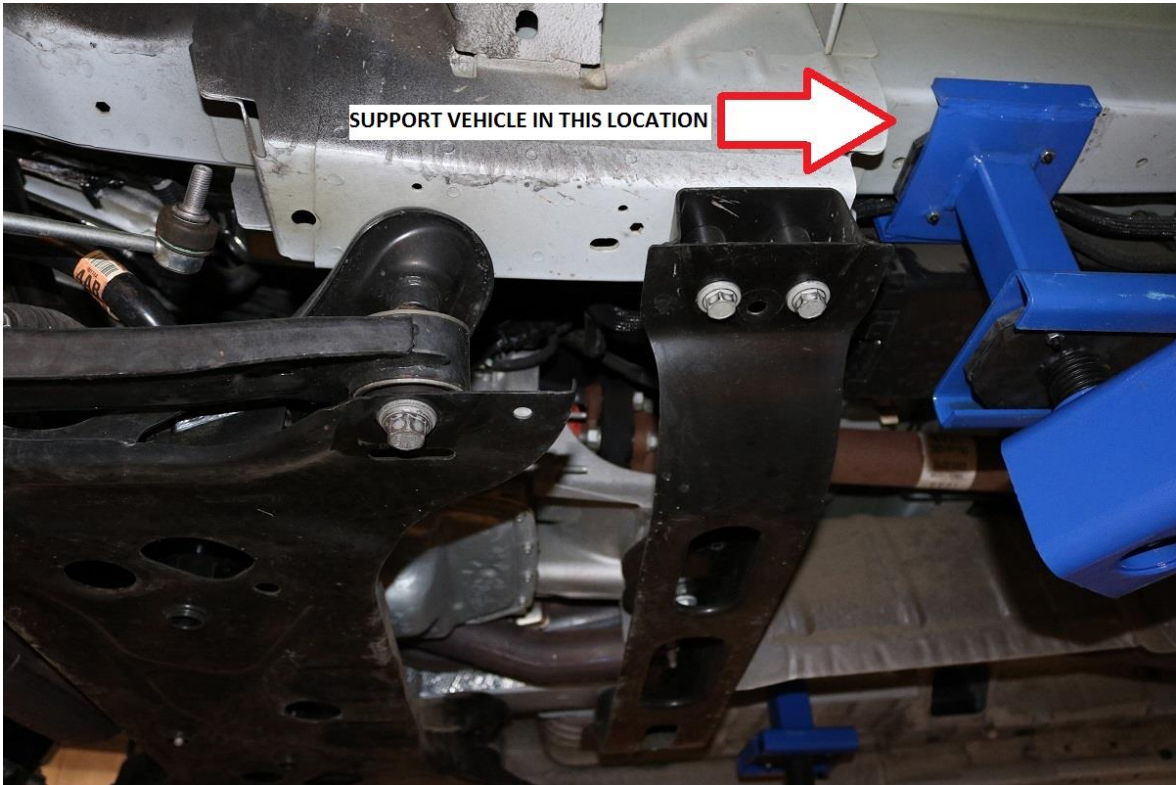

- 3) With the vehicle safely raised so the front suspension is completely unloaded, remove the front wheels / tires.
- 4) Remove the tie rod end at the steering knuckle. Use a 21mm socket / wrench for removal. A tie rod end puller or pickle fork may be used to separate the tie rod end from the steering knuckle. Alternatively, a couple firm blows with a 5lb sledge to the steering knuckle will often easily break the taper free.

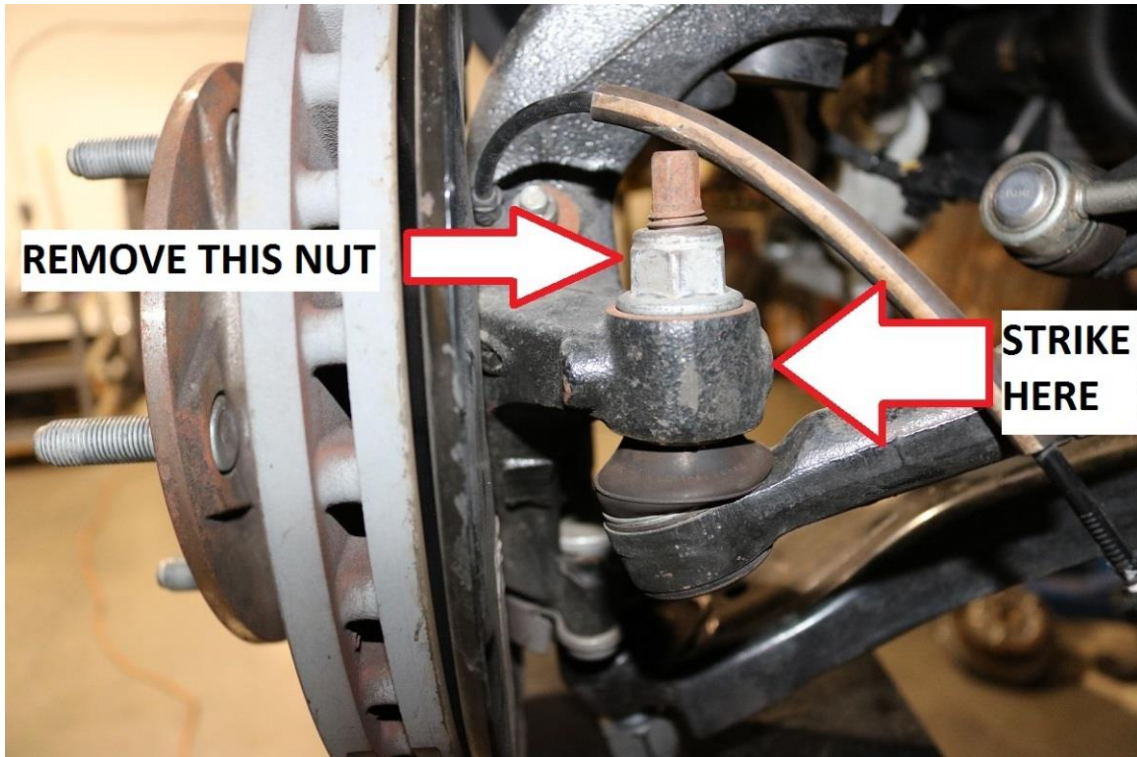

- 5) Use a 21mm socket / wrench to remove the brake caliper adapter bolts at the steering knuckle. There are two bolts per caliper.
 - a. Secure the brake caliper out of the way, forward of the front suspension. Do not allow the caliper to hang by the brake hose.

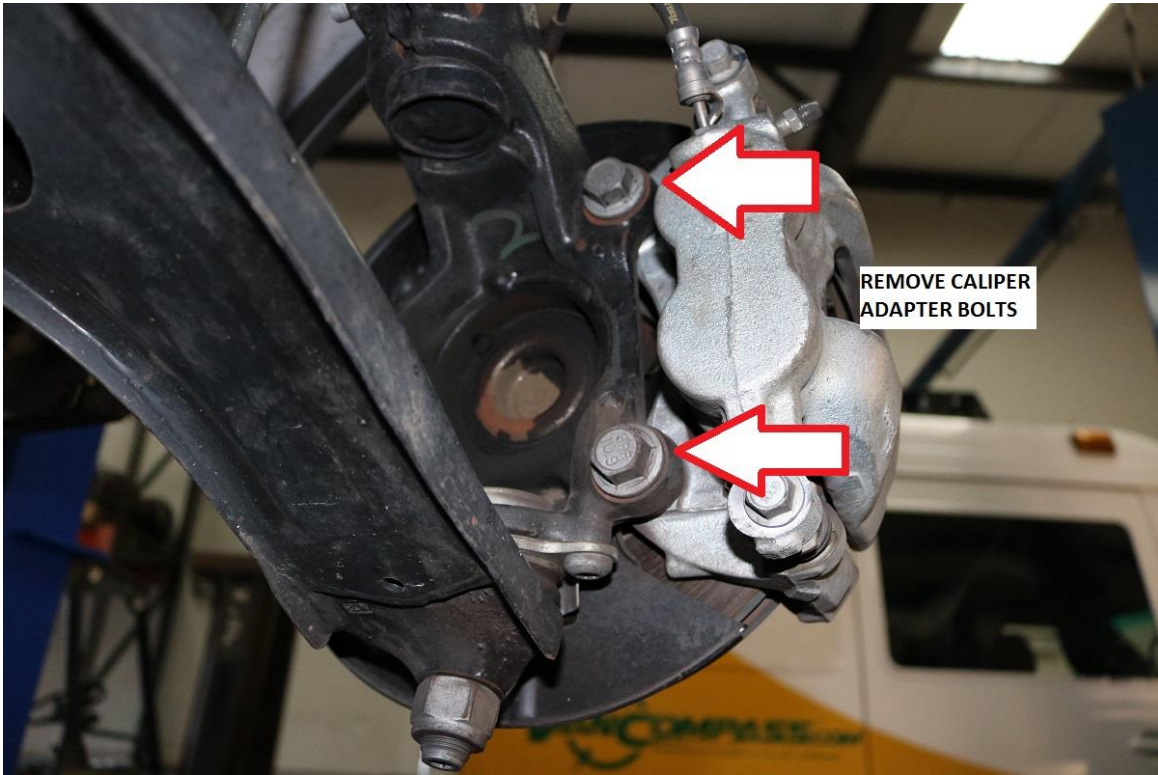

- 6) Disconnect the sway bar end link from the strut. Use an 18mm wrench and 6mm allen to remove the nut from the sway bar end link stud.

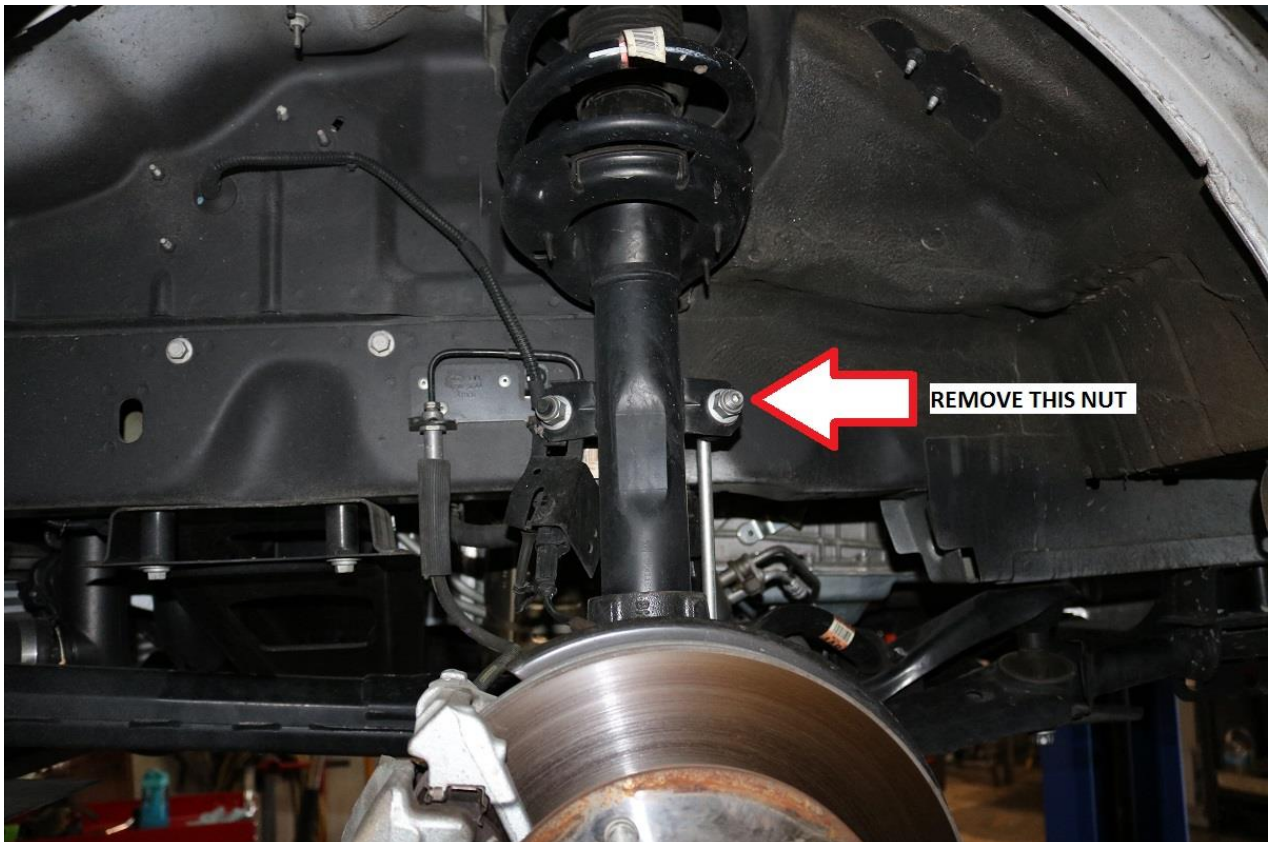

7) Remove the wheel speed sensor wiring from the strut. See image below for reference.

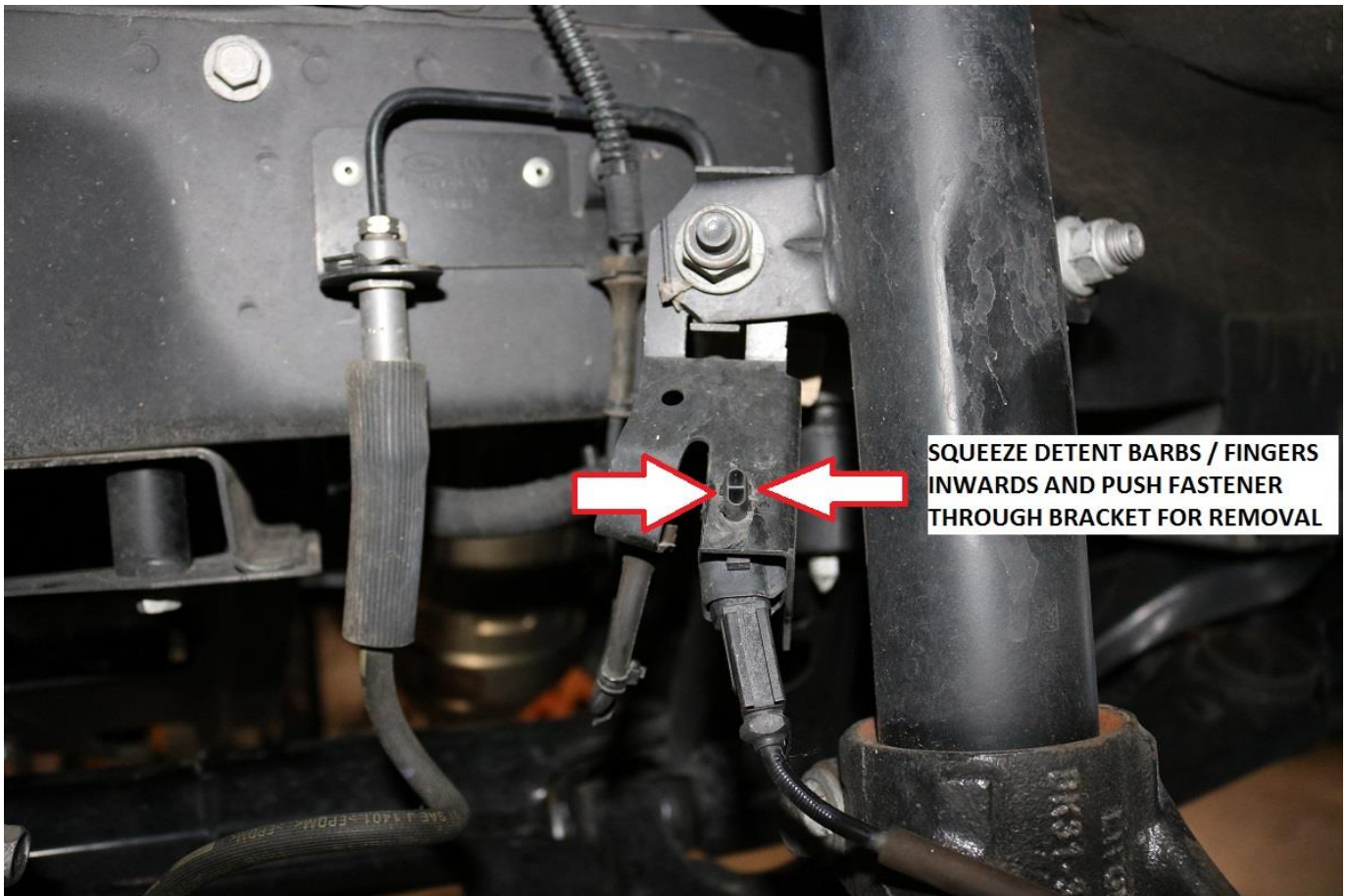

8) Completely remove the wheel speed sensor wiring from the strut. Separate the wheel speed sensor from the chassis harness. See image below for reference.

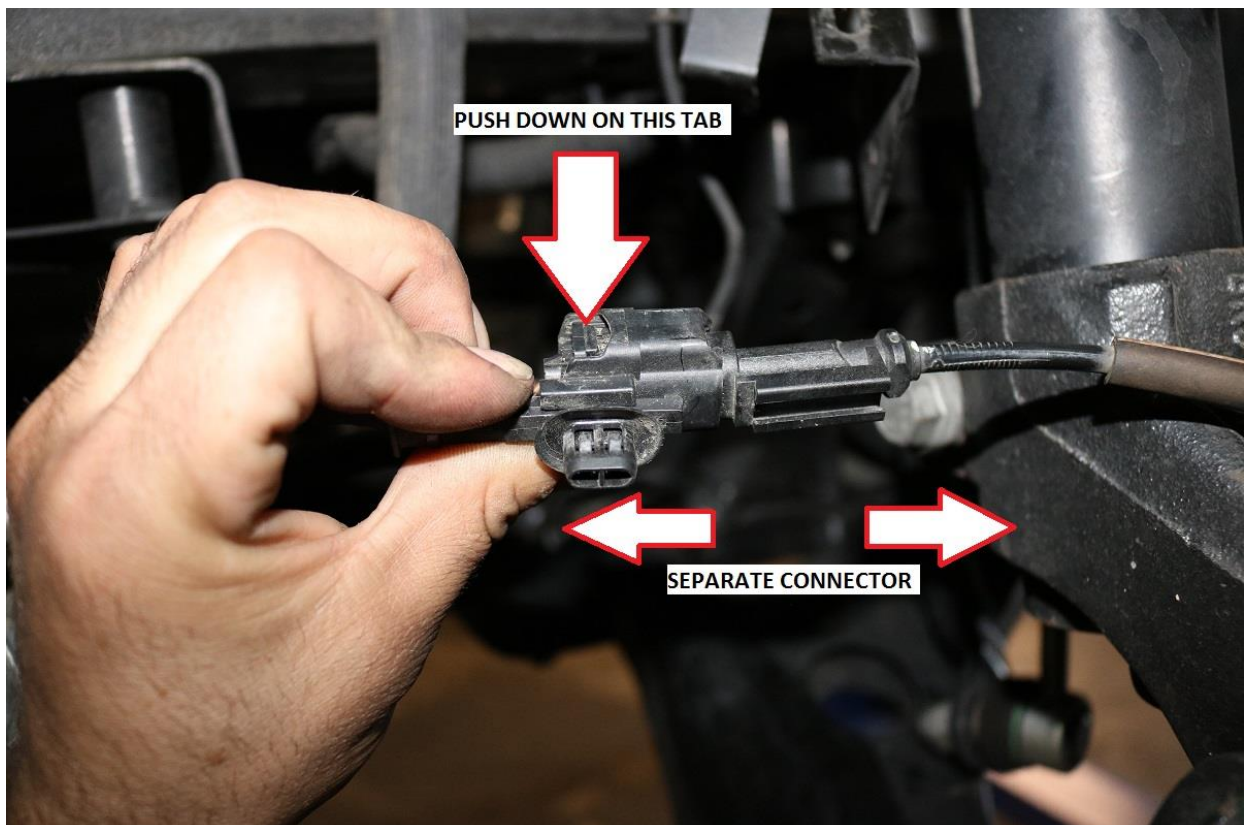

- 9) On AWD models, remove the front axle nut. Use a 36mm socket for removal.
- a. Once the nut is removed, use a rubber mallet or dead blow to knock the CV shaft inwards. Just make sure it will easily slide in and out of the hub at this time.

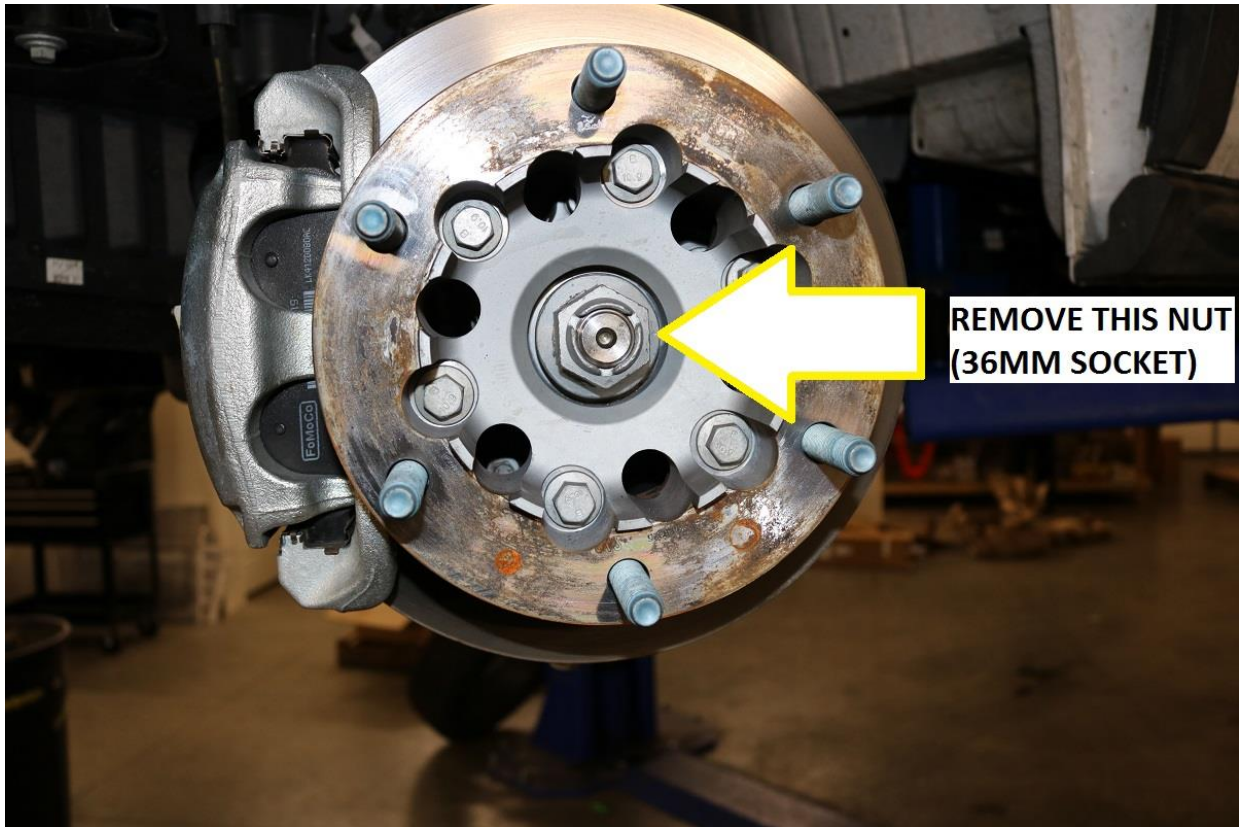

- 10) Loosen the lower strut bolt which secures the strut to the steering knuckle. Use an 18mm socket / wrench to loosen the bolt. See image below for reference.

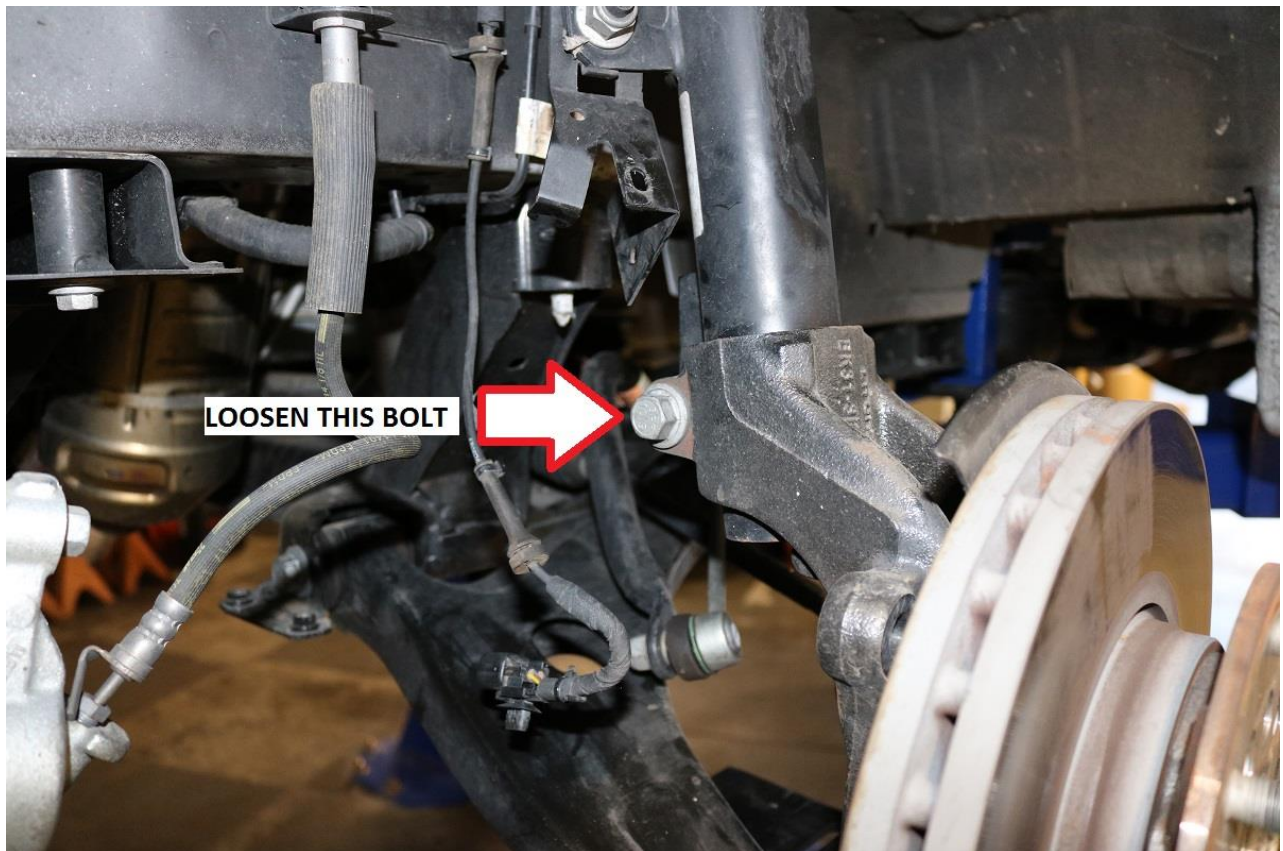

- 11) Remove the lower ball joint nut using a 30mm socket. Once removed, separate the taper of the ball joint stud from the lower control arm.
- Again, a tie rod end puller or pickle fork may be used to separate the tie rod end from the steering knuckle. However, a couple firm blows with a 5lb sledge to the lower control arm will often easily break the taper free without damaging the dust boot.

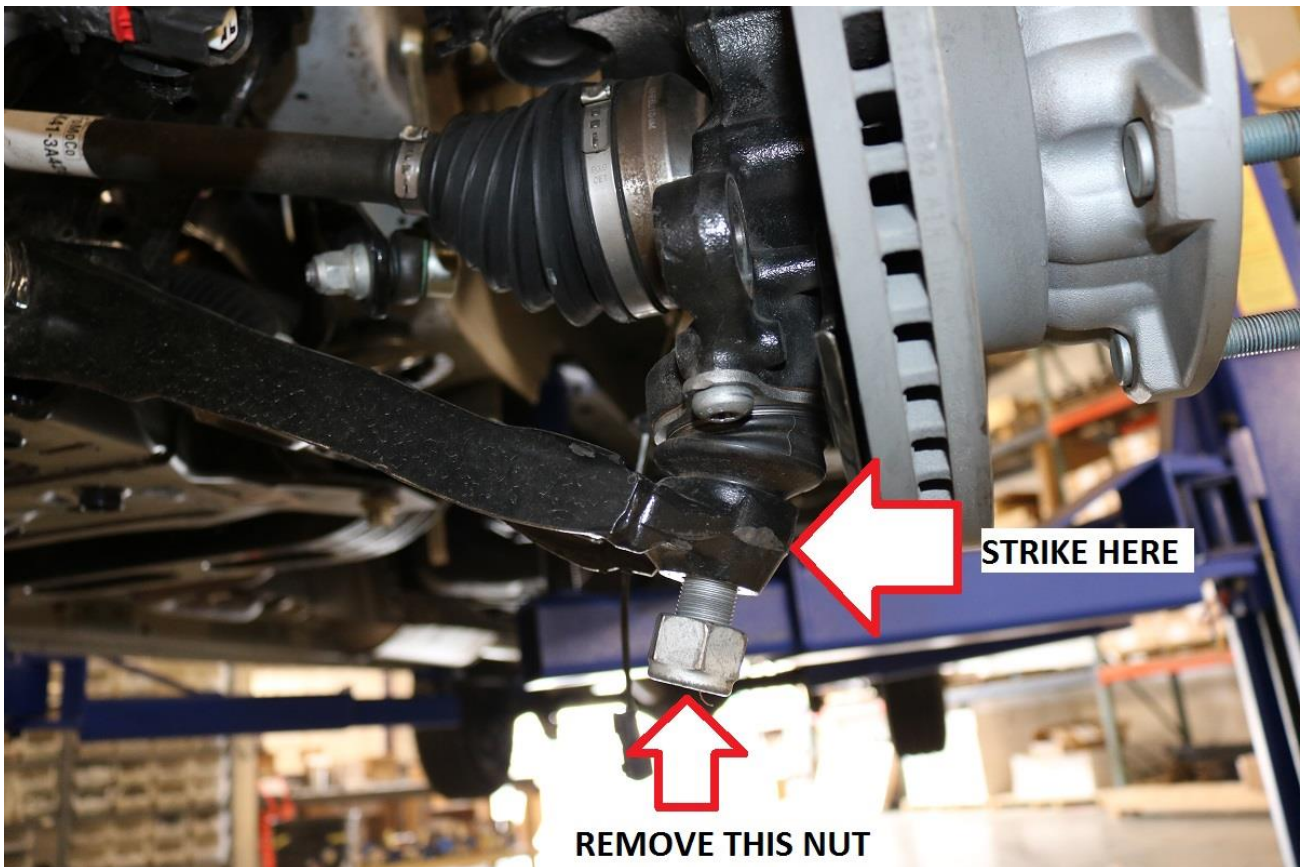

- 12) With the lower ball joint taper broken free from the lower control arm, use a long pry bar or similar tool to pry the lower control arm down enough to pull the bottom of the strut / steering knuckle clear of the lower control arm.
- There is large hole in the lower control arm near the sway bar which works as a good pry point. Be careful not to pry too heavily and bend the lower control arm. Just pry the arm downwards to the point where the stud of the lower ball joint can clear the control arm.
 - Be careful not to damage the boot of the lower ball joint once it is free from the lower control arm.

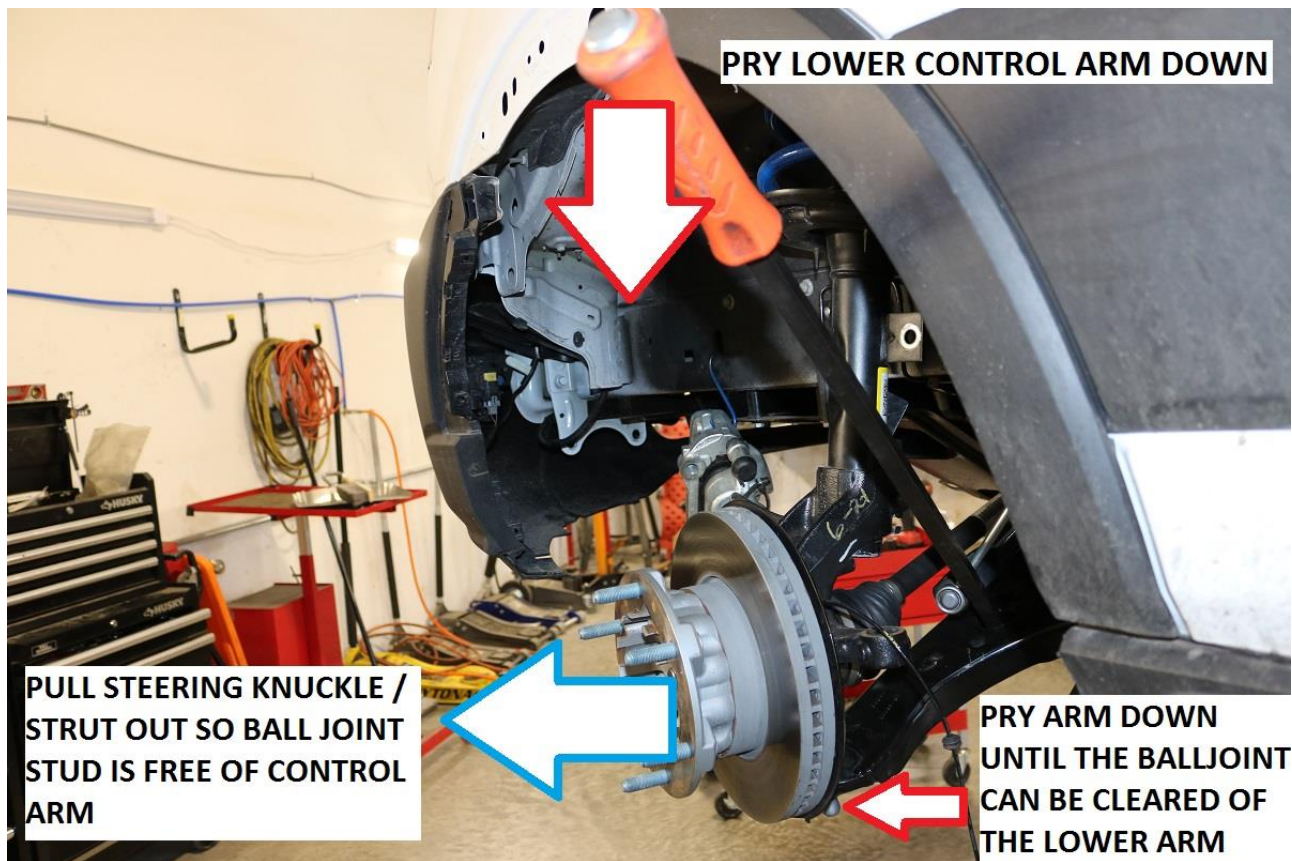

- 13) On AWD models, turn the steering knuckle to full steering lock and pull the wheel / hub outwards to remove the CV shaft from the hub.
- Note; to prevent the CV shafts from overextending and potentially coming apart, do not let them hang at full bind. Use a ratchet strap or similar tool to hold them in a reasonable position.

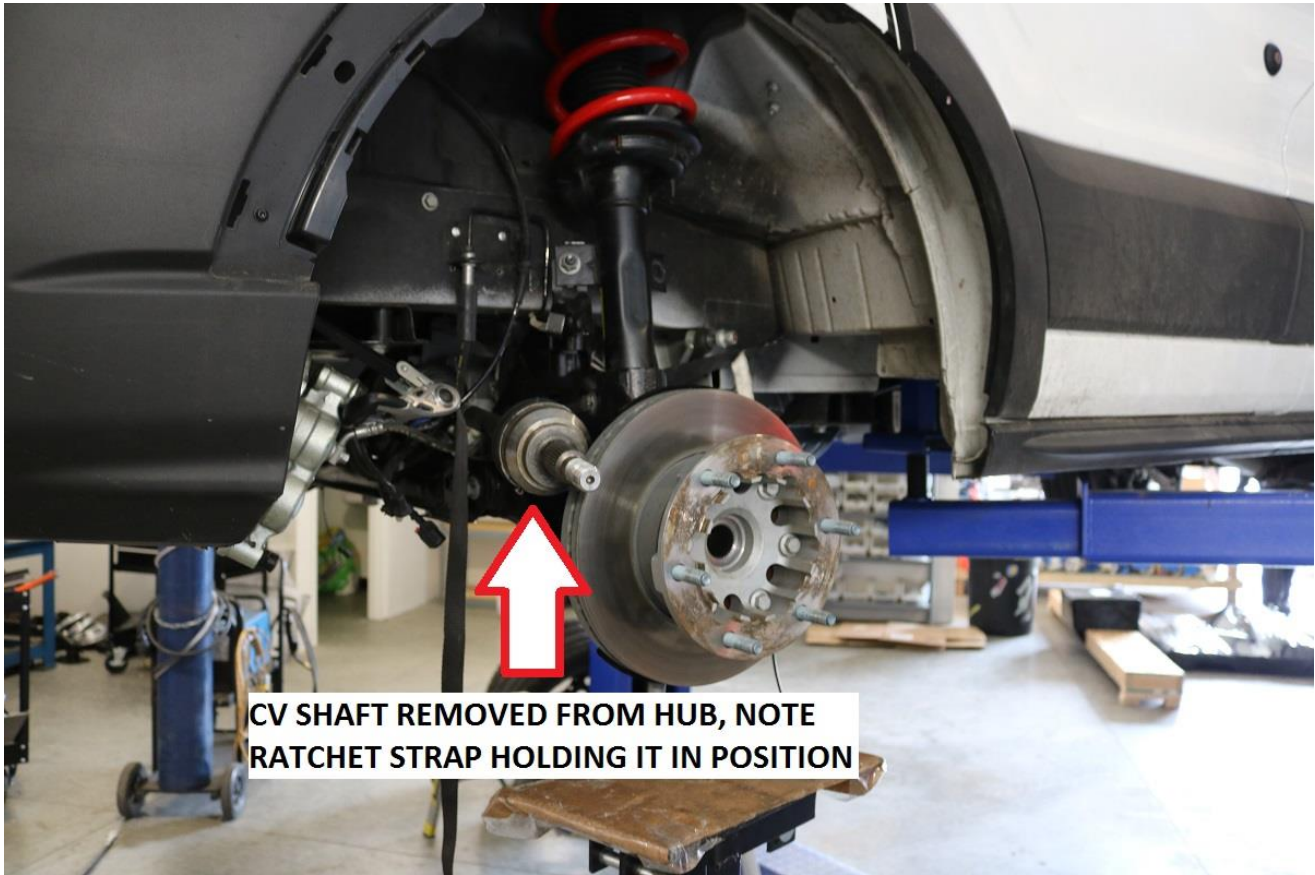

- 14) With the CV free from the hub, support the steering knuckle with a transmission or floor jack and remove the 18mm lower strut bolt. Remove the steering knuckle from the strut and set it aside.



- 15) Remove the three upper strut nuts securing the strut to the chassis. Use a 15mm socket / wrench for removal (13mm for 2013-2017). On the driver (left hand) side of the vehicle, the nuts are accessible via the driver foot well.

- a. Note; the factory service manual recommends disassembly of several dash components to gain access to the upper strut mounting nuts. We have found this to be unnecessary as the strut nuts can be accessed without dash disassembly.
- b. Pull the top of the rubber floor covering away to gain access to the strut mounting nuts. See images below for reference.

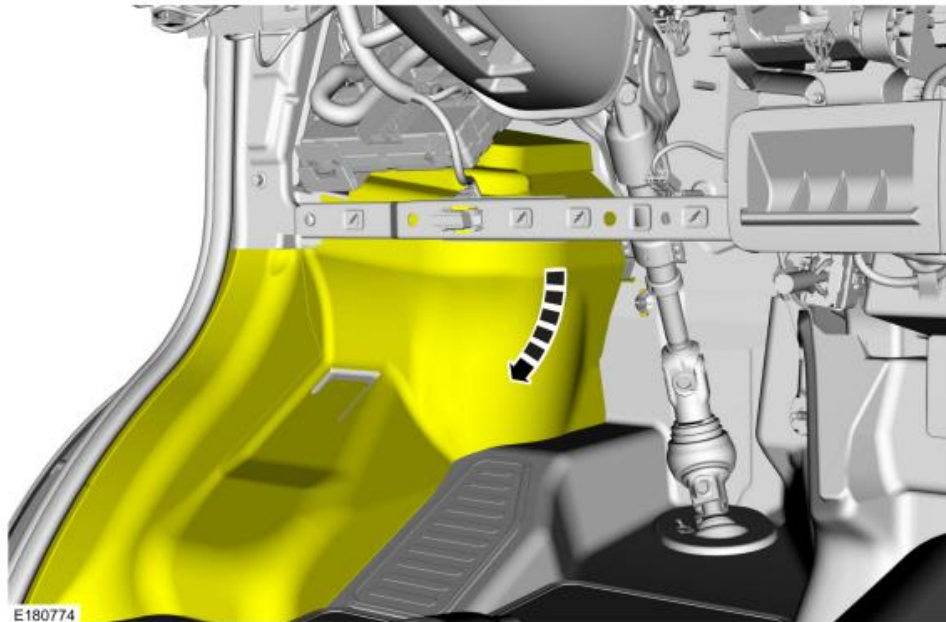

- 16) Have a helper support / stabilize the strut in preparation for removal of the strut's upper mounting nuts.
 - a. Remove the strut from the vehicle. If re-installing the factory struts, label what side of the vehicle the strut was removed from.
- 17) On the passenger (right hand) side of the vehicle. Access to the upper strut mounting nuts can be achieved by lowering the glove box.

- a. Open the glove box and push the stop tabs downward to fully lower the glove box.
 - i. Note; on 2020+ models sides of the glove box need to be pushed inwards for it to rotate downward.

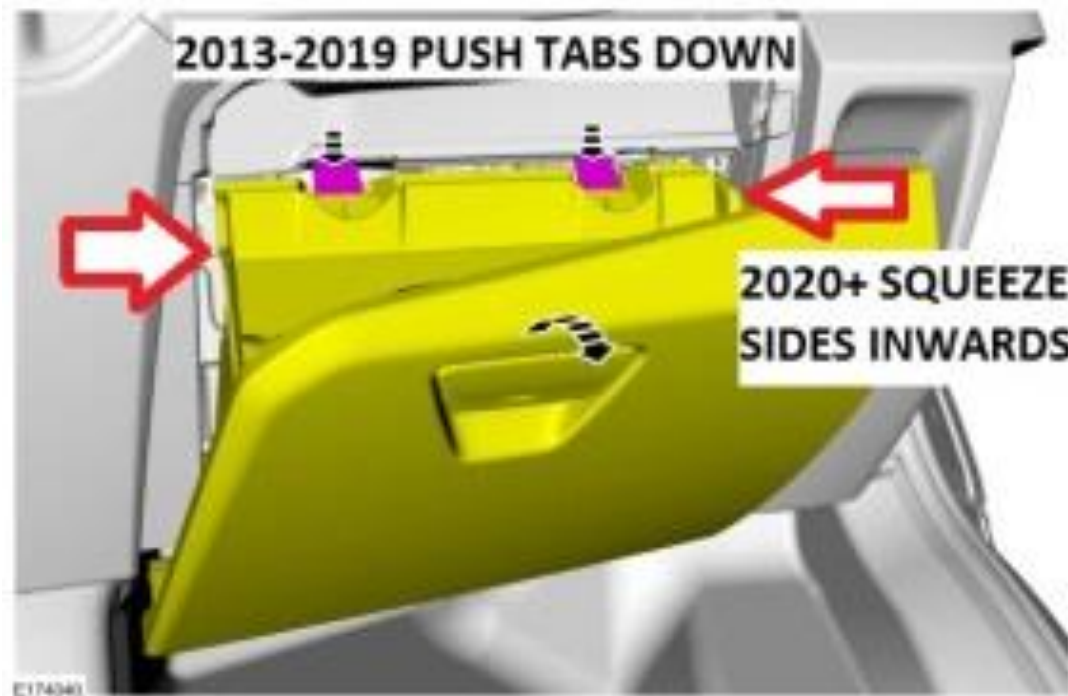

- 18) With the glove box lowered, pull the rubber floor covering away to gain access to the upper mounting nuts of the strut. See images below for reference.

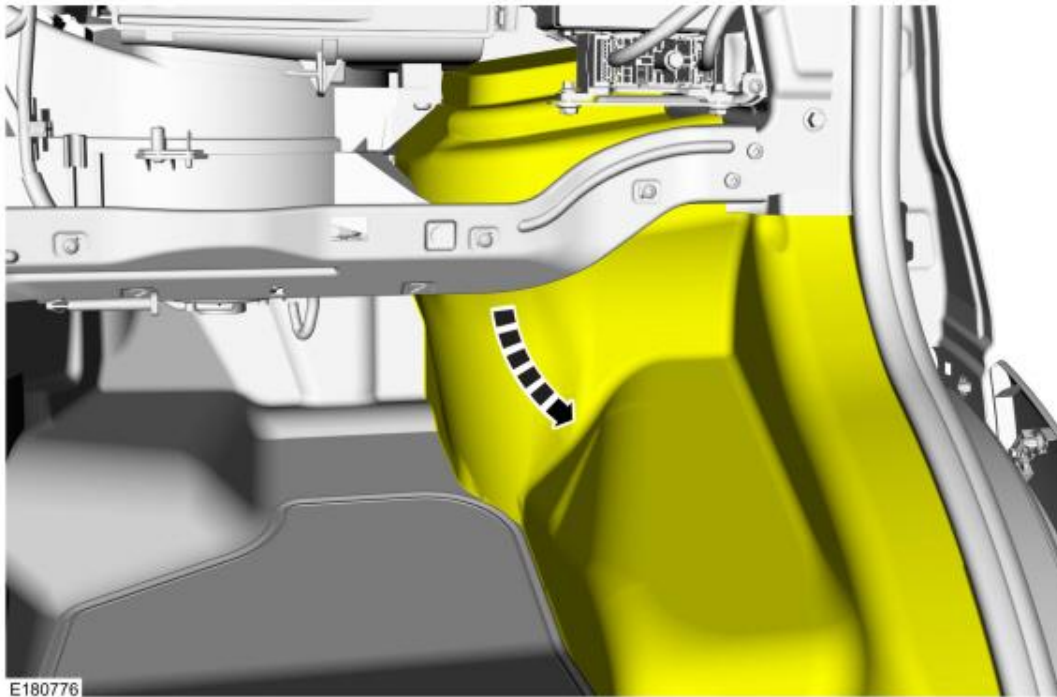

- 19) Again, have a helper support the strut in preparation for removal of the strut's upper mounting nuts.
- a. Remove the strut upper mounting nuts using a 15mm socket / wrench. (13mm for 2013-2017)
 - b. Remove the strut from the vehicle; again, label what side of the vehicle it was removed from if re-installing the factory struts.

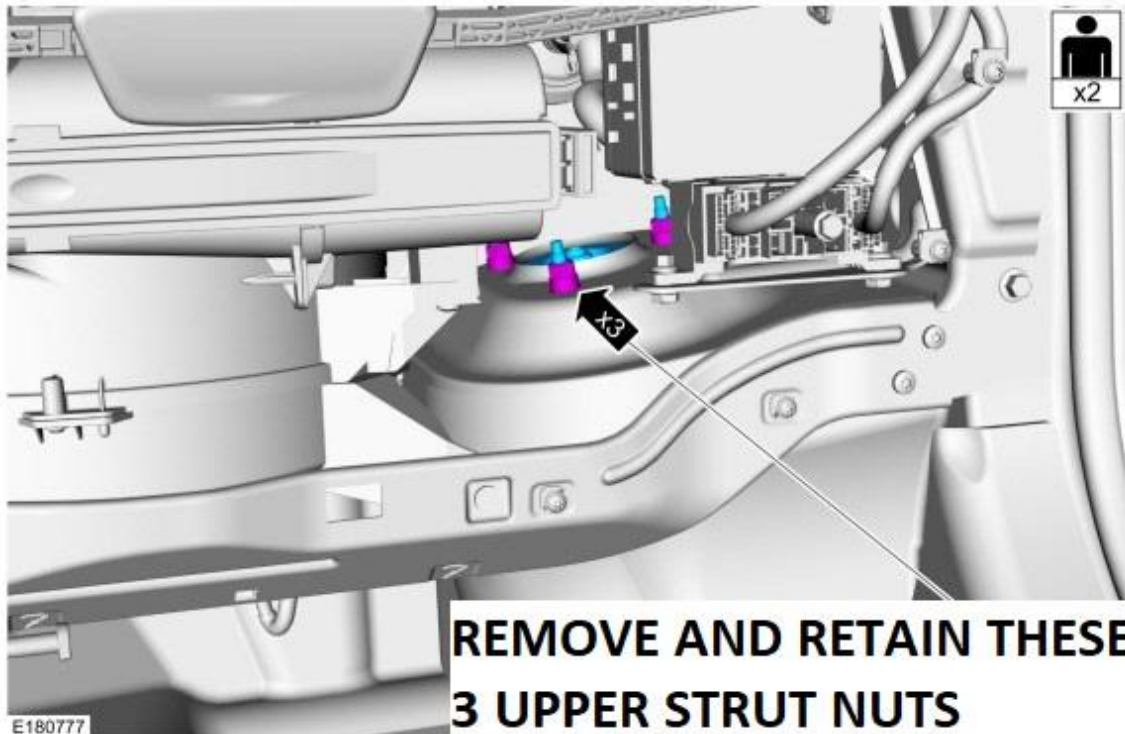

Coil and Strut Spacer Installation

- 20) Install the coil springs using a coil spring compressor. Make sure they are oriented correctly on the strut and sit properly on the lower coil spring isolator. The springs are different top and bottom but are the same left and right.
- To distinguish spring orientation, the upper strut bearing should snap snugly into place on the top of the spring.
 - Torque the upper strut nut to 41 ft-lbs. (55Nm) using an 18 mm socket / wrench
- 21) Use a 4-1/2" angle grinder or similar cutting tool to cut the studs of the upper strut hat to .625" tall (16mm). Check fit clearance by fitting the billet spacer to the strut hat. See image below for reference.

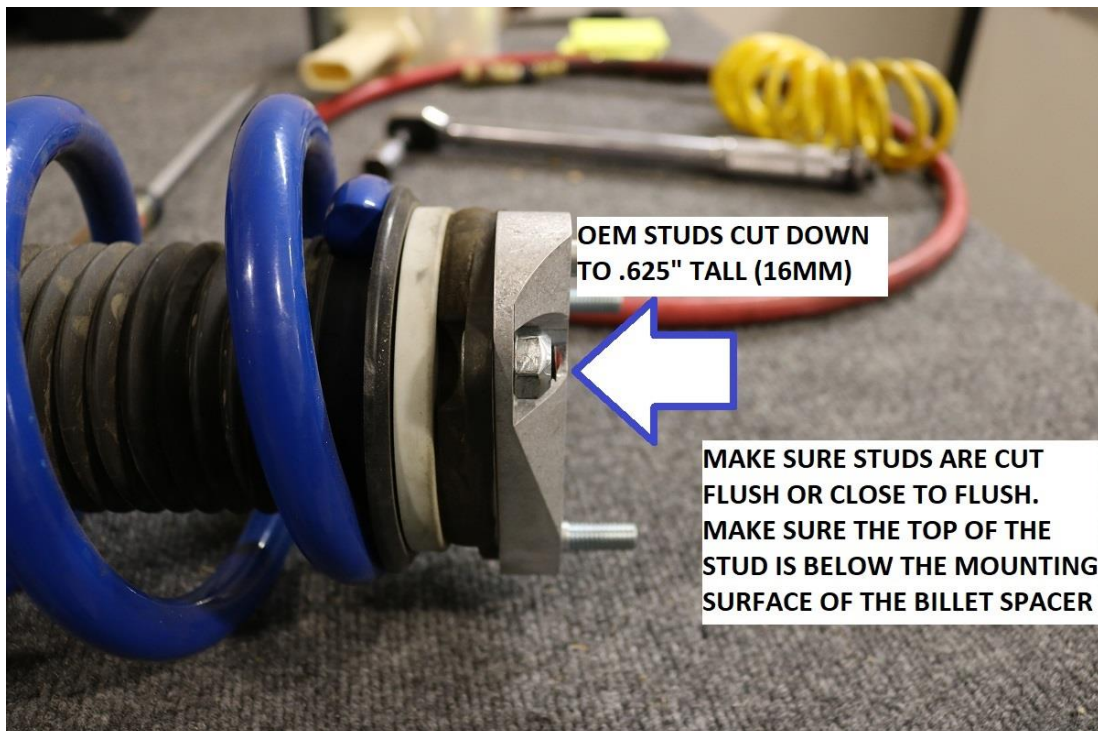

- 22) Install the strut spacers to the top of the strut. Take note that the spacers are cut with an L or R in them to distinguish what side of the vehicle they are to be installed on.
- Left = Driver side. Right = Passenger side. See the images below for reference of installation on the driver side strut.
 - Install the strut using the following hardware:
 - 2018-Present: M10-1.50 stover nuts, 17mm wrench, torque to 30 ft-lbs (41 Nm)
 - 2013-2017: M8-1.25 Stover nuts, 13mm wrench, torque to 22 ft-lbs (30 Nm)
 - Do not use a washer under the stover nuts.



- 23) Install the strut back into the vehicle. An assistant or floor jack will be needed to support the strut in place while the M10-1.50 stover nuts are started from the top. (Re-use the OEM upper strut nuts for bolting the strut back into the upper mount on the chassis.)
- Be sure to orient the L / R designator correctly. Install so the arrow is pointing towards the front.
 - See photo below for reference.

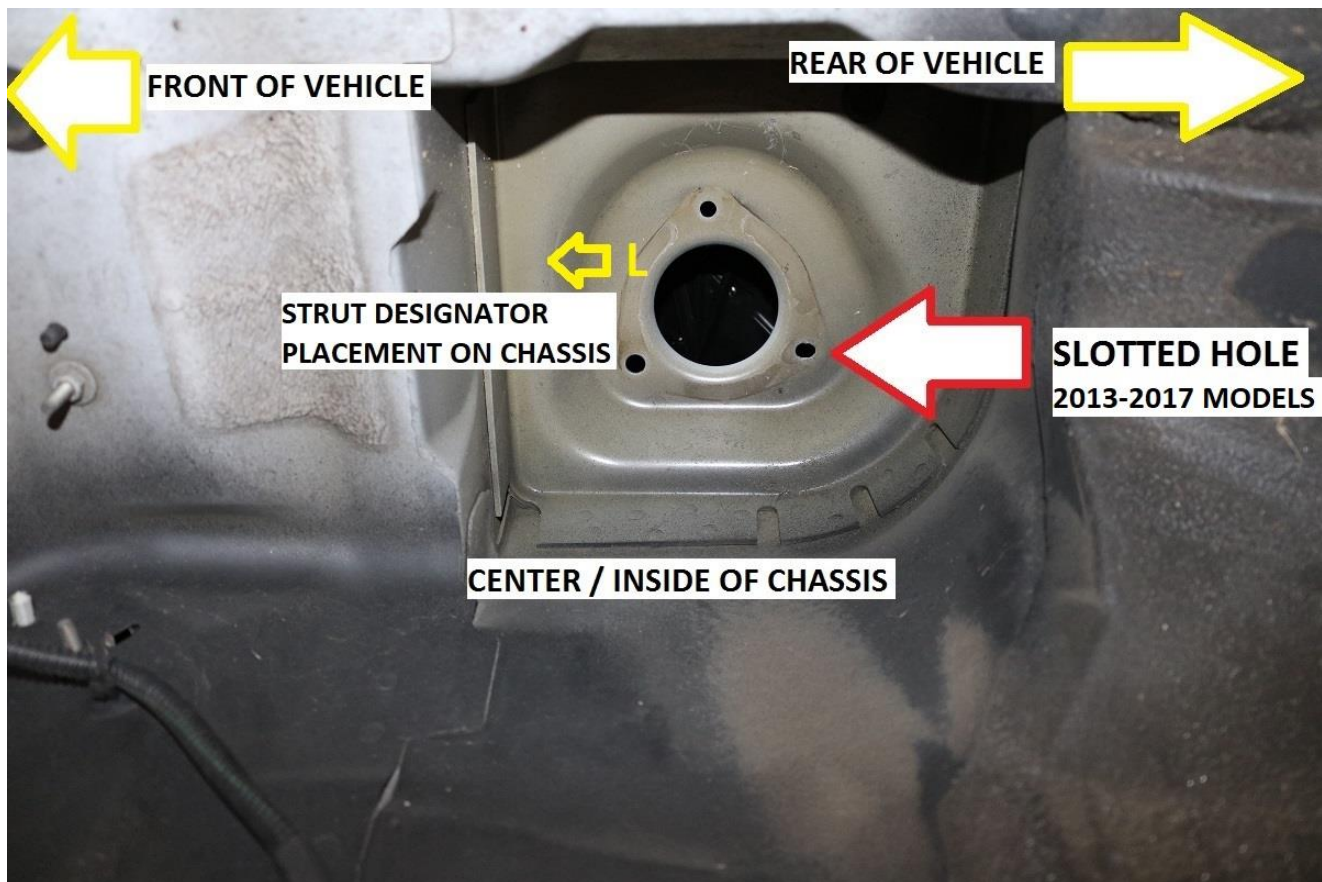

- 24) Start and snug all three nuts. Use a dab of Loctite on the threads.
- a. Use the following hardware depending on year of vehicle:
 - i. 2018-Present: M10-1.50 stover nuts, 17mm wrench, torque to 30 ft-lbs (41 Nm)
 - ii. 2013-2017: M8-1.25 Stover nuts, 13mm wrench, torque to 22 ft-lbs (30 Nm)
- 25) At this point, re-installation is the reverse order of removal.
- 26) We recommend coating the inside of the steering knuckle where the strut slides into place with some anti-seize. This will not only allow for easier installation, but will also allow for simpler removal of the strut down the line should replacement / service be required.
- 27) With the strut bolted in place up top, re-install the steering knuckle. Make sure the tab on the back of the strut aligns into the slot on the back of the steering knuckle. A floor jack or trans jack is helpful in holding the knuckle back in place.
- a. Make sure the strut is bottomed out in the steering knuckle.
 - b. Use a dab of blue Loctite on the threads and re-install the factory lower strut bolt. Use an 18mm wrench and torque to 76 ft-lbs (103 N.m). Rotate an additional 180 degrees after torque is achieved.
- 28) Install the CV into the hub but do not install the axle nut at this time.
- 29) Pry down the lower control arm until the lower ball joint can be re-seated into the lower control arm.
- a. Re-install the ball joint nut and torque to 184 ft-lbs (250 Nm) with a 30mm socket.
 - b. Note; while not necessary, it is beneficial to have a helper aide in prying the arm down and re-seating the lower ball joint.
- 30) Install the 102902 Sway Bar Link relocation tab as shown in the images below. The Tabs are bent different left to right.

- a. Note that the mounting holes in the tab are offset. Make sure the wider part of the tab is positioned towards the strut body with the bend flange going towards the chassis
- b. The outer edge of the tab should align with the outer edge of the original sway bar link tab on the strut body
- c. Use the included M12-1.50 x 25mm long hex head bolt with a washer under the bolt head. Secure to the strut using the M12-1.50 Nylock nut.

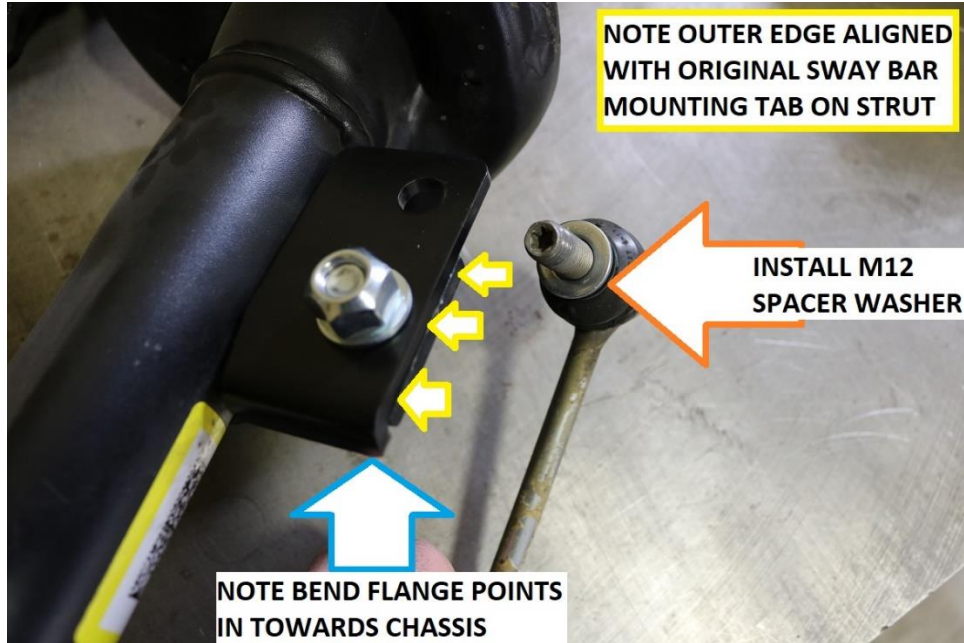

- 31) Tighten the M12 Hardware for the sway bar tab with a 19mm socket / wrench. Ensure the tab stays vertical or close to vertical when tightening. Torque bolt to 76 ft-lbs (103 N.m)
- a. Reconnect the sway bar end link to the strut. Install one of the M12 washers on the sway bar link stud prior to fitting it into the relocation bracket as shown above.
 - b. An 18mm socket / wrench and 6mm allen will be needed. Use the OEM nut and torque to 76 ft-lbs (103 N.m)



- 32) Reconnect the wheel speed sensor wiring and secure it back to the strut using the OEM clips. See image in step 12 and image below step 41 for reference.

33) Note; Bilstein B6 struts do not have the OEM speed sensor wiring clip built into the alignment tab. If installing Bilstein's, we recommend drilling a small 3/16" (5mm) hole in the bottom of the strut alignment tab to secure the wheel speed sensor wiring to the strut. See image below for reference.



34) Install the caliper back onto the steering knuckle. Use the OEM bolts removed in step 10 and a 21mm socket / wrench. Use a dab of blue Loctite on the threads and torque to 203 ft-lbs (275 N.m).

35) Install the tie rod end back onto the steering knuckle. Use a 21mm socket / wrench and torque to 59 ft-lbs (80 N.m)

36) Torque the axle nut with a 36mm socket to 250 ft-lbs (339 Nm).

Pinch Seam Trimming for 265/75/16 tire

37) If fitting 265/75/16 tires to the vehicle, the inner pinch seam will need to be trimmed to prevent tire contact at full compression. The flanged edge of the pinch seam needs to be cut off. Use a 4-1/2" angle grinder or similar cutting tool to cut off approximately 1/4" off the pinch seam.

- a. Use the outer layer of the pinch seam metal as a guide. Cut off the glued portion towards the flanged edge. Continue cut all the way up to where the flange ends. See images below for reference.

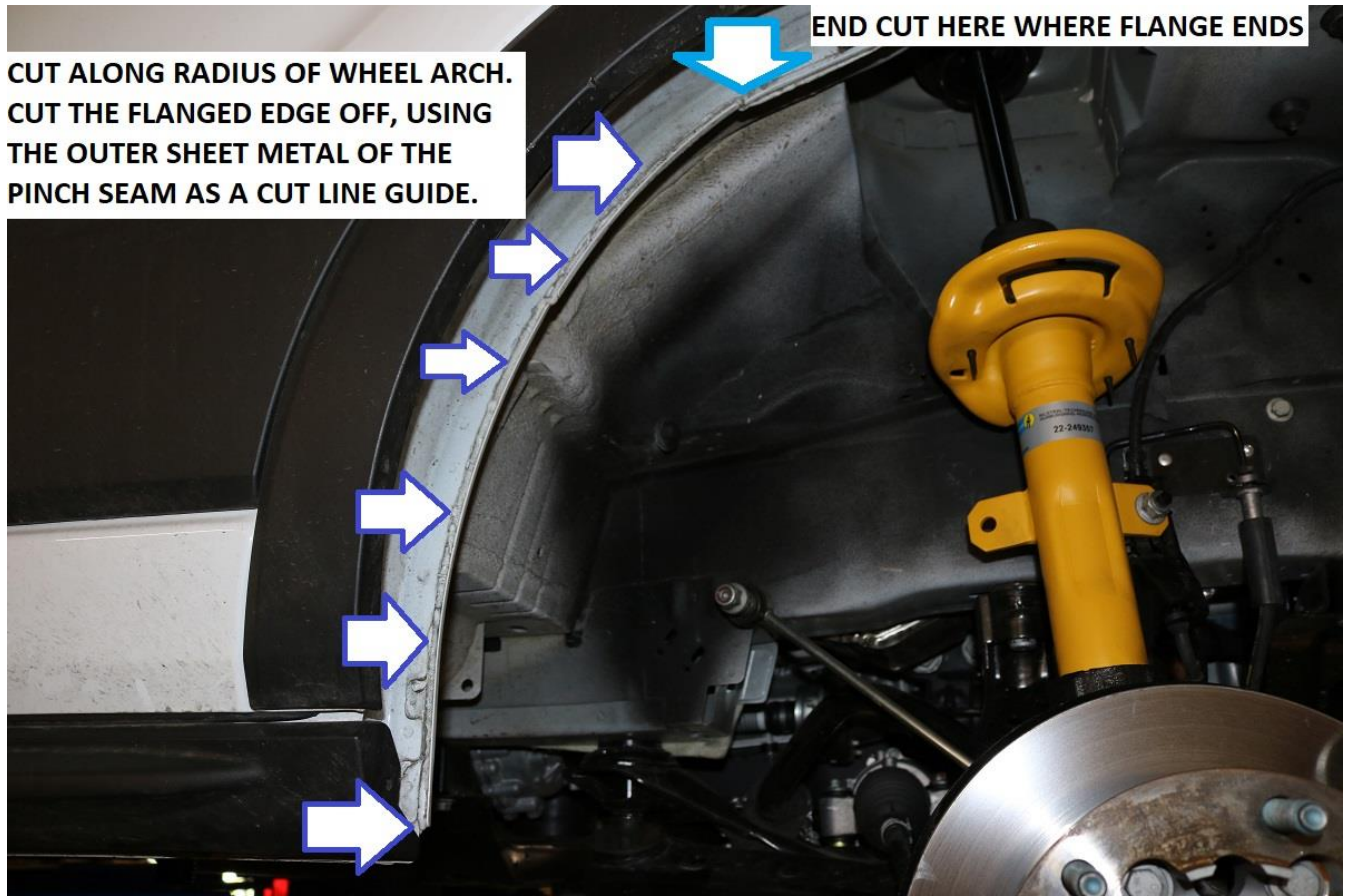

38) Towards the front of the wheel opening, locate the inner M6 bolt securing the front bumper fascia to the vehicle. There is a small flange that needs the corner cut off. Note, the outer fender trim piece is removed in this photo for clarity.

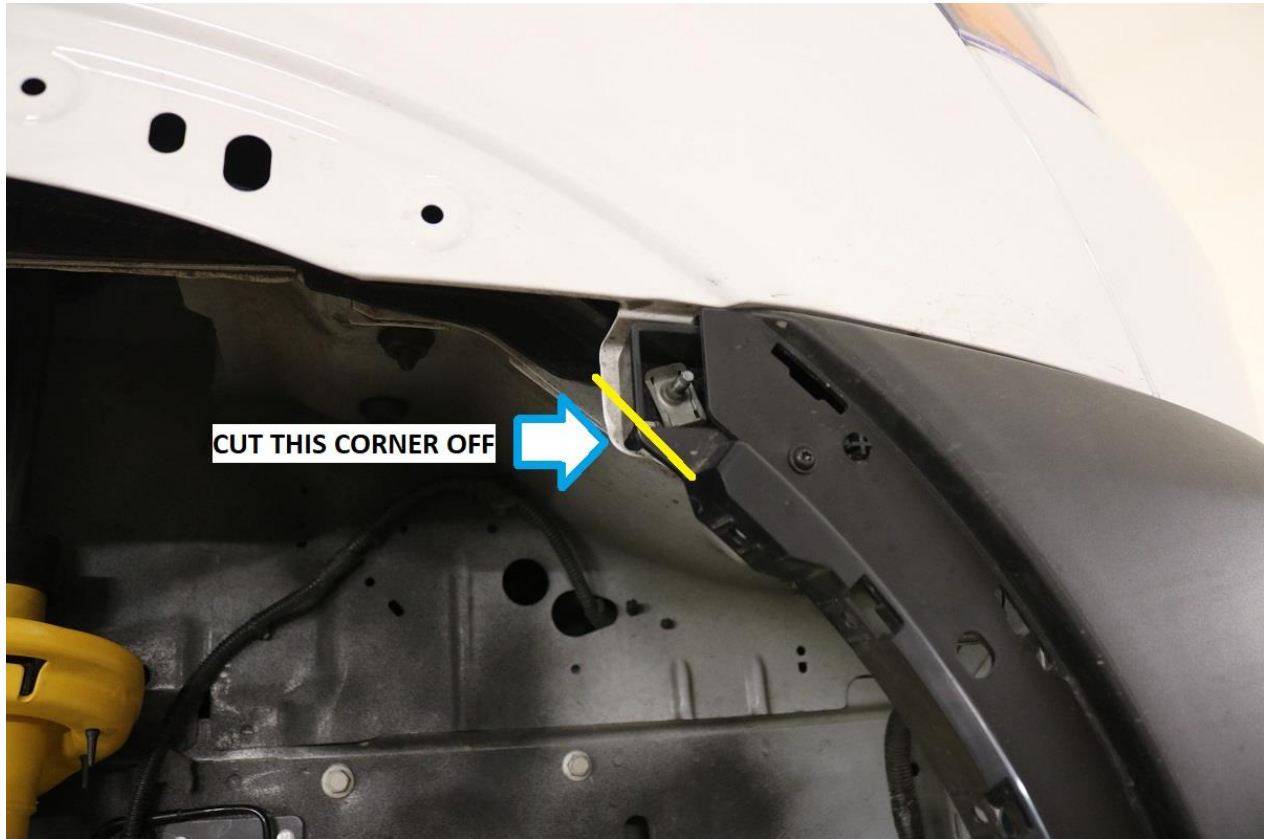

39) Lastly, the front bottom corner of the plastic front bumper fascia needs to be trimmed slightly for tire clearance.

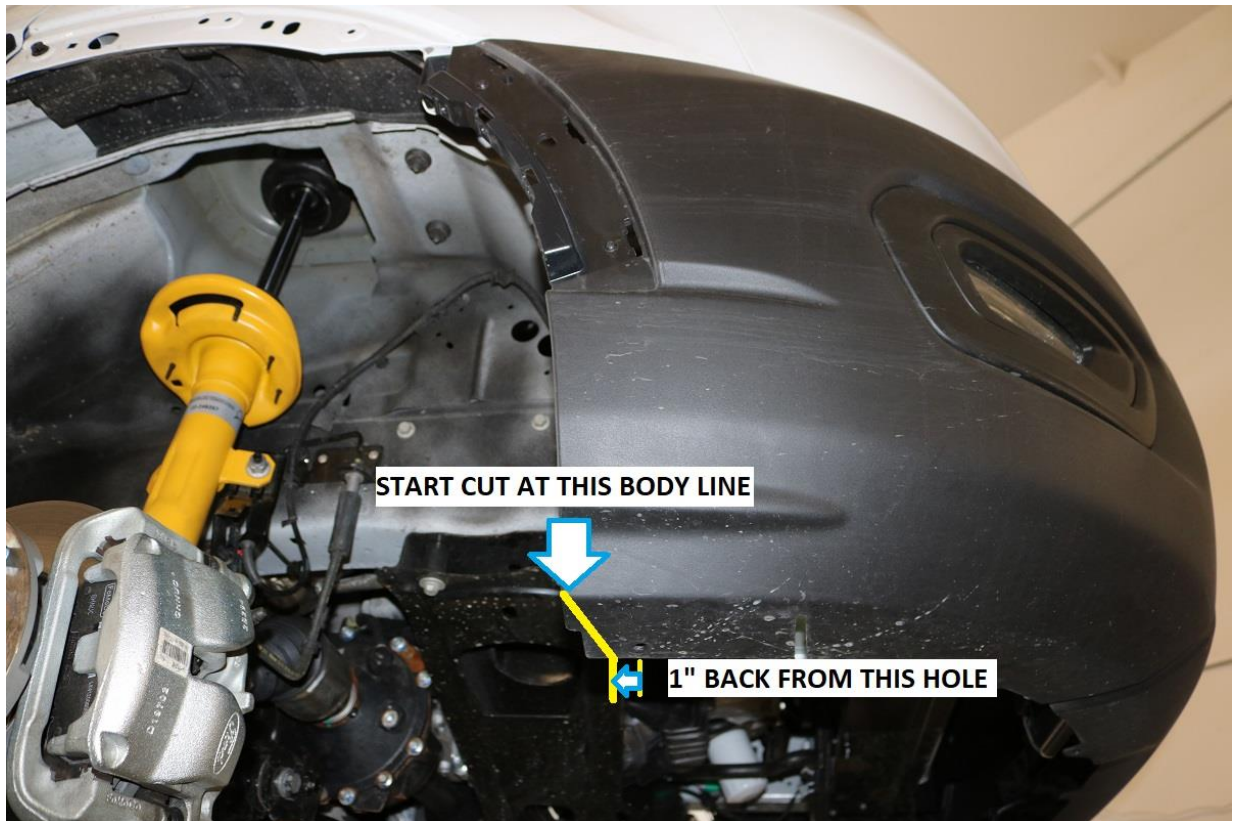

40) Re-install wheels / tires.

c. Lug nut torque for SRW and DRWs are the same; 148 ft-lbs (200 N.m).

41) Re-check all bolt torques after 100 miles of driving.

Installation is Complete

RELEASE OF LIABILITY

I, the customer, do hereby release and forever discharge Van Compass LLC, their agents, employees, successors and assigns, and their respective heirs, personal representatives, affiliates, successors and assigns, and any and all persons, firms or corporations liable or who might be claimed to be liable, whether or not herein named, from any and all claims, demands, damages, actions, causes of action or suits of any kind or nature whatsoever, whether known or unknown, fixed or contingent, which I now have or may hereafter have or claim to have, as a result of or in any way relating to the following: Parts sold & installed by Van Compass LLC or parts sold & installed by end-user; any parts sold online, any parts sold online or installed by a re-seller, any parts installed by an installation shop.

It is understood and agreed that this payment is made and received in full and complete settlement and satisfaction of the aforesaid actions, causes of action, claims and demands; that this Release contains the entire agreement between the parties; and that the terms of this Agreement are contractual and not merely a recital. Furthermore, this Release shall be binding upon the undersigned, and his respective heirs, executors, administrators, personal representatives, successors and assigns. This Release shall be subject to and governed by the laws of the State of Idaho.

PRODUCT SAFETY WARNING:

Van Compass LLC strongly recommends the installation of products be done by a certified mechanic. If this does not occur, be certain the person(s) installing the product read, understand and follow all instructions and warnings pertaining to the application before installation. Do not add, alter, or fabricate any factory or aftermarket parts to increase vehicle height over the intended height of the Van Compass LLC product purchased. Mixing component brands is not recommended.

Installation of suspension lift kits or any other lifting kits or devices will raise the center of gravity. For this reason, Van Compass LLC urges that extreme caution be used when encountering driving conditions which may cause vehicle imbalance. Furthermore, the driver's field of vision and judgment will not be as good due to the height of the vehicle. Due to the installation of larger tires, the speedometer will read slower than the actual speed being traveled and more distance will be required to stop the vehicle. It is the owner's responsibility to caution and warn any potential driver of the vehicle about these driving and handling conditions. Van Compass LLC will not be held liable or responsible for damages or personal injuries resulting from the use of lifting devices and or related products. The tires and rims should be changed to sufficiently increase the vehicle's total overall width and stability to help accommodate lifting devices.

Van Compass LLC aftermarket suspension products and accessories modify a vehicle for uses which exceed conditions anticipated by the vehicle manufacturer. The uses include the high performance demands required during off-road. These conditions vary in the degree of extremity and cannot be controlled by the vehicle or product manufacturer. If the components within the suspension system or accessories become worn due to frequent and/or extreme use, the safety and reliability of the vehicle is at risk. The maintenance of aftermarket equipment to ensure the vehicle occupants safety is entirely your responsibility. Do not purchase Van Compass LLC products unless you are willing to accept this responsibility. Do not install any Van Compass LLC

suspension products or accessories unless you feel competent at installing the product without causing present or future injury to yourself or other vehicle occupants; seek an authorized installation center.

Most states have some type of law limiting vehicle height. The amount of lift allowed, and how the lift can be achieved, varies greatly. Several states offer exemptions for farm and commercial registered vehicles. It is the vehicle owner's responsibility to check state and local laws to ensure that their vehicle will be in compliance. Van Compass LLC reserves the right to make changes in design, materials and specifications as deemed necessary without prior notice and without assuming obligation to modify any product previously manufactured. Obligation or liabilities will not be assumed with respect to similar products previously advertised.

This Release of Liability and Product Safety Warning has been read and fully understood by the undersigned and has been explained to me.