



CLUB GLOVE USA

QUALITY

QUALITY THAT GETS NOTICED

“**CLUB GLOVE**® is my number one travel companion! It is durable, functional and stylish! What more can one ask?” – *Henrik Stenson, PGA Tour*



Henrik Stenson - photo courtesy of John Bazemore, AP

“I have yet to see any other bag on the market that is as durable and easy to carry anywhere”

– *K Vakamudi, GolfWRX*

“I think your new TRS line is incredible....durable, easy to use, it all fits together so well and is easy to maneuver through the airports, and it’s attractive!” – *Peter Jacobsen, Champions Tour*

“Everyone should have the best towel on the market attached to their bag. That distinction goes to the **CLUB GLOVE**® Caddy Towel.”

– *Jason Crook, GolfChannel.com*

AWARD WINNING INNOVATION



2013 TECHY AWARD
TECHIEST TRAVEL BAG



COMPANY OF
THE YEAR



Nominee 2010

BEST

OF THE 2013
PGA SHOW



THINK YOUNG / PLAY HARD

HOT

PRODUCT
OF THE 2013
PGA SHOW



Celebrating 25 Years of Quality Made In America Products to Enhance the Game

**MADE IN
USA**

QUALITY

At **CLUB GLOVE**® uncompromising quality, function, durability and longevity are at the forefront of each innovation. Our products are built to last a lifetime. Built with the hard core world traveler in mind, our goal is to design and make products that golfers and travelers depend on for life.

CORDURA® Fabric

Cordura® Brand Fabric is an exceptionally reliable and versatile nylon material. It is 3x stronger than standard polyester and 2x stronger than standard nylon with excellent abrasion and tear-resistant properties.

ITW Nexus® Buckles

The patented design of ITW Nexus® Buckles is functionally superior, allowing for single-handed release and preventing unintentional opening. Made of the highest quality materials.

Nylon Webbing

High-tensile strength nylon webbing creates a reinforcing exoskeleton support for a bag that won't quit.

YKK® Zippers

The unrivaled quality of YKK® Zippers ensure smooth usage of **CLUB GLOVE**® luggage for the lifetime of your product. Bad zippers break bags, making them unusable.

Diamond Rivet Reinforcing

Our signature diamond rivet reinforcement pattern ensures your bag will last longer than you do on extended trips.

High-Impact Wheel Base

Featuring a built-in retractable handle, the patented high-impact wheel base cradles and protects your rolling luggage. This innovation provides unrivaled protection and durability.

Soft Cushion Skate Wheels

High quality in-line soft cushion skate wheels are paired with quality bearings for a glide as smooth as butter and as quiet as a mouse.





Train Reaction®

integrated luggage connecting system

The World's Only Self-Balancing Luggage Connection System

CLUB GLOVE's exclusive, integrated patent-pending Train Reaction® luggage connection system allows you to easily transport over 100 pounds of luggage with just one hand. Simply choose the luggage pieces that best suit your travel needs and easily connect them together into a perfect "train" that self-balances without toppling. You'll love having a free hand to manage other things in your life, such as phone calls or a cappuccino. Visit ClubGlove.com/Patents for all patent information.

ROLL LIKE A PRO

Build Your Own Self-Balancing Luggage Train With One or More Pieces From Each Category

Leading

- TRS Ballistic Carry-On
- TRS Ballistic Check-In
- Carry-On II
- Mini-Rolling Duffie II
- Rolling Duffie II

Trailing

- TRS Ballistic Check-In XL
- TRS Ballistic Check-In
- Rolling Duffie II XL
- Rolling Duffie II
- Last Bag® XL/Last Bag®
- Burst Proof w/Wheels II

Accessory

- Shoulder Bag II
- Shwine Bag/Shoe Bag II
- Gear Bag
- TRS Ballistic TravelRx
- TRS Ballistic Executive Backpack
- Backpack III
- **NEW** Country Club Bag



DEFY GRAVITY

Pack, Connect, Glide.

INNOVATION



1. Position smaller luggage in lead position with trailing piece behind.



2. Release the Train Reaction strap from the trailing piece.



3. Place Train Reaction Strap over the handle of the leading piece.

4. Extend the leading piece's handle.



5. Slide accessory piece onto the leading handle



6. Tilt your Train Reaction ensemble onto its wheels. Now you're rolling like a pro!

7. At check-in, separate luggage and check the largest, heaviest piece

8. Remaining 2 pieces can be wheeled onto plane or train. For lower center of gravity attach J-Hook to carry smaller piece



OUTSMART THE AIRPORT CART

Connect Any Of Our Legendary Travel Bags To The Carry-On II Using The J-Hook

INNOVATION

Burst Proof II
pg. 11

The Last Bag®
pg. 10



Carry-On II
pg. 14



Self-Balancing!



Fully extend Carry-On handle.
Remove J-Hook from the
Luggage pocket



Position J-Hook over handle
and wrap strap down...



...and around the handle



Slip J-Hook through
handle loop and pull tight



Place golf travel bag top handle
onto J-Hook



Golf travel bag is now
secure and ready to roll



TRS BALLISTIC

The new standard in American made luggage

TRS BALLISTIC

The Word is Out About The World's Best Travel Luggage



"Club Glove is basically a company that guarantees your clubs and clothes will make it to your destination without a scratch. As a golfer, I don't see any product out there that could compete here." - *Shane Bacon, CBS Sports*

"I have been traveling nonstop for 38 years and go through luggage like I go through paper coffee cups. I purchased your TRS Ballistic Premium full set of luggage and I must say, this is amazing luggage. I have never really liked packing a bag and dragging it around but this makes that task a pleasure. You have a great product here. I may never have to buy luggage again." - *Edward Allen, Fredericksburg, Virginia*

"The Desert Mountain member expects only the best when it comes to travel luggage and nothing fits that description better than Club Glove's new TRS Ballistic. Fashion, Function and Durability all in one!" - *Travis Albright, PGA Assistant Professional, Desert Mountain Club, Arizona*

"The new TRS Ballistic line is the most reliable, durable, and functional luggage we have ever carried in the shop. And as an added bonus, the margins are incredible." - *Andy Roberson, PGA Assistant Professional, Flint Hills National Golf Club, Kansas*

The World's Only Self-Balancing Luggage Connection System

"Transporting the TRS Ballistic luggage was smooth. **CLUB GLOVE**® wasn't kidding when they mentioned it was a perfectly balanced system. Amazing how effortless it seemed. All in all the TRS Ballistic luggage was excellent, extremely organized and very simple to transport." - *Erica Jessop, Examiner.com*

"My members recognize and insist on quality that's why we stock only **CLUB GLOVE**®. Oh, and the margins? Well, bravo **CLUB GLOVE**®!" - *John Kennedy, PGA Head Professional, Westchester Country Club, New York*

"Hard to imagine **CLUB GLOVE**® could create an even more durable product than their original line, but that's what they did with the Ballistic series. The club benefits from the amazing margins and the customer appreciates the quality. Truly a win-win!" - *Amy Pendergast, PGA Head Professional and Director of Retail, Bandon Dunes*

Designed for the Affluent
Globetrotter or Discerning Golfer

Self-Bal

TR5 BALLISTIC

Train Reaction
instructions on pg 6



PRO grade



Custom embroidery shown

BEST
OF THE 2013
PGA
SHOW



D. TravelRx

Rugged yet elegant, CLUB GLOVE® has designed the perfect overnight bag. This versatile piece of luggage allows you to divide the ample space into two different compartments for desired packing. This over-engineered doctor style bag includes an ergonomic shoulder strap and a lower compartment venting that's perfect for shoes. Winner of the 2013 PGA Best In Show Award and made with the world's finest fabrics to last a lifetime.

13" H x 20" W x 10" D, 43 linear inches (3.8 lbs) TRBRX \$399

- Cavernous, unobstructed top opening with 4 zippered mesh pockets and floor compartment for unlimited packing options

E. Dual Access Shoulder Bag

This premium laptop/accessory bag features access on both sides. 9 total pockets and a split interior allows one to organize their personal belongings with electronics on one side and liquids and/or toiletries on the other. This is the perfect bag to have at your feet while relaxing in your airline seat. Includes a hidden cell phone holster as well as front and rear quick-access pockets. Made with the world's finest fabrics to last a lifetime.

13" H x 16" W x 4" D, 33 linear inches (3.0 lbs) TRSD \$350



ancing!

GO BALLISTIC

TRS BALLISTIC

Rolling Luggage

This premium rolling luggage is available individually or as a 3-piece ensemble. Each piece is designed with a full zippered front opening for easy loading. The integrated Train Reaction system allows one to connect 1, 2 or all 3 pieces in a matter of seconds, relieving the stress of traveling with multiple pieces of luggage. Each piece includes a complete set of clothing organizers (pg. 13) to organize your life on the road. Made with the world's finest fabrics to last a lifetime. Available in 2 webbing colors.

A. Check-In XL includes 1 large, 2 medium, 2 small Packing Modules. **31" H x 15" W x 12" D, 58 linear inches (13.8 lbs) TRBX \$799**

B. Check-In includes 1 large, 1 medium, 2 small Packing Modules. **28" H x 14" W x 11" D, 53 linear inches (10.9 lbs) TRBL \$750**

C. Carry-On includes 1 large, 1 medium, 1 small Packing Modules. **22.5" H x 13" W x 9" D, 44 linear inches (9 lbs) TRBS \$699**

A.-C. 3-Piece Ensemble \$2,248

• Minimize needed storage space by nesting luggage pieces. All 3 pieces fit into one!

• A complete set of Clothing Organizers with each piece eases your travel experience

F. Executive Backpack

The perfect backpack for the traveling executive. At first look, you will notice the unique shape of this backpack allowing for additional laptop and cargo space. Toss in a packing module and a CG Travel Kit to create a quick overnight bag. Combine the Executive Backpack with the TRS Ballistic Carry-on (as seen left) and tote additional gear while still travelling in the world of carry-on only. Made with the world's finest fabrics to last a lifetime. Available in 2 webbing colors. **19" H x 16" W x 9" D, 44 linear inches (2.0 lbs) TRBP \$350**



RIGHT: The Executive Backpack (F.) is secured to the front buckle of our Ballistic Carry-On (C.). Add the Dual Access Shoulder Bag (E.) for an efficient ensemble with a low center of gravity for perfect balance.

All TRS Ballistic Luggage Pieces Are Available In:

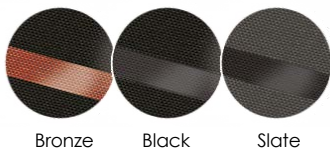

800.736.4568 | 714.843.9288

The Last Bag[®] & Last Bag[®] XL Legendary.



PRO grade



Custom embroidery shown

Train Reaction[®]
integrated luggage connecting system

A. Last Bag[®] /B. Last Bag[®] XL

#1 travel bag on Tour. These travel bags accommodate nearly any golf bag and up to a 47" driver, plus additional room for gear/luggage pockets and 2 exterior shoe/storage pockets. XL is for extremely large tour bags only and not recommended for walking bags or smaller cart bags. There's a reason nearly every touring professional and college player uses a Club Glove[®] - they're the best travel bags in golf.

Always take extra care in packing additional soft items around your club heads to prevent movement (Stiff Arm[®] recommended). Made in USA. Limited lifetime warranty. 5-year NQA warranty available.

- A. Last Bag 51" H x 19" W x 16" D, 86 linear inches (10.6 lbs) TBLB \$299
- B. Last Bag XL 54" H x 22" W x 19" D, 95 linear inches (11.2 lbs) TBLX \$329

C. Stiff Arm[®]

This fully adjustable, 3-piece telescoping club protector fits all CG travel bags & up to a 47" driver. Adjust the Stiff-Arm slightly longer than the longest club in your bag to protect all your clubs from vertical impact. More than 30 times stronger than the competition, based on independent lab testing from Exova OCM. (1.2 lbs) SASR \$29.95



Vertical Impact Protection For Your Clubs!

The Stiff Arm
CRUSHED
the competition!

See The Video on ClubGlove.com



The Most Trusted Travel Bags - In All of Golf -

Burst Proof w/Wheels II

Travel Bags

Self-Balancing!



Train Reaction
instructions on pg 6

Roll like a PRO! The Carry-On II is the perfect companion to the Last Bag/XL and Burst Proof II. This J-Hook (pg. 6) connected ensemble self-balances without toppling. In a world of imperfect walkways and surfaces, it is easily pulled with just 1 hand.



D. Burst Proof with Wheels II

This prolific seller is a staple in every pro shop. This premium fitted collapsible bag is perfectly sized for most stand bags and remains the #1 travel bag in collegiate golf. Built with the same high quality features as the Last Bag®. There's a reason nearly every touring professional and college player uses a CLUB GLOVE®. Shoe pockets strategically located inside the bag. Made in USA. Limited lifetime warranty. 5-year NQA warranty available. 51" H x 15" W x 14" D, 80 linear inches (8.0 lbs) TBBW2 \$229

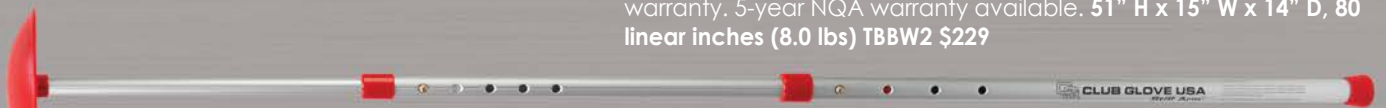

Travel Bags Available in 16 Color Combinations:

black/copper black black/pink navy royal blue steel green moss khaki camo clay charcoal burgundy mocha red sungold



800.736.4568 | 714.843.9288

Rolling Duffles - Engineered for Any Travel

Rolling Duffles

- Extra long retractable handles



- Single-Piece burst proof construction

- Ballistic nylon bottom



Self-Balancing!

Organize Your Life

Pack Like a Pro!

Rolling Duffles

Team: Reaction
instructions on pg 6

Roll like a PRO! The Mini Rolling Duffel II is a great companion to the Last Bag/XL and Burst Proof II. This J-Hook (pg. 6) connected ensemble self-balances without toppling. (J-Hook sold separately)



- Rugged, patented high-impact base

A. Rolling Duffel II XL

This large travel bag is the largest allowable airline check-in bag. It easily accommodates enough clothing for 2 or more weeks travel time. Includes set of large and medium clothing organizers to maximize packing efficiency. Made in USA. Limited lifetime warranty. 5-year NQA warranty available. **33" H x 16" W x 13" D, 62 linear inches (10.8 lbs) GLDX2 \$319**

B. Rolling Duffel II

This mid-size airline check-in travel bag accommodates enough clothing for approximately a 1 week travel time. Includes set of large and medium clothing organizers to maximize packing efficiency. Made in USA. Limited lifetime warranty. 5-year NQA warranty available. **28.5" H x 13.5" W x 11.5" D, 53.5 linear inches (9.0 lbs) GLDS2 \$299**

C. Mini Rolling Duffel II

This compact airline carry-on travel bag is perfect for the weekend traveler. Built to the same rugged standards as its larger counterparts, it is designed to be the largest size allowed on-board most commercial airlines. Made in USA. Limited lifetime warranty. 5-year NQA warranty available. **23" H x 12.5" W x 9.5" D, 45 linear inches (7.4 lbs) GLDM2 \$199**



Clothing Organizers

Change the way you pack forever with these premium, lightweight and breathable mesh cloth organizers. Keep your clothes organized and protected. Order in sets of two (same or different size). Available in black.

- D. MOC11 (Large: 17" H x 12" W x 5" D) \$16.95 ea
- E. MOCM1 (Medium: 17" H x 12" W x 3" D) \$14.95 ea
- F. MOCS1 (Small: 12" H x 8" W x 4" D) \$12.95 ea

Rolling Duffles Available in 16 Color Combinations:



Carry-Ons - Rugged & Portable

Carry-Ons

Carry-On II

This premium airline roll aboard travel bag easily fits in most overhead storage bins. The included interior clothing divider and set of large and small clothing organizers make packing a dream. J-Hook (pg. 6) included for carrying an additional smaller luggage piece or transporting any of our golf travel bags. Made in USA. Limited lifetime warranty. 5-year NQA warranty available. **22.5" H x 13" W x 9" D, 43.5 linear inches (9.0 lbs) GLCO2 \$379**



Wheels facing out

Actual Airline Photograph

Most Airlines have a maximum allowance of 45 linear inches for carry-on items that are to be stowed overhead or under the seat in front

When stowing the Carry-On in overhead bins, position the wheels facing out toward the aisle as shown

When unloading the Carry-On use grab handle on bottom of rolling chassis to pull luggage out of bin

Self-Balancing!



Train Reaction instructions on pg 6

Roll like a PRO! The Mini Rolling Duffle II is a great companion to the Last Bag/XL and Burst Proof II. This J-Hook (pg. 6) connected ensemble self-balances without toppling. (J-Hook sold separately)

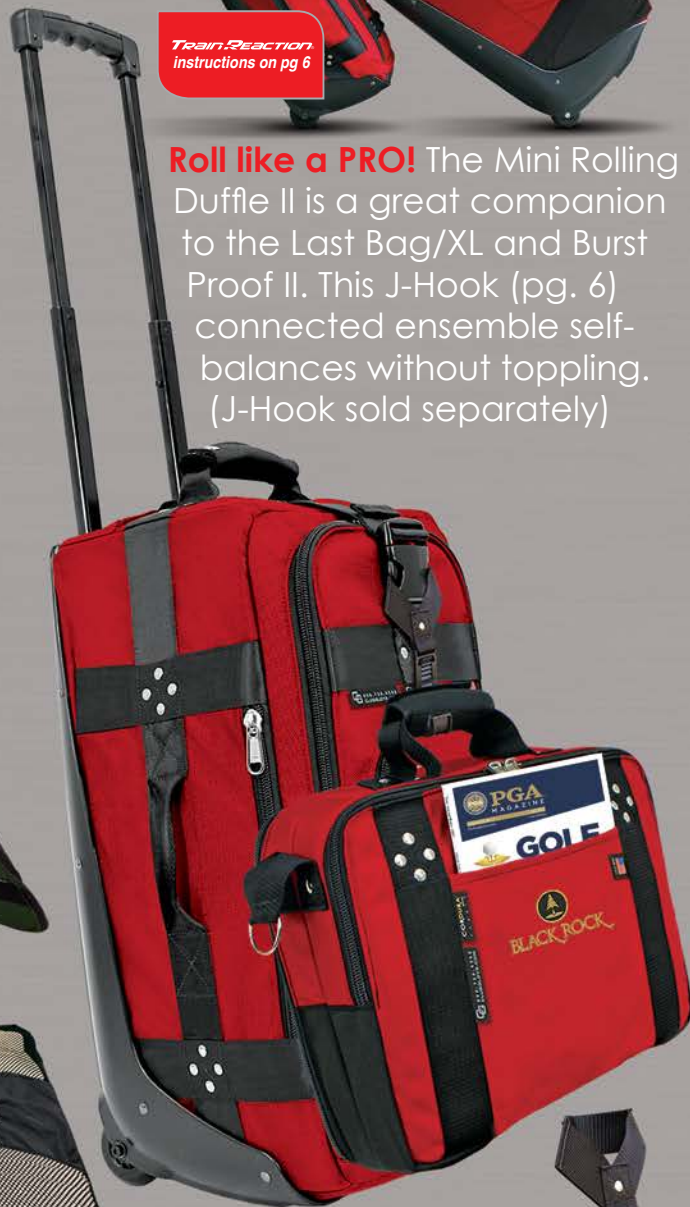

• J-Hook (pg. 6)



PRO grade



Custom embroidery shown

CLUBGLOVE.COM USA

Built to Last

Dual Access Shoulder Bag II

This premium laptop/accessory bag features access on both sides. 9 total pockets and a dual access split interior allows one to organize their personal belongings with electronics on one side and liquids and/or toiletries on the other. This is the perfect bag to have at your feet while relaxing in your airline seat. Includes a hidden cell phone holster as well as front and rear pockets to quickly stash a magazine or newspaper while on the run. Made in USA. Limited lifetime warranty. 5-year NQA warranty available. 12" H x 16" W x 4" D, 32 linear inches (3.0 lbs) GLSD2 \$199



Carry-Ons

Ergonomic padded shoulder strap with no-slip fabric



PRO grade



Custom embroidery shown

NEW Backpack III

This premium backpack can easily accommodate a laptop. It is both durable and versatile containing 7 total pockets to keep all of your gear organized. Travel in comfort with the adjustable, padded shoulder straps. Elastic band mesh pocket on left is perfect for water bottles, while the zippered mesh pocket on the right is a great home for keys, wallets or cell phones. Made in USA. Limited lifetime warranty. 5-year NQA warranty available. 19" H x 16" W x 9" D, 44 linear inches (2.0 lbs) GLBP3 \$189



Carry-Ons Available in 16 Color Combinations:

black/copper black black/pink navy royal blue steel green moss khaki camo clay charcoal burgundy mocha red sungold



Unique Carry-Alls - Rugged & Portable

A. Shoe Bag II or B. Shwine Bag

Looking for the perfect tournament gift? This premium, padded, plush nylon interior protects your shoes or wine and stands upright when loaded.

Dual vent holes keep your gear breathing. Deluxe shoe horn included. Shoe/Wine (Shwine) bag includes a deluxe wine opener and two removable Velcro sleeves for wine. Made in USA. Limited lifetime warranty. 5-year NQA warranty available. 13" H x 10" W x 6" D, 29 linear inches.

A. Shoe Bag II GLSH2 \$69

B. Shwine Bag ZZWHS \$89



B



A

Bottle Opener & Shoe Horn Included, Wine & Shoes Not Included.



PRO grade



Custom embroidery shown



C

C. Gear Bag

This is the ideal overnight, airline carry-on or gym bag. It's one of those modest, rugged bags that will simply last forever. Dual side pockets, one zippered. Made in USA. Limited lifetime warranty. 5-year NQA warranty available. 10" H x 16" W x 10" D, 36 linear inches (1.3 lbs) GLGB \$109

D. Travel Kit

This streamlined design with a full access u-shaped zippered top allows you to find the items you need quickly and conveniently. Designed to slip into the Shoulder Bag or Backpack. Small zippered toothbrush compartment in front. 3.25" H x 11" W x 8.25" D, GLTK \$39.95



D

Carry-Alls Available in 16 Color Combinations:

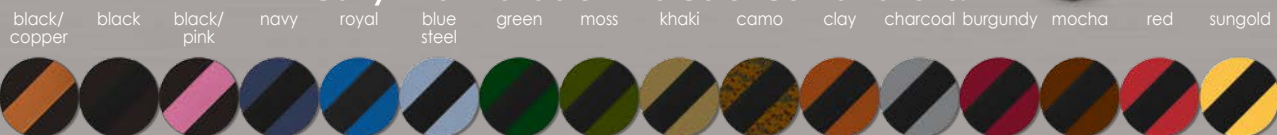

Organize Your Life

with a new way to roll your garments



E. Suit Organizer II

Need a rolling garment bag? The Suit Organizer II will turn nearly any of CLUB GLOVE®'s rolling luggage pieces into your favorite rolling garment bag. This piece will even fit inside the TRS Ballistic TravelRx (pg. 8) lower compartment. This tri-folding, durable, lightweight piece drastically reduces wrinkles on your suits & fine garments. Simply secure your hung garments in the mesh compartment, fold the organizer and place inside any rolling Train Reaction luggage piece. After travelling with this piece you will wonder why the rolling garment bag was ever invented. Works as a perfect complement to the modular packing system created by our mesh clothing organizers. Made in USA. Limited lifetime warranty. 5-year NQA warranty available. **42" H x 24" W x 4" D (flat), 70 linear inches (1.2 lbs) GLSO2 \$89.95**

Train Reaction®
integrated luggage connecting system



PRO grade



Custom embroidery shown



F. NEW Country Club Bag

The go-to bag for short trips to the gym or country club. Built with adjustable handles to let you to carry it by your side or throw over your shoulder. The exterior features dual side pockets for quick-access storage and integrated TRS (Train Reaction System) technology. This getaway bag has a limited lifetime warranty. Made in the USA. 5-year NQA warranty available. **12"H x 17"W x 10"D (1.3 lbs) GLCC \$159**

Billboard Bags - Professional Quality



Cart Bags

Billboard Bag®

With a classic, timeless design, this bag has been used by hundreds of Tour players and several U.S. Ryder Cup teams. Personalize with our beautiful custom inlay work just like the VIPs, dignitaries, world leaders and the finest golf teams in the world. 9.5" top opening with 6 dividers and 12 total gear pockets (1 soft-lined). Beautiful black chrome accents, lightweight Tour-style rain hood and umbrella holder included. Limited 2-year warranty. Available in 6 colors. **(12.0 lbs)**

CBBB Call for pricing

Black/Gray

White/Royal

White/Red



Black

White

Top View: Opening

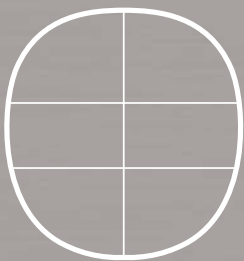

9.5"

9"

- Unlimited custom embroidery and inlay options
- Shown with custom embroidery & hand cut inlay. Personalization is available on 3 removable panels (2 sides + 1 front), 2 small front pockets, 2 small rear pockets, and strap



Red

Cart Bags - Classically Designed

Cart Bags

- Stainless steel cart belt rings

Royal

FCO III

This luxury For Carts Only bag is for the serious player who demands the best. Timeless traditional-styling with easy access to nearly every strategically placed pocket. 8.5" top opening with 6 dividers and 9 total gear pockets (2 soft-lined). Beautiful black chrome accents, stainless steel cart belt rings, lightweight Tour-style rain hood and umbrella holder. Outer shell constructed of premium simulated elephant skin vinyl and water resistant ballistic nylon for durability that is up to 3x stronger and lasts up to 5x longer than standard polyester. Limited 2-year warranty. 5-year NQA warranty available. Available in 5 colors. **(9.6 lbs) CBFL3 \$299**

Black

Navy

White

Red



Top View: Opening

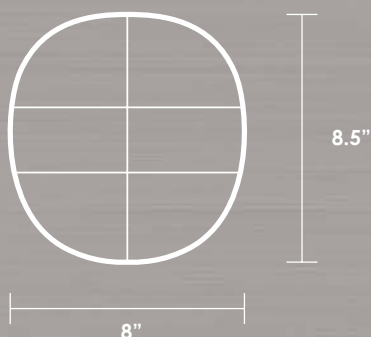

- Personalize with a name, initials or logo with custom embroidery
- Shown with custom embroidery available on 3 removable panels (2 sides + 1 front)



The Original Microfiber, Waffle Textured Golf Towel

Soft enough
to clean your
sunglasses with a
thick texture to
clean your clubs



The Cart Towel **NEW COLORS**

Made with the classic microfiber, waffle-textured pattern that has grown to be the standard in golf towels, the Cart Towel is designed with a built in button-hook loop for easy attachment to carts or bags. This smaller towel is perfect for a quick 9 holes and the perfect tournament gift when paired with custom embroidery or ink sublimation. Don't be fooled by cheap imitations. Our premium microfiber golf towels are demanded by Tour players and their caddies. Super absorbent waffle-texture holds 300% of its weight in water and is non-abrasive and virtually lint free, safe enough for cleaning precision eyewear. Exceeds professional Tour standards and outperforms any other towel in golf. Available in 5 colors, including the new Slate and Royal. **16" x 24" TGMF \$12.95**



The Cart Towel (left) is made with the same great materials as The Caddy Towel (above)

“There are so many things I could say about this towel. I’ll make it simple: it’s the perfect golf towel.”

– Chris DiMarco, PGA Tour

Simply The BEST Towel in Golf

Caddy Towel



White w/ Pink



PRO grade



Custom embroidery shown

• 8" large elongated center slit for fitting over club head.

White

A \$10 VALUE!

• Free matching 8" x 12" pocket towel included

FREE
Pocket Towel

Available With
Sublimation
OR
Embroidery



The Caddy Towel

Don't be fooled by cheap imitations. Our premium microfiber golf towels are demanded by Tour players and their caddies. Super absorbent waffle-texture holds 300% of its weight in water and is non-abrasive and virtually lint free, safe enough for cleaning precision eyewear. Exceeds professional Tour standards and outperforms any other towel in golf. Includes matching 8" x 12" pocket towel. Available in 15 colors. 17" x 40" TGMF \$19.95

More wins on tour with our waffle textured design towel than any other towel in golf.

We've got you covered

Gloveskin® Premium Hybrid Covers

If you prefer a hybrid cover that fits like a glove, you will love these premium, light-weight neoprene hybrid covers. Custom fit to the most widely used hybrids in golf for the ultimate in protection during play or travel. Interchangeable tag system allows you to put the right number on the right club - gone are the days of club specific covers. Limited 1-year warranty. Available in 3 colors. **\$14.99 each.**

- ICGHM001 - Black
- ICGHM006 - Red
- ICGHM017 - Brushed Metal



Golf's Finest Hybrid Wood Covers

Each easy on/off wood cover comes with a set of 2 snap-on interchangeable numbers that allow you to create a 1, 2, 3 or 4 cover. Keeps high-end drivers safe and protected. Premium, leather-like feel and appearance is lightweight and durable. Fits left or right handed clubs. Easy on/off design. Limited 1-year warranty. Available in 5 colors.

- \$17.99 each.**
- Cover with #1 & #2 Snap: WCFH12
- Cover with #3 & #4 Snap: WCFH34

Golf's Finest Wood Covers

Premium CG Wood Covers/Custom Wood Covers

World-renown for our quality and design, these easy on/off wood covers are both lightweight and durable. Premium leather-like feel and appearance keep high-end driver heads and shafts safe and protected. Heavy-duty zipper. Fits left or right handed sets and most fairway woods. Limited 1-year warranty. Available in 5 colors in 6 denominations.

Wood Covers with custom embroidery all sizes \$29.99 ea

- CLUB GLOVE® Wood Covers with CG embroidery:
- #1X Oversize Driver (up to 500cc) WCDX \$19.99
 - #1 Driver (up to 470cc) WCD1 \$17.99
 - #3 Fairway WCF3 \$17.99
 - #5 Fairway WCF5 \$17.99
 - #7 Fairway WCF7 \$17.99
 - X Fairway WCFX \$17.99



Covers & Accessories

1
Diamond monogram

JTS
Monogram block
3

JTS
Monogram script
5

JOHN T. SMITH
Name block
7

John T. Smith
Name script
X

Victoria National
Golf Club

TUSCON COUNTRY CLUB

Bob Lewis
3

• High quality zipper

• Ultra-luxurious lining for ultimate protection



Custom embroidery shown



PRO grade

Covers & Accessories

Neoprene Premium Iron Covers

Iron covers perform best when they are properly sized for your specific clubs. These premium iron covers have been custom fit to the most widely used irons in golf for the ultimate in protection during play or travel. 9-piece set: (3, 4, 5, 6, 7, 8, 9, PW, SW) available in 7 colors.

Regular ICNR9 or Oversize ICNX9 \$29.99

3-piece set available in black.

Regular I3NR1 or Oversize I3NX1 \$11.99

Regular I3NRW or Oversize I3NXW \$11.99

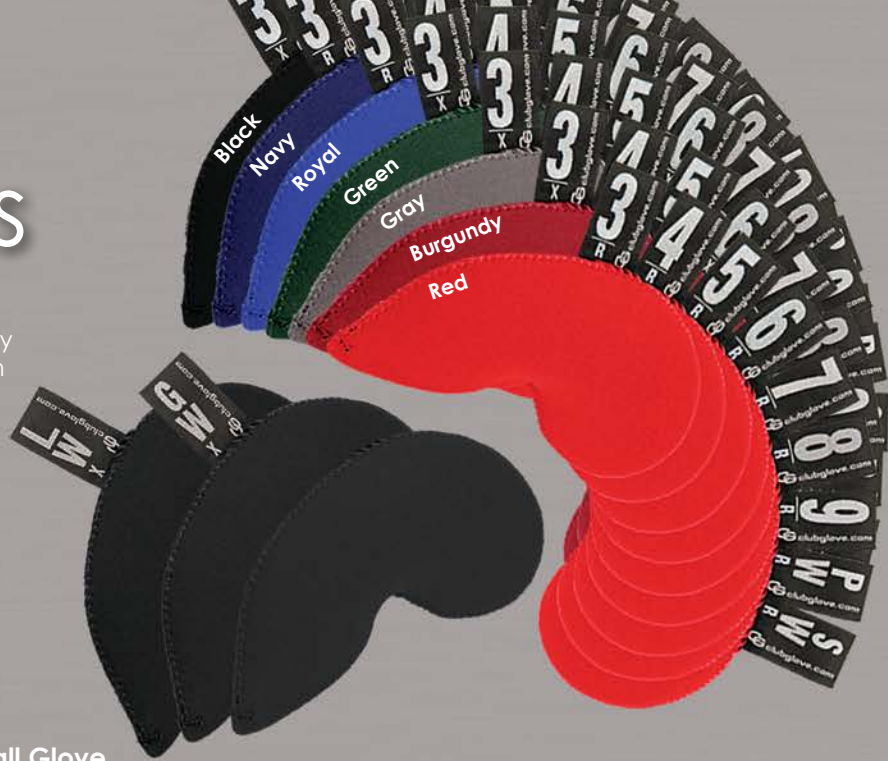

3-Ball Glove

Mini neoprene or nylon pouch holds 3 golf balls. Dual zippers allow easy entry to either side for quick access to your favorite ball. Can also hold keys, cell phones and other small items. Durable belt hook. Customization available. 2" H x 2" W x 5" D

A. Neoprene: BGNS3 \$7.99

B. Nylon: INBG \$9.95

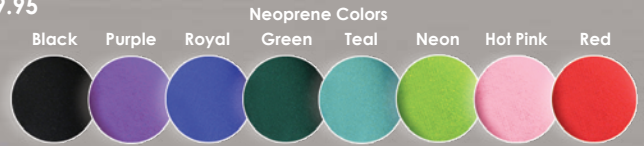
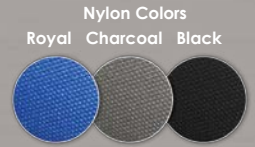

Deluxe Neoprene Putter Covers

Putter covers perform best when they are properly sized for your specific clubs. These premium putter covers have been custom fit to the most widely used putters in golf for the ultimate in protection during play or travel.

C. Deluxe Blade available in 5 colors. PCNDB \$8.99 ea

D. Mallet available in black. Regular PCNRM \$5.99 Oversize PCNXM \$5.99

E. Blade available in black. Regular PCNSB \$5.99 Oversize PCNXB \$5.99



Gloveskin®

Brushed Metal

Black

Red

F

G

H

I

J

K

L

Gloveskin® Premium Iron Covers

These iron covers will protect your club head and hosel and maintain that new look many players desire and are a must for forged irons. Soft and sleek leather-like feel and appearance, these are by far the most superior iron covers you will find. Compact and lightweight, they easily fit into your pocket while hitting. Fits left or right handed sets. Available in 3 colors.

A. 9-piece set: (3, 4, 5, 6, 7, 8, 9, PW, SW)

Regular ICGR9 \$39.99

Overize ICGX9 \$39.99

B. 3-piece set: (LW, GW, blank)

Regular I3GR \$15.99

Overize I3GX \$15.99

Gloveskin® Premium Putter Covers

The most popular putter covers in golf feature a neoprene leather-like feel that is soft and sleek. Innovative design allows for easy slide on/off and fit in your pocket while putting. Available in 3 colors and 4 styles.

H. XL Futura putter style

RH PCGFM or LH LHGFM \$13.99

I. 2-Ball Mallet putter style

RH PCG2M or LH LHG2M or Center Shaft PCG2C \$13.99

J. Mallet putter style

RH PCGRM or LH LHGRM \$10.99

K. Overize Blade PCGXB \$10.99

L. Regular Blade PCGRB \$10.99



Custom embroidery



PRO grade

Liven Up Your Tournament

CLUB GLOVE® Shopping Spree Card

Not sure which one of our outstanding products to pick for your tournament gift? Want to give your players more to choose from? The Shopping Spree Card is the perfect choice! Available in any amount. Call your rep today to learn how you can double your perceived value and wow your members and guests with the Shopping Spree Card. Comes in deluxe soft touch 9" W x 5.75" H envelope with a copy of our mini-catalog.



Available with or without a customized note to your client or members



Double Your Perceived Value!

SCHEYDEN®



"Scheyden's dedication to quality shows from tip to temple. From their titanium frames to their hand-ground mineral glass lenses, Scheyden delivers the best in optical quality and clarity."
- John Mallinger, Pro Golfer

Tournaments

West Coast Trends, Inc., makers of **CLUB GLOVE®**, is proud to introduce Scheyden Precision Eyewear. Scheyden specializes in precision eyewear for use on land, air or sea. High quality materials including titanium, hand-ground mineral glass and cedar rolled composite ensure that your Scheydens will provide a lifetime of optical clarity with unrivaled comfort. Call today to see how Scheyden can help make your next tournament a soaring success. See more at Scheyden.com

Fixed Gear - Titanium Frames



MUSTANG FG MU Size: 60.5 | 16



ALBATROSS FG AL Size: 60 | 16

Fixed Hybrid - Composite Frames



PANORAMA FH 25 Size: 66 | 19



JET-A FH 30 Size: 63 | 19

"Using Scheyden eyewear for our member guest tee gift was the hit of the tournament. Our members and guests couldn't figure out how they got so much bang for their buck. You have to try them on to appreciate how good they really are." - Rob Clark, PGA Pro, The Legends of Huntsville



Call Today for Special Tournament Pricing! 800.851.2758 | 714.843.1975

Roll Like A Pro, Play Like A Pro



The Exclusive
Manufacturer of
The World's Only
Self-Balancing Luggage
Train Reaction®
integrated luggage connecting system



Artwork, designs, and trademarks embroidered on the products within this catalog are reproduced only as examples of the type and quality of embroidered products available. They are not intended to represent that the products are either endorsed by, or produced for the owners of the artwork, design, or trademark. *No returns on personalized items. All prices, specifications and information within this catalog subject to change without notice. © CLUB GLOVE 2015

West Coast Trends, Inc. Makers of Club Glove®
17811 Jamestown Lane, Huntington Beach, CA 92647
714.843.9288 | 800.736.4568 CLUBGLOVE.COM