

dye[®]

MES

ADVANCED PERFORMANCE MARKER

MOS^{AIR}
METHOD OPERATING SYSTEM AIR

FL-21
Fuse Legacy



CFC CABLE FREE
CHARGING

2018 OWNER'S MANUAL

THE CHOICE OF CHAMPIONS



INCLUDED WITH YOUR M3S MARKER

2 Piece barrel kit

(1) 14" ULs Barrel tip

(1) .684" UL Barrel back

(1) .688" UL Barrel back

• Allen tool set

• 1/4oz slick lube

• Parts kit

• Barrel sock

• Customer support passport

• Software upgrade cable

• Charging cable

• Digital copy of owner's manual

• Warranty card



**ULTRALITE
45 FRAME**
PATENTED



**INTERNAL PRESSURE
SENSOR**



**RECHARGEABLE
BATTERY**



**e-VOKE
COMPATIBLE**



**EYE PIPE
BREECH SYSTEM**
PATENTED 3RD GENERATION



**CFC CABLE FREE
CHARGING**



**QUICK
RELEASE
BOLT**



**LOCKDOWN2
CLAMPING
FEEDNECK**



**O-RINGS
COLOR CODED**



**MAG-REACH
TRIGGER**



**PRISM
INTERFACE
SYSTEM**



**RECHARGEABLE
BATTERY**



**CONTROL
JOYSTICK**



**LOWPROFILE
DESIGN**



GAS-THRU



**SHIFTPORT
ASA**



H6 HYPER 6S PRO



**UNIVERSAL
SERIALBUS**



WARNING

IMPORTANT SAFETY INSTRUCTIONS AND GUIDELINES

- The M3s marker is not a toy. Misuse may cause serious injury or death.
- Please read, understand and follow the directions in the M3s owner's manual.
- Eye protection that is designed specifically for paintball and meets ASTM/CE standards must be worn at all times by user and persons within range.
- Recommend 18 years or older to purchase. Persons under 18 must have adult supervision.
- Always treat the M3s marker as if it were loaded and able to fire.
- Only use compressed air or nitrogen gas in the M3s marker. **DO NOT USE CO₂**.
- Do not exceed 850 psi input pressure.
- Ensure all screws and components on M3s are tightened and secured before gassing up.
- Always chronograph the M3s marker before playing paintball.
- Never shoot the M3s marker at velocities in excess of 300 feet per second, or at velocities greater than local or national laws allow.
- Never look into the barrel or breech area of the M3s when the marker is switched on and able to fire.
- Always fit a barrel-blocking device to your M3s when not in use on the field of play.
- The owner's manual should always accompany the product for reference or in the event of resale and new ownership.
- Do not point the M3s marker at anything that you do not intend to shoot.
- Do not shoot at people, animals, houses, cars or anything not related to the sport of paintball.
- Do not fire the M3s without the FL-21™ bolt locked in place.
- If you read these instructions and do not fully understand them or are unsure of your ability to make necessary adjustments properly, call DYE or your local pro shop for help.

DSR OWNER'S MANUAL

TABLE OF CONTENTS

IMPORTANT SAFETY INSTRUCTIONS AND GUIDELINES	PAGE 01
QUICK REFERENCE	PAGE 02
PRISM INTERFACE	PAGE 03
METHOD OS (MOS)	PAGE 04
TRAINING MODES	PAGE 10
SOFTWARE & BOOT SCREEN UPGRADE.....	PAGE 11
POWER SUPPLY	PAGE 13
EDGE1 TRIGGER ADJUSTMENT.....	PAGE 14
STICKY GRIP	PAGE 15
FL-21™ BOLT.....	PAGE 16
HYPER6S PRO™	PAGE 18
SHIFTPORT ASA	PAGE 20
EYE PIPE ANTI CHOP EYES/BALL DETENTS.....	PAGE 22
TROUBLE SHOOTING GUIDE	PAGE 23
M3S MENU TREE	PAGE 25
EXPLODED VIEW	PAGE 26
WARRANTY INFORMATION	PAGE 27

QUICK REFERENCE

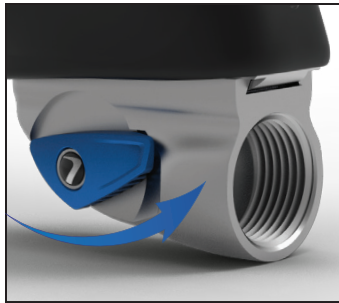

AIR SUPPLY

The M3s should be operated using air/nitrogen gas only. This air needs to be supplied at a regulated pressure of no more than 850 psi.

GASSING UP YOUR M3S

Screw in your air system to the Airport and rotate the side lever counter clockwise until the internal stop is reached.

TURNING ON YOUR M3s

Power up M3s marker.

Note: Be sure to fully charge your M3s marker before first use.

To power on your M3s marker depress and hold the joystick located on the back strap of the grip frame, for 2 seconds. The LED will illuminate and the boot up screen will be displayed on the OLED.

The eye system is automatically powered on during boot up.

To turn the eyes on or off, press and hold the joystick downward for 2 seconds.



Blue: Boot sequence

Red: Breech is clear, no ball (eyes on)

Green: Ball in breech, ready to fire (eyes on)

Blinking Red: Eyes are off

Blinking Green: Eye failure

HOPPER

To get the best performance out of your M3s, it is recommended that you use a motorized loader. Preferably, the R-2™ Loader.

⚠️ WARNING

- A LOW BATTERY WILL NOT BE ABLE TO POWER BOTH THE ACE EYE AND THE TRIGGER SWITCH, CAUSING ACE EYE FAILURE.
- IF THE BATTERY IS LOW, IT MAY NOT BE ABLE TO POWER THE SOLENOID CORRECTLY. THIS WILL AFFECT THE M3S'S VELOCITY, CAUSING IT TO BECOME INCONSISTENT AND/OR LOW.

BATTERY CHARGING INSTRUCTIONS

The M3s marker uses a rechargeable battery.

To access the M3s's charging port open the dust cover labeled USB on the upper left side of the grip. Lift and rotate the cover out of the way.

In order charge your M3s marker, simply use any standard micro USB cable and power supply. A micro USB cable is provided with the marker.

Plug the full size USB end of the cable into any standard power supply adapter (car charger, wall charger, computer, etc.) See page 12 in manual for complete battery detail.

LED LIGHT COLOR INDEX-CHARGING

Blinking Blue: Charging up to 95%

Blinking Green: Charging up to 95% - 99%

Solid Green: 100% charged

BASIC VELOCITY ADJUSTMENT

The velocity is CONTROLLED through the Hyper6s Pro™ regulator. The Hyper6s Pro™ is preset from the factory at approximately 115 psi. This pressure setting should have the marker shooting at about 285fps. Your paint-to-barrel fit will also have a noticeable effect on your velocity.

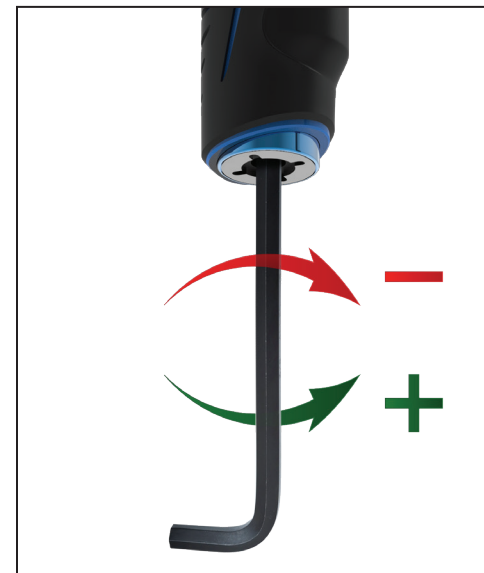

You can adjust your velocity through the Hyper6s Pro™ regulator, located in the fore grip. To adjust the velocity, insert a 3/16" Allen wrench into the bottom of the fore grip.

Turning the Allen wrench clockwise, or in, will lower the output pressure, decreasing the velocity. Turning the adjustment screw counterclockwise, or out, will raise the output pressure, increasing the velocity.

THE PRISM INTERFACE AND METHOD OS AIR

The massive 1 inch, full color, high resolution OLED screen, combined with the 5-way Joystick provides simple control of the M3s. Intuitive navigation gives you access to DYE's Method Operating System. Prism is an intuitive interface, for an advanced operating system. The joystick control index will help you become quickly familiarized with interfacing with the Method Operating System.

Dye's new MOS gives the operator unparalleled access to precision tuning, vital performance feedback, and service reports. Not only does the new operating system take the M3s's performance to the next level, it also actively tracks important sub systems to make sure our marker is kept running at its best. Customize nearly every aspect of the M3s to your exact playing specifications. With 5 different customizable player profiles you'll be ready for any environment, and rule book.



5-WAY
JOYSTICK
CONTROL
INDEX

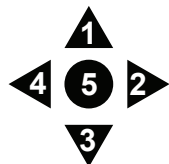

	PLAY MODE		PROFILE SELECTION DISPLAY		SETTING ADJUSTMENT MENUS	
1	ENTER PROFILE SELECTION DISPLAY (HOLD FOR 2 SEC)		SCROLL UP (TAP)	RETURN TO PLAY MODE (HOLD FOR 2 SEC)	VALUE UP (TAP)	EXIT TO PROFILE SELECT (HOLD FOR 2 SEC)
2	GAME TIMER START/STOP (TAP)	GAME TIMER RESET (HOLD FOR 2 SEC)	NO FUNCTION		SCROLL RIGHT THROUGH MENU (TAP)	
3	EYES ON/OFF (HOLD FOR 2 SEC)		SCROLL DOWN (TAP)	VALUE DOWN (TAP)		
4	SYSTEMS CHECK (TAP)	SHOT TRACKER RESET (HOLD FOR 2 SEC)	NO FUNCTION		SCROLL LEFT THROUGH MENU (TAP)	
5	POWER ON/OFF (HOLD FOR 2 SEC)		SELECT PROFILE (TAP)	ENTER SETTING ADJUSTMENT MENU (HOLD FOR 2 SEC)	SELECT SETTING TO ADJUST (TAP)	SAVE VALUE (TAP)



POWER ON

Press and hold the center of the joystick for 2 seconds. The M3s will boot up, during the boot up process the boot screen will be displayed. After boot up, the board will enter the Play screen. The gun is now ready to be fired.

POWER OFF

Press and hold the center of the joystick for 2 seconds. The board will automatically shut down if the marker is not used for a set period of time. You can adjust the auto shut off time. See Auto Shut Off under Data Settings (page 7).

LED LIGHT COLOR INDEX

Blue: Boot sequence

Red: Breach is clear, no ball detected inside the M3s (eye is on)

Green: Ball in breach, ready to fire (eye is on)

Blinking Red: Eye is turned off

Blinking Green: Eye failure, eye is blocked or dirty (see M3s Eye, page 22).

To turn the eyes off, press and hold the joystick down for 2 seconds until the light begins flashing red.

NOTE: You are able to force the M3s to fire with eyes on and no ball in the breach. To do so, depress and hold the trigger for 1 second.

BOOT UP SCREEN

The boot screen will be displayed for 4 seconds. You can select between 4 pre-set screens or you can download your own personal boot screen. See the Select Boot Screen section under Data settings (see page 6).

SOFTWARE VERSION

The software version is displayed at the bottom of the standard boot screens. The software version will not be displayed on custom boot screens.



METHOD OPERATING SYSTEM (MOS)



PLAY SCREEN

You are able to select between 3 play screens depending on what information you wish to have displayed. Option 1 is the default setting, for more play screen options see Select Play Mode Screen under Data Settings (page 6).

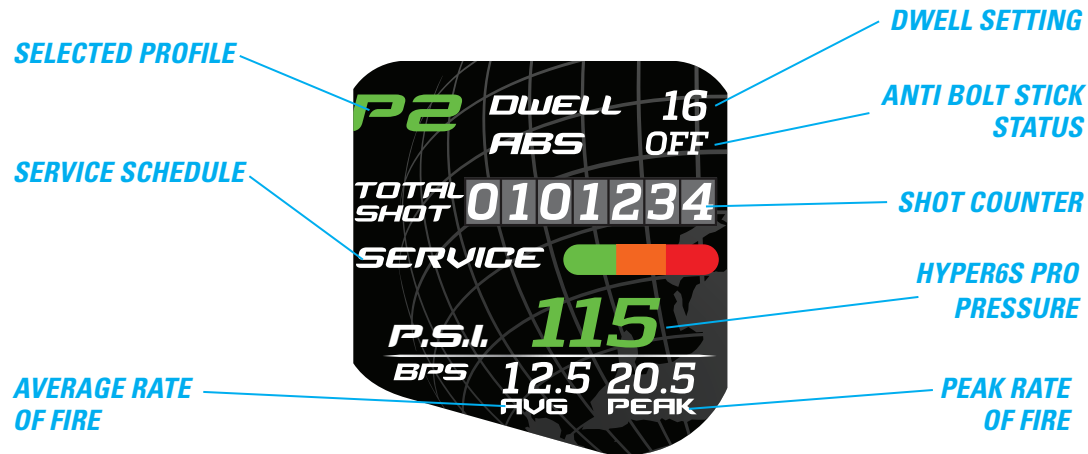

SYSTEMS CHECK SCREEN

From the Play screen you can quickly access the Systems Check screen by pressing the Joystick LEFT. The Systems Check screen gives you a quick overview of your gun's primary operating settings and service status. The screen will automatically return to the Play Screen after 10 sec.



PROFILE SELECTION

To enter into Profile Selection screen press and hold the joystick UP for 2 seconds. This will take you to the profile selection screen. Scroll up and down to hi-lite the profile you wish to select. Press the CENTER of the joystick to select the highlighted profile. The selected profile is indicated in the upper right corner.

There are 5 fully adjustable profiles and 1 locked Factory default profile. Once you have selected your desired profile press and hold UP on the joystick to return to Play Mode screen, or press and hold the CENTER of the joystick to enter into the Settings Adjustment menu.

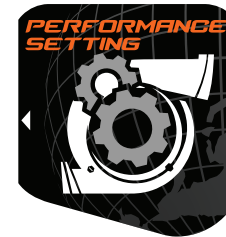

SETTINGS ADJUSTMENT

Enter settings adjustment menu from the profile selection screen, after selecting the profile you wish to adjust press and hold the CENTER of the joystick. Scroll left and right to display either Performance or Data settings. Press the center of the joystick to select the displayed category. Settings are separated into two categories: Performance and Data.

PERFORMANCE SETTINGS will affect the M3s's shooting performance. These settings are not adjustable when the tournament lock is on.

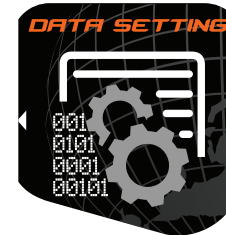

DATA SETTINGS are for reviewing collected data, display controls, and system parameters.

Scroll left or right to display menu options. Press the center of the joystick to select the displayed menu option. Once selected the setting's values can be adjusted using the joystick. Once the desired value or setting has been entered Press the center of the joystick to save the value, and continue scrolling through menu options.



NOTE: To exit scroll till the "exit" screen appears and then press the center of the Joystick. At any point you can also press and hold the Joystick UP to exit to the Profile selection screen.



PERFORMANCE SETTINGS



GAME CLOCK

Set countdown game timer. (Default 2:30) To operate game timer in play mode press the joystick right to start and stop the game timer, Press and hold the joystick right for 2 seconds to reset.



TRIGGER SENSITIVITY

Values 1 - 20 (Factory Default 3)
Trigger sensitivity is the amount of time that the trigger must be released before the next trigger pull is allowed.



RATE OF FIRE

Values 5.0 - 18.0 (Factory Default 12.5 bps)
The ROF setting is used to set the maximum rate of fire. ROF is adjustable by 1/10th per second.



FIRE MODE

(Factory Default Semi-Auto)
Choose between 5 different fire modes:
Semi-Auto: One trigger pull = one shot
Millennium/ NXL Ramp: Compliant with Millennium series rules
Burst: Compliant with PSP series rules
Full Auto: Continuous fire with trigger depressed after 3rd trigger pull
Outlaw: Customize PPS, pulls to start, burst of ramp. Select Outlaw mode and follow prompts to customize fire mode

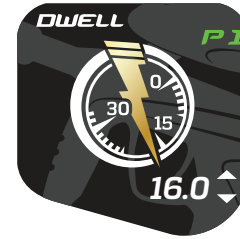

DWELL

Values 12 - 20 (Factory Default 16)
Dwell is the amount of time, in milliseconds, that the solenoid is activated for each shot. Setting the dwell too high will decrease max rate of fire, setting the Dwell to low will not be sufficient to ensure the optimal velocity.



ABS

Anti Bolt Stick - Values off-10(Factory Default 6)
ABS is the amount of time, in Milliseconds, that the dwell is increased for the first shot after a period time of no shots. This is to help prevent bolt stick, and first shot drop off.



ABS WAIT TIME

Values 10-90 seconds in increments of 5 sec (Factory Default 20)
ABS wait time is the time, in seconds, that must expire between shots before the ABS activated.



EYE DELAY

Values 01-20 (Factory Default 3)
Eye Delay is the amount of time, in milliseconds, that the eyes must read a paintball in the breach before the M3s is allowed to fire. This helps to prevent ball chop in the breach. It is recommended to increase the Eye Delay for slower feeding loaders.



DATA SETTINGS



CUSTOMIZE PROFILE NAME

(Factory Defaults P1-P5, Factory)

Personalize each Profile with a distinct name to help identify them. Move the joystick up and down to scroll through letters numbers and special typescript. Move the joystick left and right to change the next character.

ABCDEFGHIJKLMNOPQRSTUVWXYZ abcdefghijklmnopqrstuvwxyz
 ! " # \$ % & ' () * + , - . / : ; < > = ? @ [] \ ^ _ ` ' %
 0 1 2 3 4 5 6 7 8 9

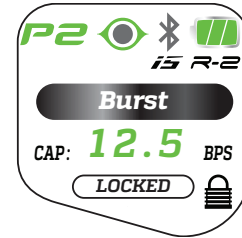
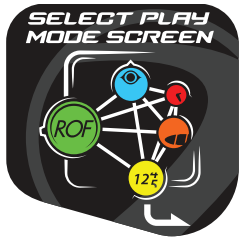

SELECT PLAY SCREEN

Values 1-6 (Factory Default 1)

Select the best play mode screen for your style of play.

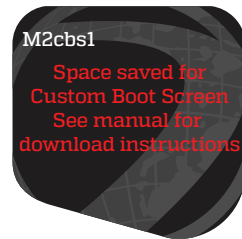

SELECT BOOT SCREEN

Select your favorite Boot screen from the 4 pre-set options, or download your our own personalized boot screen. For directions on how to download a custom boot screen see the programming section on page 12. All standard boot screens display software version.



DATA SETTINGS



SHOT TRACKER

The shot tracker helps you monitor your paint consumption during a game or a day. Choose between countdown and sum track. The Shot tracker can be set to zero from the Data settings menu, and reset from the play mode screen. To reset from the Play mode screen press and hold the joystick left for 2 seconds. When you select countdown track in the data settings menu you will be prompted to enter your how much paint you will start with. Tap joystick up and down to adjust. When desired count is displayed tap center of joystick to save. Once you exit to the play screen every shot will be tracked.



TOTAL SHOT COUNTER

The total Shot Counter cannot be re-set, it is used to monitor systems and service schedules. The total Shot Counter also indicates that the gun was tested at the factory prior to shipping. It is also a strong indicator of how much use the M3s has seen in its life.



POWER OFF OPERATION

Select how to power your M3s off. How do you prefer to power down your M3s? Choose between double tap or the standard press and hold

QUICK DRAW POWER UP

Under the right side of the UL sticky grip you will find a 2 button dip switch. Dip switch #1 controls the quick draw power up feature. With Dip switch #2 in the down position your gun is ready to fire the moment the LED lights up.

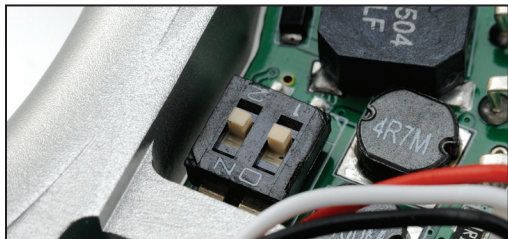

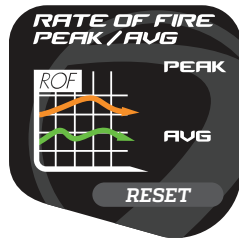

RATE OF FIRE PEAK/AVERAGE

The peak rate of fire is the shortest amount of time between any two shots in a stream of shots.
The average rate of fire is the average ROF in a stream of shots.



SCREEN BRIGHTNESS

Control the screen brightness for better visibility of the screen



SCREEN SLEEP

Values 15 sec - 10 min (Factory Default 1 min)
The screen will go to sleep after a predetermined amount of time. This is to conserve battery life when playing. To activate the screen tap the Joystick in any direction.



AUDIO

(Factory Default ON)
turn the sound off or on for navigation . The game timer alarm cannot be turned off.



AUTO SHUT OFF

Values 10 – 60 min (Factory Default 10 min)
The board will automatically shut down if the marker is not used for a set period of time. You can adjust the shut off time.



PRESSURE GAUGES

The M3s is equipped with an internal pressure sensor that monitors the operating pressure in the marker. Once the Gauge screen is displayed press the center of the joystick to get a live reading. The screen will read "Processing" before displaying the operating pressure. When done, press the center of the joystick, and continue to scroll through the Data Settings menu.

- To exit the live reading screen press the center of the Joystick again.
- Operating pressure will vary depending on weather conditions, paint size, and desired velocity.
- Use the color coded gauge to help keep your M3s within standard operating levels.
- Operating Pressure should be set between 90 psi and 140 psi.
- For adjustment instructions see page 18.





SERVICE SYSTEM

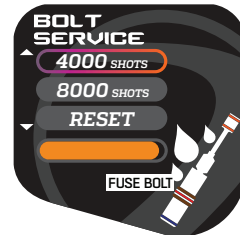

The Service system tracks shots fired and when the major components of your marker need to be serviced. You can adjust your service schedule based on weather and playing conditions. More severe conditions will require service more often.

To adjust service schedule, scroll to desired service screen. Press the joystick to unlock the screen for adjustment. Scroll up or down to desired service schedule. Press joystick to select and save.



When one or more systems are due for service a red "Service" icon will flash over your play mode screen.

Access the Service System to view what needs service. After service is performed reset the components system monitor.

To reset any of the service schedules, scroll to the desired service screen, and press the Joystick to unlock the screen for adjustment. Scroll Down to "Reset" and Press the joystick. This will reset the service monitor for the displayed system. If you perform service prior to receiving a service alert you can re set the service monitors at that time as well.

⚠️ WARNING

BEFORE SERVICING YOUR MARKER:

- MAKE SURE TO REMOVE THE BARREL FROM THE M3S.
- MAKE SURE YOUR HOPPER IS REMOVED FROM THE M3S.
- MAKE SURE THERE ARE NO PAINTBALLS IN THE BREECH OF THE M3S.
- ALWAYS RELIEVE ALL RESIDUAL GAS PRESSURE FROM THE M3S BEFORE COMMENCING ANY DISASSEMBLY.
- THE M3S CAN HOLD A SMALL RESIDUAL CHARGE OF GAS, AFTER THE AIR SUPPLY HAS BEEN REMOVED. ALWAYS DISCHARGE THE MARKER IN A SAFE DIRECTION TO RELIEVE THIS RESIDUAL GAS PRESSURE.



ZERO-START COUNT

- 1/5
- 2/5
- 3/5
- 4/5

SERVICE DUE

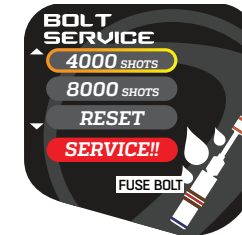

BOLT 4,000 or 8,000 shots
 HYPER6S PRO 75,000 or 100,000 shots

NOTE: You are given the option to deactivate the Service System. If the Service System is deactivated you will not be alerted when service is due. We highly recommend you keep Service System activated in order to help ensure the M3s gets regular maintenance.

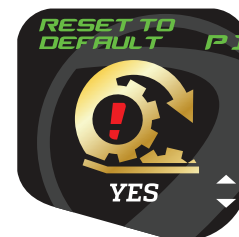

RESET TO DEFAULT

At any time you can reset the profile you are in to Factory Default settings.

⚠️ WARNING

- THE M3S IS NOT WATER RESISTANT. EXCESS MOISTURE WILL CAUSE DAMAGE TO ELECTRONIC PARTS.
- KEEP THE BOARD AND ALL ELECTRICAL COMPONENTS CLEAN OF DIRT, PAINT AND MOISTURE.
- TO CLEAN THE BOARD, USE CANNED AIR. IF A MORE AGGRESSIVE CLEANING METHOD IS NEEDED, LIGHTLY SCRUB THE COMPONENTS WITH A SOFT, DRY BRUSH. HEAVY SCRUBBING WILL DAMAGE THE BOARD.



TRAINING MODES

The M3s has 3 training drills to help you hone your skills. Access the training mode in the settings adjustment menu. Scroll left or right to reach the Training Mode screen. Press the Center of the joystick to select. Scroll Left or Right to select the training mode of your choice. With the Desired Drill screen displayed press the center of the joystick to start the drill.

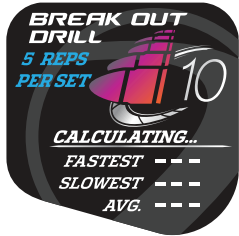

BREAKOUT DRILL

Designed to help improve speed and accuracy when standing and shooting from the starting box.

- Line up at the starting box, with a designated target down field. Press the joystick and wait for the beep.
- On the beep turn, aim, and fire 10 shots (the M3s will only allow 10 shots to be fired). When you reach 10 shots the M3s will beep twice.
- On the double beep reset at the starting box and wait for the next single beep.
- Repeat 5 times to complete 1 set.
- At the end of the 5th rep the M3s will beep 3 times and display your fastest, slowest, and average response time it took you to turn and shoot 10 balls.

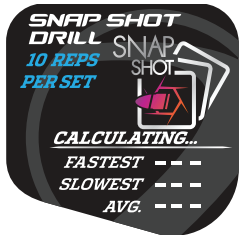

SNAPSHOT DRILL

Designed to improve speed, accuracy, and muscle memory when snap shooting from behind cover.

- Set up behind any bunker with a designated target down field. From behind the bunker press the joystick and wait for the beep.
- On the beep lean out from behind cover, aim, shoot one ball (the M3s will only allow one ball to be fired), and return to cover.
- Wait for the next beep and repeat.
- You will repeat 10 times to complete one set.
- At the end of the 10th rep the M3s will beep 3 times, display your fastest, slowest, and average time it took you to shoot one ball.

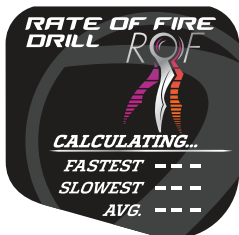

RATE OF FIRE DRILL

Designed to help with trigger speed. This drill is to be used without paint or air. Practice your finger speed without causing additional wear to your marker.

- Wait for beep.
- Pull trigger as fast as possible.
- The drill will track how fast you can pull the trigger, and report after each string of shots your fastest, slowest, and average BPS during the string.



TRAINING MODE STATISTICS

To see how you are progressing on your training you can review your last 10 sets for each drill under Training Mode Statistics.

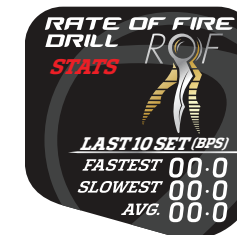
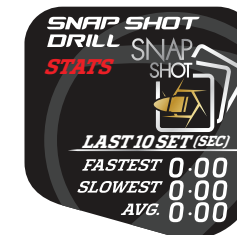

TOURNAMENT LOCK

Under the right side of the UL sticky grip you will find a 2 button dip switch. Dip switch #2 controls the tournament lock. On the play mode screen there is a pad lock icon located in the lower right corner. This pad lock icon indicates whether the tournament lock is engaged or not.

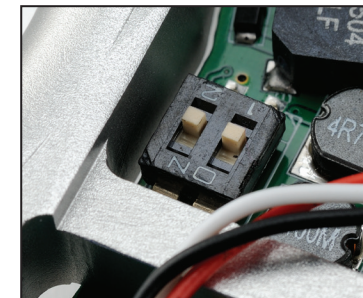

When the tournament lock is engaged settings that could affect the gun's performance will be labeled "locked" and will not be able to be adjusted until the tournament lock is turned off.

Note: the #1 dip switch has no function.



Periodically DYE will release new updated software for the M3s. The new software will be available on www.dyeM3s.com, and www.dyepaintball.com

TO UPDATE YOUR M3S'S OPERATING SYSTEM FOLLOW THESE SIMPLE DIRECTIONS.

- Save the new operating software to your Customer Support Passport, or any standard flash drive.
- Plug the flash drive into the upgrade cable (supplied with your M3s).
- Plug the cable into your M3s, use the same port you use to charge your battery.
- To access the M3s's micro USB port open the dust cover labeled USB on the upper left side of the grip. Lift and rotate the cover out of the way.

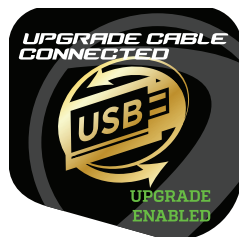

- Power on your M3s, the USB sync screen will be displayed.
- Press the center of the joystick to initiate the upgrade process.



- Scroll down and select upgrade software.



- Confirm you wish to upgrade the software.



- The system will begin to upgrade the software.
- This may take several minutes.



- Do not unplug the cable until you are prompted to do so.



- Once the cable has been unplugged the board will automatically power off. This signifies the upgrade is done, and the M3s is ready for use.



CUSTOM BOOT SCREEN INSTALL



You can customize the boot screen on your M3s with any photo you like. The full color provides remarkable detail and image resolution. **Before you can download a photo onto the board it will first need to be converted to a .bmp file sized 128 x 128 pixels.** You can use any number of online programs. Depending on converter used, Bit Depth or color should be set at 24 (true color).

- Choose the file you wish to convert.
- Change size to 128 pixels x 128 pixels.
- Set Bit Depth or color at 24 (true color)
- Click convert file.
- **The .bmp files must be saved with specific file name so that the M3s can accurately identify and store them.**
Custom boot screen #1 FILE NAME = m3cbs1
Custom boot screen #2 FILE NAME = m3cbs2
Custom boot screen #3 FILE NAME = m3cbs3
- Each free boot screen space is labeled with the associated file name.
- Save new .bmp file to your Customer Support Passport or any standard flash drive.
- Plug the flash drive into the upgrade cable (supplied with your M3s).
- Plug the cable into your M3s, use the same port you use to charge your battery.
- To access the M3s's micro USB port open the dust cover labeled USB on the upper left side of the grip. Lift and rotate the cover out of the way.
- Power on your M3s, the USB sync screen will be displayed.
- Press the Center of the joystick to initiate the upgrade process.

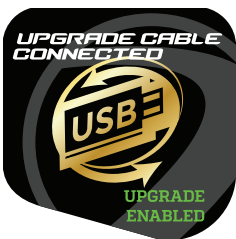

- Select Upgrade Custom Boot Screen.



- Confirm you wish to Upgrade Custom Boot Screen.



- The system will begin to download the file.



- Do not unplug the cable until you are prompted to do so.



- Once the cable has been unplugged the board will automatically power off. This signifies the upgrade is done, and the M3s is ready for use.
- Power up M3s. Access Select Boot Screen in the Data settings menu and select your new custom boot screen.

RECHARGEABLE BATTERY

The M3s comes standard with a lithium ion rechargeable battery. The battery is housed in the grip frame, on the right side under the sticky grip. There is no need to access the battery at any time. Charging is done through the micro USB port located on the upper left side of the sticky grip.

NOTE: Be sure to fully charge your M3s marker before first use.

BATTERY CHARGING INSTRUCTIONS

To access the M3s's charging port open the dust cover labeled USB on the upper left side of the grip. Lift and rotate the cover out of the way.

In order to charge your M3s marker, simply use any standard micro USB cable and power supply. A micro USB cable is provided with the marker.

Plug the full size USB end of the cable into any standard power supply adapter (car charger, wall charger, computer, etc.).

LED LIGHT COLOR INDEX-CHARGING

Blinking Blue: Charging up to 95%

Blinking Green: Charging up to 95% - 99%

Solid Green: 100% charged



WIRELESS INDUCTIVE CHARGING

The M3s can now be charged by wireless inductive charging. Simply set the M3s logo on the right side of the grip on DYE wireless charging base or any standard charging base.



LOW BATTERY

When the battery level drops below 30% the low battery alert icon will flash instead of the play screen. When this occurs the battery should be charged as soon as possible to prevent improper function.

BATTERY LEVEL CHART

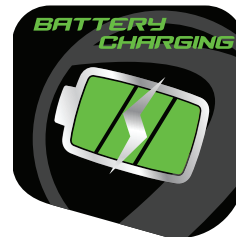

95% - 100%

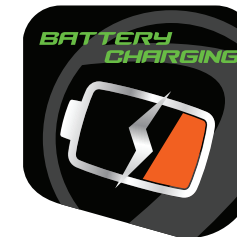

30% - 69%

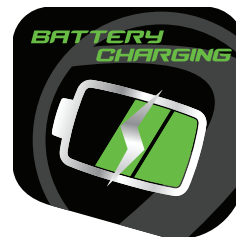

70% - 94%

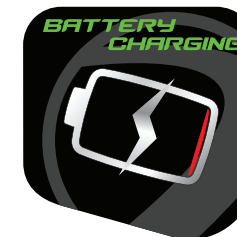

0% - 30%



⚠ WARNING

- A LOW BATTERY WILL NOT BE ABLE TO POWER BOTH THE ACE EYE AND THE TRIGGER SWITCH, CAUSING ACE EYE FAILURE.
- IF THE BATTERY IS LOW, IT MAY NOT BE ABLE TO POWER THE SOLENOID CORRECTLY. THIS WILL AFFECT THE M3S'S VELOCITY, CAUSING IT TO BECOME INCONSISTENT AND/OR LOW.

REACH TRIGGER ADJUSTMENT

ADJUSTING YOUR REACH TRIGGER

The trigger's travel and reach angle are fully adjustable so that you can fine-tune the trigger to your preference. You do not need to remove the frame or grip from the gun in order to make an adjustment to the trigger. There are two adjustment screws located on the left side of the Ultralite frame and one adjustment screw behind the trigger. The two screws on the side of the frame adjust the travel of the trigger. The one located behind the trigger will adjust the magnet's strength.

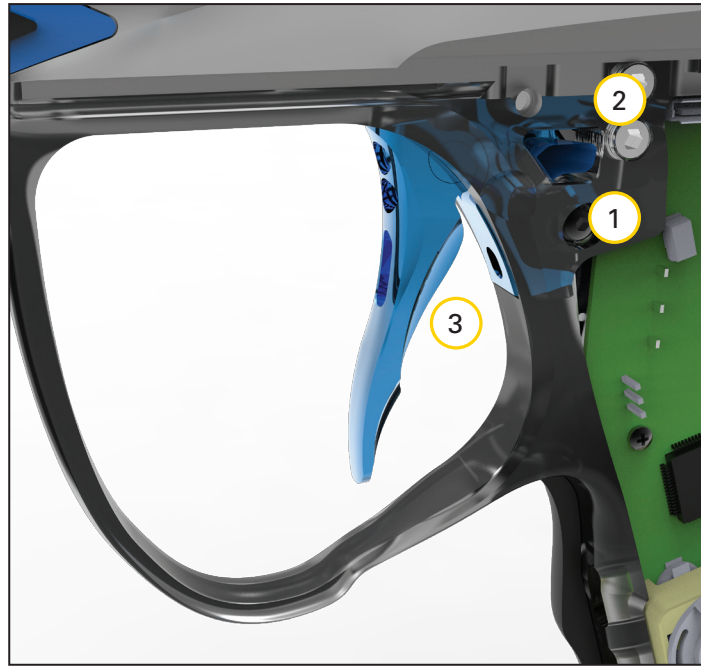

TO ADJUST TRIGGER TRAVEL

Use a 5/64" Allen wrench to make the desired adjustments.

- The bottom screw (1) controls the forward travel. Screwing it in will shorten the trigger's length of pull.

NOTE: IF THIS SCREW IS ADJUSTED TOO FAR, THE SWITCH WILL BE HELD DOWN AT ALL TIMES AND THE MARKER WILL NOT FIRE.

- The top screw (2) controls the over travel. By turning this screw you can adjust how far the trigger will travel after it reaches the firing point.

NOTE: IF THIS SCREW IS ADJUSTED TOO FAR, THE TRIGGER WILL NOT BE ALLOWED TO TRAVEL FAR ENOUGH TO DEPRESS THE SWITCH AND FIRE THE MARKER.

TO ADJUST MAGNET STRENGTH

- Use a 5/64" Allen wrench to make the desired adjustment. Insert the Allen wrench through the hole behind the trigger blade (3).
- To make the trigger pull stronger, turn the Allen wrench clockwise or in.
- To make the trigger pull weaker, turn the Allen wrench counterclockwise or out.

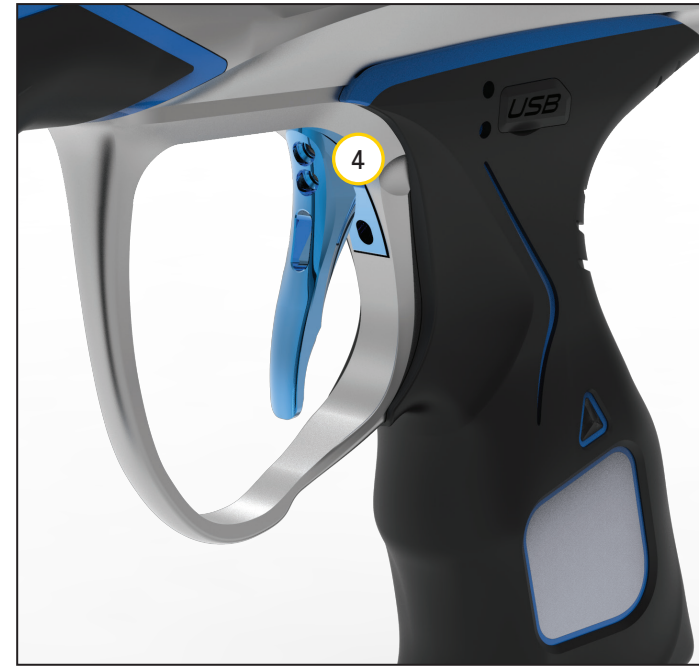

ULTRALITE REACH TRIGGER

The M3s has an external reach angle adjustment for the Ultralite trigger.

This adjustment changes the angle that the trigger blade sits without affecting the trigger activation point.

TO ADJUST TRIGGER REACH

To adjust, simply loosen the two 6-32 screws (4) using a 1/16" Allen wrench. You do not have to remove the screws from the trigger. Now the front of the trigger should rotate freely while the back of the trigger remains relatively stationary. When the desired trigger angle has been achieved, tighten the two 6-32 screws snugly. Be careful not to over tighten and strip the Allen wrench or screws.

!WARNING

BE SURE THE TRIGGER IS NOT ADJUSTED TO THE POINT WHERE IT IS TOO SENSITIVE AND MAY CAUSE ACCIDENTAL DISCHARGE OF THE MARKER.



STICKY GRIP REMOVAL



1. Pull the upper back corner of the grips away from the gripframe with your thumb. Allowing the rear tab to clear the frame.



2. While pulling with your thumb, use your index finger, to push the grips toward you.



3. The top portion of the grips should now be free from the gripframe.



4. Grab a hold of the inside of the grips with your fingers, using your palm on the outside surface of the grip.



5. Pull the grip forward and down.



6. In doing so, you will have released the last three locking tabs that are under the molded finger grooves.



7. Repeat instructions for reverse side and slide the grips off the frame.

INSTALL STICKY TOOL-LESS GRIPS

- Slide the Sticky grip on to the frame from the rear.
- Press the locking tabs under the molded finger grooves into the corresponding slots on the frame's front strap.
- Pull the top of the grip panel back in order to allow the front top locking hook to drop into the frame.
- Push the top of the grip panel forward to lock the top front hook into place.
- Press down on the upper rear corner to seat the upper retaining post into position.

FL-21™ ENGINE ASSEMBLY AND MAINTENANCE

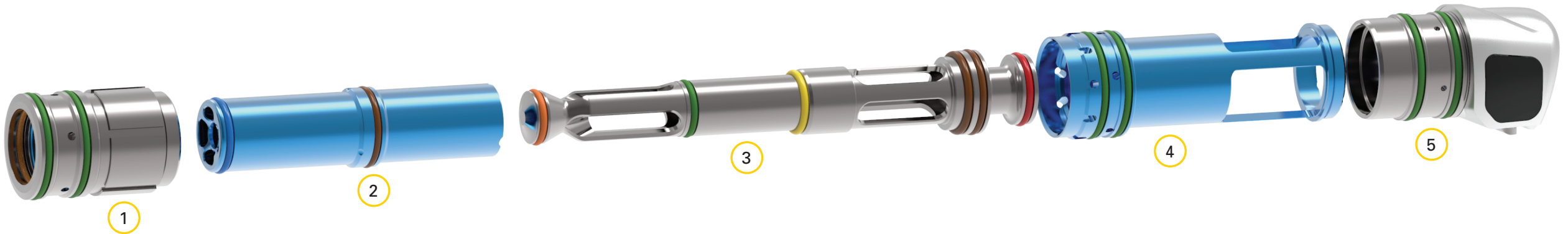

FL-21™ ENGINE OPERATION

To achieve top performance from your M3s, it is important to understand the basic operation of the M3s' F-21™ engine.

The design consists of 2 independently moving parts; the bolt and the valve.

The F-21 engine has 5 components:

- 1 Cylinder
- 2 Bolt
- 3 Valve Core
- 4 Top Hat
- 5 Valve Can

The air used to cycle the bolt is supplied to the front of the bolt sail through the holes at the front of the cylinder. To fire, this air is vented and air is added behind the second seal on the cylinder which pushes on the back of the bolt sail to drive it forward.

The F-21's valve system is the most advanced on the market. Air is supplied from the regulator through the holes in the valve can to the back of the valve sail. Air is selectively supplied to the shot chamber through the solenoid. Upon firing, the shot chamber provides air to fire the ball. When it drops below the designed pressure, the pressure behind the valve sail drives the valve forward trapping air in the shot chamber. **This highly advanced system is self-tuning, the board dwell setting should not need adjusted under normal circumstances.**

NOTE: LOW OR ERRATIC VELOCITY MAY BE DUE TO A LOW BATTERY NOT SUPPLYING AMPLE ELECTRICAL CURRENT TO THE SOLENOID. IN THIS CASE, CHARGE THE BATTERY.



⚠ WARNING

WHEN SERVICING YOUR MARKER:

- **MAKE SURE YOUR HOPPER IS REMOVED FROM THE M3S.**
- **MAKE SURE THERE ARE NO PAINTBALLS IN THE BREACH OF THE M3S.**
- **ALWAYS REMOVE THE AIR SUPPLY AND RELIEVE ALL GAS PRESSURE IN THE M3S BEFORE DISASSEMBLY.**
- **WHEN USING THE MARKER IN TEMPERATURES BELOW 50° FAHRENHEIT IT MAY BE NECESSARY TO LUBE THE FL-21™ BOLT MORE FREQUENTLY.**
- **THE M3S CAN HOLD A SMALL RESIDUAL CHARGE OF GAS, AFTER THE AIR SUPPLY HAS BEEN REMOVED. ALWAYS DISCHARGE THE MARKER IN A SAFE DIRECTION TO RELIEVE THIS RESIDUAL GAS PRESSURE.**



FL-21™ ENGINE ASSEMBLY AND MAINTENANCE

BOLT MAINTENANCE

Regular FL-21™ bolt maintenance is vital to the performance of the M3s. If the FL-21™ bolt is not kept well greased and the O-rings in good shape, the performance of the M3s will be greatly hindered.

The M3s software tracks how many shots the marker has fired, and will alert you when service is due. A red service icon will flash over the playing screen. See service system on page 8 for more info.

USE DYE UL SLICK LUBE TO GREASE THE M3S FL-21™ ENGINE AFTER EVERY 4,000 TO 8,000 SHOTS, DEPENDING ON PLAYING CONDITIONS. CHECK CONDITION OF O-RINGS. BE SURE THE FL-21 BOLT CAN MOVE BACK AND FORTH WITHOUT EXCESSIVE FORCE.

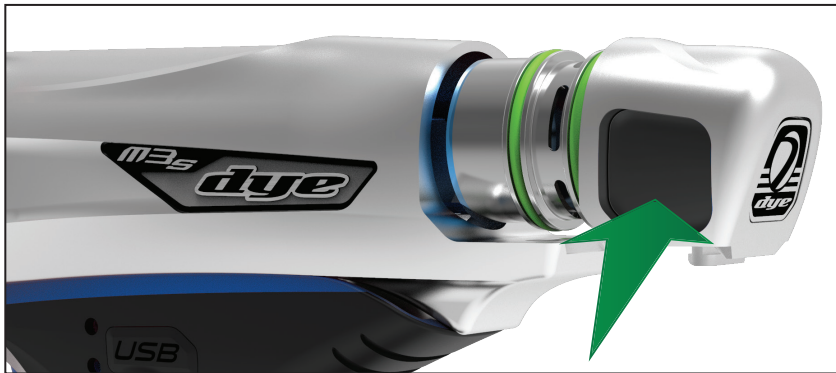

To remove the bolt, grab the bolt back cap with your right hand. Push the bolt release button, located on the left side of the bolt back cap, with your thumb. With the bolt release button depressed pull firmly back on the bolt.

BEFORE INSTALLING THE BOLT INTO THE MARKER, BE SURE ALL BOLT COMPONENTS ARE SCREWED TOGETHER SNUGLY.

If you do not grease the bolt, you will run the risk of damaging O-rings. This will create excessive friction and drag on the bolt, ultimately resulting in breaking the bolt. When greasing the M3s FL-21™ bolt, pay special attention to all O-rings that are on the bolt and that ride on a surface of the bolt.

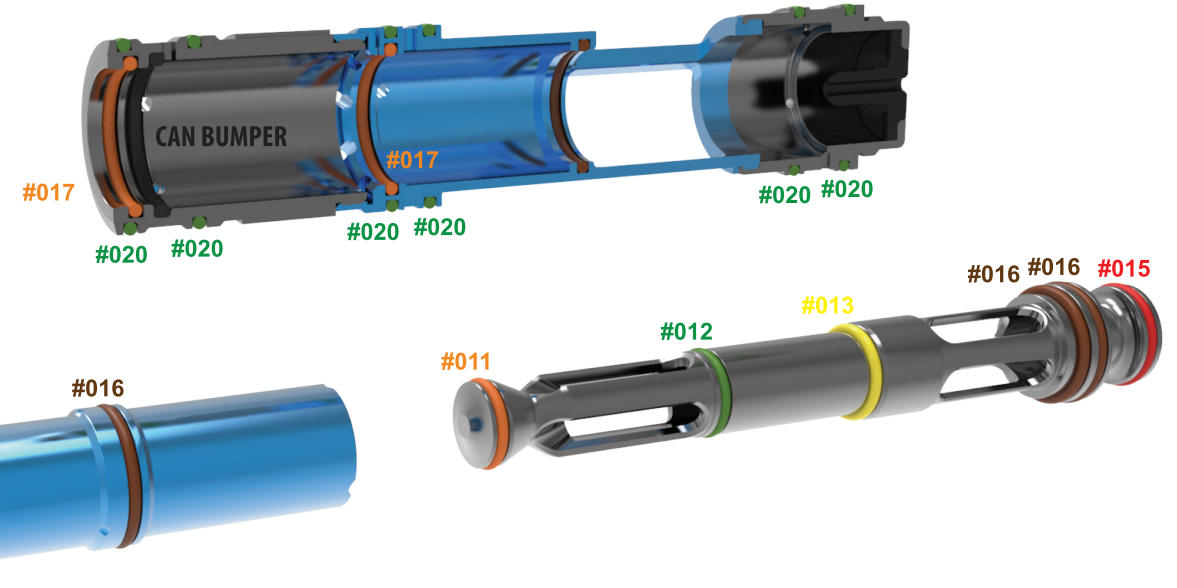

FL-21™ ENGINE O-RING LIST (COLOR CODED)

- #011 - BN70 Valve tip o-ring
- #012 - BN70 Valve guide o-ring
- #013 - BN70 Rear bumper
- #014 - BN70 Bolt tip o-ring
- #015 - BN70 Valve core rear o-ring
- #016 - BN70 Bolt sail, rear top hat , valve core front o-rings
- #017 - BN70 Cylinder, front top hat o-rings
- #020 - BN70 Outer sleeve o-rings





HYPER6S PRO™ GAS THRU REGULATOR

BASIC VELOCITY ADJUSTMENT

ADJUSTMENTS

The Hyper6s regulator controls your velocity.

It is pre-set at approximately 115 psi. This will enable your gun to shoot about 285 FPS. The M3s's velocity will be affected by paint size, weather conditions, altitude and other factors. To adjust your velocity use a 3/16" Allen wrench and insert it into the bottom of the fore grip where the Hyper6s reg is located.

To lower the velocity turn the Allen wrench clockwise (inward), this will decrease the pressure.

To raise the velocity turn the Allen wrench counter clockwise (outward) this will increase the pressure.

Each 1/3 turn will change the Hyper6s reg output Pressure by approximately 15PSI.

The M3s is equipped with an internal pressure sensor for the Hyper6s. You are able to view your Hyper6s reg pressure at any time on the OLED screen. The Pressure readings can be viewed by entering into the Data Settings Menu and scrolling to the Pressure Gauge Screen (see page 7), or while in the Playing Screen you can press the joystick left and the Systems Check screen will appear for 10 seconds and display your M3s's PSI reading, along with other information about the M3s's operating system (see page 4).

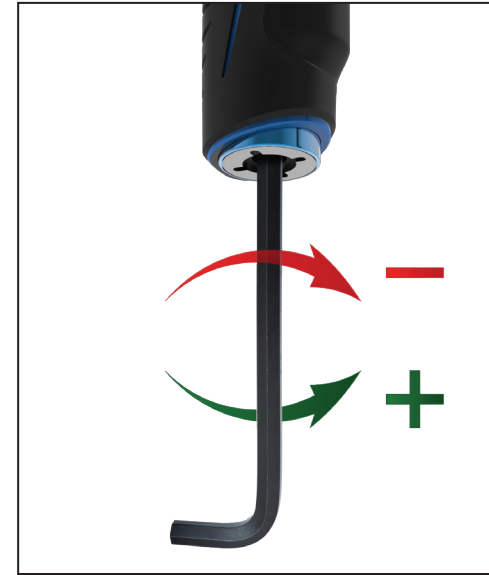

HYPER6S PRO COMPONENT LIST

- | | |
|------------------------------|---------------------------|
| 1. 007 UR90 o-ring | 9. Cartridge body |
| 2. 014 BN70 o-ring | 10. 008UR90 o-ring |
| 3. Reg body | 11. Seat retainer |
| 4. Attachment screw | 12. Purging reg seat |
| 5. Piston | 13. Check valve |
| 6. Main spring | 14. Check valve spring |
| 7. 015BN70 o-ring (3 pieces) | 15. Adjustment screw |
| 8. Cartridge top cap | 16. 010BN70 o-ring |
| | 17. Rubber retaining ring |

! WARNING

- THE HYPER6S™ CAN HOLD A SMALL RESIDUAL CHARGE OF GAS, TYPICALLY 1 SHOT. ALWAYS DISCHARGE THE MARKER IN A SAFE DIRECTION TO RELIEVE THIS RESIDUAL GAS PRESSURE.
- EXCESSIVE DIRT AND DEBRIS CAN AFFECT THE HYPER6S™'S PERFORMANCE AND INCREASE THE NEED FOR SERVICE.

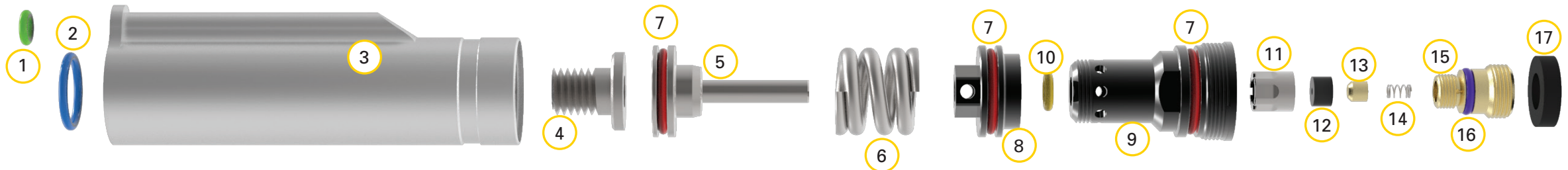

The M3s software tracks how many shots the marker has fired, and will alert you when service is due. A red service icon will flash over the playing screen. See service system on page 9 for more info.

NOTE: IT IS IMPORTANT TO KEEP THE SEAT AND PISTON FACE CLEAN OF ALL DIRT AND DEBRIS. CLEAN THE SEAT AND PISTON FACE AND APPLY FRESH GREASE EVERY 6 MONTHS OR 75,000 - 100,000 SHOTS, DEPENDING ON PLAYING CONDITIONS.

HYPER6S PRO™ REGULATOR DISASSEMBLY INSTRUCTIONS

The Hyper6s™ assembly is housed in a self-contained cartridge. A fouled Hyper6s™ cartridge can be quickly removed for service. In most cases the only seal that needs to be serviced is the regulator seat, located in the seat retainer. The rubber sleeve on the outside of the Hyper6s™ does not need to be removed to disassemble the Hyper6s™.

- Using the rounded top edge of the hex wrench on your Dye multi-tool, or a coin
Unscrew and remove the Hyper6s™ assembly cartridge from the bottom of the Hyper6s™ fore grip housing.
- The Hyper6s™ piston and spring may or may not come out with the cartridge. If the piston and shim stack remain in the housing, use a pair of needle nose pliers to gently pull the piston out.

CHANGING THE HYPER6S PRO™ REG SEAT

- Use a straight pick to remove the black rubber retaining ring.
 - Use a 3/16" Allen wrench, to unscrew and remove the brass Hyper6s™ seat retainer assembly.
 - Use a small pair of pliers to unscrew the cap of the seat retainer assembly.
- NOTE: BE CAREFUL NOT TO LOSE THE PURGE POPPET AND/OR SPRING.
- From the top of the cap, use a 3/16" Allen to press the seat out of the cap.
 - Press a new reg seat into the cap from the bottom.
 - Lube the 010 O-ring, and screw the seat retainer assembly back into the cartridge.
 - Install the black rubber retaining ring.

HYPER6S™ ASSEMBLY AND INSTALLATION

- Insert the piston through the large regulator spring.
- Apply Grease to the 015 Red Piston O-rings and bottom 3/8" of the piston shaft.
- Insert the piston shaft into the top of the Hyper6S™ cartridge.
- Make sure the spring sits evenly around the hex head.
- Be sure to grease the two 015 Red O-rings on the outside of the Hyper6s™ cartridge. Take care when inserting the cartridge, not to cut or pinch outer O-rings on the cross holes and threads in the Hyper6s™ fore grip housing.
- Install the assembled cartridge into the Hyper6s™ fore grip housing using the rounded top edge of the hex wrench on your Dye multi-tool, or a coin.

HYPER6S PRO™ GAS THRU REGULATOR

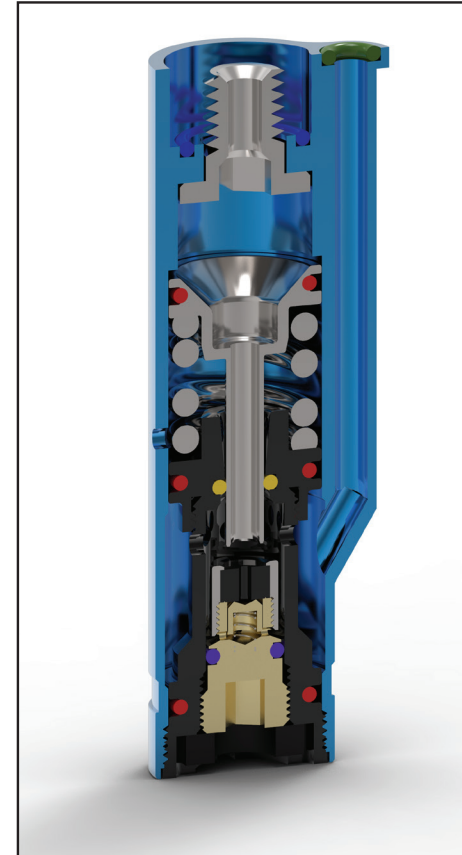

! WARNING

- **THE HYPER6S™ CAN HOLD A SMALL RESIDUAL CHARGE OF GAS. ALWAYS DISCHARGE THE MARKER IN A SAFE DIRECTION TO RELIEVE THIS RESIDUAL GAS PRESSURE.**
- **EXCESSIVE DIRT AND DEBRIS CAN AFFECT THE HYPER6S™'S PERFORMANCE AND INCREASE THE NEED FOR SERVICE.**

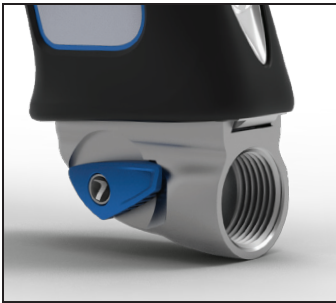

SHIFTPORT ASA

The M3s comes equipped with the ShiftPort ASA attached to the bottom of the frame. To turn on the gas supply, rotate the side lever counter clockwise until the internal stop is reached. To turn off the gas supply, rotate the side lever clockwise until the other stop is reached. As you rotate the side lever past the mid point, the gas stored in the marker will vent.

SHIFTPORT ASA LENGTH ADJUSTMENT

The ShiftPort can be adjusted for optimal comfort. There is a horizontal locking screw located on the bottom right side of the Ultralite frame. It can be accessed with a 1/8" Allen wrench through a hole in the grip panel. To unlock the ShiftPort ASA for adjustment turn the locking screw counterclockwise one full turn. Slide the airport back or forth to the desired location. To lock the airport in place turn the locking screw clockwise until the airport is firmly secured in place. The ShiftPort ASA has a forward and rearward travel stop. Do not remove these stops or move the airport past its intended range of travel.

REMOVE PIN-HOUSING ASSEMBLY

To disassemble the ShiftPort ASA use the airport tool included on the DYE Multi-Tool. However, a pair of needle-nose pliers can be used to unscrew the Pin Housing. Just take care to not scratch or damage the threads or Pin Housing.

- Insert the airport tool into the Pin Housing and turn counterclockwise 3-4 revolutions. Note that the airport lever must be in the OFF position for the tool to grab the housing. Remove housing out of the airport body.
- The pin and **006 O-ring** may or may not come out with the housing, if necessary use a pair of needle-nosed pliers to pull the pin out and a dental pick to remove the **006 O-ring**.

INSTALL PIN HOUSING ASSEMBLY

- Coat the **006 O-ring** in lube and drop it into the airport body. Use the tip of a 1/4" Allen wrench to fully seat the O-ring in place by pushing gently on it.
- Insert the Pin into the Pin Housing from the backside.
- Place the housing onto the airport tool and insert the housing into the airport body.
- Turn clockwise until the Pin Housing fits snugly into the airport body.

NOTE: IF THE AIRPORT TOOL IS NOT AVAILABLE, A PAIR OF NEEDLE-NOSE

PLIERS CAN BE USED TO UNSCREW THE PIN HOUSING. JUST TAKE CARE TO NOT SCRATCH OR DAMAGE THE THREADS OR PIN HOUSING.

REMOVE THE AIRPORT LEVER AND INTERNAL CAM

- Remove the DYE sphere jewel located in the middle of the airport lever.
- Use a 3/32" Allen wrench to unscrew the retaining screw and remove the screw and lever.
- Insert a dental pick into the small slot to pull out the **010 retaining O-ring**. If the Pin and Pin housing have been removed, the cam should come out with no resistance. If the Pin and Pin Housing are installed in the airport body, the cam must be in the ON position so it can be removed.

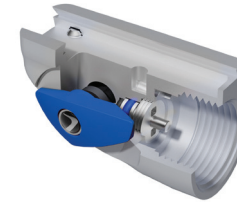

INSTALL AIRPORT LEVER AND CAM

- Make sure that the Pin is not protruding into the area where the Cam sits.
- Use a dental pick or small Allen wrench to push the pin out of the bore if necessary.
- Drop the Cam into the airport body such that the slot faces upwards and rotate it clockwise until it drops in place and hits the internal stop.
- Insert the **010 retaining O-ring** into the groove and gently work it in place with a dental pick or small screwdriver.
- Push the Lever into the Cam slot so that the Lever is facing down, or in the OFF position.
- Install the retaining screw with a 3/32" Allen wrench and tighten firmly. Turn the Lever counter-clockwise until it hits the internal stop. Replace the jewel on the Retaining Screw so that the Dye sphere is correctly oriented.

NOTE: FOR EXPLODED VIEW OF AIRPORT SEE PAGE 27.

WARNING

EVEN WITH THE AIR SUPPLY REMOVED THE MARKER MAY HAVE GAS INSIDE. BE SURE TO VENT THIS GAS. MAKE SURE THERE ARE NO PAINTBALLS IN THE BREECH AND DRY FIRE THE MARKER IN A SAFE DIRECTION.

ULTRALITE FRAME & LOCKDWN2 CLAMPING FEED NECK

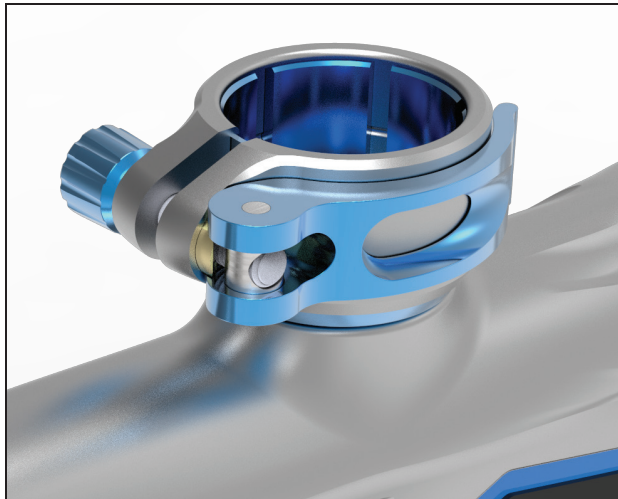

LOCKDWN2 CLAMPING FEED NECK

The Lockdwn2 clamping Feedneck is adjustable to fit any standard loader. To adjust the cam locking system, lift the cam lever away from the feed collar, and rotate the adjustment knob clockwise to tighten or counterclockwise to loosen the grip on the loader. Once the desired adjustment is made, press the cam lever down against the feed collar to secure the loader in the feedneck. To loosen the locking system and remove the loader, lift the cam lever away from the feed collar. Take care not to over-tighten the cam locking system. The lever should not be

overly difficult to lower into the locked position.

REMOVING ULTRALITE FRAME FROM THE M3S

- If there is ever need to remove the Ultralite frame from the M3s make sure to follow these steps.
- Remove the UL Sticky grips from the frame to expose the rear mounting screw
- Remove the front reg sleeve to expose the front mounting screw
- Using a 3/32" Allen wrench, remove back frame screw
- Unscrew front frame screw until the frame can drop free of the M3s body
- The M3s utilizes a positive force contact pad to link the body and frame electrical components together (There are no wires to disconnect when removing the frame from the Body)

NOTE: BE SURE THAT THE FRAME AND TRIGGER ASSEMBLY ARE KEPT CLEAN. IF THERE IS EXCESS DIRT OR PAINT BUILD UP AROUND THE TRIGGER, THE TRIGGER WILL NO LONGER MOVE FREELY. IN ADDITION, PAINT AND DIRT CAN CAUSE THE MICRO SWITCH TO NOT FUNCTION PROPERLY OR FAIL.



ANTI CHOP EYES

The Anti Chop Eye (ACE) system will help prevent the M3s from chopping paint by preventing the marker from firing until a ball is fully seated in front of the bolt. The eyes use a light beam across the breech. In order for the marker to fire with the eyes turned on, the signal between the two eyes must be broken (a paintball in the breech). After every shot, before the next ball drops in the breech, the eye transmitter and receiver must see each other. If there is a malfunction, the LED's on the board will start blinking green. This means that the eyes do not see each other. If this is the case, there are normally two reasons. Either there is dirt, paint or grease blocking the beam, or the battery is so low there is not enough power to create a strong enough light beam.

Turning anti chops eyes off or on: The eye system is automatically powered on during boot up.

To turn the eyes on or off, press and hold the joystick down for 2 seconds. The LED light will begin flashing red when eyes are off.

To turn the eyes back on, press and hold the joystick down for 2 seconds until the LED turns either red or green.

LED LIGHT COLOR INDEX

Red: Breech is clear, no ball (eyes on)

Green: Ball in breech, ready to fire (eyes on)

Blinking Red: Eyes are off

Blinking Green: Eye failure

NOTE: IF THE BATTERY IS LOW, THE MARKER MAY ACT AS IF THE EYES ARE DIRTY OR NOT FIRE AT ALL. IN THIS CASE, CHARGE BATTERY.

SELF CLEANING EYE PIPE

The M3s is equipped with a patented self-cleaning eye pipe feature. There is a clear polycarbonate sleeve mounted inside the breech of the gun covering the eyes. When the bolt tip O-ring passes through the eye pipe, it sweeps off any dirt, grease or paint that could be blocking the eyes. Normally it is enough to just fire the M3s to clean anything blocking the eyes. If this does not clear the blockage use a swab to clean the inside of the breech.

For a more thorough cleaning, pull the eye pipe with the ball detents out the front of the breech. With the eye pipe out use a swab to clean the breech. This should be enough to clean the eye system.

EYE PIPE ANTI CHOP EYES/ BALL DETENTS

CHANGING BALL DETENTS

The ball detent system is clipped to the outside of the eye pipe. The ball detent system needs little or no maintenance. The detents should easily flex out of the way with little force, such as a paintball moving past. If you are experiencing double feeding or chopping, check the condition of your ball detents with your finger to make sure they are not broken, stuck in the up or down position, and that they move in and out of the breech freely. If excessive broken paint or dirt has jammed your ball detents, remove the eye pipe/detent system from the front of the M3s and unclip the detents for a thorough cleaning. Reinstall the detents, and eye pipe after you have sufficiently cleaned the detents and breech.



Be careful not to over-flex the detents when handling them. Excessive flexing could break or damage the detents.

NOTE: TAKE CARE WHEN REPLACING THE EYE PIPE. BE CAREFUL THAT THE DETENT CLIP IS FULLY SEATED ONTO THE EYE PIPE.

AIR LEAKS

AIR LEAKING FROM THE BACK OF AIRPORT

- Check the O-ring on the air system. If needed change the O-ring and try again. The O-ring normally used is 015 but some manufacturers might use a different size. Consult the manual of the air system you are using.

AIR LEAKING BETWEEN FRAME & AIRPORT

- Make sure airport locking screw is tight Air leaking from the Hyper6s™ regulator
- First locate the position of the leak.
- For disassembly instructions consult the technical section under Hyper6s™ regulator (see page 18).
- If the leak is coming from the bottom of the regulator you will need to disassemble the regulator and change the 010 O-ring and the seat on the brass seat retainer mounted inside the Hyper6s™ regulator.
- If the leak comes from the small hole in the middle of the regulator there are three possible O-rings causing the problem, the 015 O-ring on the piston, the 008 yellow O-ring inside the regulator cartridge, and the upper 015 red o-ring on the Regulator cartridge.
- If the leak is from the top of the regulator, the leak should be repaired by a trained Tech.

AIR LEAKING FROM THE HYPER6S™ REGULATOR

- First locate the position of the leak.
- For disassembly instructions consult the technical section under Hyper6s™ regulator (see page 18).
- If the leak is coming from the bottom of the regulator you will need to disassemble the regulator and change the 010 O-ring and the seat on the brass seat retainer mounted inside the Hyper6s™ regulator.
- If the leak comes from the small hole in the middle of the regulator there are three possible O-rings causing the problem, the 015 O-ring on the piston, the 008 yellow O-ring inside the regulator cartridge, and the upper 015 red o-ring on the Regulator cartridge.
- If the leak is from the top of the regulator, the leak should be repaired by a trained Tech.

AIR LEAKING BETWEEN BODY AND FRAME

- First pull out the Bolt kit and change the #016 sail O-ring, the rear 020 O-ring on the outside of the cylinder, and the 020 O-ring on the outside of the top hat.
- If leak is coming from the blocked hole on the right when looking at the marker from the front, remove the screw, apply some thread sealant and re-attach screw to the body.
- If leak is from hole on left side, remove the vertical set screw and use a set of needle nose pliers to gently pull the air transfer tube from the body. Replace the front 1.5mm x 2.5mm O-ring. Lube the 3 O-rings and insert it back into the body and tighten the retaining set screw.
- If the solenoid is leaking, remove the solenoid by unscrewing the two screws mounting it down. Apply some lube to the gasket underneath the solenoid and reassemble making sure that the solenoid is well tightened into the body.
- Hyper6s™ may be supplying too low of air pressure. Make sure the Hyper6s™ is set correctly.(see page 18).
- Any miss alignment between the frame and body will result in the HP air passage union seal to leak. Inspect the condition of the 013-BN90 green seal. Make sure the frame mounting screws are securely tightened.

AIR LEAKING FROM BACK OF THE M3S

- Check that the bolt kit is fully locked into the M3s. If the bolt kit is loose tighten lock pin.
- If above does not solve the leak, remove the bolt kit and change the 020 O-ring on the back cap. Also change the two 011 O-rings located in the stem of the bolt. Lube well and re-insert the bolt kit into the M3s. Check bolt kit break down picture on page 15 for O-ring locations.

AIR LEAKING FROM FRONT OF THE M3S

- Check that the bolt kit is fully locked into the M3s.
- If above does not solve the leak, remove the bolt kit and

change the 020 O-ring on the back cap. Also change the 015 O-ring located on the rear of the valve. Lube well and re-insert the bolt kit into the M3s. Check bolt kit break down picture on page 15 for O-ring locations.

AIR LEAKING FROM ON/OFF KNOB OR BLEED HOLE

- Make sure airport is in full on or off position.
- Check 006 O-ring behind pin housing.
- See page 20 for service details.

OTHER CATEGORIES

DOUBLE FEEDING

- If more than one ball is feeding at a time into the breech of your M3s, check to see if the ball detents are stuck behind the eye pipe. To make sure your ball detents and eye pipe are properly assembled see pages 22.
- Make sure the ball detents are not excessively worn.

BREAKING PAINT

- Make sure you use high quality paintballs and that they are stored according to the manufacturer's instructions.
- Check that 014 O-ring on bolt tip is in place and in good condition.
- Make sure your loader is working properly and that the rate of fire is not set higher than the maximum feed rate of the loader.
- Check that the barrel you are using is not too tight for the paintballs you are using.
- Make sure the ball detent system is working properly. (see pages 22).
- Be sure the Hyper6s™ is not set too high (see pages page 8, 18, and 19).

PROBLEMS WITH ELECTRONICS

M3S WON'T TURN ON

- Make sure battery is well charged. Marker shooting slow when eye is on and blinking green
- The eyes are not working correctly. Clean the eyes. You'll know that they are clean if the LED turns red when there is nothing inside the breech of the M3s.
- Make sure the eye wires are not broken or pinched.
- The battery may be low. In this case, the battery should be charged as soon as possible.

MARKER SHOOTING SLOW WHEN EYE IS ON AND BLINKING GREEN

- The eyes are not working correctly. Clean the eyes. You'll know that they are clean if the LED turns red when there is nothing inside the breech of the M3s.
- Make sure the eye wires are not broken or pinched.
- The battery may be low. In this case, the battery should be charged as soon as possible.

SOLENOID WILL NOT ACTIVATE / TRIGGER NOT WORKING

- Check that the trigger adjustment is not set so that the micro switch cannot activate. You should hear a small click when pulling the trigger.
- If the M3s fires once when turned on but not after that, your trigger is set so that the micro switch is always activated. Re-adjust the trigger.
- Check that the solenoid cable is attached to the board and to the correct connector (solenoid should be attached to the two-prong connector).
- Check the Dwell is set correctly (see page 5).

TRIGGER BOUNCE / M3S SHOOTING MORE THAN ONE BALL PER PULL IN SEMI-AUTOMATIC MODE

- Raise the trigger sensitivity level in the configuration mode.
- Check that the trigger is not adjusted too short.

ERRATIC VELOCITY / M3S WON'T FIRE

M3S FIRES BUT BALLS ARE DROPPING OFF OR NOT EVEN COMING OUT OF THE BARREL

- Make sure the battery is charged.
- Maintain the factory dwell setting of 16.
- Make sure bolt is well lubed and moves well. If there is too much friction in the bolt it will cause the M3s to shoot down. Replace O-rings causing this excess friction.
- Make sure air system is screwed in all the way.
- Make sure Hyper6s™ is set correctly.

FIRST SHOT IS TOO HIGH

- Change the seat inside the Hyper6s™ Regulator. For disassembly instructions consult page 18 in the technical section.
- Check that the 011 and 012 O-rings on the valve tube, as well as the 016 on the inside of the top hat are in good condition.
- Try turning off the ABS feature.

VELOCITY IS NOT CONSISTENT

- Make sure the paintballs you are using fit the barrel well and are consistent in size and shape.
- Remove the bolt kit and re-lube it. Change any O-rings causing a lot of friction. Make sure 014 O-ring in bolt tip is in place and in good condition.
- Ensure the spring behind the valve is in place and that the 016 O-ring at the back of the valve tube is in place and in good condition.
- Check that the Hyper6s™ regulator is working correctly and that the pressure is consistent.
- Disassemble and change worn out O-rings and the regulator seat in the Hyper6s™ regulator.

BOOST SCREEN



PLAY MODE SCREEN



SYSTEMS CHECK



POWER OFF SCREEN



PROFILE SELECTION



SETTING ADJUSTMENT

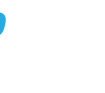
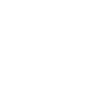
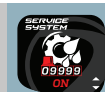
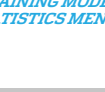
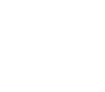
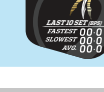
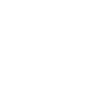
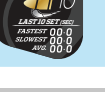
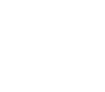
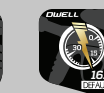
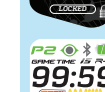
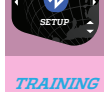

FACTORY DEFAULT

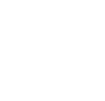

TRAINING MODE



MBS MOSAIR MENU MAP

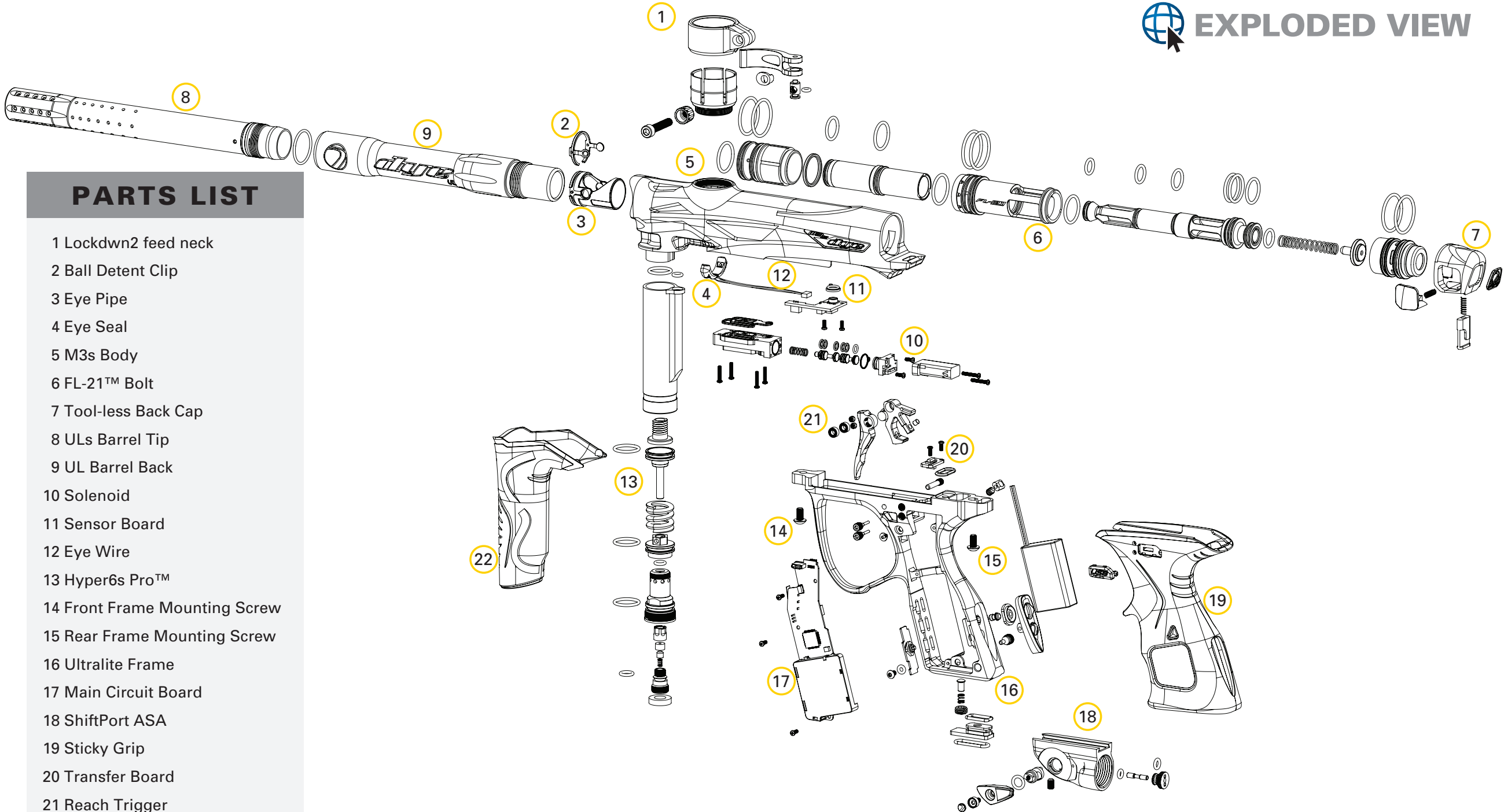

PARTS LIST

- 1 Lockdwn2 feed neck
- 2 Ball Detent Clip
- 3 Eye Pipe
- 4 Eye Seal
- 5 M3s Body
- 6 FL-21™ Bolt
- 7 Tool-less Back Cap
- 8 ULs Barrel Tip
- 9 UL Barrel Back
- 10 Solenoid
- 11 Sensor Board
- 12 Eye Wire
- 13 Hyper6s Pro™
- 14 Front Frame Mounting Screw
- 15 Rear Frame Mounting Screw
- 16 Ultralite Frame
- 17 Main Circuit Board
- 18 ShiftPort ASA
- 19 Sticky Grip
- 20 Transfer Board
- 21 Reach Trigger
- 22 Front Grip Sleeve

M3S WARRANTY AND LEGAL INFORMATION

WARRANTY

DYE Precision, Inc. warrants for one year to the initial retail purchaser, from the initial date of purchase, that the paintball marker and regulator are free from defects in materials and workmanship, subject to the requirements, disclaimers and limitations of this warranty. Disposable parts, normal maintenance and standard wear and tear parts such as batteries, O-rings and seals are not warrantied. The solenoid and electronic components on the marker are warrantied for six months. This warranty does not cover scratches, nicks, improper disassembly, improper re-assembly, misuse, neglect or improper storage. Modification to the product will void the warranty. The only authorized lubricant for the marker is UL Slick Lube™. Use of any other lubricant will void your warranty. This warranty is limited to repair or replacement of defective parts with the customer to pay shipping costs. Warranty card and proof of purchase must be submitted to DYE Precision for warranty to be in effect. This warranty is not transferable. This warranty does not cover performance. Paintball markers are non-refundable.

TECHNICAL SUPPORT

Our Technical Support Departments are open Monday through Friday.

DYE Precision, Inc. can be reached at 858-536-5183 ext.276 from 8am to 5pm PST.

DYE Europe can be reached at +44 (0) 20-8649-6330 from 9am to 5pm GMT.

DYE Asia can be reached at 886 (0) 4-2407-9135 from 9am to 5pm GMT +8 hours.

Additional support and international contacts are available through our web site,

www.dyepaintball.com

DISCLAIMER

The specifications & photographs in this material are for information and general guidance purposes only. Our products are continually updated and changes may be made to specification, design or appearance from time to time. These are subject to change without notice. Contents of box may therefore vary from owner's manual. For details of changes in design, specification or appearance consult your local distributor or dealer. The FL-21™ BOLT, FL-21 Legacy™, Hyper6S Pro™ and Slick Lube™ are registered trademarks. Design rights, copyrights and all other rights reserved. All patterns, drawings, photographs, instructions or manuals remain the intellectual property of the manufacturer.

M3S and M3S FL-21 Bolt:

DYE Precision Inc. U.S. and Int'l PATENTS PENDING

U.S. PATENT # 5,613,483; 5,881,707; 6,474,326; 7,765,998; 7,997,260

CONTACT:

DYE Precision, Inc.
10637 Scripps Summit Ct.
San Diego, CA. 92131
P. 858-536-5183
F. 858-536-5191

DYE Germany GmbH
Albert Einstein Str. 2 B
77656 Offenburg
Germany
P. +4 (0)781 639 349 91

DYE Asia
No. 253, Guojhong Rd.
Dali Dist., Taichung City 412
Taiwan (R.O.C.)
P. +886 (0) 4-2407-9135
F. +886 (0) 4-2407-2090

