

**BOLT**<sup>®</sup>  
BREAKTHROUGH ONE-KEY LOCK TECHNOLOGY

Unlock **YOUR** World

with  
the

**CONVENIENCE** of  
**ONE Key!**















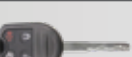



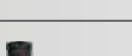

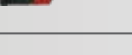
**BOLTLOCK.com**



**2016**

**VEHICLE APPLICATIONS**

	<b>CHRYSLER</b>	<b>P - 3</b>
	<b>GM EARLY</b>	<b>P - 4</b>
	<b>GM LATE</b>	<b>P - 5</b>
	<b>GM CENTER CUT</b>	<b>P - 6</b>
	<b>FORD</b>	<b>P - 6 &amp; 7</b>
	<b>FORD SIDE CUT</b>	<b>P - 7</b>
	<b>TOYOTA</b>	<b>P - 8</b>
	<b>NISSAN</b>	<b>P - 8</b>
	<b>PADLOCK</b>	<b>P - 9</b>
	<b>CABLE LOCK</b>	<b>P - 9</b>
	<b>5/8" RECEIVER LOCK</b>	<b>P - 10</b>
	<b>1/2" RECEIVER LOCK</b>	<b>P - 10</b>
	<b>COUPLER PIN LOCK</b>	<b>P - 11</b>
	<b>TOOLBOX LATCH RETRO FIT KIT</b>	<b>P - 12</b>
	<b>BOLT CYLINDER</b>	<b>P - 12</b>
	<b>BOLT CYLINDER NUT</b>	<b>P - 12</b>
	<b>GM TAILGATE HANDLE</b>	<b>P - 13</b>
	<b>JEEP SPARE TIRE LOCK</b>	<b>P - 13</b>
	<b>JK HOOD LOCK</b>	<b>P - 14</b>
	<b>J-Mount</b>	<b>P - 15</b>

# CHRYSLER VEHICLE APPLICATIONS

MAKE	MODEL	YEAR	MAKE	MODEL	YEAR
<b>CHRYSLER</b>	200	2012 - 2014	<b>DODGE</b>	Avenger	2007 - 2014
	300 (All)	1999 - 2016		Caliber	2006 - 2012
	Aspen	2007 - 2009		Caravan, Grand Caravan	1991 - 2016
	Cirrus	1995 - 2005		Challenger	2009 - 2016
	Concorde	1993 - 2003		Charger	2005 - 2016
	LHS	1994 - 2003		Dakota	1990 - 2012
	Pacifica	2004 - 2008		Dart	1990 - 2016
	Prowler	1997 - 2002		Durango	1998 - 2016
	PT Cruiser	2001 - 2011		Dynasty	1990 - 1993
	Sebring	1996 - 2011		Intrepid	1993 - 2004
	Town and Country Van	1991 - 2016		Journey	2009 - 2016
	Voyager	2001 - 2004		Magnum	2005 - 2008
<b>JEEP</b>	Cherokee	1991 - 2016	Neon	1994 - 2006	
	Comanche	1991 - 1993	Nitro	2007 - 2011	
	Commander	2005 - 2010	Stratus	1995 - 2005	
	Compass	2007 - 2016	Viper Coupe	1998 - 2000	
	Grand Cherokee	1992 - 2016	Viper	1993 - 2013	
	Liberty	2002 - 2014	International	2006 - 2015	
	Patriot	2007 - 2016	Mitsubishi Raider	2006 - 2009	
<b>RAM</b>	Wrangler	1991 - 2016	Sterling	1990 - 2013	
	Ram Charger	1990 - 1993	Volvo VN Series	2005 - 2013	
	Ram Pickup, Chassis	1990 - 2016	Freightliner	1997 - 2015	
	Ram Van	1990 - 2005			
	Ram CV Tradesman	2012 - 2015			

Part Number	BOLT Product
7019344	1/2" Receiver
7018448	5/8" Receiver
7018452	Cable Lock
7025286	Coupler Pin Lock
7028648	J-Mount - Driver Side, Black (1997+)
7028649	J-Mount - Passenger Side, Black (1997+)
7028650	J-Mount - Driver Side, Black (1997+)
7028651	J-Mount - Passenger Side, Black (1997+)
5922986	Jeep Spare Tire Lock (1997 +)
7026128	JK Hood Lock (2007 +)
692916	Lock Cylinder
7018520	Padlock
7022699	Toolbox Latch



MAKE	MODEL	YEAR	MAKE	MODEL	YEAR
<b>BUICK</b>	Century	1998 - 2005	<b>CHEVROLET</b>	Astro	1996 - 2005
	LeSabre	2000 - 2005		Avalanche	2002 - 2006
	Park Avenue	1997 - 2005		Cavalier	1995 - 2005
	Ranier	2004 - 2007		Corvette	1998 - 2004
	Regal	1998 - 2004		Express Van	1996 - 2007
	Rendezvous	2001 - 2007		Impala	2000 - 2005
	Riviera	1995 - 1999		Kodiak	2003 - 2005
	Skylark	1994 - 1999		Malibu	1997 - 2004
	Terraza	2005 - 2007		Monte Carlo	2000 - 2005
<b>CADILLAC</b>	CTS	2003 - 2007		S10 Blazer & Pickup	1995 - 2005
	Deville	2000 - 2005		SSR	2005 - 2006
	Escalade	1999 - 2005		Silverado	1995 - 2006
	Seville	1997 - 2004		Suburban	1995 - 2006
	STS	2004 - 2007		Tahoe	1995 - 2006
	XLR	2006		Trailblazer	2002 - 2009
<b>OLDSMOBILE</b>	Achieva	1994 - 1999		Uplander	2005 - 2009
	Alero	1999 - 2004	Venture Van	1999 - 2005	
	Aurora	1995 - 2003	Envoy	2002 - 2009	
	Bravada	1996 - 2005	Jimmy	1995 - 2005	
	Cutlass	1997 - 1999	Safari	1995 - 2005	
	Intrigue	1998 - 2002	Savana Van	1996 - 2007	
<b>PONTIAC</b>	Silhouette	1997 - 2004	<b>GMC</b>	Sierra	1995 - 2006
	Aztek	2001 - 2006		Sonoma	1995 - 2005
	Bonneville	2000 - 2005		Top Kick	2003 - 2005
	Grand Am	1994 - 2006		Yukon	1995 - 2006
	Grand Prix	1997 - 2003		H2	2003 - 2007
	Montana	1999 - 2006		Isuzu Ascender	2003 - 2007
	Sunfire	1995 - 2005	Isuzu Hombre	1996 - 2000	
	SV6	2007 - 2008	Saturn Relay	2005 - 2007	
Transport	1997 - 1998	<b>HUMMER</b>	<b>OTHER</b>		

Part Number	BOLT Product
7019341	1/2" Receiver
7018445	5/8" Receiver
7018449	Cable Lock
7025283	Coupler Pin Lock
692918	Lock Cylinder
7018517	Padlock
7022696	Toolbox Latch



# GM LATE VEHICLE APPLICATIONS

MAKE	MODEL	YEAR	MAKE	MODEL	YEAR
<b>BUICK</b>	Allure	2005	<b>CHEVROLET</b>	Avalanche	2007 - 2013
	Enclave	2007 - 2016		Cobalt	2005 - 2010
	Lacrosse	2005 - 2009		Corvette	2005 - 2013
	Lucerne	2005 - 2011		Equinox	2007 - 2009
<b>CADILLAC</b>	CTS	2008 - 2013		Express Van	2008 - 2014
	DTS	2005 - 2011		HHR	2006 - 2011
	Escalade	2006 - 2014		Impala	2006 - 2013
	SRX	2005 - 2013		Malibu	2005 - 2013
<b>PONTIAC</b>	G5	2007 - 2010		Monte Carlo	2006 - 2009
	G6	2005 - 2010		Silverado	2007 - 2013
	Grand Prix	2006 - 2008	Silverado HD	2007 - 2014	
	Pursuit	2006 - 2010	Suburban	2006 - 2014	
	Solstice	2006 - 2010	Tahoe	2006 - 2014	
	Torrent	2007 - 2010	Traverse	2009 - 2015	
<b>SATURN</b>	Aura	2007 - 2010	<b>GMC</b>	Acadia	2007 - 2016
	Ion	2003 - 2007		Savana Van	2008 - 2014
	Outlook	2007 - 2010		Sierra	2007 - 2013
	Sky	2007 - 2010		Sierra HD	2007 - 2014
	Vue	2007		Yukon	2006 - 2014
			<b>HUMMER</b>	H2	2008 - 2009

Part Number	BOLT Product
7019342	1/2" Receiver
7018446	5/8" Receiver
7018450	Cable Lock
7025284	Coupler Pin Lock
692915	Lock Cylinder
7018518	Padlock
5922987	GM Tailgate Handle <i>(Includes Lock Cylinder)</i>
709231	Tailgate Lock Cylinder
7022697	Toolbox Latch



# GM CENTER CUT APPLICATIONS

MAKE	MODEL	YEAR
<b>BUICK</b>	Allure	2010 - 2012
	Encore	2014 - 2016
	LaCrosse	2010 - 2016
	Regal	2011 - 2016
	Verano	2012 - 2016
<b>CADILLAC</b>	ATS	2013 - 2016
	CT6	2016 +
	CTS	2014 - 2016
	ELR	2014 - 2016
	Escalade	2015 - 2016
	SRX	2014 - 2016
	XTS	2013 - 2016
<b>GMC</b>	Canyon *	2015 - 2016
	Savana Van	2015 - 2016
	Sierra	2014 - 2016
	Sierra HD	2015 - 2016
	Terrain	2010 - 2016
	Yukon	2015 - 2016



MAKE	MODEL	YEAR
<b>CHEVROLET</b>	Camaro	2010 - 2016
	Colorado*	2015 - 2016
	Corvette	2014 - 2016
	Cruze	2011 - 2016
	Equinox	2010 - 2016
	Express Van	2015
	Impala	2014 - 2016
	Malibu	2014 - 2016
	Silverado	2014 - 2016
	Silverado HD	2015 - 2016
	Sonic	2012 - 2016
	Tahoe	2015 - 2016
	Volt	2011 - 2015



Part Number	BOLT Product
7023627	1/2" Receiver
7023582	5/8" Receiver
7023719	Cable Lock
7025287	Coupler Pin Lock
7023480	Lock Cylinder
7023537	Padlock *
7023547	Toolbox Latch

\*7023537 is not compatible with the Colorado/Canyon key

# FORD VEHICLE APPLICATIONS

MAKE	MODEL	YEAR
<b>FORD</b>	Bronco	1996 - 1999
	Crown Victoria	1996 - 2012
	Econoline Van/Chassis	1996 - 2015
	Edge	2007 - 2015
	Escape	2001 - 2012
	Excursion	2000 - 2006
	Expedition	1997 - 2016
	Explorer	1996 - 2015
	Explorer Sport Trac	2001 - 2011
	Five Hundred	2005 - 2007
	Flex	2009 - 2016
	Focus	2000 - 2011
	Freestar	2004 - 2008

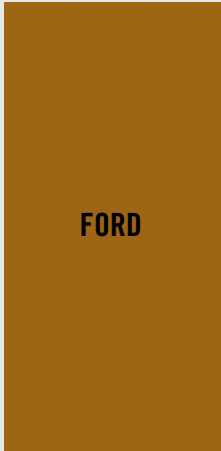

MAKE	MODEL	YEAR
<b>FORD</b>	Freestyle	2004 - 2007
	F-150 Pickup	1996 - 2014
	F-Series Super Duty	1996 - 2016
	Fusion	2005 - 2013
	Mustang	1996 - 2014
	Ranger	1995 - 2012
	Taurus	1997 - 2016
	Taurus X	2008 - 2009
	Thunderbird	1996 - 2006
	Windstar	1998 - 2004
<b>MAZDA</b>	Mazda 626	2002
	Mazda B-Series Pickup	1996 - 2009
	Mazda Tribute	2001 - 2009

# FORD VEHICLE APPLICATIONS

MAKE	MODEL	YEAR	MAKE	MODEL	YEAR
<b>LINCOLN</b>	Aviator	2003 - 2005	<b>MERCURY</b>	Grand Marquis	1998 - 2011
	Blackwood	2002		Marauder	2003 - 2005
	Continental	1996 - 2002		Mariner	2005 - 2011
	LS	2000 - 2006		Milan	2005 - 2011
	Mark LT	2005 - 2014		Montego	2005 - 2007
	Mark VIII	1996 - 1998		Monterey	2004 - 2007
	MKS	2008 - 2016		Mountaineer	1997 - 2011
	MKT	2011 - 2016		Sable	1996 - 2010
	MKX	2006 - 2015		Villager	1996 - 2002
	MKZ	2007 - 2016			
	Navigator	1998 - 2016			
	Town Car	1998 - 2012			

Part Number	BOLT Product
7019343	1/2" Receiver
7018447	5/8" Receiver
7018451	Cable Lock
7025285	Coupler Pin Lock
692917	Lock Cylinder
7018519	Padlock
7022698	Toolbox Latch



# FORD SIDE CUT APPLICATIONS

MAKE	MODEL	YEAR	MAKE	MODEL	YEAR
<b>FORD</b>	C-Max	2015 - 2016	<b>LINCOLN</b>	MKC	2015 - 2016
	Escape	2013 - 2016		MKX	2016 +
	Explorer	2016 +			
	Fiesta	2011 - 2016	<b>LAND ROVER</b>	Evoque	2012 - 2014
	F-150 Pickup	2015 - 2016		LR2	2007 - 2012
	Focus	2011 - 2016		LR3	2005 - 2009
	Fusion	2014 - 2016		LR4	2010 - 2014
	Mustang	2015 - 2016		Range Rover	2007 - 2014
	Transit	2015 - 2016		Range Rover Sport	2007 - 2014
	Transit Connect	2015 - 2016			

Part Number	BOLT Product
7023630	1/2" Receiver
7023585	5/8" Receiver
7023722	Cable Lock
7025290	Coupler Pin Lock
7025636	Lock Cylinder
7023540	Padlock
7023550	Toolbox Latch

\* For proper coding of push button start vehicles, please use your glovebox key to program your BOLT lock.



# TOYOTA VEHICLE APPLICATIONS

MAKE	MODEL	YEAR
<b>TOYOTA</b>	4-Runner	1996 - 2016
	Avalon	1995 - 2012
	Camry	1992 - 2016
	Celica	1994 - 2003
	Corolla	1993 - 2016
	FJ Cruiser	2006 - 2014
	Highlander	2001 - 2015
	Landcruiser	1998 - 2007
	Matrix	2003 - 2014
	Prius	2001 - 2014
RAV-4	1996 - 2015	

MAKE	MODEL	YEAR	
<b>TOYOTA</b>	Sequoia	2001 - 2016	
	Sienna	1998 - 2015	
	Solara	1999 - 2009	
	T100	1993 - 1998	
	Tacoma	1995 - 2016	
	Tundra	2000 - 2016	
	Venza	2009 - 2016	
	Yaris	2007 - 2015	
	<b>SCION</b>	tC	2005 - 2013

Part Number	BOLT Product
7023629	1/2" Receiver
7023584	5/8" Receiver
7023721	Cable Lock
7025289	Coupler Pin Lock
7023482	Lock Cylinder
7023539	Padlock
7023549	Toolbox Latch



*\* BOLT Locks Do Not Support Toyota Center Cut Keys*



# NISSAN VEHICLE APPLICATIONS

MAKE	MODEL	YEAR
<b>NISSAN</b>	350Z	2003 - 2009
	Altima	1999 - 2015
	Armada	2004 - 2015
	Cube	2009 - 2015
	Frontier P/Up	1998 - 2016
	Juke	2011 - 2015
	Maxima	2000 - 2016
	Murano	2003 - 2015

MAKE	MODEL	YEAR
<b>NISSAN</b>	Pathfinder	1996 - 2015
	Quest	2004 - 2015
	Rogue	2008 - 2015
	Sentra	2000 - 2014
	Titan	2004 - 2016
	Versa	2007 - 2016
	X-Terra	2002 - 2015

Part Number	BOLT Product
7023628	1/2" Receiver
7023583	5/8" Receiver
7023720	Cable Lock
7025288	Coupler Pin Lock
7023481	Lock Cylinder
7023538	Padlock
7023548	Toolbox Latch



*\* For proper coding and operation, please use the key that works in your glove box with your BOLT lock.*



## PADLOCK

- 2" Chrome Plated 5/16" Dia. Hardened Steel Shackle
- Weather Proof
- Double Ball Bearing Locking Mechanism
- Plate Tumbler Sidebar to Prevent Picking and Bumping
- Stainless Steel Lock Shutter to Keep Out Dirt and Moisture
- Limited Lifetime Warranty



Part Number	Description
7018520	Padlock Chrysler
7018519	Padlock Ford
7023540	Padlock Ford Side Cut
7018517	Padlock GM Early Model (GM-A)
7018518	Padlock GM Late Model (GM-B)
<sup>1</sup> 7023537	Padlock GM Center Cut *
7023538	Padlock Nissan *
7023539	Padlock Toyota *



<sup>1</sup> 7023537 is not compatible with Colorado/Canyon key

Designed to work with Deeze padlock toolbox

## CABLE LOCK

- 6 ft. Long 1/4in Black Vinyl Coated Coiled Cable
- Weather Proof
- Auto Return Spring Locks Automatically when Key is Removed
- Double Ball Bearing Locking-Mechanism
- Plate Tumbler Sidebar to Prevent Picking and Bumping
- Stainless Steel Lock Shutter to Keep Out Dirt and Moisture
- Limited Lifetime Warranty

Part Number	Description
7018452	6' Cable Lock Chrysler
7018451	6' Cable Lock Ford
7023722	6' Cable Lock Ford Side Cut
7018449	6' Cable Lock GM Early Model (GM-A)
7018450	6' Cable Lock GM Late Model (GM-B)
7023719	6' Cable Lock GM Center Cut
7023720	6' Cable Lock Nissan
7023721	6' Cable Lock Toyota



## RECEIVER LOCK

- Stainless Steel Pin for Durability
- Weather Proof
- Auto Return Spring Locks Automatically when Key is Removed
- Double Ball Bearing Locking-Mechanism
- Plate Tumbler Sidebar to Prevent Picking and Bumping
- Stainless Steel Lock Shutter to Keep Out Dirt and Moisture
- Limited Lifetime Warranty



5/8" PIN FITS 2.5" SQUARE RECEIVERS

Note: All dimensions are in inches

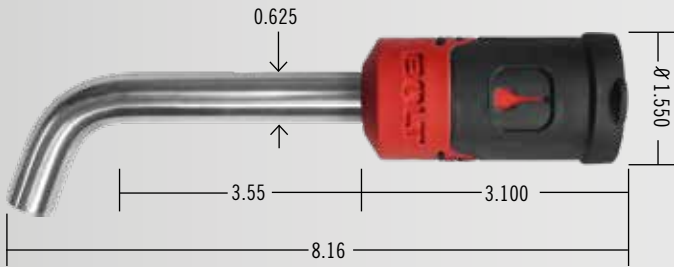

### 5/8" RECEIVER LOCK

Part Number	Description
7018448	5/8" Receiver Lock Chrysler
7018447	5/8" Receiver Lock Ford
7023585	5/8" Receiver Lock Ford Side Cut
7018445	5/8" Receiver Lock GM Early Model (GM-A)
7018446	5/8" Receiver Lock GM Late Model (GM-B)
7023582	5/8" Receiver Lock GM Center Cut
7023583	5/8" Receiver Lock Nissan
7023584	5/8" Receiver Lock Toyota

5/8" Diameter Stainless Steel Pins for Class III, IV & V Receivers

### 1/2" RECEIVER LOCK

Part Number	Description
7019344	1/2" Receiver Lock Chrysler
7019343	1/2" Receiver Lock Ford
7023630	1/2" Receiver Lock Ford Side Cut
7019341	1/2" Receiver Lock GM Early Model (GM-A)
7019342	1/2" Receiver Lock GM Late Model (GM-B)
7023627	1/2" Receiver Lock GM Center Cut
7023628	1/2" Receiver Lock Nissan
7023629	1/2" Receiver Lock Toyota

1/2" Diameter Stainless Steel Pins for Class I + II Receivers (1.5" Square Receiver)



## COUPLER PIN LOCK

- Stainless Steel Pin for Durability
- Fits couplers from 1/2" to 3 3/8" and any size in between
- Lock slides back and forth along pin for ease of use
- 1/8" incremental adjustments allows for snug fit
- Stainless Steel Lock Shutter to Keep Out Dirt and Moisture
- Plate Tumbler Sidebar to Prevent Picking and Bumping
- Weather Proof
- Limited Lifetime Warranty



Part Number	Description
7025286	Coupler Lock Chrysler
7025285	Coupler Lock Ford
7025290	Coupler Lock Ford Side Cut
7025283	Coupler Lock GM Early Model (GM-A)
7025284	Coupler Lock GM Late Model (GM-B)
7025287	Coupler Lock GM Center Cut
7025288	Coupler Lock Nissan
7025289	Coupler Lock Toyota

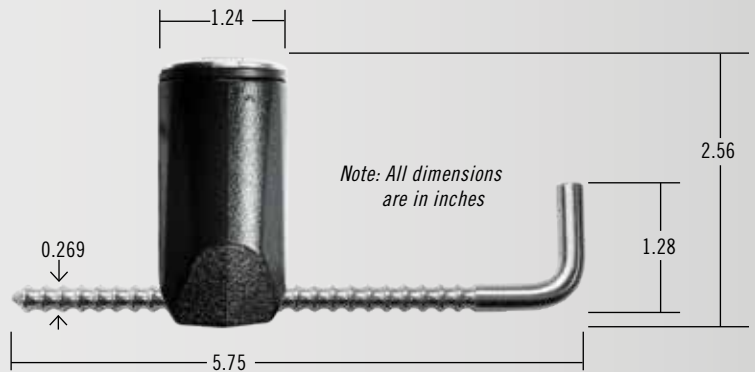

## TOOLBOX LATCH RETRO FIT KIT

- Original Factory Handle with Included BOLT Cylinder
- Weather Proof
- Plate Tumbler Sidebar to Prevent Picking and Bumping
- Stainless Steel Lock Shutter to Keep Out Dirt and Moisture
- Limited Lifetime Warranty



WORKS WITH DEEZEE, UWS AND OTHER LEADING MAKERS OF TOOLBOXES

Part Number	Description
7022699	Toolbox Latch Chrysler
7022698	Toolbox Latch Ford
7023550	Toolbox Latch Ford Side Cut
7022696	Toolbox Latch GM Early Model (GM-A)
7022697	Toolbox Latch GM Late Model (GM-B)
7023547	Toolbox Latch GM Center Cut *
7023548	Toolbox Latch Nissan *
7023549	Toolbox Latch Toyota *

Note: All dimensions are in inches

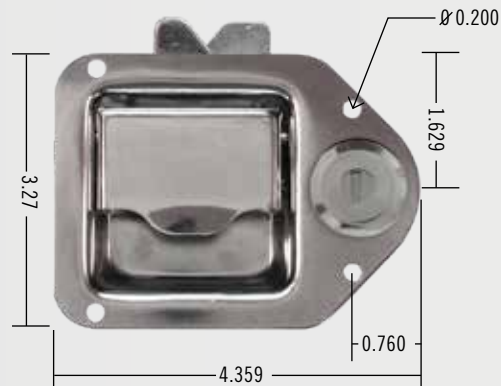

## BOLT CYLINDER

- Automotive Grade Quality
- Weather Proof
- Plate Tumbler Sidebar to Prevent Picking and Bumping
- Stainless Steel Lock Shutter to Keep Out Dirt and Moisture
- Limited Lifetime Warranty

Part Number	Description
692916	BOLT Cylinder Chrysler
692917	BOLT Cylinder Ford
7025636	BOLT Cylinder Ford Side Cut
692918	BOLT Cylinder GM Early Model (GM-A)
692915	BOLT Cylinder Late Model (GM-B)
7023480	BOLT Cylinder GM Center Cut *
7023481	BOLT Cylinder Nissan *
7023482	BOLT Cylinder Toyota *



Note: All dimensions are in inches

## CYLINDER RETAINING NUT

Part Number	Description
4306752	Retaining Nut

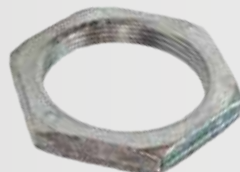

## GM TAILGATE HANDLE

- Original Factory Handle
- Included BOLT Cylinder
- Weather Proof
- Plate Tumbler Sidebar to Prevent Picking and Bumping
- Stainless Steel Lock Shutter to Keep Out Dirt and Moisture
- Limited Lifetime Warranty

Part Number	Description
5922987	GM Tailgate Handle (includes lock cylinder)
709231	Tailgate Lock Cylinder



2007-2013 CHEVROLET SILVERADO  
2007-2014 CHEVROLET SILVERADO HD  
2007-2013 GMC SIERRA  
2007-2014 GMC SIERRA HD

## JEEP SPARE TIRE LOCK

- Fits 1997 + Jeep JK
- Fits OEM Alloy Wheel Replacing One Lug Nut
- Weather Proof
- Double Ball Bearing Locking-Mechanism
- Plate Tumbler Sidebar to Prevent Picking and Bumping
- Stainless Steel Lock Shutter to Keep Out Dirt and Moisture
- Auto Return Spring Locks Automatically When Key is Removed
- Limited Lifetime Warranty

Part Number	Description
5922986	Jeep Spare Tire Lock

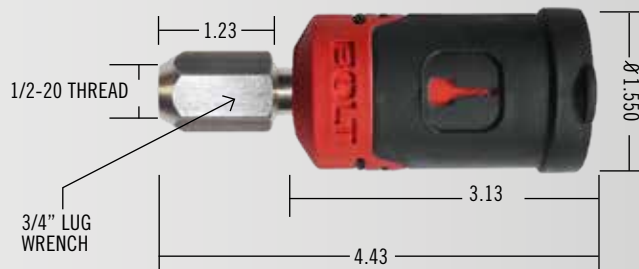
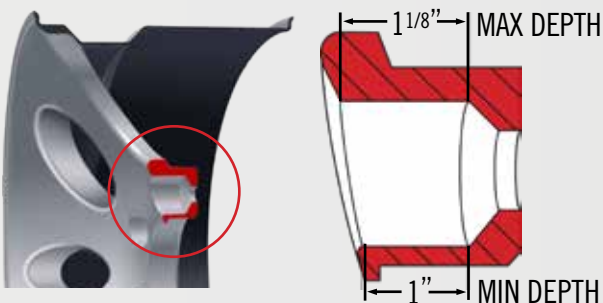

*Note: All dimensions are in inches*



FITS OEM ALLOY WHEEL REPLACING ONE LUG NUT

## JK HOOD LOCK

- Fits 2007 + Jeep TJ's + JK's
- Rivets into Existing Holes and Secures Your Under Hood Items from Theft
- Plate Tumbler Sidebar to Prevent Picking and Bumping
- Stainless Steel Lock Shutter to Keep Out Dirt and Moisture
- Limited Lifetime Warranty

Part Number	Description
7026128	JK Hood Lock

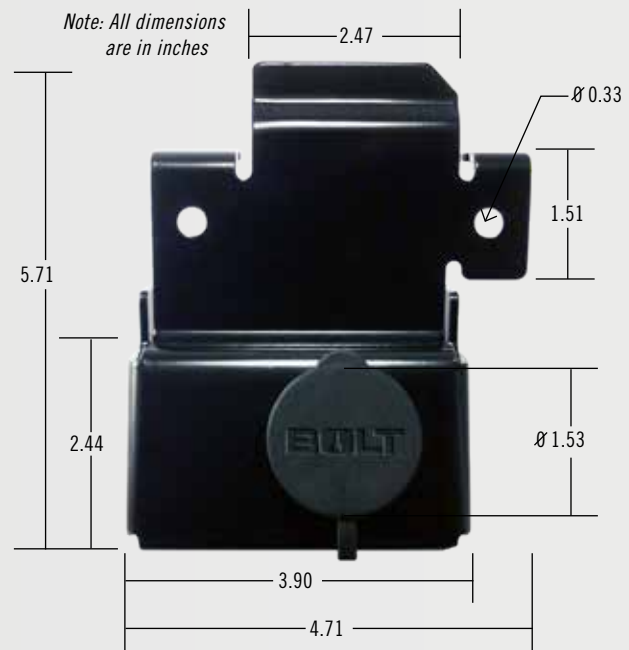

## J-MOUNT

- Fits 1997+ Jeep TJ & JK's
- Secure your Hi-Lift Jack with your Jeep key
- Hi-Lift Jack held securely in place with 2 knobs
- Easy to remove and mount your Hi-Lift Jack
- Auto Return Spring Locks Automatically When Key is Removed
- Plate Tumbler Sidebar to Prevent Picking and Bumping
- Easy to Install, Bolts into Existing Holes No Drilling Required!
- Weather Proof
- Limited Lifetime Warranty

Part Number	Description
7028648	J-Mount - Driver Side, Black
7028649	J-Mount - Passenger Side, Black
7028650	J-Mount - Driver Side, Red
7028651	J-Mount - Passenger Side, Red

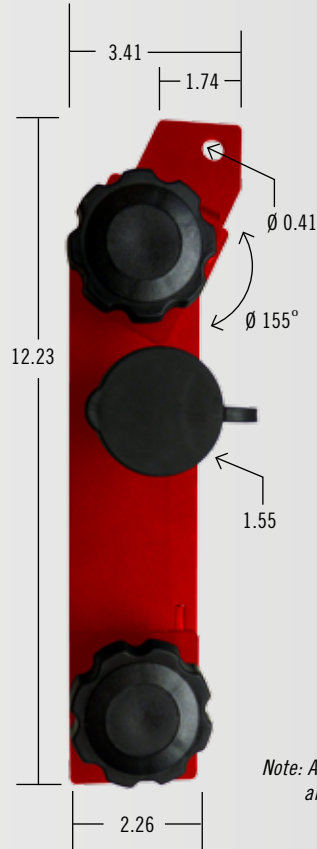

*Note: All dimensions are in inches*



# BOLT®

BREAKTHROUGH ONE-KEY LOCK TECHNOLOGY

Do you drive a truck, haul gear or pull a trailer? If so, this product is for you. The BOLT Series of locks lets you set all your truck, trailer and equipment locks to work with one key - your ignition key! Made by STRATTEC Security Corporation, the world's largest manufacturer of automotive locks and keys.



## HOW IT WORKS

USE YOUR SMART PHONE TO SCAN THE QR CODE TO SEE HOW THE BOLT LOCKS WORKS!



Follow us @BOLTlock on



FOR MORE INFORMATION, VISIT [BOLTlock.com](http://BOLTlock.com)

## Limited Lifetime Warranty

3333 West Good Hope Road | Milwaukee, WI 53209 | 844.972.7547

© 2016 STRATTEC SECURITY CORPORATION | All Rights Reserved | 4722382AG - 9.15