



**SB-2600**

“Important safeguards/general cautions” are information that can protect the user from safety hazards and also prevent losses. Please be sure to read the manual correctly for proper usage.

- Please read the manual carefully before installation and utilization.
- This product is made for the US and Canada.
- The function and design of the product may be changed for quality improvements.

## **READ ALL OPERATING INSTRUCTIONS BEFORE INSTALLATION.**

### *Notes*

- 1. This product should be installed according to this manual.*
- 2. Read this manual carefully and install properly.*
- 3. Retain this instruction manual in an easily accessible place.*
- 4. Do not attempt to service this product yourself unless instructed.  
Doing so will void the warranty.*

### **PREPARATION**

- 1 p1 Important safeguards*
- 2 p1 Cautions before installation*
- 3 p3 Identification*
- 4 p4 Safety information(DANGER)*
- 5 p6 Safety information(WARNING)*

### **USE**

- 6 p8 How to install*
- 7 p10 How to use*
- 8 p12 How to clean*
- 9 p13 Maintenance*
- 10 p14 Troubleshooting*

### **ETC**

- 11 p15 Specifications*
- 12 p16 Warranty*

# 1. Important Safeguards

---

## 1. READ ALL INSTRUCTIONS BEFORE USING

### **DANGER - To reduce the risk of electric shock:**

1. Do not place or store this product in a location where it can fall or be pulled into a tub or sink.
2. Do not place in, or drop into water or other liquids.
3. Do not touch a product that has fallen into water. Unplug immediately.

### **WARNING - To reduce the risk of burns, electric shock, fire or injury.**

1. Close supervision is necessary when this appliance is used by or is near infants, elders, or handicapped persons. Children should not be permitted to use or touch this appliance without adult supervision. Be sure to adjust the toilet seat's temperature for elders, handicapped persons, or people with sensitive skin.
2. Use this appliance only for its intended purpose as described in this manual. Do not use attachments not recommended by the manufacturer.
3. Do not operate this appliance if the cord is damaged or if the product is dropped into water.
4. Install the unit properly by following the installation procedure.
5. Only authorized persons can install or repair the unit. Do not attempt to service this appliance by yourself. Doing so could void the warranty.
6. Keep the cord away from heated surfaces.
7. Never drop or insert any objects into any opening or hose.
8. Do not use outdoors. Do not use aerosol or oxygen spray products on the unit.
9. Always follow the grounding instructions in this manual before plugging in the unit.

## SAVE THESE INSTRUCTIONS

# 2. Cautions before installation

---

## 1. NOTE THE FOLLOWING IMPORTANT POINTS

1. Do not install in a location where water might be splashed on this appliance or in a location exposed to excessive moisture where condensation might form on the product's surface.
2. To avoid damage to electronic components due to high levels of humidity, provide adequate ventilation by opening a window and/or door when bathing.
3. Water supply should have a water pressure of 0.07MPa to 0.74MPa.
4. Connect the product to a pipe carrying potable water. Do not connect to an industrial water line or other water supplies that are not potable.
5. Cool the unit in the room before installation.
6. The thermal protector in the water tank may malfunction when transporting or storing warm water.
7. The rated power voltage is 120V AC, 60Hz.
8. Do not plug the unit in until installation is complete. It may result in malfunction.

## 2. Cautions before installation

### 2. WIRING REQUIREMENTS

1. Any other servicing should be performed by authorized service representatives.

#### 2. GROUNDING INSTRUCTIONS

This product should be grounded. In the event of an electrical short circuit, grounding reduces the risk of electric shock by providing an escape wire for the electric current. This product is equipped with a cord having a grounding wire with a grounding plug. The plug must be plugged into an outlet that is properly installed and grounded.

**DANGER-Improper use of the grounding plug can result in a risk of electric shock.**

If the cord or plug is necessary to repair or needs to be replaced, do not connect the grounding wire to a flat blade terminal. The grounding wire can be identified by its insulated outer surface. It will either be colored green or will not contain yellow stripes.

Check with a qualified electrician or serviceman if you do not understand grounding instructions or if you do not know whether the product is properly grounded.

3. This product is for use on a nominal 120V circuit. It has a grounding plug that looks like the plug illustrated in sketch A. A temporary adapter, which looks like the adapter illustrated in sketches B and C, may be used to connect this plug to a 2-pole receptacle as shown in sketch B if a properly grounded outlet is not available. The temporary adapter should be used only until the properly grounded outlet (sketch A) can be installed by a qualified electrician. The green colored rigid ear, lug and the like extending from the adapter must be connected to a permanent ground such as a properly grounded outlet box cover. Whenever the adapter is used, it must be held in place by the screw.

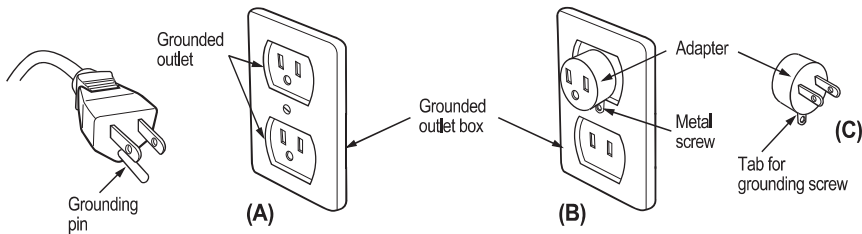

4. If it is necessary to use an extension cord, use only a three wire extension cord that has a three-blade grounding plug, and a three-slot receptacle that will accept the plug on the product. Replace or repair a damaged cord.

### 3. Identification

#### 1. Main unit

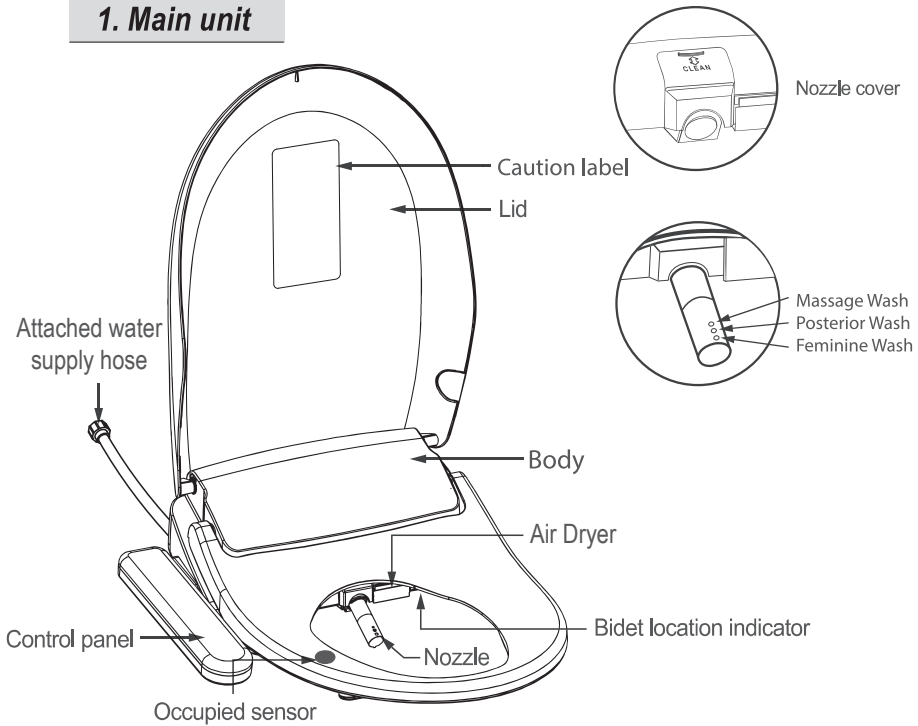

#### 2. Accessories

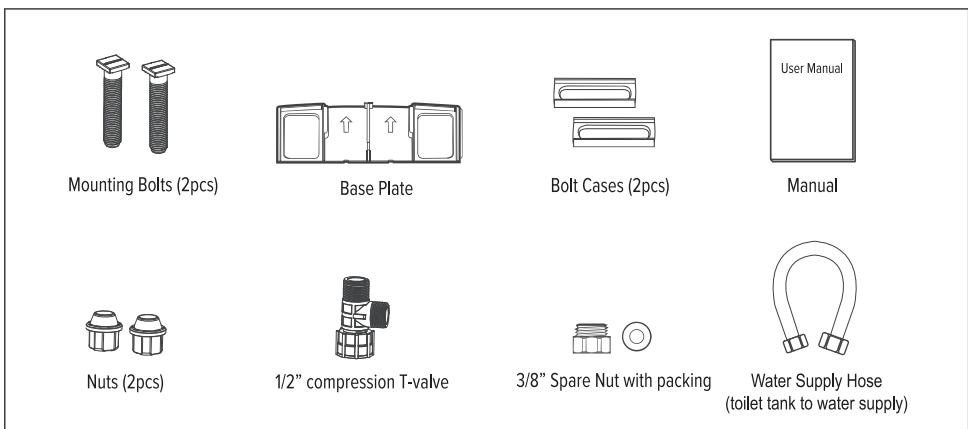

This unit has an attached water supply hose on the left side of the unit when facing it. This connects to your water supply. The water supply hose shown above connects to your toilet's water tank and your water supply.

# 4. Safety Information(DANGER)



**DANGER** Follow these basic instructions to ensure the safe use of your appliance

- Indicates a prohibited use of the appliance.
- Indicates a required step in use of this appliance.

Meanings of symbols

PROHIBITED	DO NOT HANDLE WITH WET HANDS
USE OF FIRE PROHIBITED	DO NOT DISASSEMBLE
DO NOT SPRAY WATER	GROUND CONNECTION
REQUIRED STEP	



**Do not use a faulty or loose electric outlet or cord**

Doing so may result in a short circuit, electric shock or fire.

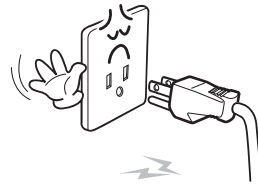

**Do not obstruct the warm air dryer outlet**

If the outlet is obstructed with any objects, it may result in fire.  
If the outlet is obstructed with hands, it may result in injury.



**Do not throw anything flammable into the toilet**

Doing so may result in fire.



**Do not splash water on this product**

Doing so may result in fire or electric shock.



**This product must be grounded**

Not doing so may result in short circuit, electric shock, or malfunction.





**DANGER** Follow these basic instructions to ensure the safe use of your appliance



PROHIBITED

**Do not use too many appliances on one power strip**

Doing so may result in fire or damage. Be sure to use a dry and clean outlet. Do not use a faulty or loose outlet.

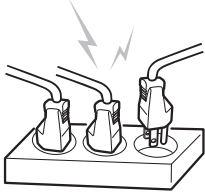

NO WET HANDS

**Plug and unplug properly**

Do not plug or unplug with wet hands. It may result in injury or short circuit. Do not grab the cord when unplugging. Pull out the plug properly.

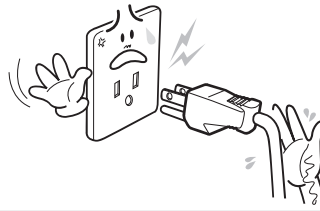

DO NOT DISASSEMBLE

**Do not use when the seat and lid are disassembled**

Doing so may result in electric shock due to high voltage inside.



REQUIRED

**Unplug when beeping or emitting a strange odor**

Unplug right away. Contact your dealer where you bought this appliance.



DO NOT DISASSEMBLE

**Do not disassemble, repair or modify this appliance**

Doing so may result in fire or electric shock.



PROHIBITED

**Use tap potable water only (ground water)**

Not doing so may cause irritation or injury.

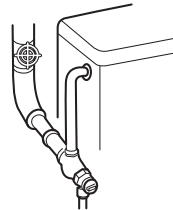

## 5. Safety Information(WARNING)



**WARNING** Follow these basic instructions to ensure the safe use of your appliance



**Do not step on or place heavy objects on this appliance**

Doing so may damage the unit.  
Doing so may result in malfunction of appliance.



**Do not force the lid to close**

Doing so may cause malfunction.



**Be aware of urine splash on a nozzle or on a dry air outlet**

Doing so may result in unpleasant odor or failure of appliance.



**Do not sit or lean against the lid or control panel**

Doing so may cause malfunction or breakage.



**Unplug if you do not plan to use for a long period of time**

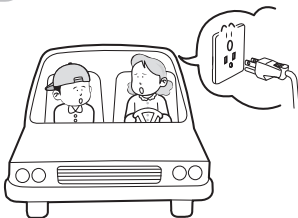

**Unplug while there is thunder or lightning**







## WARNING Follow these basic instructions to ensure the safe use of your appliance



PROHIBITED

### Do not pull out the waterhose forcefully

Doing so may cause water leakage.



REQUIRED

### Use this appliance on a toilet only

Not doing so may result in fire, injury or electric shock.



Improper use



PROHIBITED

### Do not put a vase, water cup or small materials on this appliance



PROHIBITED

### Be aware of low-grade burns

Sitting on the heated seat for a long time may result in a low-grade burn.

Use care when being used by the following:

- Children, senior citizens, patients, or others who can not control the temperature level
- Sleeping pill users or people who are on medication that causes drowsiness
- Those who are intoxicated or very tired may fall asleep while sitting on the unit



REQUIRED

### Unplug when cleaning

Not doing so may result in fire or electric shock.

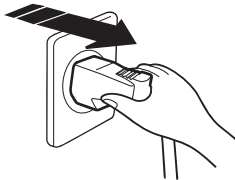

REQUIRED

### Use the low temperature for children and disabled

High temperature may result in burns due to not recognizing the temperature.

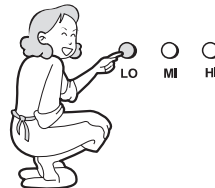

WARNING: Risk of electric shock, fire, or personal injury. This product must be grounded and connected only a dedicated, nominal 120 VAC, 60 Hz circuit protected by a minimum 15 A Ground-Fault Circuit-Interrupter (GFCI)

# 6. How to install



Do not plug in until installation is finished completely. Not doing so may damage the appliance.

※ If electric work is needed, please contact a qualified electrician or serviceman only.

## 1 Toilet size (Elongated)

The toilet dimensions must be within those shown below. Do not install this unit on a toilet that does not meet these dimensional requirements.

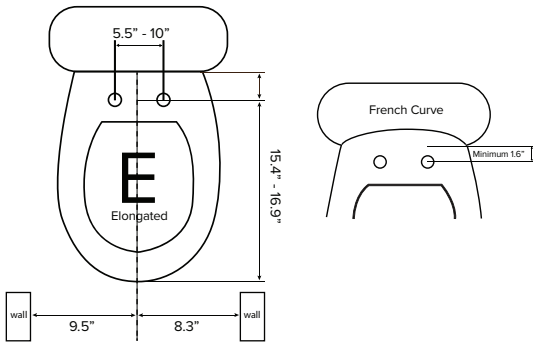

## Bidet Dimensions

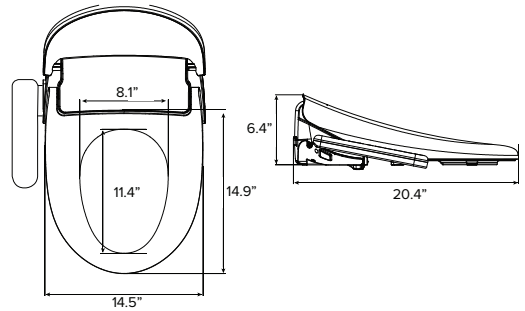

2 Remove your existing toilet seat, lid, and accessories and store them away.

## 3 How to mount the base plate

Place the base plate and bolt cases over each toilet mounting hole. Insert the mounting bolts through the base plate and toilet mounting holes. Screw in the nuts onto the mounting bolts.

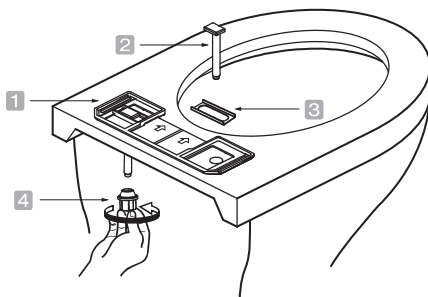

- 1 Base plate
- 2 Mounting bolt
- 3 Bolt case
- 4 Nut

## 4 How to attach and detach the unit

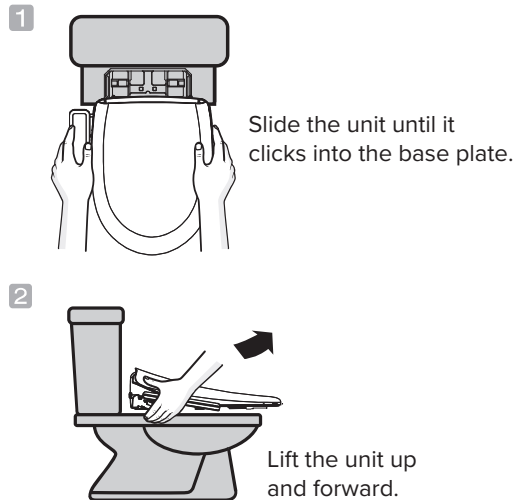

## Connecting the water hose

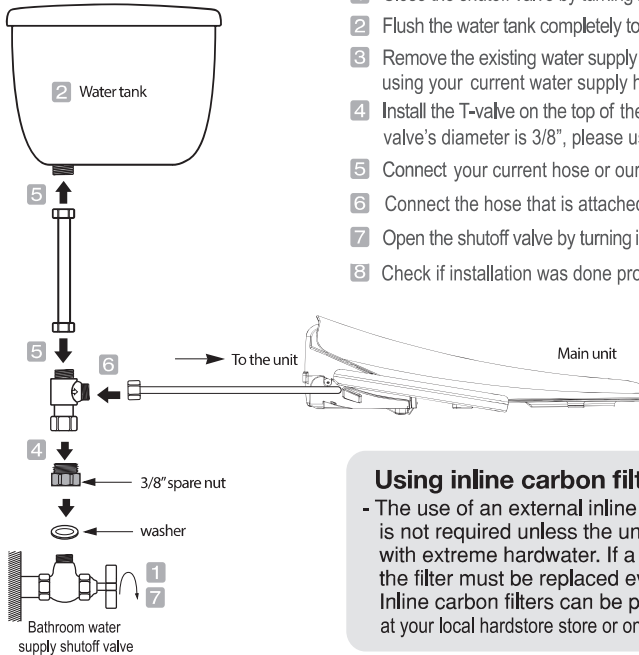

- 1 Close the shutoff valve by turning it clockwise.
- 2 Flush the water tank completely to empty.
- 3 Remove the existing water supply hose from the tank or you can continue using your current water supply hose.
- 4 Install the T-valve on the top of the water supply stop valve. If your water supply valve's diameter is 3/8", please use the 3/8" spare nut and washer.
- 5 Connect your current hose or our provided hose from the water tank to the t-valve.
- 6 Connect the hose that is attached to the main unit to the t-valve.
- 7 Open the shutoff valve by turning it counter clockwise.
- 8 Check if installation was done properly for any drips or leaks.

### Using inline carbon filter

- The use of an external inline carbon water filter is not required unless the unit is used in an area with extreme hardwater. If a carbon filter is used, the filter must be replaced every 3 months. Inline carbon filters can be purchased from at your local hardware store or online.

※ Water supply valves diameter may vary depending on your bathroom. If supplied parts do not fit, please purchase at your local hardware store.

*If a filter is used, it must be replaced every 3 months.*

*This product is designed and intended to exclusively use with SmartBidet water filters. The purchase or use of any other water filters is not the responsibility of SmartBidet. As such, any use of non SmartBidet water filters is prohibited and will void the warranty for those SmartBidet products. SmartBidet will not be responsible for any resulting damages nor claims related to the misuse or distribution of non SmartBidet water filters. SmartBidet is owned by Hitrons Solutions Inc.*

## Trial operation

### Occupied sensor

- This appliance is equipped with occupied sensor. Unit will not work unless seat is occupied.

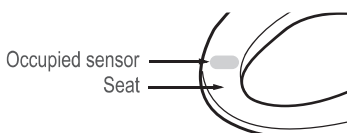

### Checking all functions

Use a bowl to cover the hole of the bidet seat to prevent water from spraying onto you then check all functions as described in this manual.

## 7. How to use

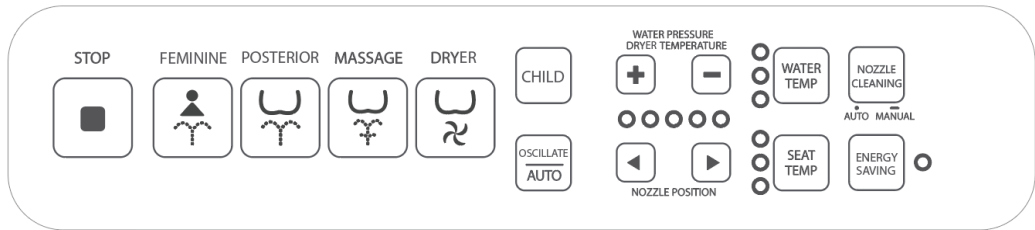

### Stop

- Press this button to stop current operation.
- When a user stands up, all operation will stop automatically. (Except for Child function)



### Feminine

- Press this button for feminine wash. The function will automatically stop in 2 minutes.
- Press the OSCILLATE button to activate the nozzle to move back and forth.
- This function has unlimited & on demand heated water.



### Massage

- Press this button to operate softer rhythmical water for 2min.
- Press 'MOVE' button to activate nozzle back and forth.
- Water pressure and nozzle position will set level 3. (You may change it when you use this function)



### Oscillation

- Press this button during the operation of Cleansing, Bidet, Massage to activate oscillation. The nozzle moves back and forth automatically to widen cleansing area.
- Oscillation wash stops if this button is pressed again.



### Nozzle Position

- Press this button during the operation of Cleansing, Bidet, Massage, Kids, Auto function, the nozzle position can be adjusted 5 levels.
- Nozzle position will remain.



### Nozzle Cleaning

- Auto: Press the button shortly to activate nozzle cleaning automatically.
- Manual: Press the button for 3 seconds to activate manual nozzle cleaning for 2 min. You may use brush to clean and press 'STOP' button to deactivate the manual function and nozzle will return with automatic cleaning.
- \* Seat Sensor must be off



### Posterior

- Press this button to clean your posterior. The function will stop in 2 minutes automatically.
- Press 'MOVE' button to activate nozzle back and forth.
- This function has unlimited & on demand heated water.



### Child Auto Wash & Dry

- Press this button to change all functions to be suitable for children. It will automatically operate from cleansing (1 min) to dry(3 min) with adequate water pressure and nozzle position.
- This unit should be used under the supervision of an adult.



### Dryer

- Press this button and warm air will come out for 3 minutes.
- Dryer temperature can be adjusted by pressing the + or - button up to 5 levels.



### Water Pressure

- Water spray pressure can be adjusted by pressing LOW or HIGH button to 5 levels.
- Water pressure level will remain.



### Temperature Adjustment (Water / Seat)

- Temperature of seat and water can be adjusted by pressing button.
- There are four levels, Room temp - Low - Medium - High.



### Energy Saving Mode

- Press this button will activate ENERGY SAVING function. (LED: Red -> Green)
- To deactivate, press the button again. (LED: Green -> Red)
- ENERGY SAVING will remain at 89.6°F at seat temperature and will return to the set temperature when the seat sensor is ON.
- You may disconnect the power plug when it is not in use for a long time.

## HOW TO SET BEEPING

- This product may turn on/off beeping mode with follow steps.
- Make sure the occupied sensor is not activated(Do not sit on the seat or place hands on the seat sensor).
- Please note that default mode is 'ON'.

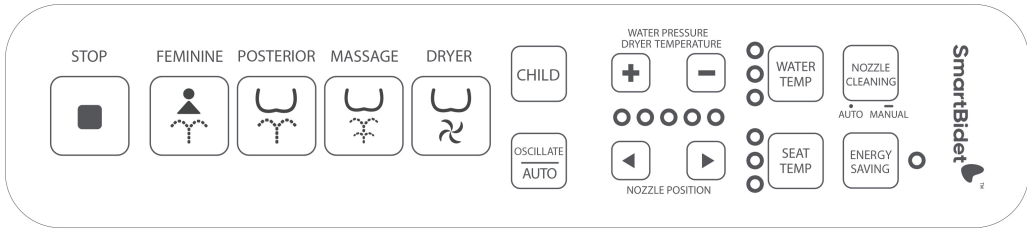

### STEP 1

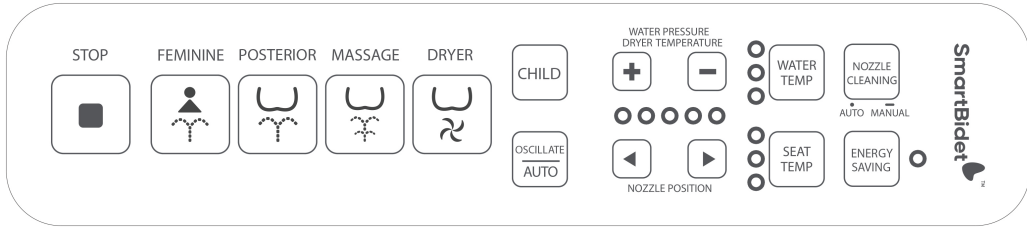

Press and hold  and  together for a sec to activate the set mode.

### STEP 2



Press and hold  and  together for a 3 secs to activate / deactivate beeping mode.

### STEP 3

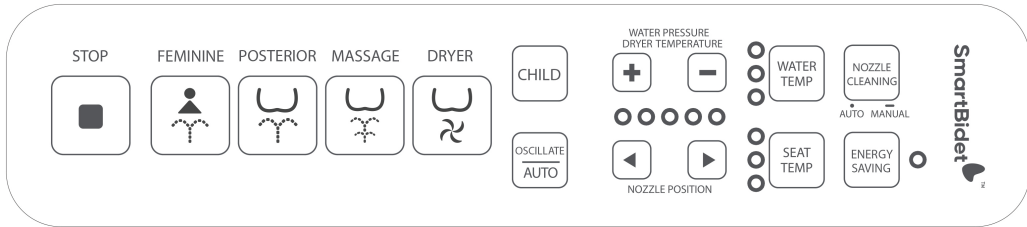

Press and hold  and  together for a sec to deactivate the set mode.

## 8. How to clean



Do not forcefully push or pull the nozzles, or bend them. It may result in failure.  
Make sure to use "Stop" button on the remote control.

### Nozzle self-cleaning function

- Self-cleaning function will automatically operate after cleaning function.
- Nozzle will spray water inside the unit and drain it.
- Press the 'Nozzle Cleaning' button will activate automatic self cleaning function.

### Nozzle cleaner

- Pull the Nozzle clean cover to disassemble.
- Press the 'Nozzle Cleaning' button for 3 seconds for manual cleaning.  
You may use soft brush to clean the nozzle. Nozzle will return after 2 minutes within automatic cleaning.
- Assemble Nozzle clean cover after you finish cleaning.

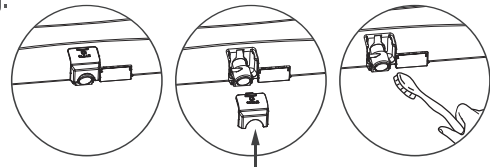

Nozzle clean cover

### Exterior cleaning

- 1 Regularly wipe off the seat with a dry soft cloth or sponge, or wash with a damp cloth and mild detergent.  
(Prints on control panel may erase due to use of detergent. Please wipe off with soft mop with water.)
- 2 In order to protect plastic unit, only use neutral cleansers.  
(Do not use toilet cleansers, home cleansers, bleach, benzene, paint thinner, cresol)



Toilet cleansers



Thinner  
Benzene



Bug killer



Sandpaper

## 9. Maintenance

### Strainer maintenance

This appliance will not operate properly if the strainer is clogged. Be sure to clean the strainer regularly.

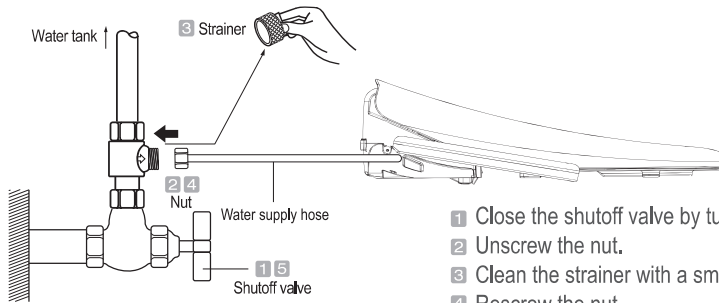

- 1 Close the shutoff valve by turning it clockwise.
- 2 Unscrew the nut.
- 3 Clean the strainer with a small brush.
- 4 Rescrew the nut.
- 5 Open the shutoff valve by turning it counter clockwise.

### Preventing freezing

- 1 Make sure the power cord is properly plugged in.

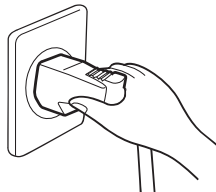

- 2 Set the water temperature to low or middle.  
■ If there is no heating system in the toilet, wrap pipes with cloth or other materials.

# 10. Troubleshooting

PROBLEM	POSSIBLE CAUSE	POSSIBLE SOLUTION
Unit completely fails to work or power on	<ol style="list-style-type: none"> <li>1. Power outage</li> <li>2. Unit is not plugged in</li> <li>3. Faulty receptacle</li> <li>4. Skin sensor is not activated</li> </ol>	<ol style="list-style-type: none"> <li>1. Reset the GFI outlet</li> <li>2. Plug the power cord in to a GFI outlet</li> <li>3. Test another appliance in the outlet</li> <li>4. Activate the skin sensor on the unit</li> </ol>
Nozzle does not extend	<ol style="list-style-type: none"> <li>1. Nozzle is dirty</li> <li>2. External bidet filter</li> <li>3. Skin sensor is not activated</li> <li>4. Seat riser is covering the skin sensor</li> </ol>	<ol style="list-style-type: none"> <li>1. Clean the nozzle</li> <li>2. Remove the external bidet filter</li> <li>3. Activate the skin sensor on the unit</li> <li>4. The seat riser must go underneath the bidet seat</li> </ol>
Low water pressure	<ol style="list-style-type: none"> <li>1. Clogged nozzle tip</li> <li>2. Water pressure is set to low on the control panel</li> </ol>	<ol style="list-style-type: none"> <li>1. Clean the nozzle tip</li> <li>2. Raise the water pressure on the control panel</li> </ol>
Seat is not heating	<ol style="list-style-type: none"> <li>1. Unit is set on Energy Saving mode</li> </ol>	<ol style="list-style-type: none"> <li>1. Turn off Energy Saving mode</li> <li>2. Unplug the unit for 10 sec</li> </ol>
Stops in the middle of use	<ol style="list-style-type: none"> <li>1. Washing or drying exceeded cycle time</li> <li>2. Skin sensor lost contact</li> </ol>	<ol style="list-style-type: none"> <li>1. Press the wash or dry mode again</li> <li>2. Activate the skin sensor with full skin contact through the entire cleansing period</li> </ol>
Water coming out from the nozzle unexpectedly	<ol style="list-style-type: none"> <li>1. Self-cleaning</li> </ol>	<ol style="list-style-type: none"> <li>1. The unit will self-clean the nozzle before and after each use automatically</li> </ol>
Water leaking continuously	<ol style="list-style-type: none"> <li>1. Leaking from hose connection at the unit</li> <li>2. Leaking from T-valve</li> </ol>	<ol style="list-style-type: none"> <li>1. Check to make sure that all rubber washers are in place and do not over tighten the connection but it should be secure</li> <li>2. Check to make sure that the rubber washer is in place with the flat side pointing up</li> </ol>



# 11. Specifications

Model		SB-2600
Rated Voltage		120 Volts, 60Hz
Max Consumption Power		1,260W
Water supply type	Type	Direct-coupled water supply system
	Water Inlet Pressure	0.07~0.74 MPa
Water Temperature Wash	Posterior (ℓ /min)	0.6 ℓ /min
	Feminine (ℓ /min)	0.55 ℓ /min
	Water & dryer pressure adjustments	5 Levels
	Water temperature adjustments	4 Levels (Off, Low, In the, High)
	Water temperature heating	1,200W
	Backflow protection devices	For vacuum to prevent, Check valve
	Safety devices	Manually place two metal strips
Constant Temperature Toilet seat	Seat Temperature Control	4 Levels (Off, Low, In the, High)
	Seat Heating	55W
	Safety devices	Overheating prevention temperature fuse
Dryer	Dryer Temperature	Room temperature - 131°F, 5 Levels
	Dryer Heat	250W Actual heating power CA(168W)
	Safety Devices	Thermal fuse
Power cord length		3'10"
Energy Saving Mode		Yes
User water temperature		53.6°F - 93.2°F (2°C ~ 34°C)
Environment temperature		37.4°F - 104°F (3°C ~ 40°C)

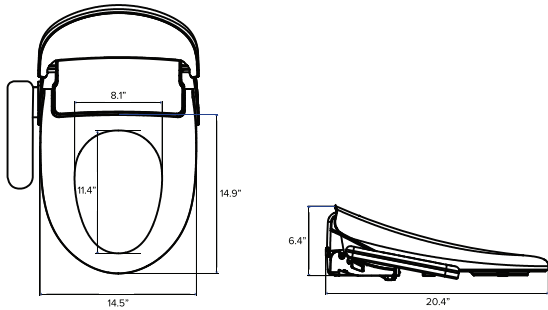
Product weight	8.2 lbs
Product Dimensions	 <p>Appearance size : 19.1" W x 20.9" D x 8.1" H</p>

- ※ Recommended water supply pressure are 0.1~0.69MPa
- ※ The minimum available water supply pressure is 0.07MPa, however under 0.1MPa pressure, water spray pressure might not be adequate.

## 12. Warranty

General Limited Warranty Covered **Hitrons Solutions Inc** will warrant to the original retail buyer only, which falls in normal use and within the applicable periods specified below.

**Hitrons Solutions Inc** replacements will be warranted to the original purchaser of the products only.

The Parts Warranty If the parts fail within Twelve(12)months after original purchase from authorized retailer, following the installation manual and normal operation, **Hitrons Solutions Inc** will furnish replacement part(s) after warranty registration.

1. Defects and/or malfunctions from failure to properly install, operate and/or maintain the unit in accordance with the installation manual.
2. Damage from abuse, fire, flood, freeze, and any other acts of Nature.
3. Damage resulting from unauthorized alterations, attachments and/or repairs.
4. If the product was not installed properly.
5. Damage to the unit by animals, mice or insects.
6. Damage caused by excess moisture or from water clogging the bathroom or restroom.
7. Damage from not being installed in accordance with all applicable local codes, ordinances and good trade practices.
8. Color fading due to use in wrong environment.
9. Damage from chemicals.
10. The warranty will not be covered without providing the date of purchase with original receipt.

Customer Service Center

---



**HiTRONS**  
SOLUTIONS INC



ADDRESS  
88 Portland Avenue Suite M  
Bergenfield, NJ 07621



TOLL-FREE NUMBER  
1-800-515-3430  
Monday to Friday  
9:00am to 5:00pm EST



EMAIL  
cs@smartbidet.net  
[www.smartbidet.net](http://www.smartbidet.net)