

DOCUS MINI

08-Apr.-2017

1.0

PAR16 max. 15W | GU10 | 100-240VAC | 50-60Hz

CE IP20 0,9m

white texture	300320W0
aluminium brushed	300320L0
gold	300320G0
copper	300320P0
black texture	300320B0

OPTIONAL
for PAR16 lamps see our catalogue

2.0

2xPAR16 max. 15W | GU10 | 100-240VAC | 50-60Hz

CE IP20 0,9m

white texture	301320W0
aluminium brushed	301320L0
gold	301320G0
copper	301320P0
black texture	301320B0

OPTIONAL
for PAR16 lamps see our catalogue

DOCUS MINI 1.0

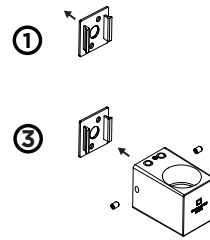

DOCUS MINI 2.0

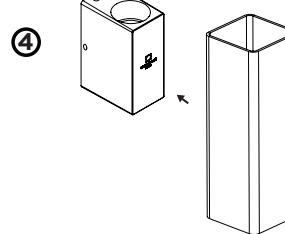
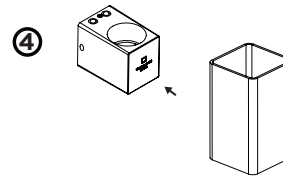
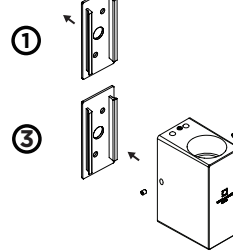

FOR OPTIONAL LOCKING:

* Lock the cover by unscrewing the grub screw app. 3mm. Then the cover is stable.

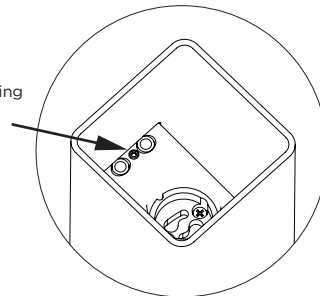

5

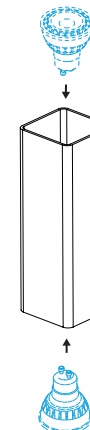

5

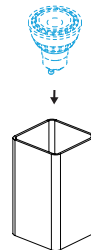

DIMENSIONS

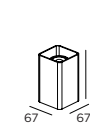

DOCUS MINI 1.0

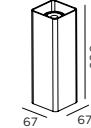

DOCUS MINI 2.0

MOUNTING INSTRUCTION

- 1 Mount the base plate on the wall

POWER CONNECTION

- 2 Connect the power supply.

Interior: STANDARD version

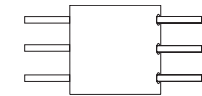

- 3 Mount inset on the back plate with side screws

- 4 Click cover over the inset

* For optional locking, unscrew the grub screw app. 3mm. The cover is now stable.

- 5 Mount the bulb.

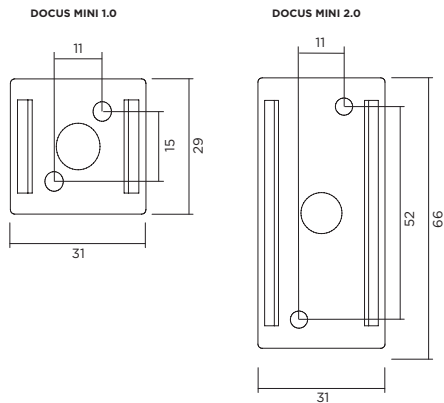

WEVER & DUCRÉ
LIGHTING

www.weverducre.com

Wever & Ducre bvba Kwadestraat 153 bus 2.1 8800 Roeselare

**INSTALLATION
INSTRUCTIONS**