

MAP

25-Sep.-2017

0.6
LED 5W 220-240VAC 50-60Hz COB 3-step incl. power supply
CE IP67 0.3m 38°
3000K >80CRI 150lm
inox 75116314
OPTIONAL recessed housing 90012201

0.9
LED 8W 220-240VAC 50-60Hz COB 3-step incl. PS phase-cut dim
CE IP67 0.3m 38°
3000K >80CRI 480lm
inox 75126414
OPTIONAL recessed housing 90012202

1.2
LED 12W 220-240VAC 50-60Hz COB 3-step incl. PS phase-cut dim
CE IP67 0.3m 38°
3000K >80CRI 750lm
beam angle 38°
inox 75136414
OPTIONAL recessed housing 90012203

1.6
LED 15W 220-240VAC 50-60Hz COB 3-step incl. PS phase-cut dim
CE IP67 0.3m 38°
3000K >80CRI 950lm
beam angle 38°
inox 75146414
OPTIONAL recessed housing 90012204

with recessed housing

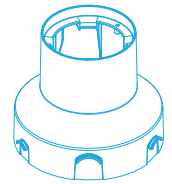
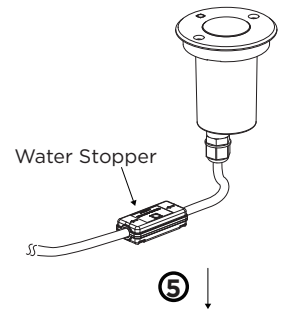

OPTIONAL, (ORDER SEPARATELY)
recessed housing

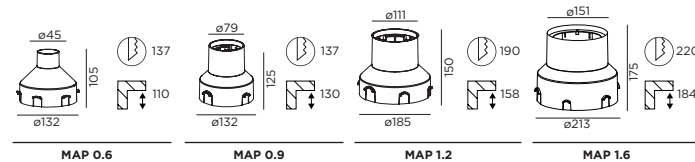

DIMENSIONS

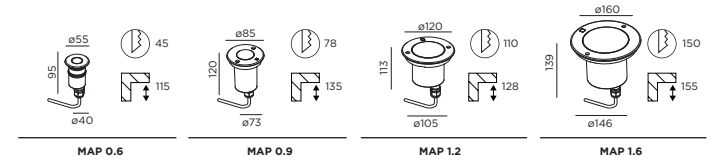

MOUNTING INSTRUCTION

- Remove the protective foam inside of the MAP. Make sure to screw the screws back on, crosswise, to ensure IP67.
- Make a hole in the ground according to the prescribed dimensions (of the recessed housing).
- Drainage: we recommend that all exterior groundspots should be installed with a drainage level even when using a recessed housing.

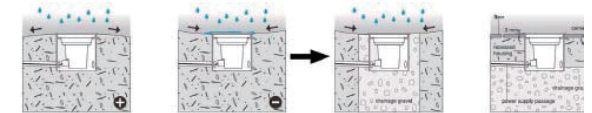

POWER CONNECTION

- Exterior: WATERPROOF Connection

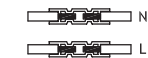

Remark: Do not open or cut off the Water Stopper on cable.

- MOUNTING WITH RECESSED HOUSING**

Use the bolts and the nuts to attach the MAP to the recessed housing

Caution, risk of electric shock
The light source of the integrated LED is not replaceable; When the light source reaches its end of life the whole luminaire shall be replaced.

85° The MAP 0.6 has an auto-recovery thermal fuse. In order to avoid product early failure in some extreme condition; If the internal components reach a temperature of 85°C, the product will switch off and then restart when cooling down.

MAP

25-Sep.-2017

without recessed housing

A. Attached to the floor (or wall, for wall mounting)

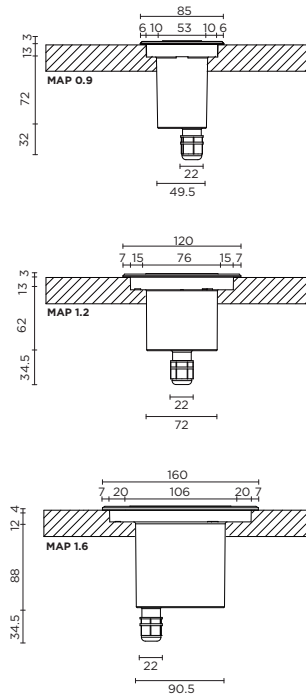
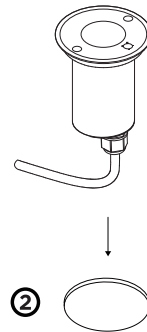





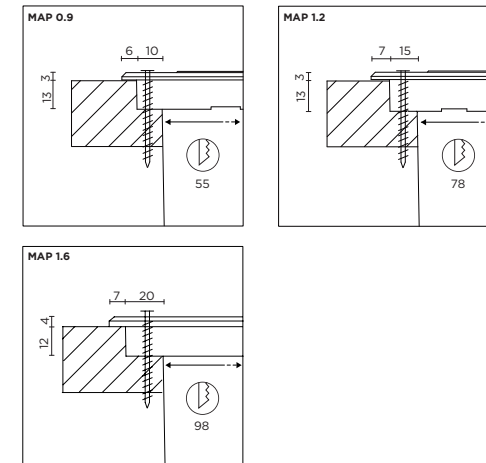











A. Attached to the floor (or wall, for wall mounting)

- ⑤ Use the screws to attach the MAP to the floor or wall. Make sure to measure correctly so that you can screw onto a hard material. This type of installation is not possible for MAP 0.6



85 The MAP 0.6 has an auto-recovery thermal fuse. In order to avoid product early failure in some extreme condition; If the internal components reach a temperature of 85°C, the product will switch off and then restart when cooling down.

 Caution, risk of electric shock
The light source of the integrated LED is not replaceable; When the light source reaches its end of life the whole luminaire shall be replaced.

0.6	LED 5W 220-240VAC 50-60Hz COB 3-step incl. power supply
CE  IP67  0.3m  38° 	
3000K >80CRI 150lm	751163I4
inox	
OPTIONAL	
recessed housing	90012201
0.9	LED 8W 220-240VAC 50-60Hz COB 3-step incl. PS phase-cut dim
CE  IP67  0.3m  38° 	
3000K >80CRI 480lm	751264I4
inox	
OPTIONAL	
recessed housing	90012202
1.2	LED 12W 220-240VAC 50-60Hz COB 3-step incl. PS phase-cut dim
CE  IP67  0.3m  38° 	
3000K >80CRI 750lm	751364I4
beam angle 38°	
inox	
OPTIONAL	
recessed housing	90012203
1.6	LED 15W 220-240VAC 50-60Hz COB 3-step incl. PS phase-cut dim
CE  IP67  0.3m  38° 	
3000K >80CRI 950lm	751464I4
beam angle 38°	
inox	
OPTIONAL	
recessed housing	90012204



WEVER & DUCRÉ
LIGHTING

www.weverducre.com

Wever & Ducre bvba Kwadestraat 153 bus 2.1 8800 Roeselare

**INSTALLATION
INSTRUCTIONS**

PAGE 2/3

MAP

25-Sep.-2017

without recessed housing

B. Rests on the stainless steel borders of the fixture

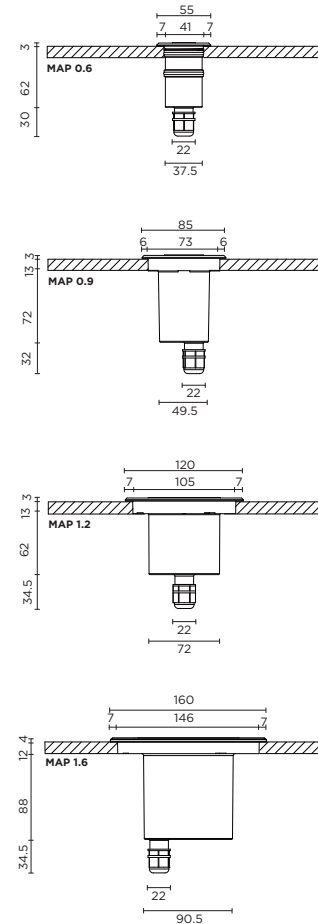
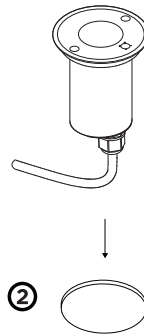

B. Rests on the stainless steel borders of the fixture

- Place the MAP into the hole, no tools needed to fix it into the hole. Just let it rest on the stainless steel borders of the fixture

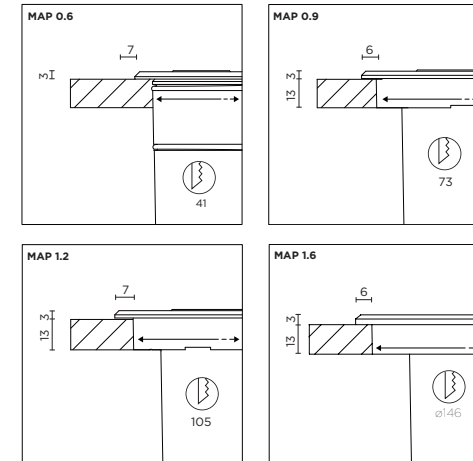

85 The MAP 0.6 has an auto-recovery thermal fuse. In order to avoid product early failure in some extreme condition; If the internal components reach a temperature of 85°C, the product will switch off and then restart when cooling down.

Caution, risk of electric shock The light source of the integrated LED is not replaceable; When the light source reaches its end of life the whole luminaire shall be replaced.

<p>0.6 LED 5W 220-240VAC 50-60Hz COB 3-step incl. power supply CE IP67 0.3m 38° 3000K >80CRI 150lm inox 75116314 OPTIONAL recessed housing 90012201</p>
<p>0.9 LED 8W 220-240VAC 50-60Hz COB 3-step incl. PS phase-cut dim CE IP67 0.3m 38° 3000K >80CRI 480lm inox 75126414 OPTIONAL recessed housing 90012202</p>
<p>1.2 LED 12W 220-240VAC 50-60Hz COB 3-step incl. PS phase-cut dim CE IP67 0.3m 38° 3000K >80CRI 750lm beam angle 38° inox 75136414 OPTIONAL recessed housing 90012203</p>
<p>1.6 LED 15W 220-240VAC 50-60Hz COB 3-step incl. PS phase-cut dim CE IP67 0.3m 38° 3000K >80CRI 950lm beam angle 38° inox 75146414 OPTIONAL recessed housing 90012204</p>