

SOLID

10-Apr.-2017

1.0 LED

LED 8W | 220-240VAC | 50-60Hz | COB 3-step |incl. PS | phase-cut dim

CE IP20 0,3m 36° 25°/25° 355°

white texture	133164W
white texture + gold	133164J
black texture + gold	133164K
copper	133164P
black texture	133164B

LIGHT COLOUR

2700K >90CRI 470lm	3
3000K >90CRI 470lm	5
1800-2850K >95CRI 410lm	9

1.0 PAR16

PAR16 max. 35W | GU10 | 100-240VAC | 50-60Hz

CE IP20 0,9m 25°/25° 355°

white texture	133120W0
white texture + gold	133120J0
black texture + gold	133120K0
copper	133120P0
black texture	133120B0

OPTIONAL

for PAR16 lamps see our catalogue

base plate dimensions

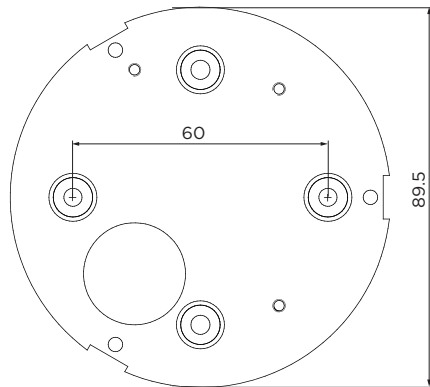

1.0 LED

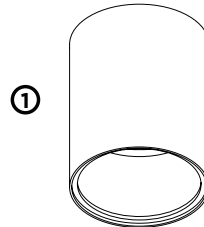

①

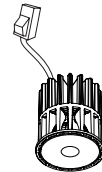

③

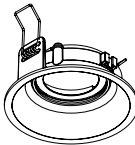

④



1.0 PAR16

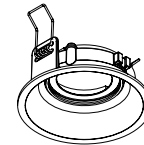
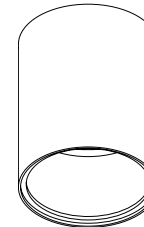

DIMENSIONS



1.0 LED



1.0 PAR16

① MOUNTING INSTRUCTION

Attach the SOLID base plate to the ceiling with screws.

② POWER CONNECTION

Connect to power
Interior connection : standard version

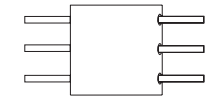

③ Insert the light module (PAR16/LED ENGINE) into the module and fix with spring.

④ Click the module into the SOLID base fixture with the springs.



WEVER & DUCRÉ
LIGHTING

www.weverducre.com

Wever & Ducre bvba Kwadestraat 153 bus 2.1 8800 Roeselare

INSTALLATION
INSTRUCTIONS