

Custom Acrylic Handrail Kits

Handrail Kits Include all Necessary Components

ASSEMBLED HANDRAIL

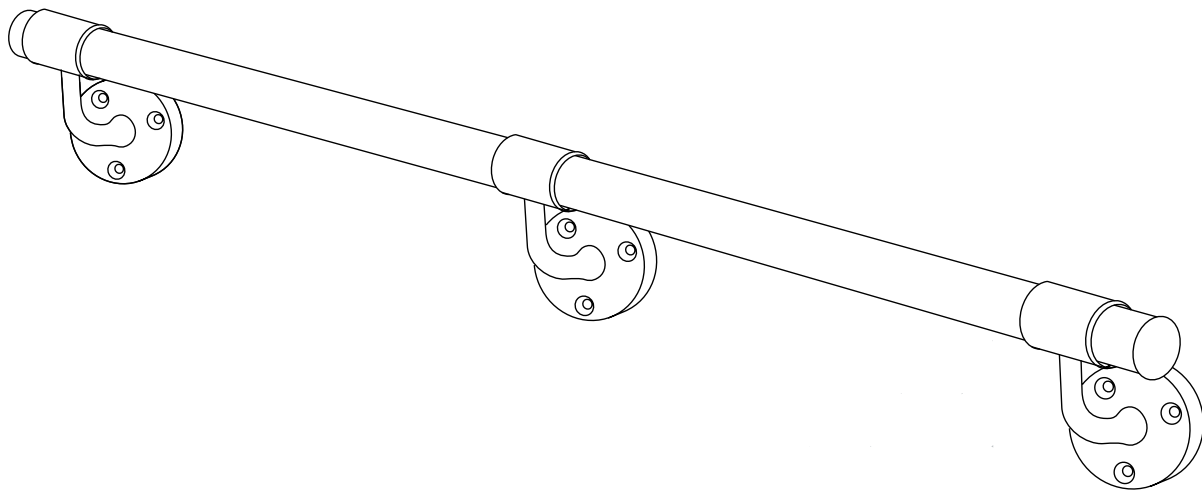

Step-by-step instructions

1. Mark the wall at regular intervals down the length of the stairs at a position 34" vertically from the pitch line.
2. Recommended spacing should not exceed 48". Rods are to be joined together at the bracket.
3. Once you have the right height and position of the bracket, begin to attach the brackets loosely to the wall with one screw.
4. Place the tube on the brackets and adjust the brackets for proper angle before you securely tighten the brackets to the wall with the rest of the bracket screws.
5. Securely tighten tube to brackets with screws.

Note: Position bracket before removing film from the acrylic rod. Once you have finalized the position of the bracket, remove the film. (Do not use a sharp object to remove film).

2-ft Handrail Kit
1-2' Tubes
2 Brackets



4-ft Handrail Kit
1-4' tube
2 Brackets

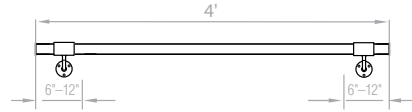

5-ft Handrail Kit
1-5' Tubes
2 Brackets

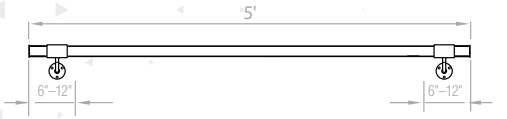

6-ft Handrail Kit
1-6' tube
3 Brackets

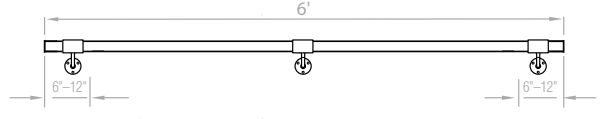

8-ft Handrail Kit
2-4' Tubes
3 Brackets

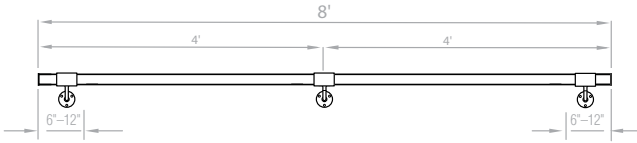

10-ft Handrail Kit
2-5' Tubes
3 Brackets

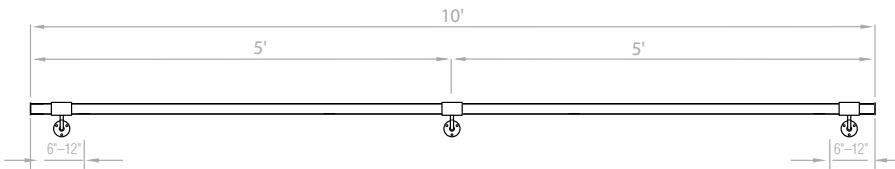

12-ft Handrail Kit
2-6' Tubes
3 Brackets

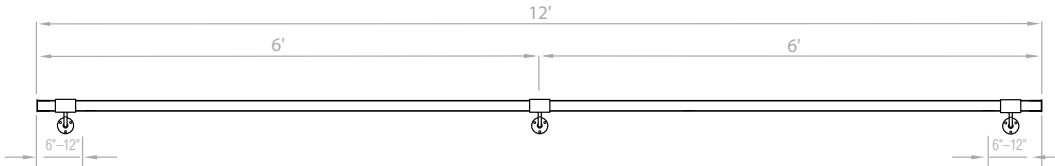

15-ft Handrail Kit
3-5' Tubes
4 Brackets

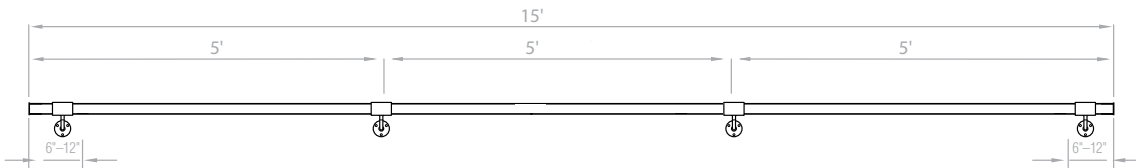

16-ft Handrail Kit
4-4' Tubes
5 Brackets

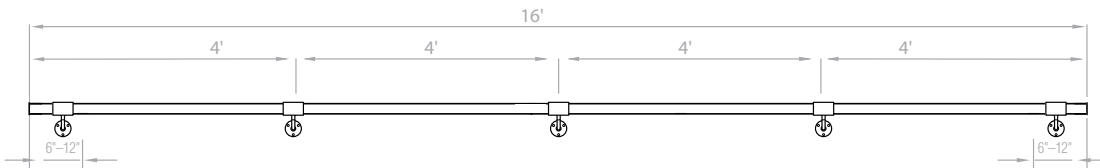

18-ft Handrail Kit
3-6' Tubes
4 Brackets



For shipping, ease of assembly, and safety, larger handrails are split into smaller lengths to be joined together at the bracket.