



DUKERS

Quality Commercial Refrigeration



SALAD PREP TABLE

DSP48-18M-S2
2-Door / Mega Top



TECHNICAL SPECIFICATIONS

Voltage/Frequency	115V/60Hz
Refrigerant	R290
Type of Defrost	Automatic
Interior Material	Stainless Steel
Exterior Material	Stainless Steel
Temperature Range °F	33 ~ 41°F
Compressor Power (HP)	1/5
Nema Config.	NEMA5-15P



PRODUCT FEATURES

- The compressor is mounted in the back and placed in the coolest possible area; this makes it easily accessible for servicing.
- Digital temperature controls with LED display for precise adjustment and automatic defrosting system.
- Temperatures in the cabinet range from 33 to 41 degrees Fahrenheit
- Higher Resistance to dust, high quality condenser.
- R290 Natural Refrigerant promotes faster cool down and efficient energy consumption.
- Self-closing doors at 60° with stay open feature.
- Stainless steel interior & exterior, sealed interior floors, and rounded cabinet corners for easy cleaning.
- 6" deep 1/6 plastic plan included.
- High quality coated stainless adjustable shelves prevent peel and rust.
- Lifetime warranty on hinges.
- 6" casters with lock for easy mobility.



HIGH QUALITY STAINLESS STEEL & ROBUST DESIGN



DUKERS

Los Angeles | San Francisco | Dallas
Houston | Florida | Chicago | New Jersey

1-800-931-8628

@ info@dukersusa.com

www.DukersUSA.com

DETAILS & SPECIFICATIONS

SALAD PREP TABLE DSP48-18M-S2

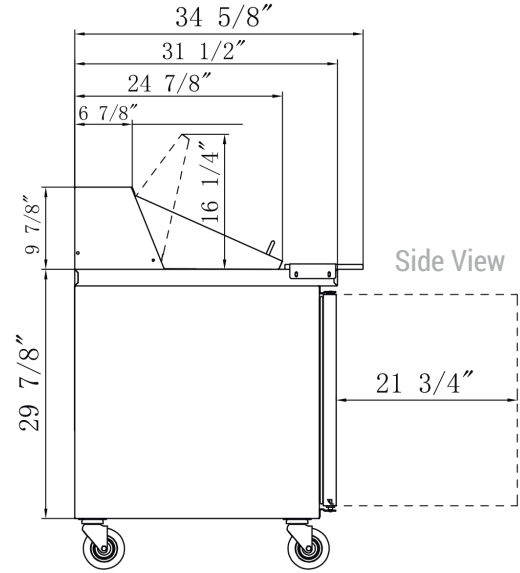
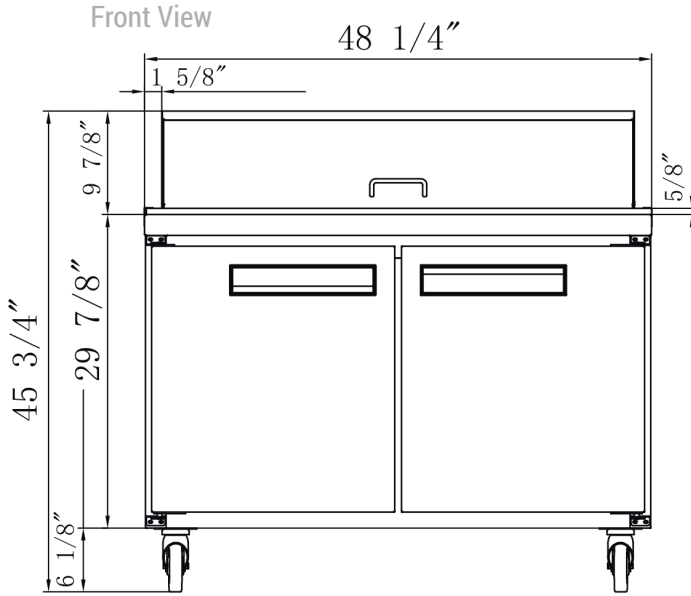

MODEL DSP48-18M-S2

Cutting Board Size	48 x 9
Rated Voltage	115V
Rated Frequency	60Hz
Total Input Power	280W
Total Current	2.4A
Total Capacity	11.47 cu ft
Climatic Category	4-5
Protection Type	I
Design Pressure High Side	300 PSIG
Design Pressure Low Side	150 PSIG
Insulation Blowing Gas	C-Pentane
Refrigerant	R290/3.17oz

1/6 PAN COUNT: 18



MODEL	EXTERNAL DIMENSION WXDXH (INCHES)	PACKAGING DIMENSION WXDXH (INCHES)	PRODUCT NET WEIGHT	# OF SHELVES	40HQ CONTAINER CERT.
DSP48-18M-S2	48 1/4 x 31 1/2 x 46	52 1/2 x 35 7/8 x 48 3/8	231 lbs	2	42



AutoQuotes



115/60/1
NEMA-5-15P



Los Angeles | San Francisco | Dallas
Houston | Florida | Chicago | New Jersey

1-800-931-8628

@ info@dukersusa.com

www.DukersUSA.com