



DUKERS
Commercial Refrigeration
Equipment



DUKERS
Quality Commercial Refrigeration



GLASS DOOR MERCHANDISER

DSM-48R

2-Door / Glass / Swing / Refrigerator









TECHNICAL SPECIFICATIONS

Voltage/Frequency
115V/60Hz
Refrigerant
R290
Type of Defrost
Automatic
Interior Finish
White
Exterior Finish
Black
Temperature Range °F
33 ~ 40°F
Compressor Power (HP)
1/2 -
Nema Config.
NEMA5-15P



PRODUCT FEATURES

-  The compressor is mounted in the bottom for better heat evaporation.
-  Digital temperature controls with LED display for precise adjustment and automatic defrosting system.
-  Temperature Range 33 ~ 40°F, with auto defrost function, which ensures optimal performance day-in and day-out.
-  R290 Natural Refrigerant promotes faster cool down and efficient energy consumption.
-  Interior and canopy LED light with switch on the right side to always show your products at their best
-  High quality coated stainless adjustable shelves prevent peel and rust.
-  Anti-fogging tempered glass door helps ensure a crystal clear view of the interior.



HIGH QUALITY & ROBUST DESIGN

DUKERS

Los Angeles | San Francisco | Dallas
Houston | Florida | Chicago | New Jersey

 1-800-931-8628

 info@dukersusa.com

www.DukersUSA.com

DETAILS & SPECIFICATIONS

DSM-48R

Front View

Side View

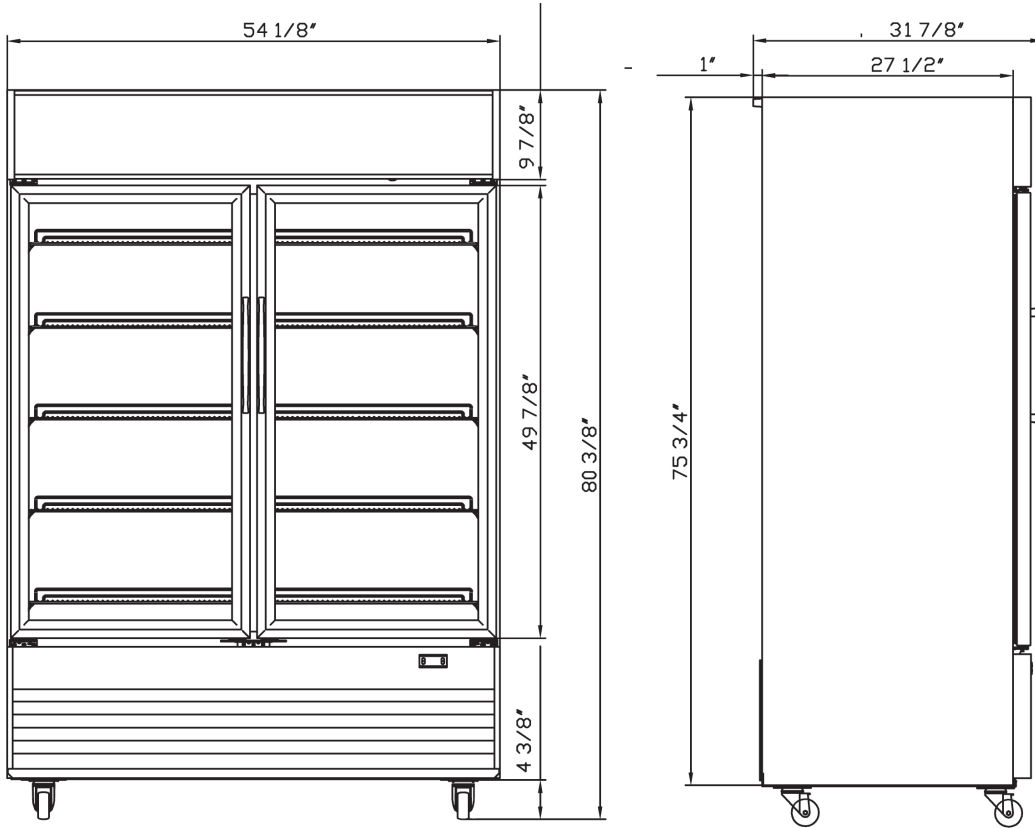

MODEL DSM-48R

Rated Voltage	115V
Rated Frequency	60Hz
Total Input Power	690W
Total Current	9.8A
Total Capacity	48.73 cu ft
Climatic Category	4-5
Protection Type	I
Design Pressure High Side	300 PSIG
Design Pressure Low Side	150 PSIG
Insulation Blowing Gas	C-Pentane
Refrigerant	R290/5.11 oz

MODEL	EXTERNAL DIMENSION WXDXH (INCHES)	PACKAGING DIMENSION WXDXH (INCHES)	PRODUCT NET WEIGHT	# OF SHELVES	40HQ CONTAINER CERT.
DSM-48R	54 1/8 x 31 7/8 x 80 3/8	56 1/8 x 32 7/8 x 82 3/8	385 lbs	10	



AutoQuotes



115/60/1
NEMA-5-15P



Los Angeles | San Francisco | Dallas
Houston | Florida | Chicago | New Jersey

1-800-931-8628

@ info@dukersusa.com

www.DukersUSA.com