

Item # _____

Qty # _____

Model # _____

Project # _____



DUKERS
Quality Commercial Refrigeration



GRIDDLE DCGM24



Waste Tray



Oil Tray



PRODUCT DESCRIPTION

- ✦ Stainless steel exterior and interior.
- 🔥 30,000 BTU Burners per 12" section with standby pilots.
- 🕒 Independent manual controls every 12".
- 🍳 Heavy duty 3/4" thick polished steel griddle plate.
- 📏 Each griddle is shipped with Standard Natural Gas, LP conversion kit.
- 📏 Adjustable, stainless steel legs standard.
- 💡 Full length seamless drip pan, easy to remove and clean.



HIGH QUALITY STAINLESS STEEL & ROBUST DESIGN

* All measures are presented in Inches

GRIDDLE
MODEL

DIMENSION

Width Depth Height

DCGM24

24 in

30 in

15 1/4 in



Los Angeles | San Francisco | Dallas
Houston | Florida | Chicago | New Jersey

1-800-931-8628

@ info@dukersusa.com

www.DukersUSA.com

DETAILS & SPECIFICATIONS

GRIDDLE DCGM24

Front View

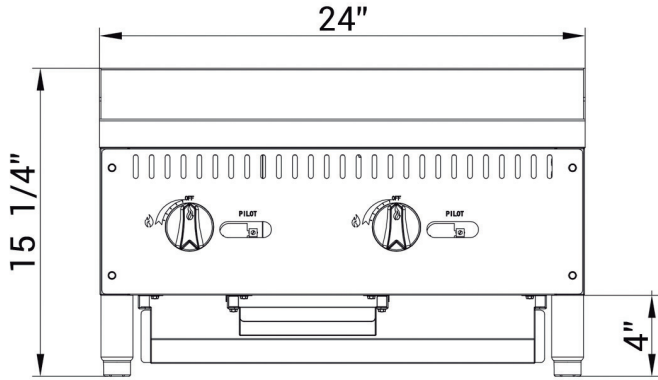

DCGM24

GAS SOURCE	NG/Propane
WORK AREA	23.86" x 20.50"
BURNER	2 count
SINGLE BURNER	30000 BTU/H
COMBINED	60000 BTU/H
GAS PRESSURE	NG: 4 "WC Propane: 10 "WC
NOZZEL	NG: 37# Propane: 51#
CONTAINER FITMENT	250

Top View

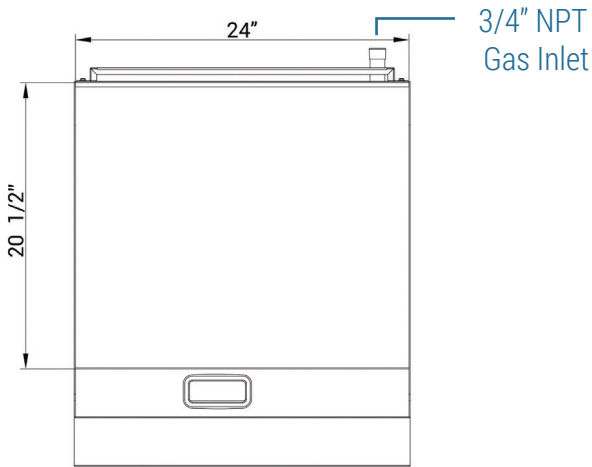

Side View

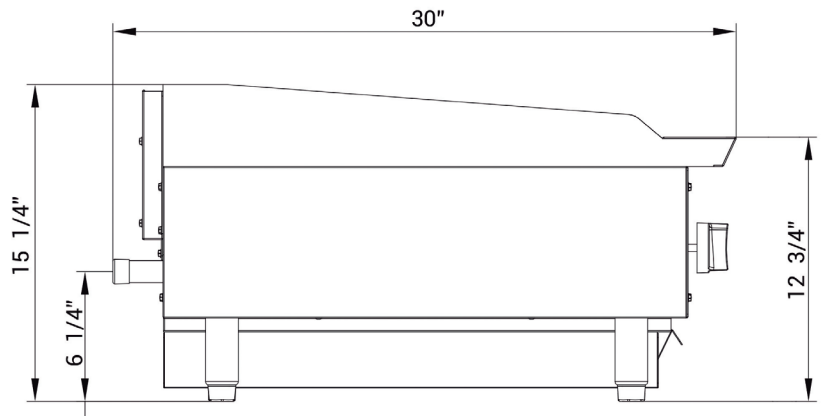

Model	Packaging Dimensions (inches)			Net Weight (lbs)	Ship Weight (lbs)
	W	D	H		
DCGM24	26 1/8"	32 5/8"	20 1/2"	176.37	198.42



Los Angeles | San Francisco | Dallas
Houston | Florida | Chicago | New Jersey

1-800-931-8628

@ info@dukersusa.com

www.DukersUSA.com