

=80" 2032MM

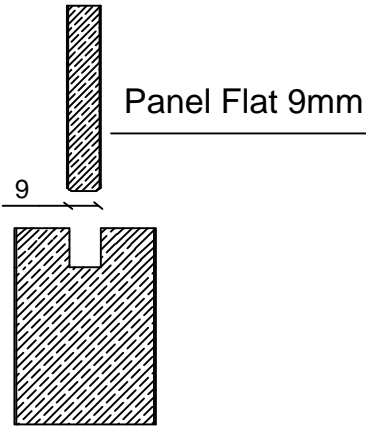
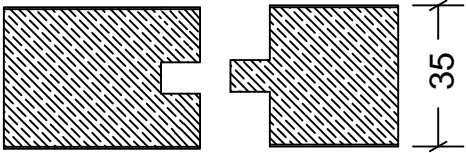
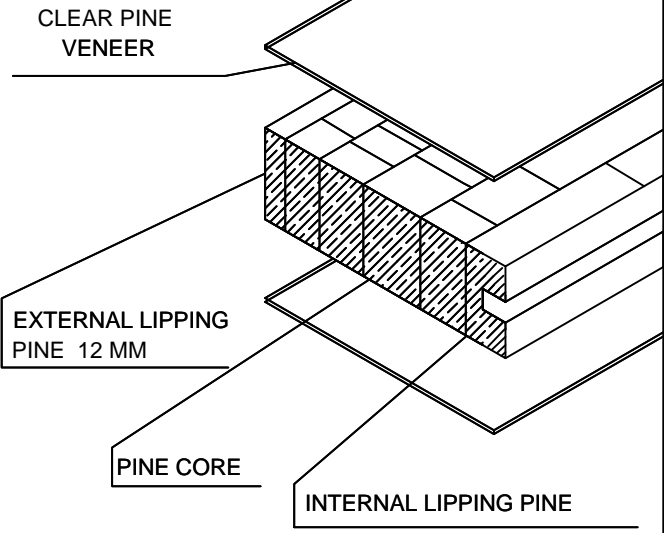

111	692	111	36"	914mm
111	591	111	32"	813mm
111	540	111	30"	762mm
111	489	111	28"	711mm
111	388	111	24"	610mm
111	286	111	20"	508mm
111	235	111	18"	457mm

DESIGNER	EDIMAR
CUSTOMER	SUMMIT
COD	RF 705
THICK	35MM
MODEL	5P SHAKER
DATE	24/04/2017
PLEASE CONFIRM	

RF#705 - SHAKER - PRIMED

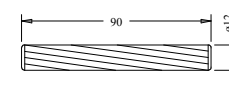
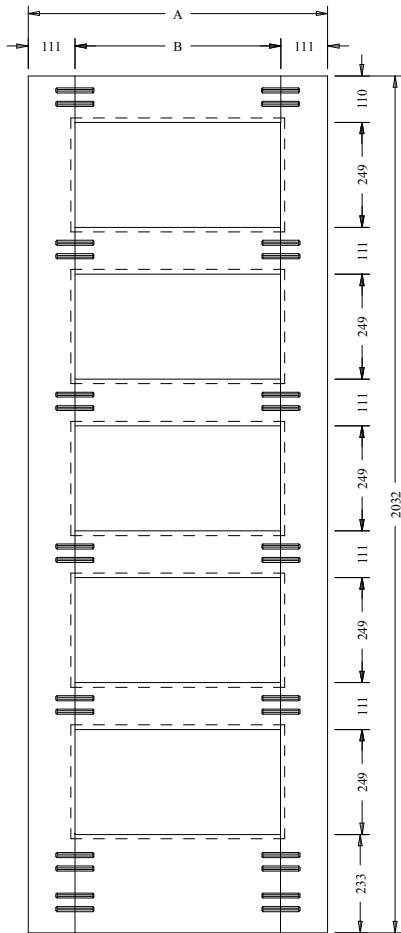

Cavilha

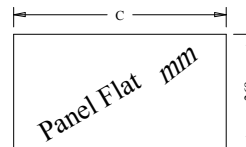

Montante

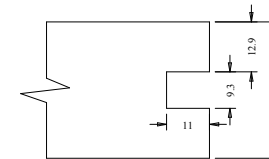
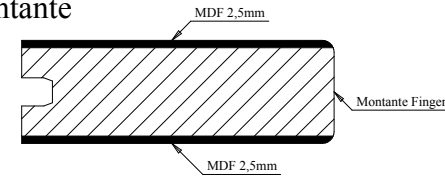

Moldura P-8mm

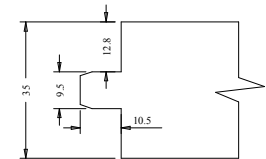

Respiga P-8mm

A	B	C
36"(914.4)	692.4	712
34"(863.6)	641.6	662
32"(812.8)	590.8	611
30"(762)	540.0	560
28"(711.2)	489.2	509
26"(660.4)	438.4	458
24"(609.6)	387.6	408
22"(558.8)	336.8	357
20"(508)	286.0	306
18"(457.2)	235.2	255
16"(406.4)	184.4	204

Modelo Shaker

Título: RF#705 - 80" x 16" A 36" X 35mm - Primed - Shaker				Escala	(1/1.11)
				Nº Desenho	967-000
SQUARE ONE BUILDING PRODUCTS	Cliente	ROHDEN - USA		Revisado Por	Renato Cavilia
	Desenhista	Renato Cavilia	Aprovação	Charles Agostini	
	Data	22/05/2012	Data	22/05/2012	Data Revisão