

Metal Storage CABINET

Instructions Manual



METALTIGER

www.metal-cabinets.com

THANK YOU FOR CHOOSING METALTIGER!

Your new **Metal Storage Cabinet** has arrived and it will make your life so much easier. That's why we put so much effort into designing it to perfectly **fit your needs.**

But first things first, we need to install it!
When we say 'we', we mean we're going to guide you, step by step.

We created this instructions manual so that you won't feel overwhelmed and get your new **METALTIGER** cabinet up and ready to use in no time!

We also know that sometimes things just don't seem to fit, so don't hesitate to drop us a line at **contact@metal-cabinets.com** if you have questions or need help!

Anyways, this METALTIGER cabinet CAN'T WAIT TO BE OF SERVICE so let's **assemble it!**

MISSING A PART? DON'T WORRY, WE GOT YOUR BACK!

Compare the sketch on the next page with your package. Are all the pieces there?

However, sometimes errors happen, so if anything is missing, just send us an email and we will make sure to fix it!

www.metal-cabinets.com

HERE IS WHAT YOUR METAL STORAGE CABINET PACKAGE SHOULD CONTAIN

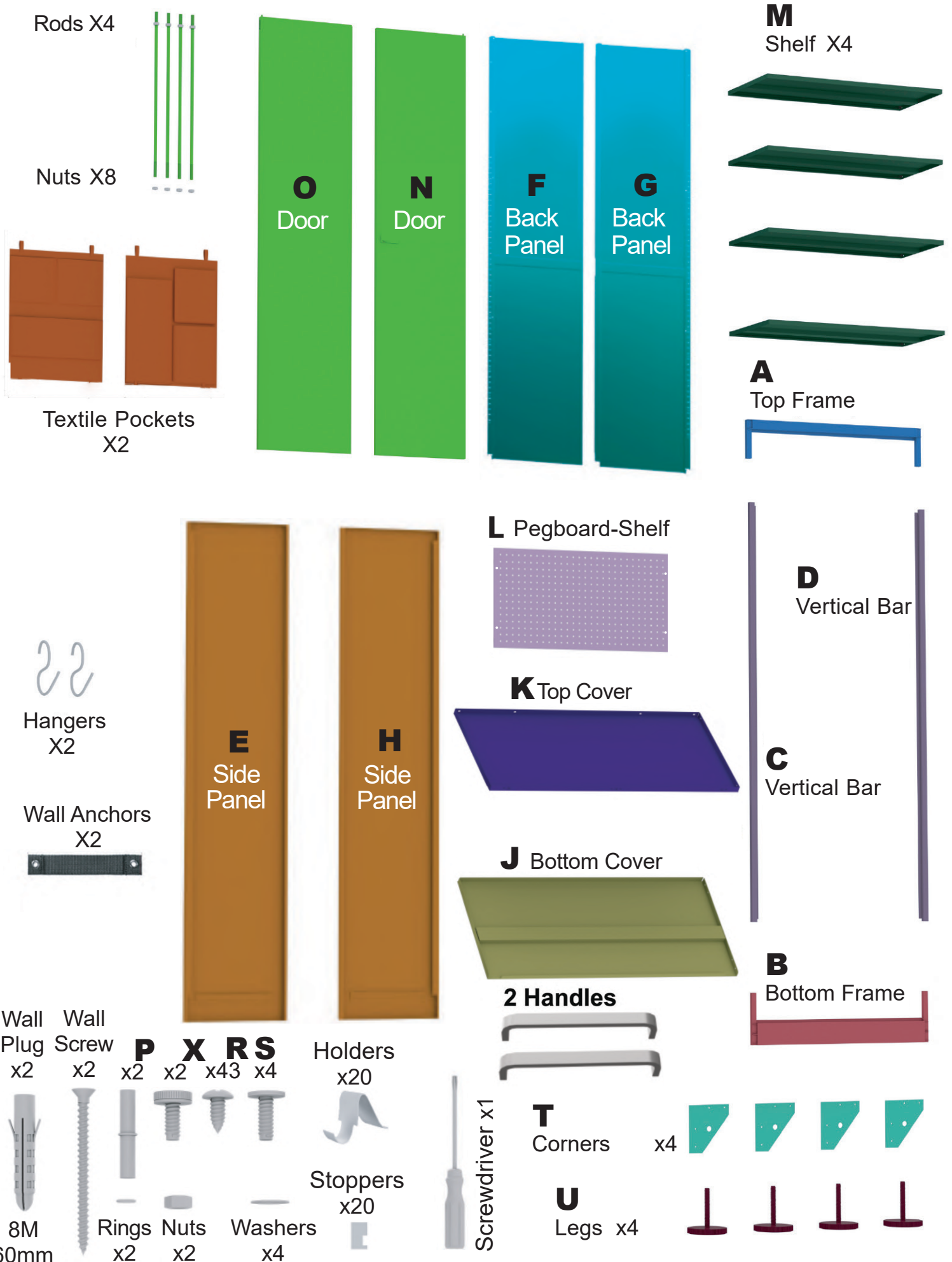



Before you start, here are a few quick pointers:

The installation requires **Two People**, so call a friend to join the fun! For more stability, it's best to anchor the metal wardrobe to the wall. In this case, along with the items provided you will also need a **Level, Percussion Drill & Hammer**

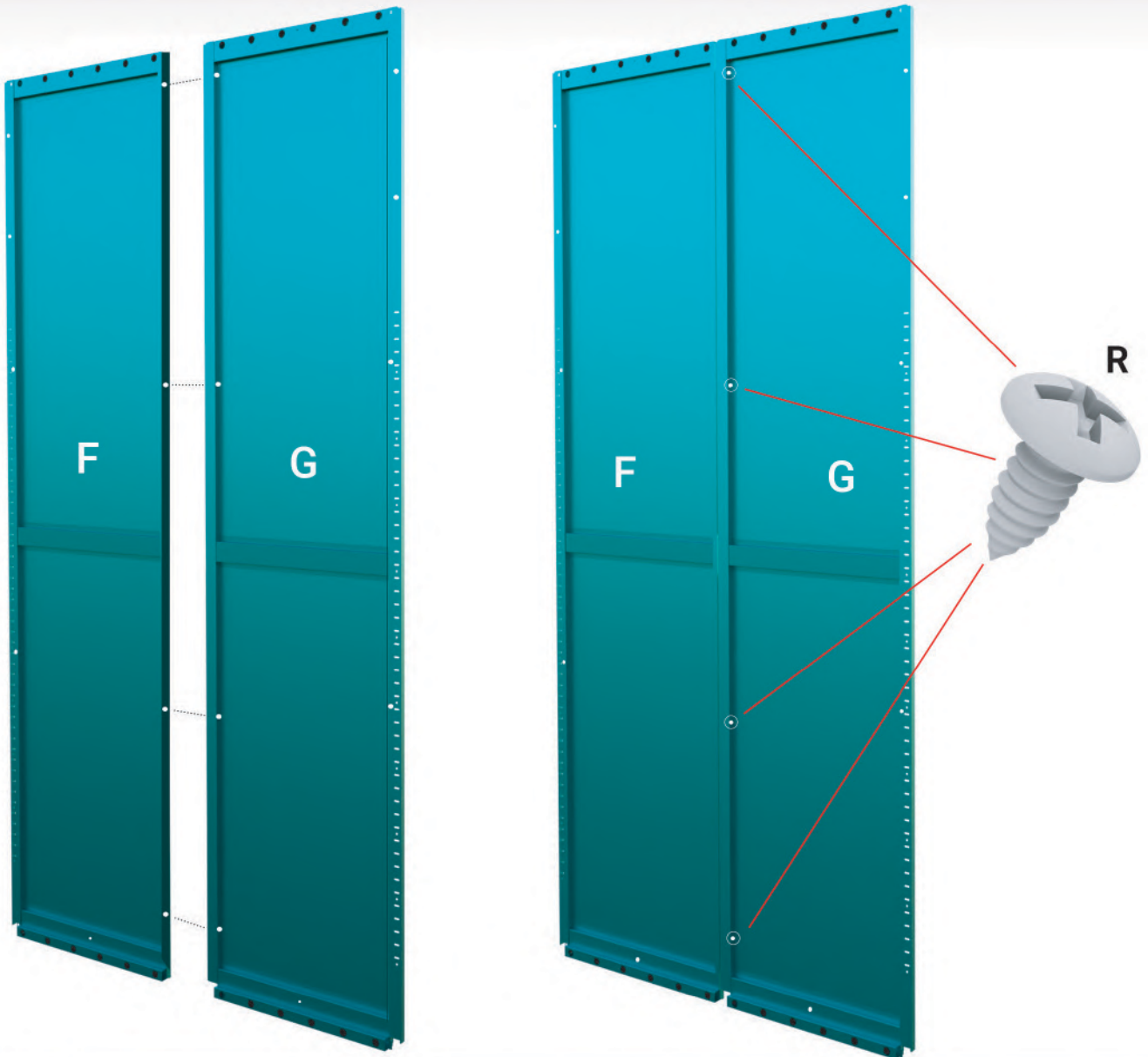

STEP 1

Let's start with the back of the cabinet.

Take Back Panel pieces F & G.

Place them on the floor .

The frame with rectangular holes must be pointing upwards.

Overlap & align the holes of the interior frames.

Fasten in place using 4 R screws

(like shown in the picture)



STEP 2

Take Side Panel E. Place as shown in the picture.

Overlap the back panel's frame over the Side Panel E outer frame.

Align the holes.

Fasten in place using 3 R screws.
(like shown in the picture).

Repeat for Side Panel H.

R



E

H

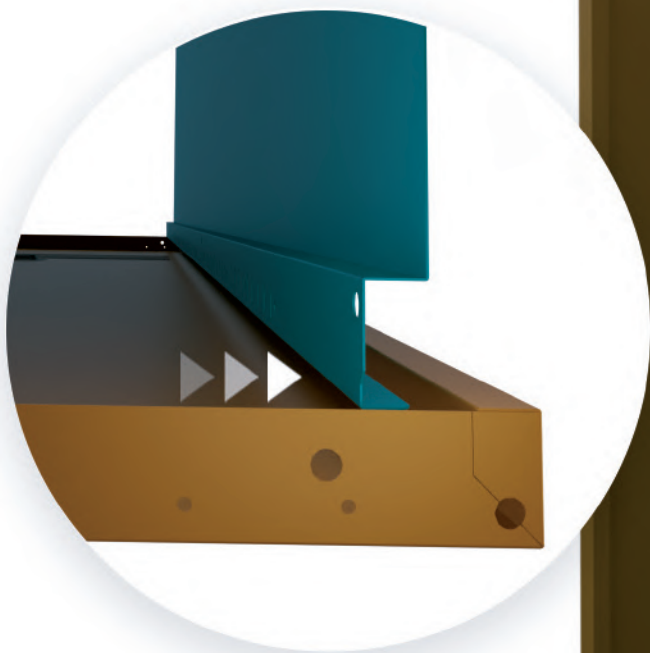

THIS
SIDE
DOWN



STEP 3

Take Top frame part A, Bottom frame part B & Vertical bars C and D.

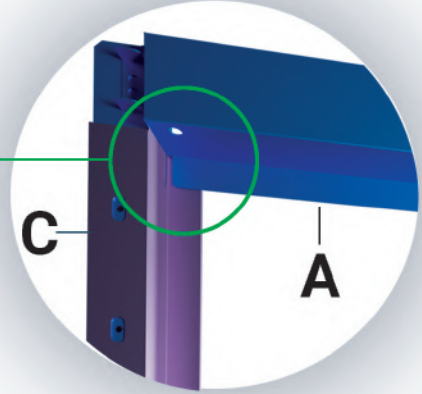
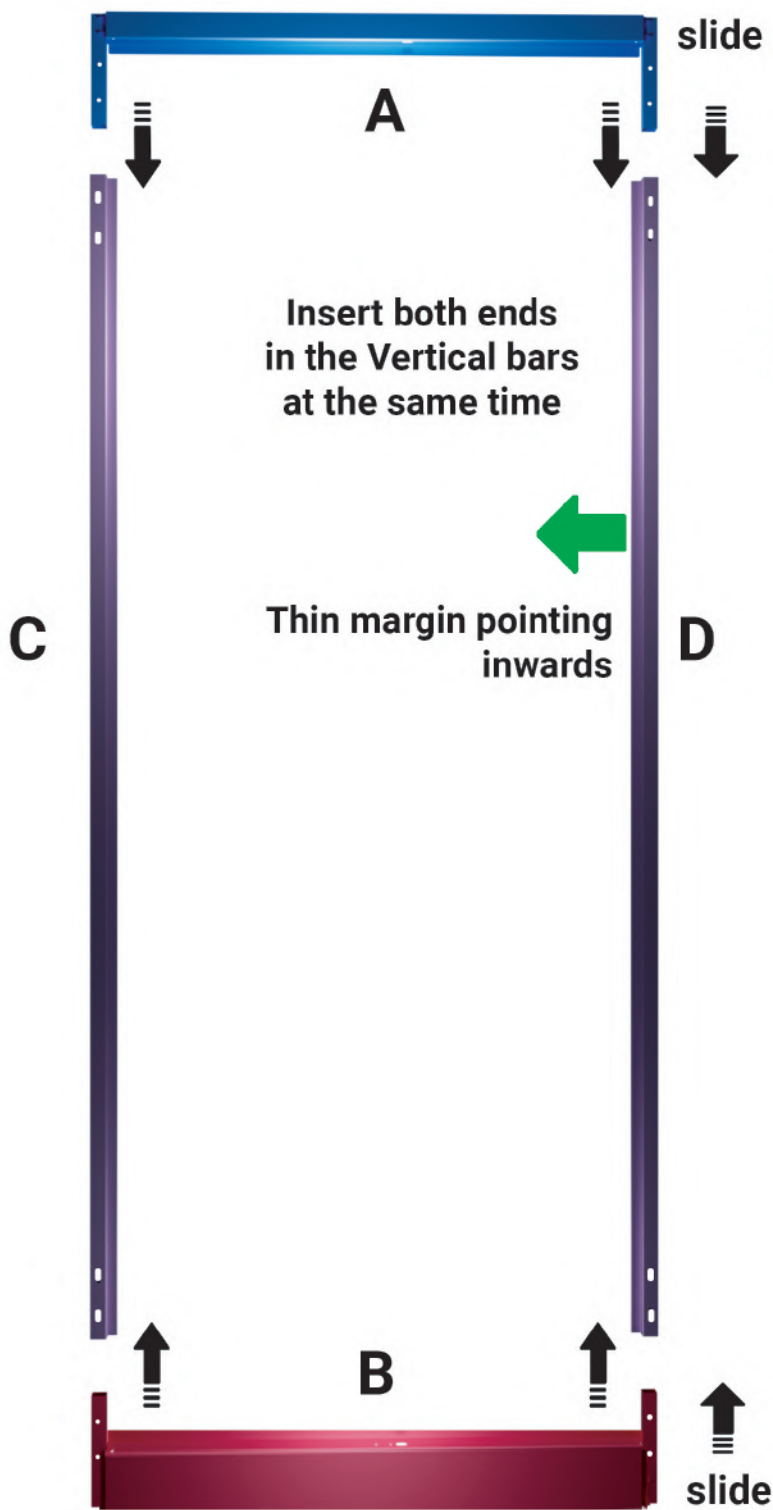

Make sure that the thin margin of the Top Frame A is ABOVE the thin margins of C and D

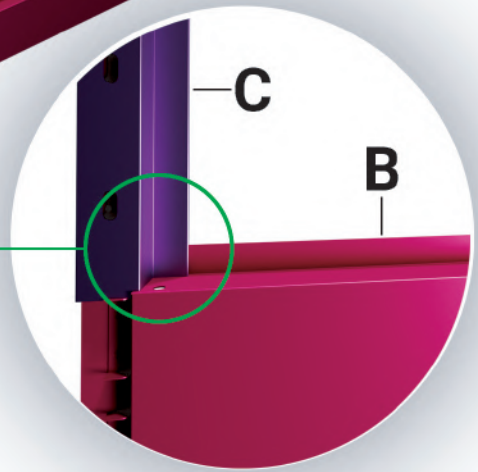
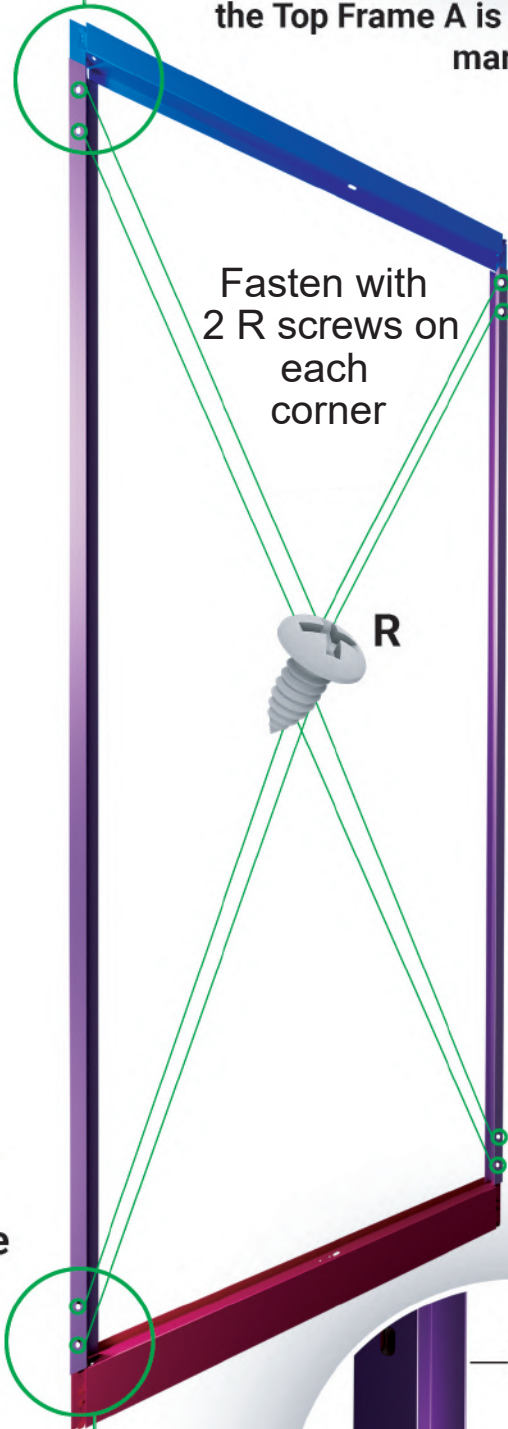

Make sure that the thin margin of the Bottom Frame B is BELOW the thin margins of C and D

STEP 4

Insert the frame through the cabinet's walls slightly inclined.
The side with rectangular holes must point inwards the cabinet.
Align it with the cabinet's wall frames.

Fix it in place pulling the frame towards you until it securely enters the edges of the frame.

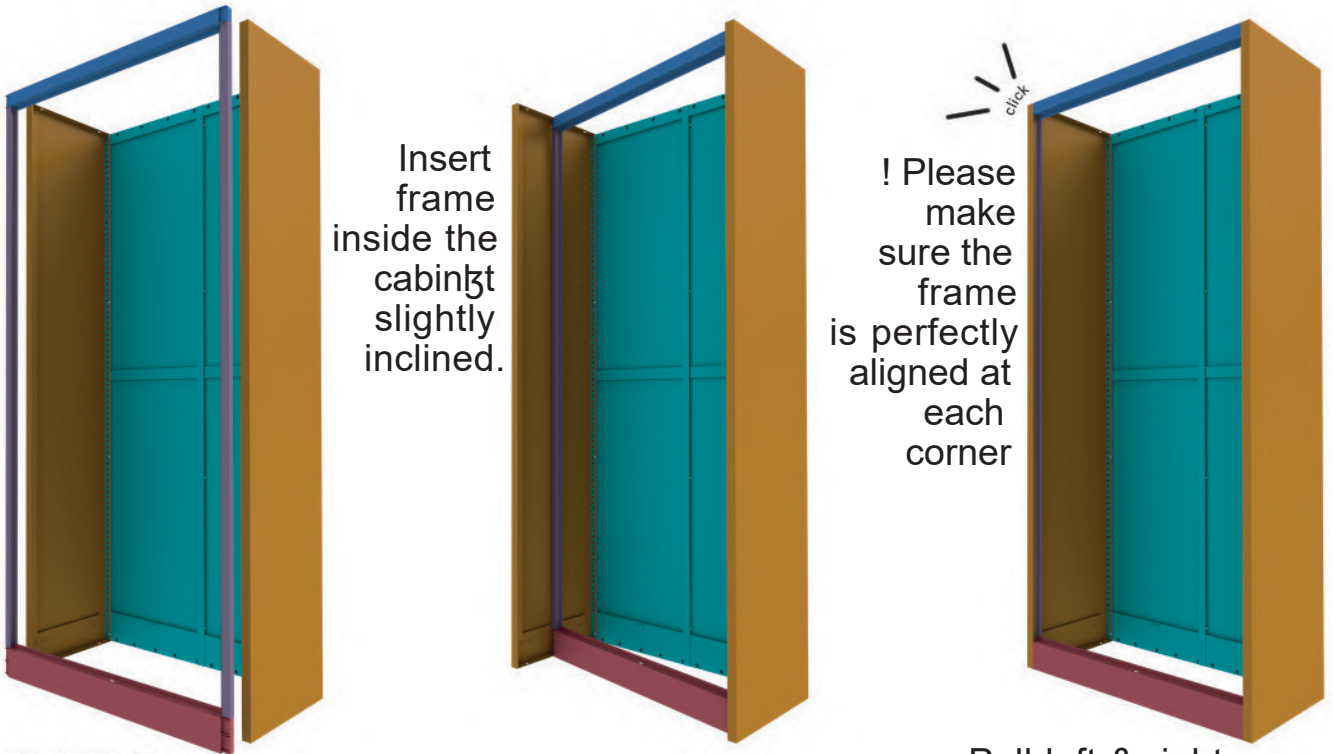

STEP 5

Pull left & right parts at the same time.

Take corner T.

Fasten it on the bottom of the cabinet, in one corner (like shown in the picture)
Fix using 4 R screws for each. Repeat for the other 3 corners.

Take legs U. Screw in the middle hole of each corner.

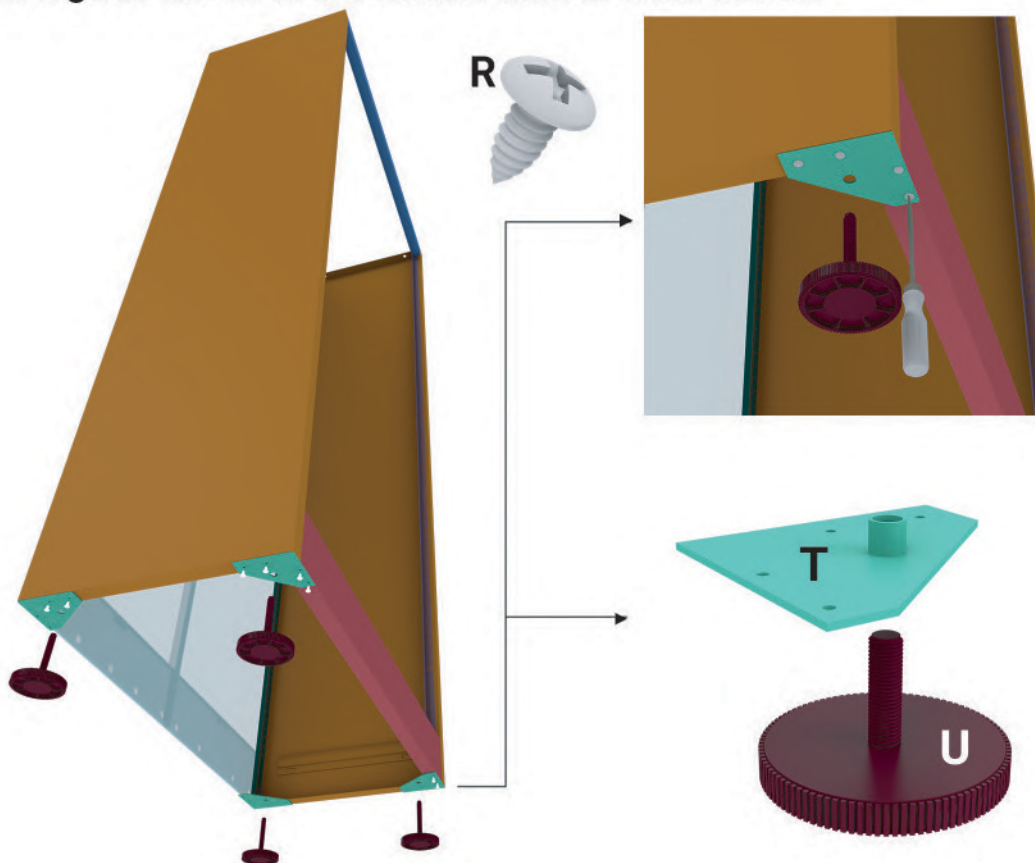

STEP 6

Take Top Cover K.

The 3 H Holes must face to the front of the cabinet.

Insert it through the cabinet slightly inclined.

Push it until well fixed.

Fasten in place using 7 R screws
3 in the back & 4 in the front.

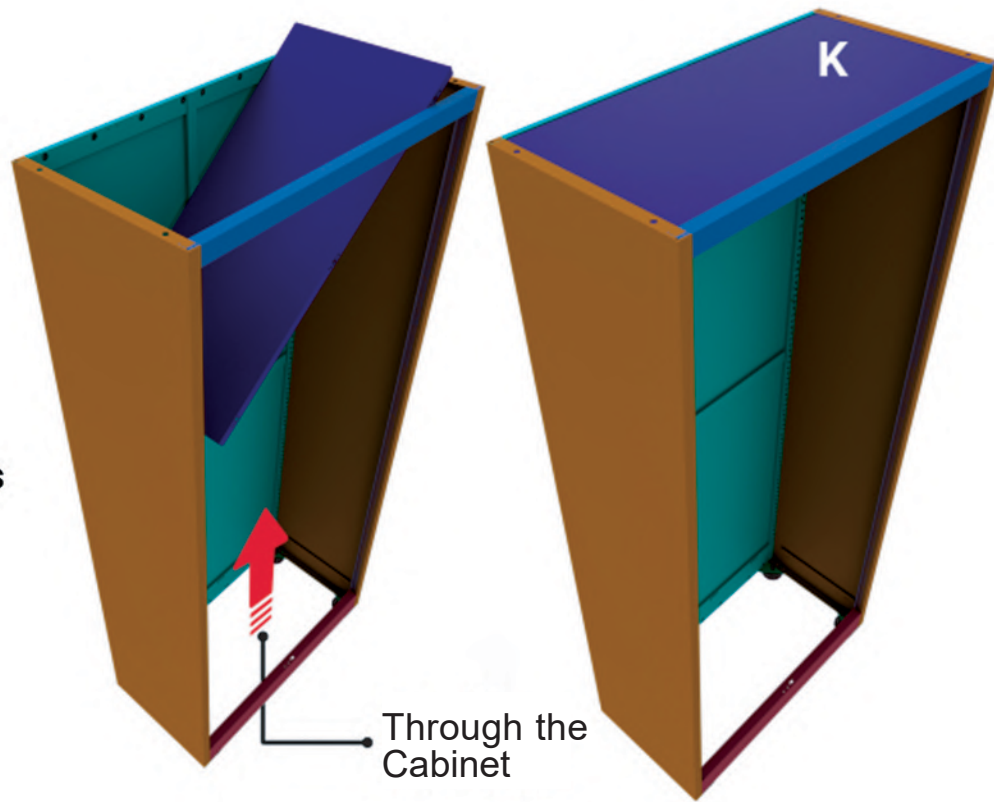

**BACK
SIDE**

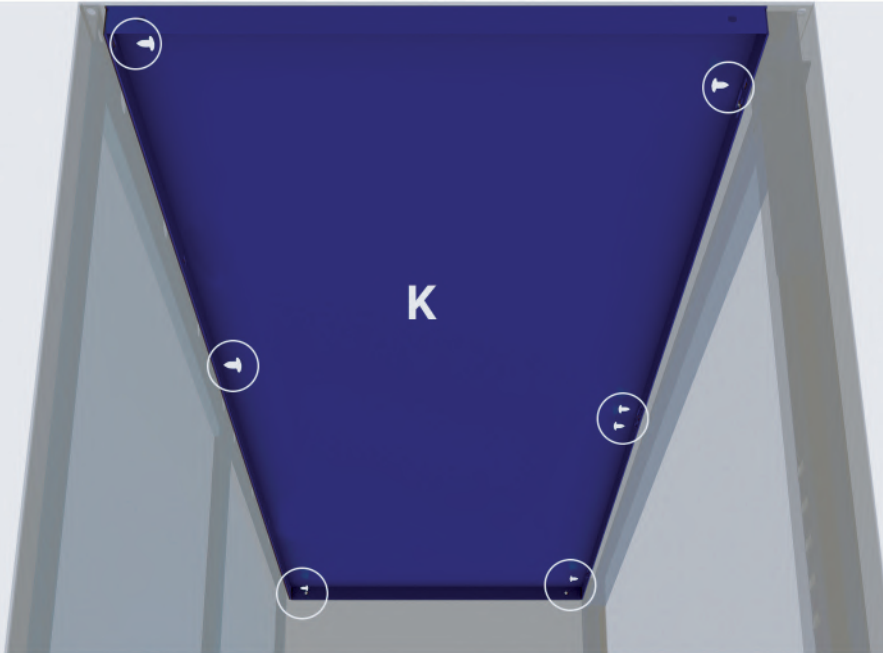

**FRONT
SIDE**

STEP 7

Push the legs of the H Hole inside using the tip of the screwdriver.

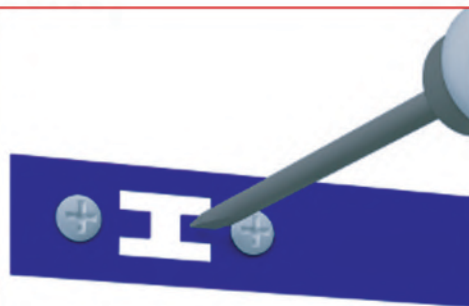
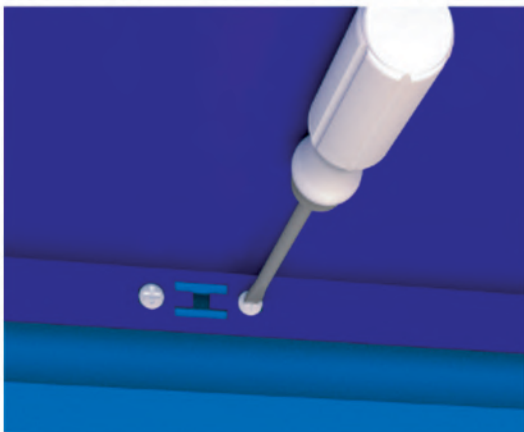

STEP 8

Take Bottom Cover J.

Insert it through the cabinet slightly inclined.

The cutted frame must face the front of the cabinet.

Push it all the way down until well fixed in the side clamps.

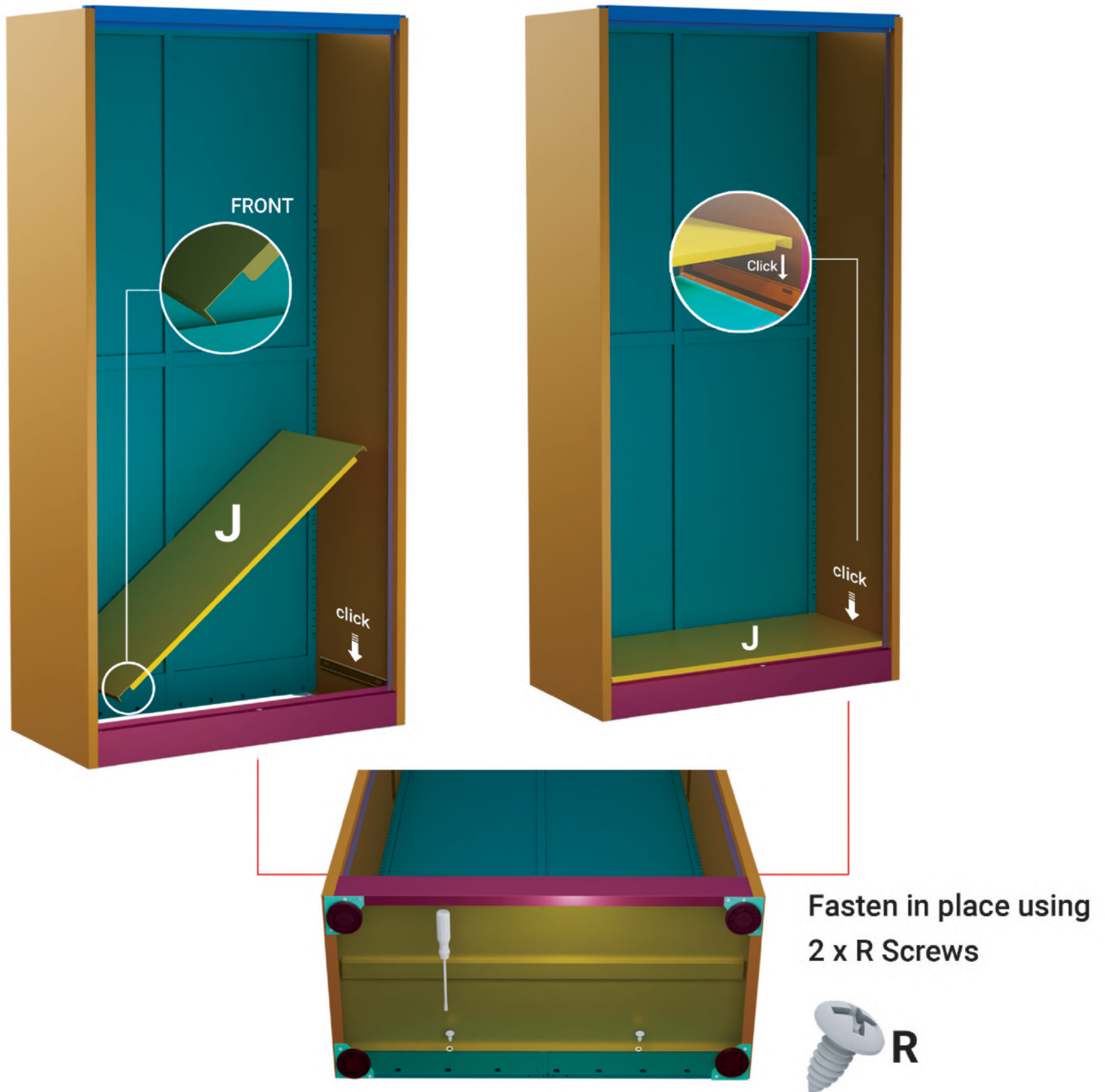

STEP 9

Check if the metal cabinet is standing in balance on the floor.

If not, now it's the moment to adjust the legs so it stays perfectly straight.

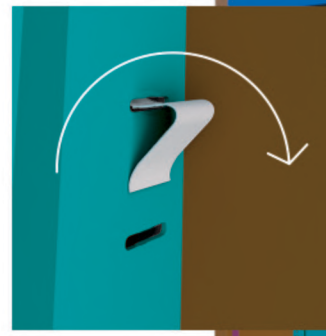
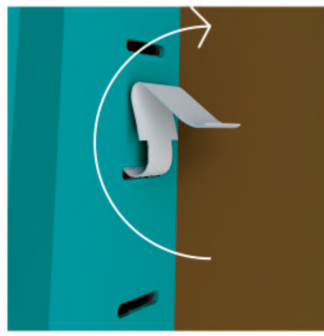
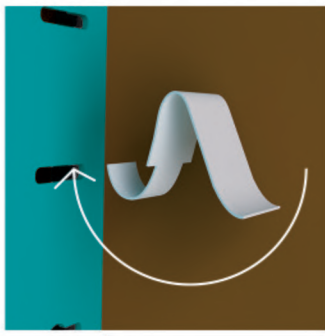

Holders

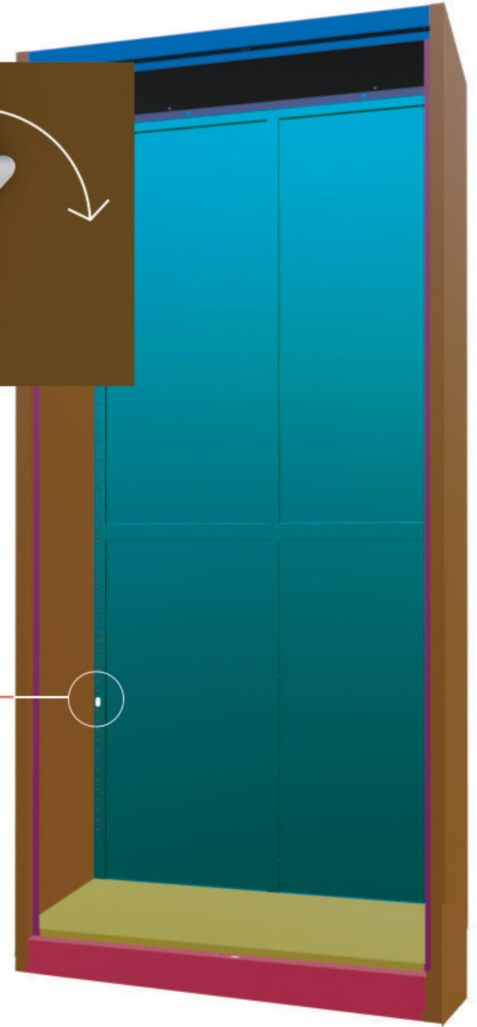

STEP 10

Choose where you want to mount the first shelf.

Insert 4 holders in the frame's holes,
1 for each corner.

Observation: Make sure to leave room for installing the Pegboard on the upper part of the cabinet.
The Pegboard has designated rivets on the back panel (please see next step).

- Insert the shelf slightly obliquely.
- Place the shelf on the 4 holders.
- Repeat for the other 3 shelves.

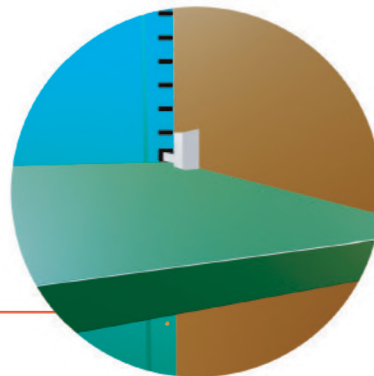
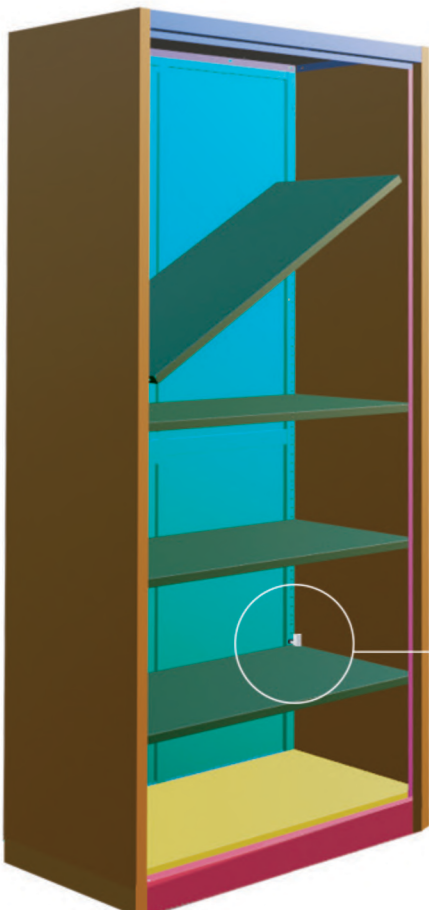

Optional: For better stability of the shelves, please use the plastic stoppers.

STEP 11A

Take the Pegboard-Shelf L.

Place it at the top of the back panel.

Align it with the holes of the back panel's side frames.



Fasten in place using 4 S screws (as shown in the picture).

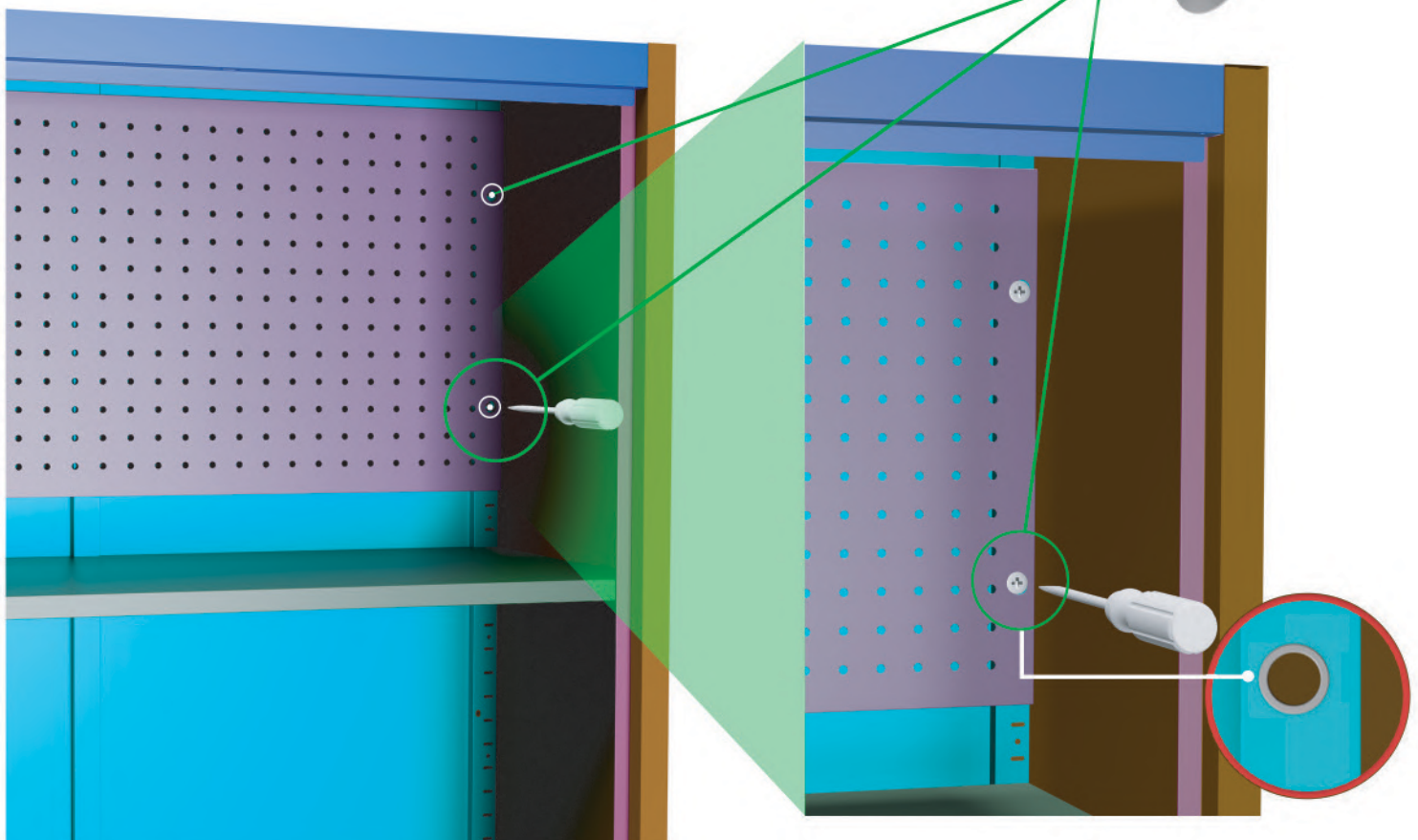

STEP 10B

If desired, our pegboard can also be used as a shelf. Simply add four additional shelf holders where needed, then place the **Pegboard-Shelf** in the cabinet horizontally, same as the other regular shelves.

The **Pegboard-Shelf** can support up to 110 pounds of weight.

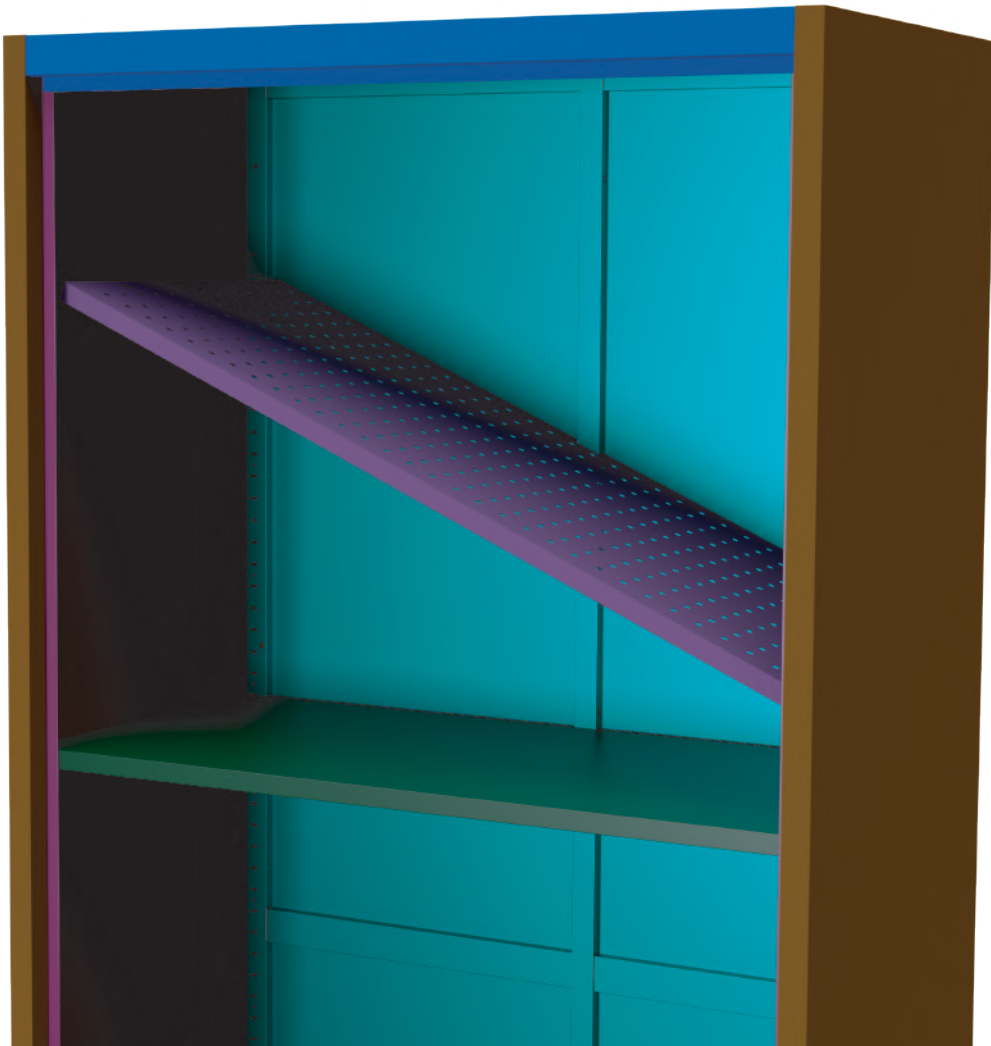

STEP 10C

A third installation choice is available for our Pegboard.

Separate from the cabinet, it can be wall-mounted.

If you decide to do this, make sure the hardware you supply and use is appropriate for the type of wall you have.

STEP 12

Take 1 Bolt P & insert a plastic ring on it.

Insert the bolt at the bottom frame of the cabinet (like shown in the picture below).

Take door N.

Place the door with the bottom hole in the bolt.

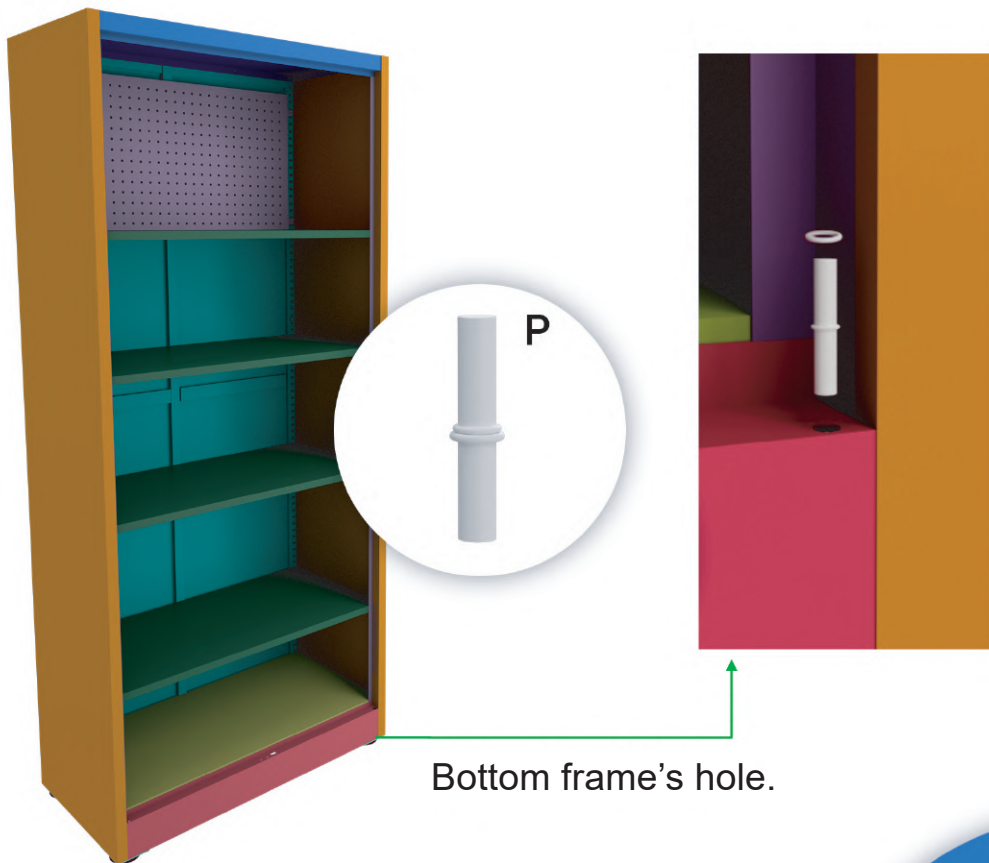

Bottom frame's hole.

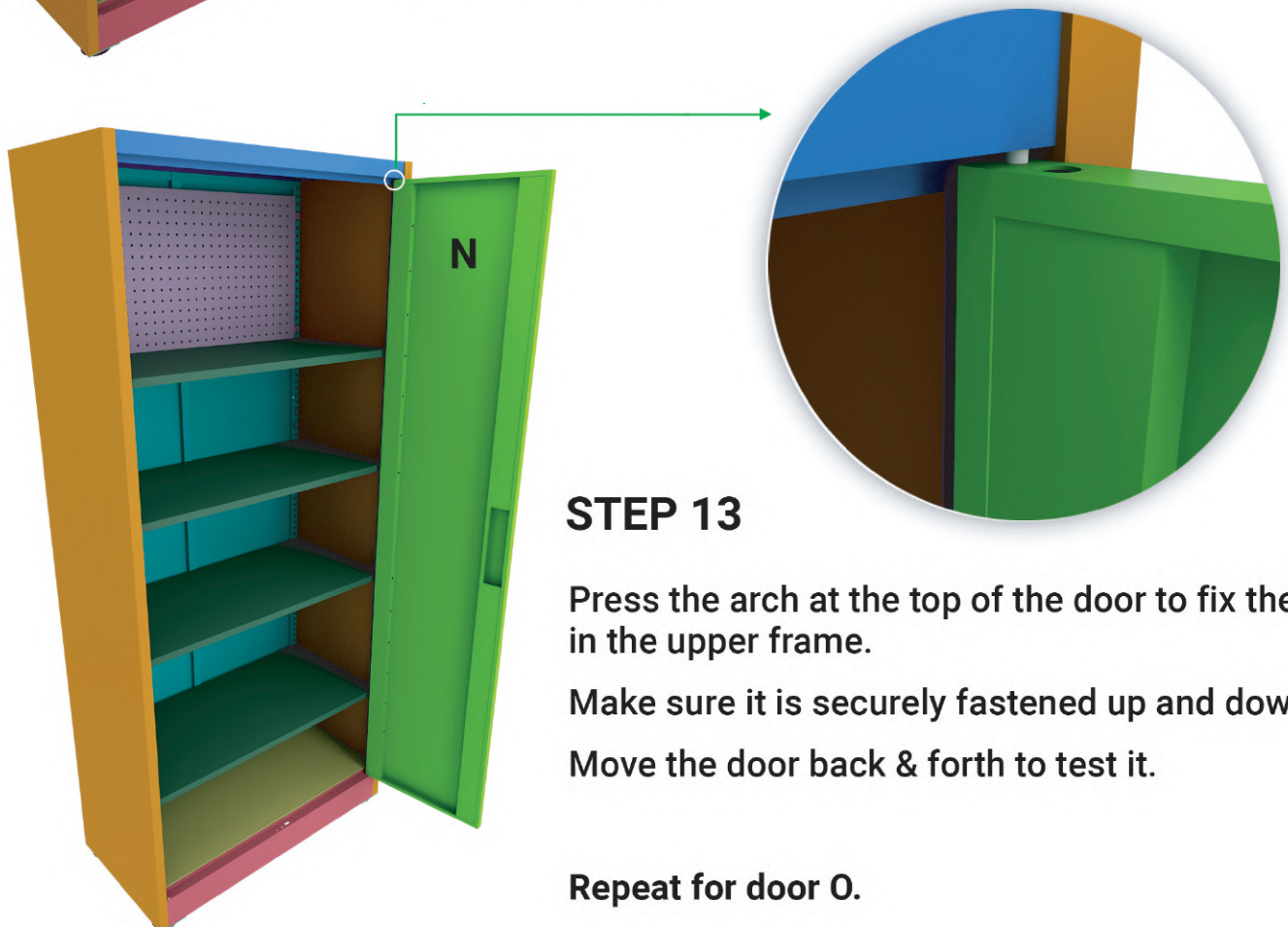

STEP 13

Press the arch at the top of the door to fix the door in the upper frame.

Make sure it is securely fastened up and down.

Move the door back & forth to test it.

Repeat for door O.

STEP 14

Remove the screws from the two handles.

Align the handle holes with the holes in the door before using the screwdriver to secure the screws through the back of the door, as shown in the illustration.

Repeat for the second handle.

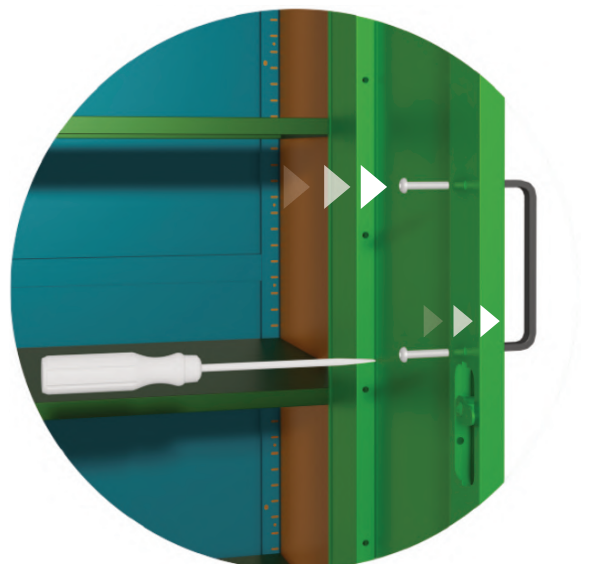



STEP 15

Take 2 rods & insert one nut on every end of the rods.

Insert 1 rod through the 2 textile hangers on the top of the pockets.

Repeat for the other rods.

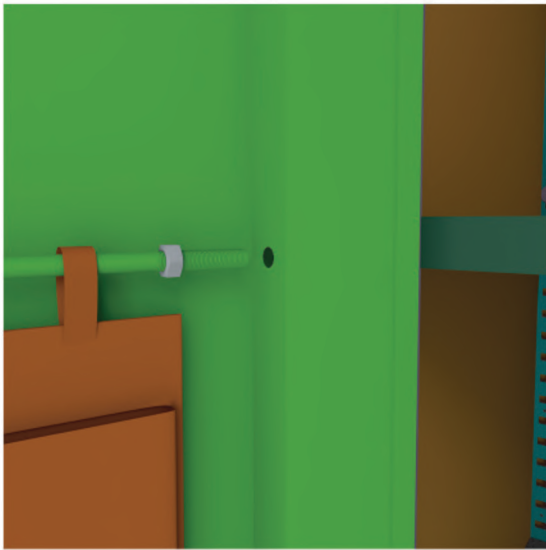

STEP 16

Put the ends of the rods through the side holes of the door.

Screw the nuts as close to the door frame as possible.

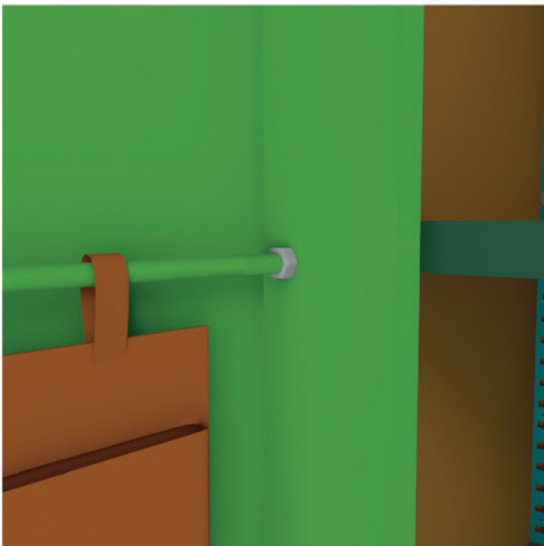

STEP 17

Take 1 rod. Insert 1 nut on every end of the rod.

Place on top of the door and fix with the nuts.

Place 2 hangers on the rod.

Repeat for the other door.

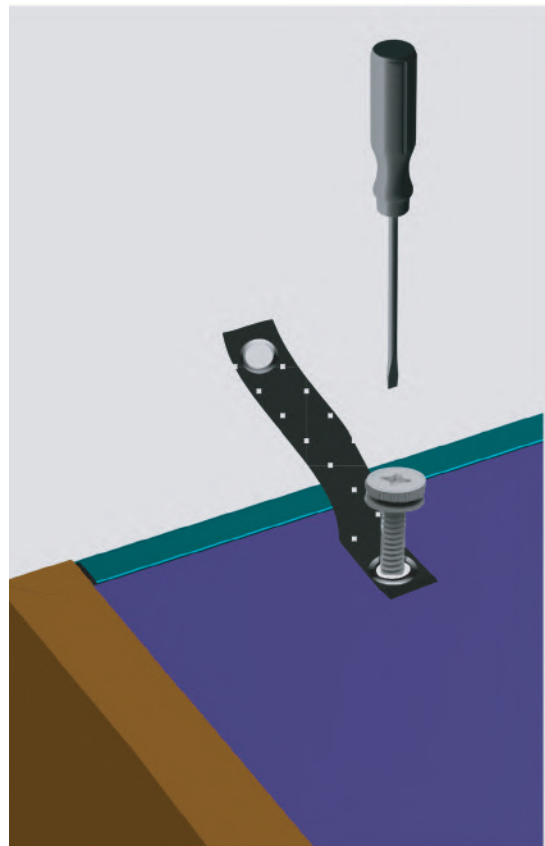

STEP 18 FIX THE CABINET TO THE WALL

Align the holes of the wall anchors with the holes on the top cover of the cabinet.

Using the X screws fasten the 2 anchors to the top of the cabinet.

STEP 19

Push the metal cabinet against the wall. Mark the places on the wall where you are going to drill.

Take the Percussion Drill. Drill holes in the marked places.

Take wall plugs & insert in the drilled holes using a hammer.

Fix the wall anchors to the wall using 1 screw for each.

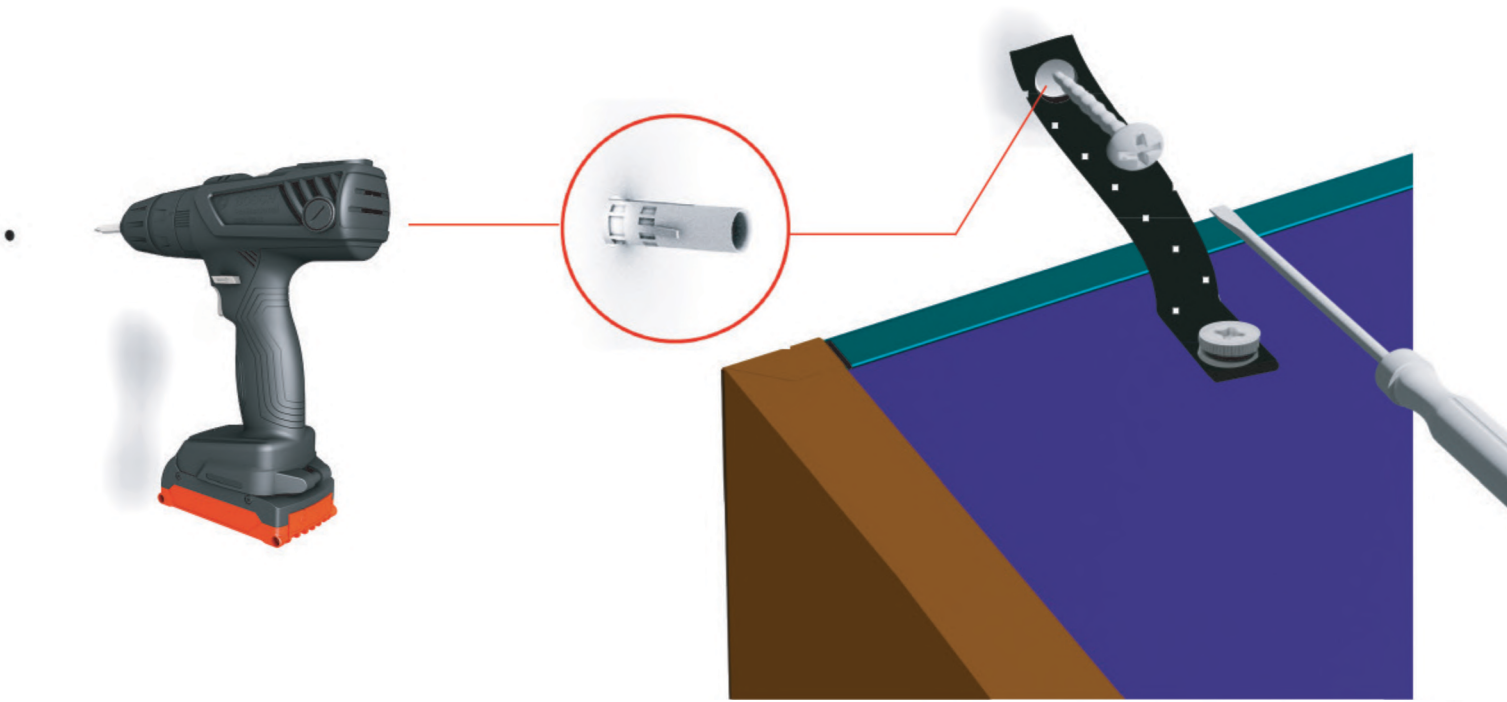

Congratulations!

Your metal cabinet is ready to use!

We use extremely safe packaging in an effort to guarantee that the product reaches you in the best possible condition.

However, sometimes events are beyond our control, and some components may come loose during shipping. Here are some suggestions to quickly and easily resolve this:



In case the locking system is not working properly:

1. Please make sure your metal cabinet is perfectly upright & in perfect balance.

Use a level and adjust the position of the legs.

2. Please check the top rod of the door which should be held in place by a small white plastic

If the plastic is missing, please take out the rod through the top hole and fix it in place with a new plastic from the spare parts bag.

Repeat for the bottom rod if needed.

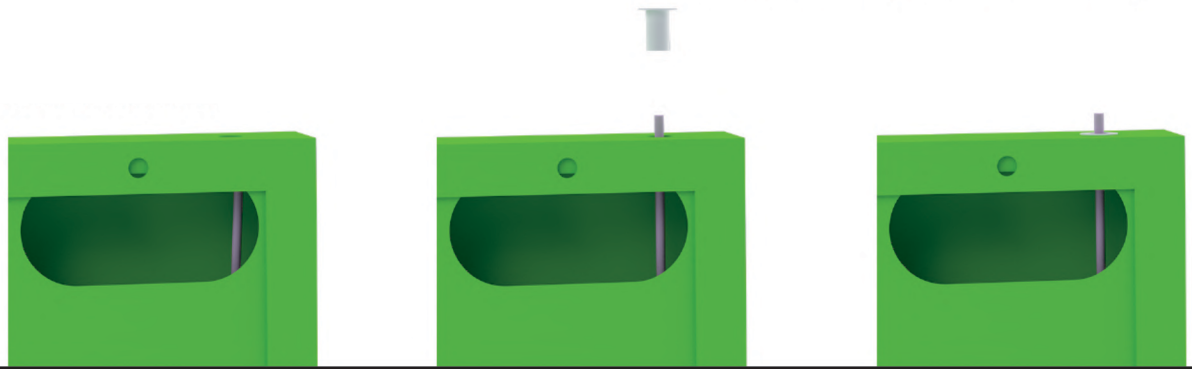

How to install the spring rod into the door:

Invert the spring rod through the big hole.

Twist the end to point out.

Insert it through the inside hole.

Use a sharp object to guide the spring rod through the smaller hole. That's it!



METAL**TIGER**

www.metal-cabinets.com

THANK YOU FOR BEING PART OF OUR STORY

Don't forget, we're always happy to hear from you. If you have any issue or just want to say hello, don't hesitate to write.

contact@metal-cabinets.com

IF YOUR METAL CABINET ALSO HAS A DIGITAL LOCK,
MECHANICAL COMBINATION LOCK OR FINGERPRINT
LOCK YOU CAN FIND ITS INSTRUCTIONS HERE

DIGITAL LOCK

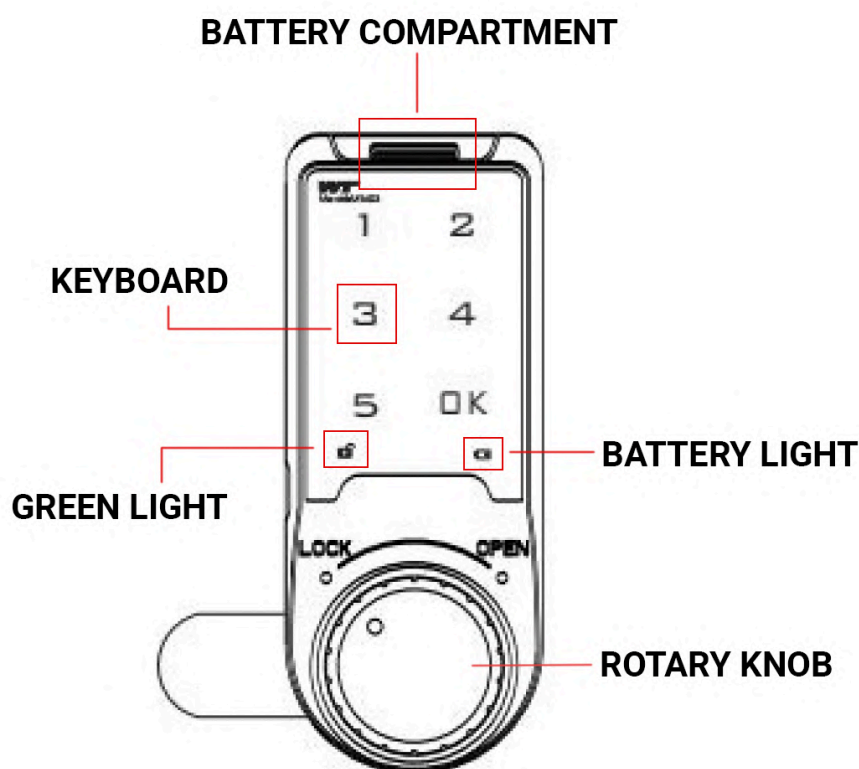

USER MANUAL

1. HOW TO USE:

The lock comes with a factory user password "1234" and a factory administrator password "4321".



1.1 OPEN:

Enter the password 1234 and press OK. You should hear a long tone and see a green light. Turn the knob to the right to open the door.

! Turn the knob to the OPEN position within 3 seconds to unlock the lock.

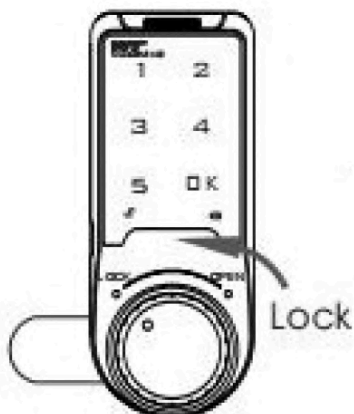

1.2 LOCKED:

Safely close the door and rotate the knob to the left. Door should be locked.

2. SETTING A NEW USER PASSWORD

Start with the digital lock open (make sure the knob is turned to the right).

Enter the user password once again and press OK.

After that, long press the OK key until you hear a long tone & the green light starts flashing 

Enter the new password and press OK.

After the long tone, the new password is set successfully.

Once the new password is set successfully, the original password is invalid. Please remember your password and keep it safe.

If you forget your password, you can use the admin password to unlock.

3. SETTING A NEW ADMIN PASSWORD

**This step is optional*

Start with the digital lock in the open position.

(Make sure the knob is turned to the right).

Enter the admin password and press OK. After that, long press the OK key until you hear a long tone and the green light starts flashing.

Enter the new password and press OK. After the long tone, the new password is set successfully.

!!! IMPORTANT

If you choose to change your admin password, please remember your password and keep it safe.

In case you forget the user password, the new admin password must be used to reset it.

When you enter the admin password, the user password becomes 1234 again.

NOTE!

Your password can be 4-15 digits long.

The user password and the administrator password can not be the same.

serial number

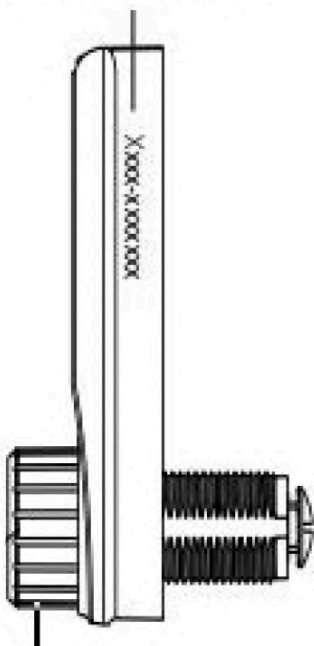

rotary knob

4. SPECIAL FUNCTIONS

4.1 Forget password - DECODE

If you ever forget your user password, use your administrator password to unlock.

If you forgot both passwords and can't open the lock anymore, please send us the serial number printed on the right side of the lock: contact@metal-cabinets.com