

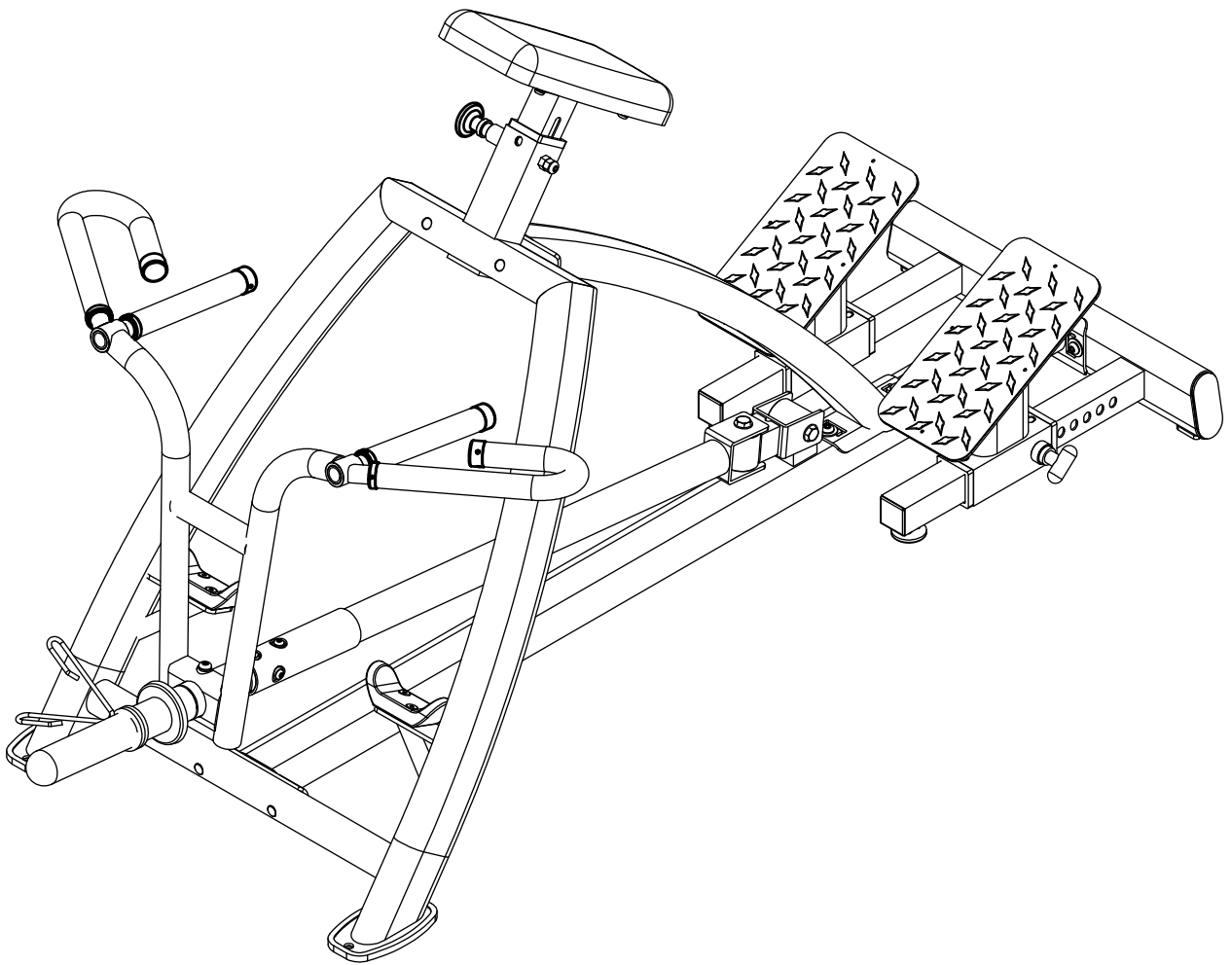

PLTR.6



Assembly & Instructions
OWNER'S & MANUAL

HARDWARE

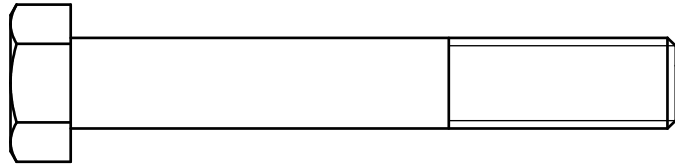
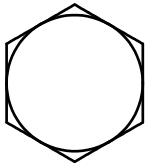

A1. M12X80 HEX HEAD SCREW...2PCS

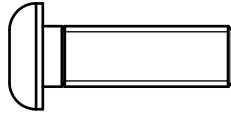
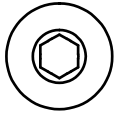

A2. M8X25 ALLEN SCREW...4PCS

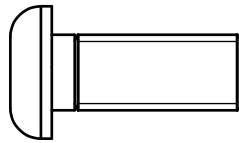
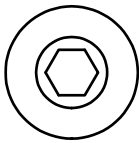

A3. M10X25 ALLEN SCREW(FULL THREAD)(Pre-installed...1PCS)...9PCS

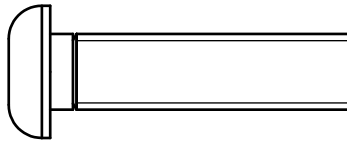
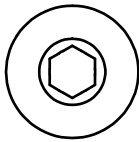

A4. M10X40 ALLEN SCREW(FULL THREAD)...2PCS

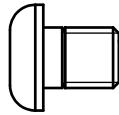
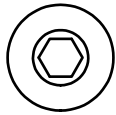

A5. M8X10 ALLEN SCREW(FULL THREAD)...4PCS

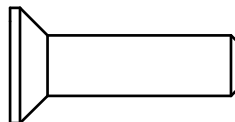
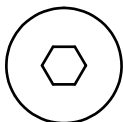

A6. M8X30L Conical inner six angle screw(Pre-installed)...4PCS



A10. M5X5 GRUB SCREW...(Pre-installed)16PCS

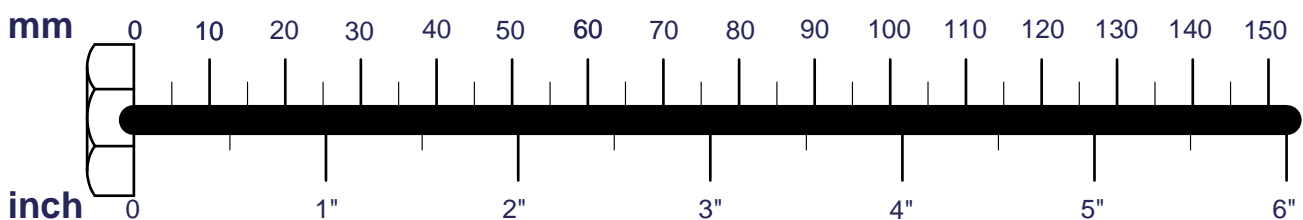

HARDWARE

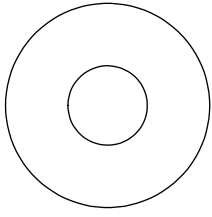

C1. M10 WASHER...4PCS

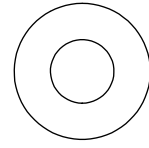

C2. M8 WASHER...4PCS

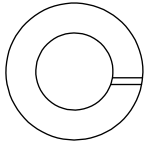

C3. M10 SPRING WASHER...2PCS

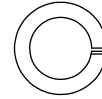

C4. M8 SPRING WASHER...4PCS

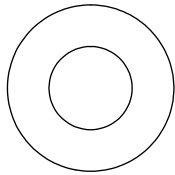

C5. M10 CURVED WASHER...6PCS

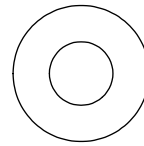

C6. M8 CURVED WASHER...4PCS

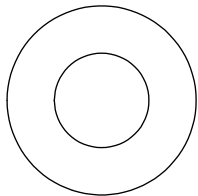

C7. M12 WASHER (Ø25)...4PCS

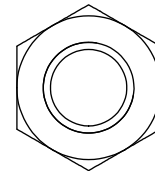

B3. M12 LOCK NUT...2PCS

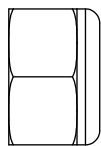
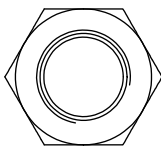

B1. M12 NYLON LOCK NUT...2PCS

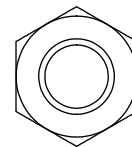
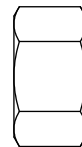

B2. M10 LOCK NUT...1PCS(Pre-installed)

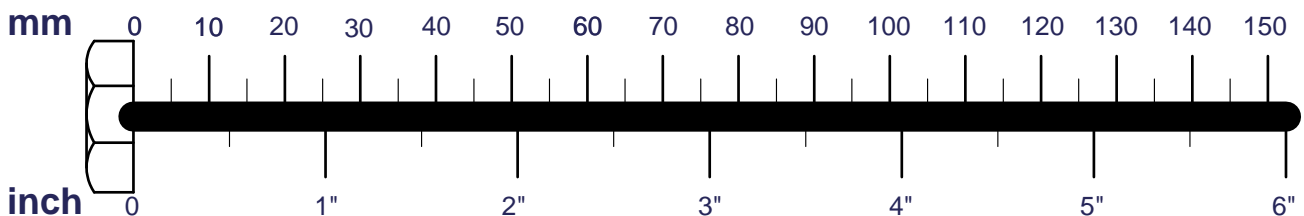

PLTR.6 PARTS

A [1PCS]

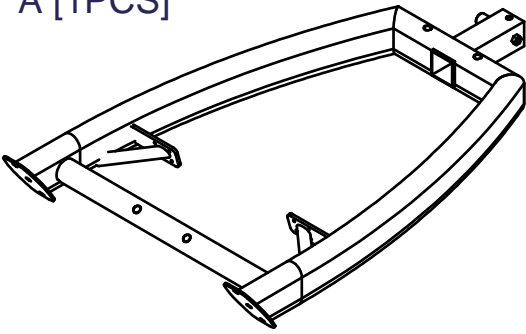

B [1PCS]

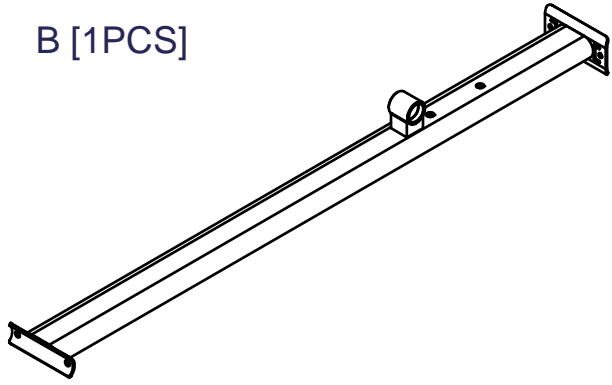

C [1PCS]

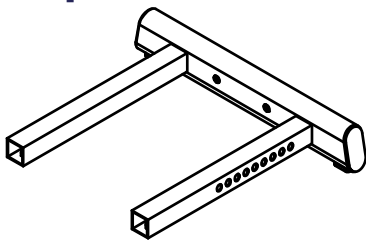

D [1PCS]

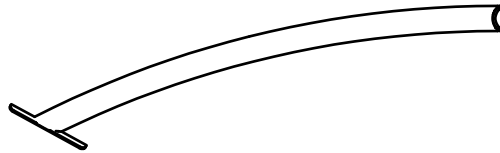

E [1PCS]

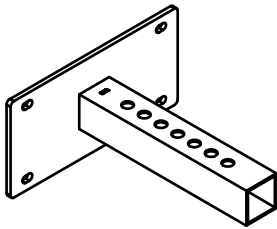

F [1PCS]

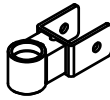

L [1PCS]

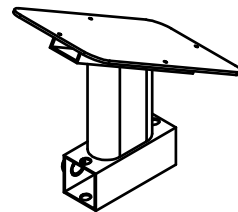

G [1PCS]

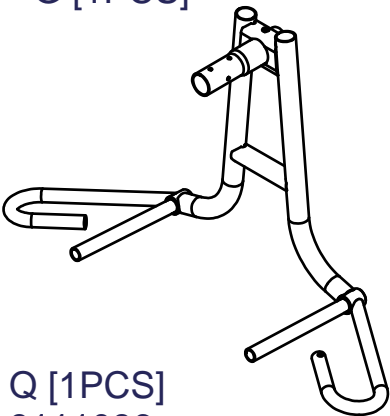

M [1PCS]

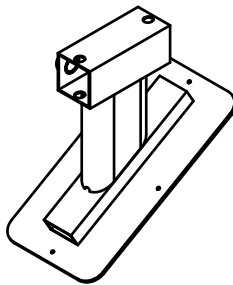

N [1PCS]

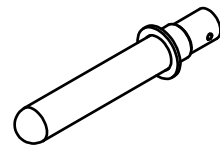

Q [1PCS]
9111086

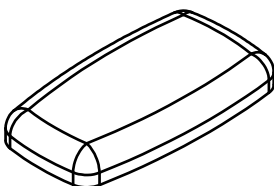

R [2PCS]
8360-184(Pre-installed)

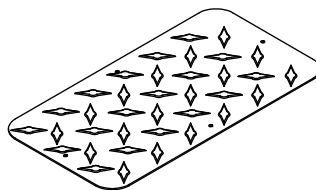

P [1PCS]

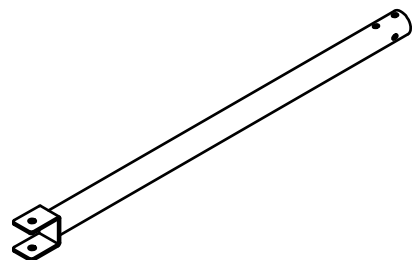

PLTR.6 PARTS

D1. Chrome collar (8130-254) (Pre-installed)-----	[4PCS]
D2. Flat head pop pin (8250-012) (Pre-installed)-----	[2PCS]
D3. Flat head pop pin (8250-065G) (Pre-installed)-----	[1PCS]
D4. Bearing (8510-003) (Pre-installed)-----	[4PCS]
D5. Chrome collar (8890-061) (Pre-installed)-----	[4PCS]
D6. Impregnated with handle (9162-147) (Pre-installed)-----	[2PCS]
D8. Impregnated with handle (9162-226) (Pre-installed)-----	[2PCS]
D9. End cap (9211-004)-----	[3PCS]
D10. Nylon bushing (9211-032)-----	[4PCS]
D11. Nylon bushing (9211-047)-----	[1PCS]
D12. End cap (9211-009)(Pre-installed) -----	[4PCS]
D14. Rubber dount (9214-045)-----	[2PCS]
D15. Rubber stop (9310-016)-----	[1PCS]
D16. Rubber insert (9310-076)-----	[2PCS]
D18. Copper sheath (8520-032) (Pre-installed)-----	[4PCS]
D19. Impregnated with handle (9162-134) (Pre-installed)-----	[1PCS]
D21. Block Rubber (9310-119) (pre-installed)-----	[2PCS]
D22. Pinch Cock (OC06)-----	[1PCS]

D1



D2

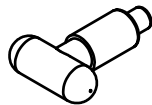

D3



D4



D5



D6

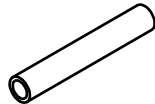

D8

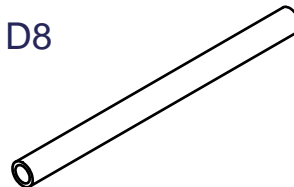

D9



D10

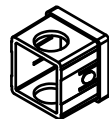

D11

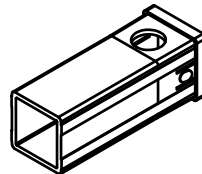

D12



D14



D15

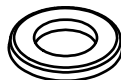

D16

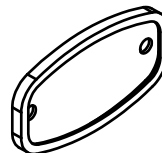

D18



D19

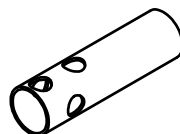

D21



D22



