

FITNESSTRADING



Pro Clubline S1000

2023

PRICELIST RETAIL

CARDIO	6-12
BODY-SOLID HOME / COMMERCIAL GYMS	14-19
BODY-SOLID SMITH MACHINES	19-27
BODY-SOLID POWER RACKS / RACKS	22-27
BODY-SOLID BENCHES /ATTACHMENTS	28-32
BODY-SOLID UPPER BODY	32
BODY-SOLID CABLE CROSS OVERS	33
BODY-SOLID FUNCTIONAL TRAINERS	34-36
BODY-SOLID PREACHER CURL	36
BODY-SOLID LAT STATION	36
BODY-SOLID AB & BACK	37-39
BODY-SOLID HYPEREXTENSION	39
BODY-SOLID VERTICAL KNEE RAISE	40
BODY-SOLID LEG MACHINES	41-43
BODY-SOLID CALF RAISE	43-44
BEST FITNESS	44-46
PRO CLUBLINE SERIES	47-54
PRO CLUBLINE SERIES II	54-57
PRO CLUBLINE LEVERAGE LINE	57-58
BODY-SOLID PRO DUAL LINE	59-61
BODY-SOLID PRO SELECT LINE	61-62
POWERLINE POWER RACKS & OPTIONS	63

PRO CLUBLINE POWER RACKS & OPTIONS	64-67
BODY-SOLID STORAGE	68-75
BODY-SOLID ACCESSORIES	76-83
BODY-SOLID MATS	83-84
BODY-SOLID GRIPS / LAND MINES / T-BAR	84-86
BODY-SOLID FLOORING	86-87
BODY-SOLID PLYO BOXES	88
BODY-SOLID SLEDS	88
BODY-SOLID TOOLS ROPES / BANDS / TUBES / BARS	89-91
BODY-SOLID BALLS	91-94
BODY-SOLID DUMBBELLS	95-96
BODY-SOLID WEIGHT PLATES	97-98
BODY-SOLID BARS / COLLARS / ADAPTERS	99-104
BODYTRADING DUMBBELLS	106
BODYTRADING KETTLEBELLS	106-107
BODYTRADING MACHINES	108
BODYTRADING RESISTANCE BANDS	108
BODYTRADING ACCESSORIES	109-111
POWERBLOCKS	112-117
WARRANTY	119
INDEX	120
TERMS & CONDITIONS	125

All prices include Belgian VAT and exclude shipping costs.

All our deliveries and payment terms shall be filed in accordance with our terms and conditions.

Warranty is on a CARRY-IN basis and supply of spare parts under warranty is based on ex factory delivery.

Warranty is based on replacement of defectuous parts free of charge.
Labour and transport is excluded.

RETAIL PRICE LIST

Body-Solid
Built for Life

Body-Solid
ProClubLine



POWERLINE USA
By Body-Solid



ENDURANCE®
By Body-Solid



TOTAL
abcrunch

POWERBLOCK
WORLD'S BEST DUMBBELL





BodyTrading
EXERCISE AND FITNESS PRODUCTS

WALKDESK
By EVO CARDIO

CARDIO

	ENDURANCE INDOOR EXERCISE BIKE		SPECIFICATIONS
	ITEM#: ESB150		<ul style="list-style-type: none"> • 18 kg flywheel • Quiet and smooth belt drive • Seat and handlebars adjust vertically and horizontally • Micro adjustable handlebars and seat pad • Sealed bearing pivot points • Transport wheels • Max. user weight : 150 kg
	N/G weight: 53 kg / 59.5 kg		
	Dimensions: Product: L 107.8 x W 50.5 x H 122 cm		
	Carton: L 103 x W 99 x H 24 cm		
	Warranty: Frame: lifetime - Parts: 2 years		
ESB150	Endurance Indoor Exercise Bike		€ 995.00



	ENDURANCE SPINNING BIKE		SPECIFICATIONS
	ITEM#: ESB250		<ul style="list-style-type: none"> • 20 kg flywheel • Road style dual sided pedals • Micro adjustable handlebars and seat pad • Easy one touch safety stop • Transport wheels • Comfortably fits users 152 cm and over • Ideal for home and commercial use • Max. user weight : 150 kg • Color: grey and black
	N/G weight: 63 kg / 71.7 kg		
	Dimensions: Product: L 118 x W 50.5 x H 117 cm		
	Carton: L 112 x W 89 x H 26 cm		
	Warranty: Frame: lifetime - Parts: 2 years		
ESB250	Endurance Spinning Bike		€ 1295.00



	ENDURANCE FAN BIKE		SPECIFICATIONS
	ITEM#: FB300		<ul style="list-style-type: none"> • Seat post adjusts horizontally and vertically • Convenient transport wheels • Large steel-resistance fan of 68.5 cm • Best in class sealed bearings • Over tubing/12-gauge steel movement arms • LCD display features quick program buttons, HR, speed, RPM, time, watts and calories • Weight Capacity: 130 kg
	N/G weight: 44 kg / 50 kg		
	Dimensions: Product: L 125.7 x W 60.7 x H 127.5 cm		
	Carton: L 131 x W 88.5 x H 28 cm		
	Warranty: Frame: lifetime - Parts: 2 years		
FB300	Endurance Fan Bike		€ 1250.00



	ENDURANCE ELLIPTICAL TRAINER		SPECIFICATIONS
	ITEM#: E400		<ul style="list-style-type: none"> • Patented Center Drive design • Smooth and quiet motion • Dual-action upper and lower body with premium handgrips and pedals • Adjustable 43-53 cm stride • 20 levels of quiet magnetic resistance • Handles for easy transport • 20 cm step-up height • Max. user weight : 130 kg
	N/G weight: 110.7 kg / 124.7 kg		
	Dimensions: Product: L 127 x W 78.7 x H 167.6 cm		
	Carton: L 117 x W 84 x H 61 cm		
	Warranty: Frame: lifetime - Parts: 2 years		
E400	Endurance Elliptical Adjustable Stride		€ 2795.00



	ENDURANCE ELLIPTICAL SELF GENERATING		SPECIFICATIONS
	ITEM#: E5000		<ul style="list-style-type: none"> • Patented Center Drive design • 20 levels of resistance • Natural 53 cm stride • Easy step-up height • Oversized pedals, close pedal spacing • Handles for easy transport • Self-generated power • Contact heart rate • Max. user weight : 150 kg
	N/G weight: 113 kg / 139.2 kg		
	Dimensions: Product: L 173.7 x W 78.7 x H 175.2 cm		
	Carton: L 137 x W 88 x H 77 cm		
	Warranty: Frame: lifetime - Parts: 2 years		
E5000	Endurance Elliptical Self Generating		€ 3995.00



	ENDURANCE WALK TREADMILL		SPECIFICATIONS
	ITEM#: T50		<ul style="list-style-type: none"> • Motor: high torque 1.5 Hp • Running surface: 48 x 134.5 cm • Speed: 1.6 - 8 km/h • Aluminum foot rails & wide rear entry ramp • Oversized interface button • Easy-to-read led display • Max. user weight: 140 kg
	N/G weight: 73.4 kg / 81.4 kg		
	Dimensions: Product: L 195.5 x W 75 x H 136 cm		
	Carton: L 185 x W 84 x H 33 cm		
	Warranty: Frame: lifetime - Motor: 10 years Running Deck: 5 years Parts: 2 years		
T50	Evocardio Walking Platform Base & Console		€ 1450.00



	ENDURANCE AIR ROWER ITEM#: R300 N/G weight: 36.8 kg / 45 kg Dimensions: Product: L 241.5 W 62 x H 101 cm Carton: L 146 x W 58 x H 38 cm Warranty: Frame: lifetime - Parts: 2 years	 <ul style="list-style-type: none"> • User-controlled air resistance wheel • Flywheel design minimizes noise • Self-generating machine • Ergonomic handle and adjustable footrests • Easy storage • Convenient cell phone holder • 8 different exercise programs • Max. user weight: 150 kg
	R300 Endurance Air Rower	€ 1395.00



 	BEST FITNESS INDOOR TRAINING CYCLE ITEM#: BFSB5 N/G weight: 46 kg / 51.7 kg Dimensions: Product: L 111.7 x W 50.8 x H 111.7 cm Carton: L 103 x W 89 x H 25 cm Warranty: Frame: 10 years - Parts: 2 years	SPECIFICATIONS <ul style="list-style-type: none"> • 18 kg flywheel • Adjustable height and distance • Chain drive system • Transport wheels • Easy to assemble • Low maintenance required • Colour: black & red • Max. weight capacity: 125 kg
BFSB5 Best Fitness Chain Drive Spin Bike	€ 695.00	



 	BEST FITNESS MOUNTAIN CLIMBER ITEM#: BFMC10 N/G weight: 22 kg / 24 kg Dimensions: Product: L 94 x W 50 x H 217 cm Carton: L 169.5 x W 22 x H 15.5 cm Warranty: Frame: 10 years - Parts: 2 years	SPECIFICATIONS <ul style="list-style-type: none"> • Total body cardio workout • Strengthen and tone muscles • Target large muscle groups • Lower body stepper and upper body climber in one machine • Easy to store • Colour: black & red • Max. weight capacity: 150 kg
BFMC10 Best Fitness Mountain Climber	€ 395.00	



	EVOCARDIO RENEGADE AIR BIKE PRO	SPECIFICATIONS
	ITEM#: AB100 N/G weight: 76.5 kg / 81 kg Dimensions: Product: L 123 x W 67.5 x H 142 cm Carton: L 133 x W 43 x H 138 cm Warranty: Frame: lifetime - Parts: 2 years	 <ul style="list-style-type: none"> • Convenient and easy to use • Ideal for people not used to exercising or very overweight people • Low injury risk to knees and ankles • Ideal for fat burning • Air/fan assisted bike • Large LCD Console, wireless receiver • Max. user weight: 150 kg
AB100	EvoCardio Renegade Air Bike Pro	€ 1795.00



	EVOCARDIO RENEGADE AIR ROWER CLASSIC	SPECIFICATIONS
	ITEM#: ARC100 N/G weight: 49.5 kg / 58 kg Dimensions: L 218 x W 61.5 x H 76 cm Carton 1: L 112 x W 40 x H 82 cm Carton 2: L 147 x W 26 x H 23 cm Warranty: Frame: lifetime - Parts: 2 years	 <ul style="list-style-type: none"> • Low impact training / high calorie burning • Air & magnetic resistance system • 8 resistance levels (manual) • Comfortable ergonomic handle • Large LCD screen & several training programs, • Ideal for people not used to exercising or very overweight people • Foldable with 4 transportation wheels • Max. user weight: 150 kg
ARC100	EvoCardio Renegade Air Rower Classic	€ 1695.00



	EVOCARDIO RENEGADE AIR ROWER PRO	SPECIFICATIONS
	ITEM#: ARP100 N/G weight: 49.5 kg / 58 kg Dimensions: L 218 x W 61.5 x H 76 cm Carton 1: L 112 x W 40 x H 82 cm Carton 2: L 147 x W 26 x H 23 cm Warranty: Frame: lifetime - Parts: 2 years	 <ul style="list-style-type: none"> • Low impact training / high calorie burning • Air & magnetic resistance system • 8 resistance levels (Electronic) • Comfortable ergonomic handle • Large LCD screen & several training programs, • Also ideal for people not used to exercising or very overweight people • Foldable with 4 transportation wheels • Max. user weight 150 kg
ARP100	EvoCardio Renegade Air Rower Pro	€ 1750.00

	EVOCARDIO RENEGADE HIIT RUNNER	SPECIFICATIONS
	ITEM#: ARUN050 N/G weight: 135 kg / 155 kg Dimensions: Product: L 171 x W 99 x H 168 cm Carton: L 192 x W 90 x H 46.5 cm Warranty: Frame: lifetime - Running deck: 5 years Parts: 2 years	 <ul style="list-style-type: none"> • Non-motorized treadmill • Perfect for "deadmill running" and HIIT • 8 levels of resistance, • Emulates more natural running experience • Individual rubber slats • Noise: below 80dB • Max. user weight 150 kg
ARUN050	EvoCardio Renegade HIIT Runner	€ 3495.00

	EVOCARDIO RENEGADE AIR RUNNER PRO	SPECIFICATIONS
	ITEM#: ARUN100 N/G weight: 158 kg / N/A Dimensions: Product: L 171 x W 96 x H 171 cm Carton: N/A Warranty: Frame: lifetime - Running deck: 5 years Parts: 2 years	 <ul style="list-style-type: none"> • Non-motorized treadmill • Perfect for "deadmill running" and HIIT • 8 levels of resistance, • Emulates more natural running experience • Individual rubber slats • Noise: below 80dB • Max. user weight 180 kg
ARUN100	EvoCardio Renegade Air Runner Pro	€ 4595.00



	EVOCARDIO RENEGADE HIIT AIR SKI	SPECIFICATIONS
	ITEM#: ASKI100 N/G weight: 23 kg / 26.5 kg Dimensions: Product: D 38 x W 62 x H 80 cm Carton: L 70 x W 58 x H 31 cm Warranty: Frame: lifetime - Parts: 2 years	  <ul style="list-style-type: none"> • Smooth, natural, unlimited airflow • Manual adjustable magnetic resistance (14 levels) • High-strength drive cords • Self-levelling pulley system • Ergonomically designed handle • Stainless steel quick-release mechanism design • Max. users weight: 150 kg
ASKI100	EvoCardio Renegade HIIT Air Ski	€ 1450.00



	EVOCARDIO RENEGADE HIIT AIR SKI		SPECIFICATIONS	
	ITEM#: ASKI150 N/G weight: 61 kg / 72 kg Dimensions: Product: D 38 x W 62 x H 208 cm Carton 1: L 70 x W 58 x H 31 cm Carton 2: L 119 x W 40 x H 17 cm Warranty: Frame: lifetime - Parts: 2 years	 	<ul style="list-style-type: none"> • Manual adjustable magnetic resistance (14 levels) • Oval tubing robust carriage system • "Quick Release" locking system • Lightweight, high-strength drive cords • Self-levelling pulley system • Ergonomically designed handle • Max. users weight: 150 kg 	
ASKI150	Evocardio Renegade HIIT Air Ski		€ 1895.00	

	EVOCARDIO RENEGADE HIIT AIR SKI		SPECIFICATIONS	
	ITEM#: ASKI200 N/G weight: 100.5 kg / 115 kg Dimensions: Product: D 142 x W 62 x H 214 cm Carton 1: L 70 x W 58 x H 31 cm Carton 2: L 132 x W 70 x H 20 cm Warranty: Frame: lifetime - Parts: 2 years	 	<ul style="list-style-type: none"> • Manual adjustable magnetic resistance (14 levels) • Oval tubing robust carriage system • 2 mm thick mainframe construction • "Quick Release" locking system • Lightweight, high-strength drive cords • Self-levelling pulley system • Ergonomically designed handle • Max. users weight: 150 kg 	
ASKI200	Evocardio Renegade HIIT Air Ski		€ 2295.00	

EVOCARDIO WALKDESK

EVOCARDIO

EVOCARDIO WALKING PLATFORM BASE & CONSOLE		SPECIFICATIONS
	ITEM#: WTB500	 <ul style="list-style-type: none"> • 3.0 HP engine / 4000 RPM DC • Speed: 0.8-4 km/h • Walking surface: 51 cm x 123 cm • 2.5 cm thick bakelite, under 12.7 cm height • Oversized 7 cm rollers • 3 hotkeys / LCD console • Bluetooth (iOS & Android App) • Maintenance free • Max. user weight: 180 kg
	N/G weight: 79 kg / 90 kg	
	Dimensions: Product: L 195 x W 72 x H31 cm Carton: L 196 x W 102 x H 38 cm	
	Warranty: Frame: lifetime - Motor: 10 years - Running Deck: 5 years Parts: 2 years	
WTB500	Evocardio Walking Platform Base & Console	€ 1495.00
WTD600	Evocardio Walking Platform Base & Console (WTB500) with Table (WDESK100)	€ 1795.00
WDESK100	Table only	€ 300.00

EVOCARDIO WALKDESK FOLDABLE		SPECIFICATIONS
	ITEM#: WTD600	 <ul style="list-style-type: none"> • 3.0 HP engine / 4000 RPM DC • Speed: 0.8-4 km/h • Walking surface: 51 cm x 123 cm • Oversized 7 cm rollers • 3 hotkeys / LCD console • Bluetooth (iOS & Android App) • Maintenance free • Desktop: 120 x 80 cm (adjustable in height from 110 to 132 cm) • Max. user weight: 180 kg
	N/G weight: 108 kg / 125 kg	
	Dimensions: L 171.4 x W 120 x H 110-132 cm	
	Warranty: Frame: lifetime - Motor: 10 years - Running Deck: 5 years Parts: 2 years	
WTD600	Evocardio Walkdesk Walking Platform Base, Console & Table	€ 1795.00

EVOCARDIO DESK		SPECIFICATIONS
	ITEM#: WDESK100	<ul style="list-style-type: none"> • 3-level horizontal movable Desk • Adjustable Desk Height
	N/G weight: 29 kg / N/A	
	Dimensions: Product: L 80 x W 120 x H 132 cm	
	Warranty: Parts: 2 years	
WDESK100	Evocardio Table for Treadmill	€ 300.00

RUNROCKET

RUN ROCKET		SPECIFICATIONS
	ITEM#: RUNROCK	<ul style="list-style-type: none"> • 20 kg flywheel. • New multi-function digital readout console! • 45 m long running cord. • Body harness (FHN1) included • Large, no-flat wheels across turf or pavement • Durable powdercoating. • Counterbalanced • Additional Olympic plate loading post • Weather resistant components for outdoor use
	N/G weight: N/A	
	Dimensions: Product: L 98 x W 71 x H 100 cm Carton: N/A	
	Warranty: Frame: lifetime - Parts: 2 years	
RUNROCK	Evocardio Runrocket	€ 2295.00

	XTERRA HOMETRAINER		SPECIFICATIONS
	ITEM#: UB2.5 N/G weight: 34.3 kg / 37.2 kg Dimensions: Product: L 101 x W 61 x H 141.5 cm Carton: L 97 x W 64.7 x H 27.5 cm Warranty: Frame: 10 years - Parts: 2 years	<ul style="list-style-type: none"> • 10 kg flywheel system / 3-Piece crank • Ergonomic pedals • Seat adjustment: for/after and up/down • 24 levels of resistance / 15 programs • 6.3 x 12 cm backlit double LCD • Heart rate: contact & telemetric • Max. user weight: 130 kg 	
UB2.5	Xterra Hometrainer	€ 499.00	

	XTERRA HOMETRAINER		SPECIFICATIONS
	ITEM#: UB139 N/G weight: 34.3 kg / 37.2 kg Dimensions: Product: L 101 x W 61 x H 141.5 cm Carton: L 97 x W 64.7 x H 27.5 cm Warranty: Frame: 10 years - Parts: 2 years	<ul style="list-style-type: none"> • 10 kg flywheel system / 3-Piece crank • Ergonomic pedals • Seat adjustment: for/after and up/down • 24 levels of resistance / 15 programs • 6.3 x 12 cm backlit double LCD • Heart rate: contact & telemetric • Max. user weight: 130 kg 	
UB139	Xterra Hometrainer	€ 499.00	

	XTERRA RECUMBENT BIKE		SPECIFICATIONS
	ITEM#: SB2.5 N/G weight: 49 kg / 54 kg Dimensions: Product: L 149 x W 70 x H 104 cm Carton: L 126.4 x W 34 x H 61.2 cm Warranty: Frame: 10 years - Parts: 2 years	<ul style="list-style-type: none"> • 10 Kg flywheel system • Poly V belt • Pedals: oversized, self-leveling • Fore/after seat adjustment • 24 Levels of resistance • 6.3 X 12.7 cm dual color backlit lcd console • 24 programs • Max. user weight: 130 kg 	
SB2.5	Xterra Recumbent Bike	€ 595.00	

	XTERRA ELLIPTICAL		SPECIFICATIONS
	ITEM#: FS2.5 N/G weight: 47 kg / 51 kg Dimensions: Product: L 129 x W 61 x H 160 cm Carton: L 97 x W 64.7 x H 27.5 cm Warranty: Frame: 10 years - Parts: 2 years	<ul style="list-style-type: none"> • 10 kg flywheel system • Oversized pedals with 2° inversion • 20 levels of resistance • Stride length: 35.5 cm • Soft cushioned handlebars • Heart rate: contact & telemetric • 24 programs • Max. user weight: 130 kg 	
FS2.5	Xterra Elliptical	€ 575.00	

	XTERRA ELLIPTICAL		SPECIFICATIONS
	ITEM#: FS3.5 N/G weight: 49.5 kg / 56 kg Dimensions: Product: L 145 x W 52 x H 160 cm Carton: L 145 x W 45 x H 77 cm Warranty: Frame: 10 years - Parts: 2 years	<ul style="list-style-type: none"> • Oversized, minimum height 35 cm above floor level • Stride length: 43 cm • 24 levels of resistance • 12.7 cm bright backlit LCD with storage area, audio input jack, and console speakers • 24 programs • Max. user weight: 125 kg 	
FS3.5	Xterra Elliptical	€ 850.00	

	XTERRA ELLIPTICAL		SPECIFICATIONS
	ITEM#: FS3.9 N/G weight: 70 kg / N/A Dimensions: Product: L 166 x W 56 x H 163 cm Carton: N/A Warranty: Frame: 10 years - Parts: 2 years	<ul style="list-style-type: none"> • Oversized pedals with 2° inversion • Stride length: 46 cm • 15 Levels of resistance • LCD + LED • 15 programs • Max. user weight: 140 kg 	
FS3.9	Xterra Elliptical	€ 995.00	

	XTERRA ELLIPTICAL ITEM#: FS4.0 (untill end off stock) N/G weight: 70 kg / 81 kg Dimensions: Product: L 166 x W 56 x H 163 cm Carton: L 148.5 x W 57 x H 78 cm Warranty: Frame: 10 years - Parts: 2 years	SPECIFICATIONS <ul style="list-style-type: none"> • 10 kg flywheel system, steel • Oversized pedals, 2° Inversion (Allows optimal body alignment) • Stride length: 46 cm • 20 levels of resistance • 15.2 cm blue backlit LCD display console • 18 programs • Max user weight: 150 kg
	FS4.0 Xterra Elliptical	€ 1095.00



	XTERRA ELLIPTICAL ITEM#: FSX3500 N/G weight: 75 kg / 86 kg Dimensions: Product: L 172 x W 57 x H162 cm Carton: L 178 x W 57 x H 86.5 cm Warranty: Frame: 10 years - Parts: 2 years	SPECIFICATIONS <ul style="list-style-type: none"> • Long stride length of 50 cm • Large front driven flywheel • Fan, speakers with auxiliary input, tablet holder and USB connector • Electromagnetic resistance/ 24 levels • 17 Pre-set workouts • Max user weight: 130 kg
	FSX3500 Xterra Elliptical	€ 1395.00



	XTERRA I-POWER ITEM#: I-POWER N/G weight: 61 kg / 68 kg Dimensions: Product: L 172 x W 82 x H 136 cm Folded: L 97 x W 82.5 x H 157 cm Warranty: Frame: 10 years - Motor: 5 years - Running deck: 5 years Parts: 2 years	SPECIFICATIONS <ul style="list-style-type: none"> • Power 2.0 HP continuous duty engine • Maximum speed of 16 km/h • 10 Levels of incline • Low noise level • Heart rate handgrips treadmill • 24 programs • Max. User weight: 120 kg
	I-POWER Xterra I-Power	€ 1095.00



	XTERRA TREADMILL ITEM#: TRX3500 N/G weight: 97 kg / N/A Dimensions: Product: L 196 x W 90 x H 142.5 cm Carton: L 97 x W 82.5 x H 157 cm Warranty: Frame: 10 years - Motor: 5 years - Running deck: 5 years Parts: 2 years	SPECIFICATIONS <ul style="list-style-type: none"> • High torque 3.0 HP motor • maximum speed of 16 km/h • 12 levels of incline • Large running deck of 51 x 152.4 cm • Speed / incline handlebar controls • Heart rate pulse grips • Max. user weight: 150 kg
	TRX3500 Xterra Treadmill	€ 1395.00



	XTERRA ROWER ITEM#: ERG600W N/G weight: 37 kg / N/A Dimensions: Product: L 205 x W 56 x H 84 cm Warranty: Frame: 10 years - Parts: 2 years	SPECIFICATIONS <ul style="list-style-type: none"> • Impellers active motion through the water tank • Raised seat height (34 cm high) • 6 Water-based resistance levels • Large cd console of 14 cm • 5 Programmable modes
	ERG600W Xterra Rower	€ 795.00



STRENGTH BODY-SOLID



FUSION 600 PERSONAL TRAINER		SPECIFICATIONS
	ITEM#: F600 Weight: 265 kg Dimensions: L 193 x W 122 x H 210.8 cm Warranty: In-Home Lifetime / Light Commercial (P. 119)	 <ul style="list-style-type: none"> Adjustable "user defined" functional training arm 95 kg weight stack / 140 kg stack optional Optional leg press station with 2:1 ratio 11 Gauge oval steel construction Hydraulic seat adjustments
	F600-2 Fusion Personal Trainer with Bi-Angular press arm, 95 kg stack € 3395.00 F600-3 Fusion Personal Trainer with Bi-Angular press arm, 140 kg stack € 3695.00	
OPTIONAL ATTACHMENTS		
FLP Fusion Leg Press Attachment € 979.00 FMH Fusion Multi-hips station € 349.00 FKR Fusion Vertical Knee Raise / Dip Station € 299 .00 FPU Fusion Pull-up Bar Attachment € 99.00 FCDWA Fusion Weight Assisted Chin Dip Attachment € 949.00		

FUSION LEG PRESS ATTACHMENT		SPECIFICATIONS
	ITEM#: FLP Weight: 77.6 kg Dimensions: L 198.5 x W 101 x H 96.5 cm Attached: W 202 cm Warranty: In-Home Lifetime / Light Commercial (P. 119)	 <ul style="list-style-type: none"> For F500 & F600 2:1 Ratio Rubber coated foot plate Double beamed pivot self-aligns to your ankle angles Industrial pillow block
	FLP Fusion Leg Press Attachment for F600/2 and F600/3 € 979.00	

FUSION MULTI HIP ATTACHMENT		SPECIFICATIONS
	ITEM#: FMH Weight: 21.3 kg Dimensions: L 105 x W 64 x H 110 cm Attached: W 208 cm Warranty: In-Home Lifetime / Light Commercial (P. 119)	 <ul style="list-style-type: none"> 4 way leg workout from a hip pivot For F500 & F600 Thigh adduction, Thigh abduction, Leg kick & Leg lift Cam adjustment for full range of motion Easy handles for stabilization
	FMH Fusion Multi Hip Attachment for F600/2 and F600/3 € 349.00	

VERTICAL KNEE RAISE ATTACHMENT		SPECIFICATIONS
	ITEM#: FKR Weight: 22.8 kg Dimensions: L 253.7 x W 127.4 x H 210.8 cm Warranty: In-Home Lifetime / Light Commercial (P. 119)	 <ul style="list-style-type: none"> Mounts to the back of the gym for minimal space For F500 & F600 Knee raises Leg lifts Dips with comfortable over-sized grips Obliques
	FKR Fusion Vertical Knee Raise Attachment for F600/2 and F600/3 € 299.00	

PULL UP BAR ATTACHMENT		SPECIFICATIONS
	ITEM#: FPU Weight: 4 kg Dimensions: L 50 x W 114 x H 200 cm Warranty: In-Home Lifetime / Light Commercial (P. 119)	 <ul style="list-style-type: none"> For F500 & F600 Variable hand position chin ups Wide grip lat pull ups
	FPU Fusion Pull Up Bar Attachment for F600/2 and F600/3 € 99.00	

WEIGHT ASSISTED CHIN DIP ATTACHMENT		SPECIFICATIONS
	ITEM#: FCDWA Weight: 78 kg Dimensions: L 165 x W 147.3 x H 210.8 cm Warranty: In-Home Lifetime / Light Commercial (P. 119)	 <ul style="list-style-type: none"> For F500 & F600 Variable hand position chin ups Wide grip lat pull ups
	FCDWA Fusion Weight Assisted Chin Dip Attachment for F600/2 and F600/3 € 949.00	



	G1S SELECTORIZED HOME GYM		SPECIFICATIONS
	ITEM#: G1S		<ul style="list-style-type: none"> • 72.5 kg weight stack • Includes lat bar, straight bar and utility strap • Workout placard included
	Weight:	151 kg	
	Dimensions:	L 140.2 x W 120 x H 210.8 cm	
	Warranty:	In-Home Lifetime (P. 119)	
G1S	Body-Solid G1S Selectorized Home Gym		€ 1395.00



	G3S SELECTORIZED HOME GYM		SPECIFICATIONS
	ITEM#: G3S		<ul style="list-style-type: none"> • 72.5 kg weight stack / 95 kg available • Includes lat bar, straight bar and utility strap • Full size workout poster • Chest supported mid-row • Optional leg press station with 2:1 ratio
	Weight:	154.3 kg	
	Dimensions:	L 186.4 x W 119.4 x H 213.3 cm	
	Warranty:	In-Home Lifetime (P. 119)	
G3S	Body-Solid G3S Selectorized Home Gym		€ 1895.00
OPTIONAL ATTACHMENTS			
GLP	Optional Leg Press Station		€ 995.00
GCCA	Optional Cable Column Attachment		€ 849.00
GIOT	Optional Seated Inner / Outer Thigh Attachment		€ 1095.00



	G6B BI-ANGULAR™ HOME GYM		SPECIFICATIONS
	ITEM#: G6B		<ul style="list-style-type: none"> • Hydraulic seat adjustments • 95 kg weight stack / 117.5 kg available • Optional leg press station with 2:1 ratio • 5 X 7.5 cm mainframe construction • Range limiters on pec station
	Weight:	252.6 kg	
	Dimensions:	L 212 x W 148 x H 211 cm	
	Warranty:	In-Home Lifetime / Light Commercial (P. 119)	
G6B	Body-Solid G6B Bi-Angular™ Home Gym		€ 2995.00
OPTIONAL ATTACHMENTS			
GLP	Optional Leg Press Station		€ 995.00
GCCA	Optional Cable Column Attachment		€ 849.00
GIOT	Optional Seated Inner / Outer Thigh Attachment		€ 1095.00



	G9S SELECTORIZED HOME GYM		SPECIFICATIONS
	ITEM#: G9S		<ul style="list-style-type: none"> • Hydraulic seat adjustments • 95 kg weight stack / 117.5 kg available • Leg Press station with 2:1 ratio • 5 x 7.5 cm mainframe construction • Range limiters on Pec Station
	Weight:	437 kg	
	Dimensions:	L 226 x W 193 x H 212 cm	
	Warranty:	In-Home Lifetime / Light Commercial (P. 119)	
G9S	Body-Solid G9S Selectorized Home Gym with Leg Press (GLP)		€ 4995.00
OPTIONAL ATTACHMENTS			
GIOT	Optional Seated Inner / Outer Thigh Attachment		€ 1095.00
GKR9	Optional Vertical Knee Raise Station for G9S		€ 399.00

	G10 B BI-ANGULAR™ HOME GYM		SPECIFICATIONS
	ITEM#: G10B		<ul style="list-style-type: none"> • Hydraulic seat adjustments • Two 95 kg weight stack / 117.5 kg available • Optional Leg Press station with 2:1 ratio • 5 x 7.5 cm mainframe construction • Two users can workout simultaneously • Leg Ext. / Leg Curl with adjustable cam
	Weight:	430.5 kg	
	Dimensions:	L 182.8 x W 302.3 x H 212 cm	
	Warranty:	In-Home Lifetime / Light Commercial (P. 119)	
G10B	Body-Solid G10B Bi-Angular™ Home Gym		€ 4995.00
OPTIONAL ATTACHMENTS			
GLP	Optional Leg Press Station		€ 995.00
GCCA	Optional Cable Column Attachment		€ 849.00
GIOT	Optional Seated Inner / Outer Thigh Attachment		€ 1095.00

	PREMIUM LEG PRESS / CALF PRESS	SPECIFICATIONS
	ITEM#: GLP Weight: 67 kg Dimensions: L 157.7 x W 144 x H 90 cm Warranty: In-Home Lifetime / Light Commercial (P. 119)	 <ul style="list-style-type: none"> • For G2B, G3S, G4I, G5S, G6B, G10B • 2 to 1 weight ratio doubles resistance from stock weight stack • Non-slip rubber coated steel foot plate
GLP	Body-Solid Leg Press/Calf Press Attachment	€ 995.00
OPTIONAL ATTACHMENTS		
GLP-STK	GLP Leg Press with 95 kg Weight Stack	€ 1995.00
GLP-STK-3	GLP Leg Press with 140 kg Weight Stack	
STK	Free Standing 95 kg Weight Stack	€ 950.00

	SEATED INNER/OUTER THIGH ATTACHMENT	SPECIFICATIONS
	ITEM#: GIOT Weight: 53 kg Dimensions: L 106 x W 196.6 x H 95 cm Warranty: In-Home Lifetime / Light Commercial (P. 119)	 <ul style="list-style-type: none"> • For G2B, G3S, G4I, G5S, G6B, G9S, G10B • Comfortable seated design for inner / outer thigh exercise • 5 position adjustments provide full range of motion for all users
GIOT	Body-Solid Seated Inner / Outer Thigh Attachment	€ 1095.00
OPTIONAL ATTACHMENTS		
GIOT-STK	GIOT with Free Standing 95 kg Weight Stack	€ 1995.00
STK	Free Standing 95 kg Weight Stack	€ 950.00

	CABLE COLUMN ATTACHMENT	SPECIFICATIONS
	ITEM#: GCCA Weight: 37.7 kg Dimensions: L 180.3 x W 236.2 x H 212 cm Warranty: In-Home Lifetime / Light Commercial (P. 119)	 <ul style="list-style-type: none"> • For G2B, G3S, G5S, G6B, G10B • Pivoting quad pulley carriage with dual handles • Chrome vertical column with 10 adjustment holes
GCCA	Body-Solid Cable Column Attachment	€ 849.00

	VERTICAL KNEE RAISE AND DIP STATION	SPECIFICATIONS
	ITEM#: GKR9 Weight: 38.3 kg Dimensions: L 68.2 x W 120 x H 190 cm Warranty: In-Home Lifetime / Light Commercial (P. 119)	 <ul style="list-style-type: none"> • For G9S • Large anti-slip hand grips • Thick and large arm pads • Thick and comfortable DuraFirm upholstery
GKR9	Body-Solid Vertical Knee Raise & Dip Station	€ 399.00

	BI-ANGULAR WHITE MULTI GYM		SPECIFICATIONS
	ITEM#: EXM2750G	FC FULL COMMERCIAL RATED	<ul style="list-style-type: none"> • Easy to use, space saving, no-cable-change design. • Pec dec handles for high performance • 1000 kg tension Strength, military spec, steel aircraft cables • CAM system on the press Leg Extension
	Weight: 252 kg		
	Dimensions: L 175 x W 109 x H 211 cm		
	Warranty: Full Commercial (P. 119)		
EXM2750G	Body-Solid Bi-Angular White Multi Gym		€ 2595.00
OPTIONAL ATTACHMENTS			
LP275	Optional Leg Press / Calf Press Station		€ 850.00

	OPTIONAL LEG PRESS FOR EXM2750G		SPECIFICATIONS
	ITEM#: LP275	FC FULL COMMERCIAL RATED	<ul style="list-style-type: none"> • Precise and very quick adjustable • Leg press 2:1 ratio up to 190 kg of resistance weight • Extra large platform : turning and anti-slip • Hand grips on each side
	Weight: 66 kg		
	Dimensions: L 127 x W 53.5 x H 203 cm		
	Warranty: Full Commercial (P. 119)		
LP275	Body-Solid Leg Press for EXM2750G		€ 850.00

	SELECTORIZED HOME GYM		SPECIFICATIONS
	ITEM#: EXM4000S	FC FULL COMMERCIAL RATED	<ul style="list-style-type: none"> • Hydraulic Seat Adjustments • Three 95 kg Weight Stacks • OPTIONAL Leg Press Station adds a 4th 95 kg Weight Stack • 5 x 10 cm Mainframe Construction • Four users can workout simultaneously
	Weight: 606.7 kg		
	Dimensions: L 328.8 x W 235.5 x H 210.8 cm		
	Warranty: Full Commercial (P. 119)		
EXM4000S	Body-Solid Selectorized Home Gym		€ 8895.00
OPTIONAL ATTACHMENTS			
LP40S	Optional Leg Press / Calf Press Station		€ 2695.00

	OPTIONAL LEG PRESS FOR EXM4000S		SPECIFICATIONS
	ITEM#: LP40S	FC FULL COMMERCIAL RATED	<ul style="list-style-type: none"> • Precise and fast adjustable • Leg press 2:1 ratio up to 190 kg of resistance weight • Extra large platform : turning and anti-slip • Hand grips on each side • Weight stack 95 kg
	Weight: 231.9		
	Dimensions: L 197.7 x W 141 x H 100 cm		
	Warranty: Full Commercial (P. 119)		
LP40S	Body-Solid Leg Press for EXM4000S		€ 2849.00

	CORNER LEVERAGE GYM BASE		SPECIFICATIONS
	ITEM#: GLGS100	C COMMERCIAL RATED	<ul style="list-style-type: none"> • Revolutionary, Space Saving design • Press Arm station has a large radius to greater simulate a straight up and down motion • Replicate freeweight movements in total safety
	Weight: 86.8 kg		
	Dimensions: L 175.2 x W 170.2 x H 208.2 cm		
	Warranty: In-Home Lifetime / Light Commercial (P. 119)		
GLGS100	Body-Solid Corner Leverage Gym		€ 1595.00
OPTIONAL ATTACHMENTS			
GFID100	Flat / Incline / Decline Bench		€ 345.00
GLGSWH25	Set Weight Horns For GLGS100 25 mm		€ 29.00
WT46	Olympic Weight Tree		€ 179.00

	CORNER LEVERAGE GYM PACKAGE		PACKAGE INCLUDES
	ITEM#: GLGS100P4	C COMMERCIAL RATED	<ul style="list-style-type: none"> • GLGS100 Corner Leverage Gym • GFID100 Flat / Incline / Decline Bench
	Weight: 111 kg		
	Dimensions: N/A		
	Warranty: In-Home Lifetime / Light Commercial (P. 119)		
GLGS100P4	Body-Solid Corner Leverage Gym Package		€ 1950.00

	BEST FITNESS SPORTSMAN GYM		SPECIFICATIONS
	ITEM#: BFMG20 Weight: 119 kg Dimensions: L 162.5 x W 119.4 x H 198 cm Warranty: Frame: 10 years - Parts: 2 years	<ul style="list-style-type: none"> • 68 kg weight stack • Chest Press • Pec Fly • High and Low Pulley • Leg Extension and Leg Curl 	
BFMG20	Best Fitness Sportsmans Gym		€ 749.00

	BEST FITNESS HOME GYM		SPECIFICATIONS
	ITEM#: BFMG30 Weight: 153 kg Dimensions: L 182 x W 1198.3 x H 210.8 cm Warranty: Frame: 10 years - Parts: 2 years	<ul style="list-style-type: none"> • Multi-functional, fully-adjustable single-stack gym • No cable-change design • Welded steel mainframe • Sealed bearings • Five unique workout stations for a full-body workout • 65 kg weight stack 	
BFMG30	Best Fitness Home Gym		€ 1295.00

	POWERLINE HARDCORE GYM		SPECIFICATIONS
	ITEM#: PHG1000X Weight: 53.5 kg Dimensions: L 155 x W 107.3 x H 213.3 cm Warranty: Frame: 10 years - Parts: 2 years	<ul style="list-style-type: none"> • Available as Plate Load or Selectorized • Compact Footprint • Front Access Design • Includes Lat Bar, Straight Bar & Utility Strap 	
PHG1000X	Powerline Hardcore Gym		€ 695.00
OPTIONAL ATTACHMENTS			
SP150	Optional 150Lb. Selectorized Weight Stack Upgrade for PHG1000X		€ 390.00
OAS8	Optional 20 cm Olympic Adapter Sleeve		€ 12.00
OAS14	Optional 35 cm Olympic Adapter Sleeve		€ 20.00

	POWERLINE HOME GYM		SPECIFICATIONS
	ITEM#: BSG10X Weight: 171.7 kg Dimensions: L 168.3 x W 118.3 x H 203.2 cm Warranty: Frame: 10 years - Parts: 2 years	<ul style="list-style-type: none"> • Easy to use, space saving, no-cable-change design • Compact Footprint / Pre-Cabled • 20 Minute Assembly • Over 30 exercises • 9 Bolt Assembly 	
BSG10X	Powerline Home Gym		€ 1595.00
OPTIONAL ATTACHMENTS			
BSGLPX	Optional Powerline Leg Press for BSG10X		€ 169.00

	POWERLINE LEG PRESS FOR BSG10X		SPECIFICATIONS
	ITEM#: BSGLPX Weight: 9 kg Dimensions: N/A Warranty: Frame: 10 years - Parts: 2 years	<ul style="list-style-type: none"> • For use with the BSG10X Home Gym only 	
BSGLPX	Powerline Leg Press for BSG10X		€ 169.00

	POWERLINE HOME GYM		SPECIFICATIONS
	ITEM#: P2X Weight: 177.3 kg Dimensions: L 174.4 x W 126.6 x H 210.8 cm Warranty: Frame: 10 years - Parts: 2 years	<ul style="list-style-type: none"> • Chest, Incline, Shoulder Press • Chest Supported Mid Row • Adjustable Back & Seat Pad • Oval Tubing • Pivoting cable handles 	
P2X	Powerline Home Gym		€ 1995.00
OPTIONAL ATTACHMENTS			
PLPX	Optional Powerline Leg Press for P1X and P2X		€ 645.00
SP150	Optional 22.5 kg Selectorized Weight Stack Upgrade		€ 390.00

	POWERLINE LEG PRESS FOR P1X & P2X	SPECIFICATIONS
	ITEM#: PLPX Weight: 46.8 kg Dimensions: L 144.8 x W 58.4 x H 80 cm Warranty: Frame: 10 years - Parts: 2 years	<ul style="list-style-type: none"> • 2:1 ratio • Pivoting press plate • Extra large, extra wide, non-slip press plate • Side stability handles • For Powerline P1X or P2X Home Gym only
PLPX	Powerline Leg Press for P1X & P2X	€ 645.00



	WEIGHT STACK ADD-ON-KIT	SPECIFICATIONS
	ITEM#: SP150 Weight: 67.5 kg Dimensions: L 26.5 x W 12 x H 36 cm Warranty: Parts: 2 years	<ul style="list-style-type: none"> • Takes the standard weight stack to a new level of performance. • Fast and simple installation make this a must-have for your plate load system.
SP150	Weight Stack Add-On-Kit 67.5 kg	€ 390.00



	POWERLINE SMITH MACHINE	SPECIFICATIONS
	ITEM#: PSM144X Weight: 72 kg Dimensions: L 113 x W 192.5 x H 203.2 cm Warranty: Frame: 10 years - Parts: 2 years	<ul style="list-style-type: none"> • 14-Lockout Points • Heavy-Duty Adjustable Safeties • Diamond plate foot platform • Super-Glide Bushings
PSM144X	Powerline Smith Machine	€ 625.00
OPTIONAL ATTACHMENTS		
PLA144X	Powerline Lat Row Station	€ 389.00
PPA13X	Powerline Pec Attachment	€ 249.00
OAS8	Optional 20 cm Olympic Adapter Sleeve	€ 12.00
OAS14	Optional 35 cm Olympic Adapter Sleeve	€ 20.00



	POWERLINE SMITH MACHINE SYSTEM	SPECIFICATIONS
	ITEM#: PSM144XS Weight: 193.7 kg Dimensions: L 113 x W 192.5 x H 216 cm Warranty: Frame: 10 years - Parts: 2 years	<ul style="list-style-type: none"> • 14-Lockout Points • Heavy-Duty Adjustable Safeties • Diamond plate foot platform • Super-Glide Bushings
PSM144XS	Powerline Smith Machine System	2150.00
PACKAGE INCLUDES		
PSM144X	Powerline Smith machine	€ 625.00
PLA144X	Powerline Lat Row Station	€ 389.00
PPA13X	Powerline Pec Attachment	€ 249.00
PFID130X	Powerline Flat • Incline • Decline Bench	€ 229.00
GLDA1	Leg Developer - 4 Roller for PFID130X	€ 129.00
GPCA1	Preacher Curl Attachment	€ 129.00
SP150	Selectorized Weight Stack	€ 390.00
OPTIONAL ATTACHMENTS		
OAS8	Optional 20 cm Olympic Adapter Sleeve	€ 12.00
OAS14	Optional 35 cm Olympic Adapter Sleeve	€ 20.00



	POWERLINE LAT ROW STATION	SPECIFICATIONS
	ITEM#: PLA144X Weight: 44.5 kg Dimensions: N/A Warranty: Frame: 10 years - Parts: 2 years	<ul style="list-style-type: none"> • High and low pulleys deliver smooth, consistent resistance for lat pulldowns, triceps pressdowns, cable crossovers, seated rows and more. Plate loaded carriage. This item does not include weight stack.
PLA144X	Powerline Lat Row Station	€ 389.00



SMITH MACHINES & ATTACHMENTS

 	POWERLINE PEC DEC ATTACHMENT	SPECIFICATIONS
	ITEM#: PPA13X Weight: 15 kg Dimensions: N/A Warranty: Frame: 10 years - Parts: 2 years	<ul style="list-style-type: none"> Perform Pec Fly's for fast and effective chest development
PPA13X	Powerline Pec Dec Attachment	€ 249.00

	SERIES 7 SMITH FULL OPTION	SPECIFICATIONS
	ITEM#: GS348FB Weight: 328.4 kg Dimensions: L 249 x W 175.3 x H 210.8 cm Warranty: In-Home Lifetime / Light Commercial (P. 119)	 <ul style="list-style-type: none"> 14-Lockout Points Heavy-Duty Adjustable Safeties Diamond plate foot platform Super-Glide Bushings Barbell, weight & clips not included
GS348FB	Body-Solid Series 7 Linear Bearing Smith Full Option - Ø 50 mm Includes Gunracks, Safeties, Weight Horns	€ 4712.00
GS348FB-25S	Body-Solid Series 7 Linear Bearing Smith Full Option - Ø 25 mm Includes Gunracks, Safeties, Weight Horns	€ 4712.00
PACKAGE INCLUDES		
GS348Q	Series 7 Linear Bearing Smith Machine	€ 2095.00
GLA348Q	Selectorized Lat Attachment	€ 1095.00
GFID71	Flat / Incline / Decline Bench	€ 495.00
GPA3	Pec Dec Station for GLA348QS	€ 289.00
GPCA1	Preacher Curl Bench / GPA3 Pec Dec Station	€ 129.00
GLDA3	Leg Developer Station	€ 129.00

	SERIES 7 LINEAR BEARING SMITH MACHINE	SPECIFICATIONS
	ITEM#: GS348Q Weight: 125.3 kg Dimensions: L 144.2 x W 175.4 x H 210.8 cm Warranty: In-Home Lifetime / Light Commercial (P. 119)	 <ul style="list-style-type: none"> 7° Reverse Pitch Design 11 Gauge 5 x 7.6 cm Construction 14-Position Gunrack & Safeties 6 Olympic Weight Plate Storage Posts Barbell, weight & clips not included
GS348Q	Body-Solid Series 7 Linear Bearing Smith Machine - Ø 50 mm Includes Gunracks, Safeties, Weight Horns	€ 2095.00
GS348Q-25S	Body-Solid Series 7 Linear Bearing Smith Machine - Ø 25 mm Includes Gunracks, Safeties, Weight Horns	€ 2095.00
OPTIONAL ATTACHMENTS		
GLA348	Selectorized Lat Attachment	€ 1095.00
GPA3	Pec Dec Station for GLA348QS	€ 289.00
SCB26	Squat / Calf Block	€ 149.00

	SELECTORIZED LAT ATTACHMENT	SPECIFICATIONS
	ITEM#: GLA348QS Weight: 135.4 kg Dimensions: L 198 x W 175.5 x H 212.8 cm Warranty: In-Home Lifetime / Light Commercial (P. 119)	
GLA348QS	Selectorized Lat Attachment for GS348Q & GS348FB	€ 1095.00

	OPTION PEC DEC STATION	SPECIFICATIONS
	ITEM#: GPA3 Weight: 16 kg Dimensions: N/A Warranty: In-Home Lifetime / Light Commercial (P. 119)	 <ul style="list-style-type: none"> Deliver a full-range unilateral or bi-lateral pec-fly motion. Features Extra-thick back and arm roller pads for ultimate comfort.
GPA3	Option Pec Dec Station for GS348Q & GS348FB	€ 289.00

	OPTION PULL-UP BAR	SPECIFICATIONS
	<p>ITEM#: GPU348</p> <p>Weight: 3.8 kg</p> <p>Dimensions: L 121.5 x W 13 x H 8 cm</p> <p>Warranty: In-Home Lifetime / Light Commercial (P. 119)</p>	<ul style="list-style-type: none"> • Knurled pull-up bar for pull-up and chin-up exercises • Exclusively for GS348Q Smith Machine only. • NOT COMPATIBLE with the Body-Solid GS348QP4 Smith Machine Package, or units with the GLA348QS Lat Attachment
GPU348	Option Pull-Up bar for GS348 Smith Machine	€ 99.00

	WEIGHT STACK ADD-ON-KIT	SPECIFICATIONS
	<p>ITEM#: SP200</p> <p>Weight: 90 kg (20 x 4,5 kg)</p> <p>Dimensions: L 26.5 x W 12 x H 40 cm</p> <p>Warranty: Parts: 2 years</p>	<ul style="list-style-type: none"> • Takes the standard weight stack to a new level of performance. • Fast and simple installation make this a must-have for your plate load system.
SP200	Weight Stack Add-On-Kit 90 kg	€ 520.00

PRO CLUBLINE COMMERCIAL HALF RACK		SPECIFICATIONS
	ITEM#: SPR500	<ul style="list-style-type: none"> 7.6 x 7.6 cm 11-gauge steel Mainframe Includes premium J-cup Liftoffs Includes safety Spotter Arms Integrated Chinning Bar More info on page 66
	Weight: 96 kg Dimensions: L 127.6 x W 133.5 x H 226.7 cm Warranty: In-Home Lifetime / Full Commercial (P. 119)	
SPR500	Pro Clubline Commercial Power Half Rack Includes Liftoffs and Premium Safeties	€ 995.00
OPTIONAL		
SPR500HALFBACK	Rear Extension with 4 Weight Horns for SPR500	€ 695.00
SPRHLA	Lat attachment for SPR500	€ 595.00

PRO CLUBLINE LAT ATTACHMENT FOR SPR500		SPECIFICATIONS
	ITEM#: SPRHLA	<ul style="list-style-type: none"> Add workout variety & versatility to half rack Compatible only with the Body-Solid SPR500 and SPR500Back 1000 kg tested nylon-coated aircraft quality cables No cable change design Includes lat bar and a low row bar Full Commercial (P. 119) Warranty
	Weight: 41 kg Dimensions: L 185.5 x W 134.6 x H 226 cm Warranty: In-Home Lifetime / Full Commercial (P. 119)	
SPRHLA	Pro Clubline Lat Attachment for SPR500	€ 595.00

PRO CLUBLINE HALF RACK EXTENSION		SPECIFICATIONS
	ITEM#: SPR500HALFBACK	<ul style="list-style-type: none"> Extends the SPR500 Half Rack without increasing the usage footprint Includes four weight horns Perfect place to add more storage for accessories Combine with pin and pipe safeties (SPRPS) for a rack pull station
	Weight: 59.5 kg Dimensions: L 204.5 x W 65 x H 227 cm Warranty: In-Home Lifetime / Full Commercial (P. 119)	
SPR500HALFBACK	Pro Clubline Commercial Half Rack Extension	€ 695.00

PRO CLUBLINE COMMERCIAL HALF RACK		SPECIFICATIONS
	ITEM#: SPR500BACK	<ul style="list-style-type: none"> 7.6 x 7.6 cm 11-gauge steel Mainframe Includes premium J-cup Liftoffs Includes safety Spotter Arms Integrated Chinning Bar Includes expansion with 4 Weight Horns More info on page 66
	Weight: 156 kg Dimensions: L 127.6 x W 204.6 x H 227.6 cm Warranty: In-Home Lifetime / Full Commercial (P. 119)	
SPR500BACK	Pro Clubline Commercial Half Rack Back	€ 1595.00
PACKAGE INCLUDES		
SPRJC	Premium J-Cup Liftoffs	€ 119.00
SPRSA	Safety Spotter Arms	€ 189.00
SPRDCB	Chinning Bar	€ 125.00
SR-WPH	4 Weight Horns (€ 55.00 per weight horn)	€ 220.00

PRO CLUBLINE COMMERCIAL DOUBLE HALF RACK		SPECIFICATIONS
	ITEM#: SPR500DBL	<ul style="list-style-type: none"> 7.6 x 7.6 cm 11-gauge steel Mainframe 25 mm hole spacing for J-cups and safeties Includes (4) cup liftoffs, (4) safety spotter arms, (2) chinning bars and (6) weight horns Laser-cut numbers More info on page 66
	Weight: 246.5 kg Dimensions: L 256.5 X W 216 X H 226 CM Warranty: In-Home Lifetime / Full Commercial (P. 119)	
SPR500DBL	Pro Clubline Commercial Double Half Rack	€ 2485.00

PRO CLUBLINE POWER RACK		SPECIFICATIONS
	ITEM#: SPR1000	<ul style="list-style-type: none"> Ø 7.6 cm 11-gauge steel Mainframe 2.5 cm hole spacing for safety spotter bars Expansion for weight storage and spotter access Monkey bar expansion bolts two racks together More info on page 66
	Weight: 159 kg Dimensions: L 205.7 x W 134 x H 226.7 cm Warranty: In-Home Lifetime / Full Commercial (P. 119)	
SPR1000	Pro Clubline Commercial Power Rack Includes Lift-offs and Premium Safeties	€ 1795.00

	PRO CLUBLINE POWER RACK/EXTENSION		SPECIFICATIONS
	ITEM#: SPR1000BACK	FC FULL COMMERCIAL RATED	<ul style="list-style-type: none"> • Ø 7.6 cm 11-gauge steel Mainframe • 2.5 cm hole spacing for safety spotter bars • Expansion for weight storage and spotter access • Monkey bar expansion bolts two racks together <p>More info on page 66</p>
SPR1000BACK	Pro Clubline Commercial Power Rack & Extension Includes SPR1000 & SPRBACK		€ 2495.00



	PRO CLUBLINE DOUBLE POWER RACK		PACKAGE INCLUDES
	ITEM#: SPR1000DB	FC FULL COMMERCIAL RATED	<ul style="list-style-type: none"> • Includes two complete SPR1000 Commercial Power Racks and the SPRMB Monkey Bar Cross Member • Ø 7.6 cm 11-gauge steel Mainframe • 2.5 cm hole spacing for safety spotter bars
SPR1000DB	Pro Clubline Commercial Double Power Racks with Monkey Bar Includes two SPR1000 & SPRMB		€ 3695.00



	PRO CLUBLINE DOUBLE POWER RACK/EXTENSION		PACKAGE INCLUDES
	ITEM#: SPR1000DBBACK	FC FULL COMMERCIAL RATED	<ul style="list-style-type: none"> • Includes two complete SPR1000BACK Commercial Extended Power Racks and the SPRMB Monkey Bar Cross Member • Ø 7.6 Cm 11-gauge steel mainframe • 2.5 Cm hole spacing for safety spotter bars • Includes expansion for weight storage and • Spotter access on both racks
SPR1000DBBACK	Pro Clubline Commercial Double Power Racks and Extension Includes two SPR1000, two SPRBACK & SPRMB		€ 5495.00



	POWER RACK		SPECIFICATIONS
	ITEM#: GPR378	C COMMERCIAL RATED	<ul style="list-style-type: none"> • Ø 7.6 cm 11 gauge steel construction • 20 vertical adjustments • Oversize safety bars • Commercial Design
GPR378	Body-Solid Power Rack		€ 995.00
OPTIONAL ATTACHMENTS			
DR378	Dip Attachment		€ 129.00
SCB26	Squat / Calf Block		€ 149.00
GLA378	Lat Attachment for GPR378		€ 525.00
LO378	Lift Offs for GPR378		€ 79.00
SP200	Weight Stack Upgrade 90 kg plates and top plate		€ 520.00



	LAT ATTACHMENT FOR GPR378		SPECIFICATIONS
	ITEM#: GLA378	C COMMERCIAL RATED	<ul style="list-style-type: none"> • High / Low Pulley • No cable change design • Optional 95 kg stack • Comes with Lat Bar & Low Row Bar
GLA378	Body-Solid Lat Attachment for GPR378		€ 525.00
OPTIONAL ATTACHMENTS			
SP200	Weight Stack Upgrade 90 kg plates and top plate		€ 520.00



	DIP ATTACHMENT FOR GPR378		PACKAGE INCLUDES
	ITEM#: DR378	C COMMERCIAL RATED	<ul style="list-style-type: none"> • Heavy gauge steel for extreme workouts • Large Ø 3.8 cm grips for extra comfort • Tapered handles ensure proper fit • Adjustable to several starting positions • Spans both safeties for unsurpassed stability
DR378	Body-Solid Dip Attachment for GPR378		€ 129.00



	LIFT OFFS FOR GPR378		PACKAGE INCLUDES
	ITEM#: L0378 Weight: 5 kg Dimensions: L 23 x W 2 x H 14 cm Warranty: In-Home Lifetime / Light Commercial (P. 119)		<ul style="list-style-type: none"> This extra pair of Lift-offs make your workouts more efficient. Allow you to set up bars for a number of different routines including squats, rows, curls and more.
L0378	Body-Solid Lift Offs for GPR378		€ 79.00

	POWER RACK		PACKAGE INCLUDES
	ITEM#: GPR400 Weight: 123.8 kg Dimensions: L 133.5 x W 132 x H 201 cm Warranty: In-Home Lifetime / Light Commercial (P. 119)		<ul style="list-style-type: none"> Wide walk-in design 5 cm hole spacing for safeties Includes pipe & pin safeties and j-cup liftoffs Integrated 32 mm pull-up bar Optional attachments and accessories Weight capacity: 450 kg
GPR400	Body-Solid Power Rack		€ 895.00
OPTIONAL ATTACHMENTS			
SPRPLATFORM	Power Rack Floor Mat		€ 1395.00
GLA400	Lat Attachment		€ 549.00
GPRDH	Dip Handles		€ 69.00
GPRTBR	T-Bar Row Attachment		€ 49.00
GPRUL	U-Link Attachment		€ 45.00
GPRWH	Weight Horns		€ 45.00
SPRCUA	Multigrip Chin Up bar for SPR100 and GPR400		€ 249.00
SP150	Weight Stack		€ 390.00

	LAT ATTACHMENT FOR GPR400		SPECIFICATIONS
	ITEM#: GLA400 Weight: 38.5 kg Dimensions: L 130.4 x w 132 x H 203 cm Warranty: 6 Months		<ul style="list-style-type: none"> Includes lat bar and low row bar
GLA400	Body-Solid Lat Attachment for GPR400		€ 549.00

	DIP HANDLES FOR GPR400 (PAIR)		SPECIFICATIONS
	ITEM#: GPRDH Weight: 5.5 kg Dimensions: L 31.7 x W 34.6 x H 15 cm Warranty: 6 Months		<ul style="list-style-type: none"> Attaches easily to the inside of the power rack
GPRDH	Body-Solid Dip Handels for GPR400 (Pair)		€ 69.00

	T-BAR ROW ATTACHMENT FOR GPR400		SPECIFICATIONS
	ITEM#: GPRTBR Weight: 1.5 kg Dimensions: L 25.7 x W 9 x H 6.2 cm Warranty: 6 Months		<ul style="list-style-type: none"> For use with Olympic bars Features a full 360-degree swivel
GPRTBR	Body-Solid T-Bar Row Attachment for GPR400		€ 49.00

	U-LINK ATTACHMENT FOR GPR400		SPECIFICATIONS
	ITEM#: GPRUL Weight: 2 kg Dimensions: L 22 x W 9 x H 15 cm Warranty: 6 Months		<ul style="list-style-type: none"> Increases the functionality of the Body-Solid GPR400 Power Rack Pair with Body-Solid Training Ropes Ideal storage of resistance tubes, bands and training ropes
GPRUL	Body-Solid U-Link Attachment for GPR400		€ 45.00

	WEIGHT HORN ATTACHMENT FOR GPR400		SPECIFICATIONS
	ITEM#: GPRWH	Weight: 1.9 kg	<ul style="list-style-type: none"> Organize and display weight plates Easily movable and attach to the uprights on the GPR400 Power Rack Offers easy-to-use, safe and secure weight plate and bumper plate storage
Dimensions:	L 33 x W 8 x H 15 cm		
Warranty:	6 Months		
GPRWH	Body-Solid Weight Horn Attachment for GPR400		€ 45.00

	WEIGHT MULTI CHIN-UP ATTACHMENT		SPECIFICATIONS
	ITEM#: SPRCUA	Weight: 10.6 kg	<ul style="list-style-type: none"> Each bar of the SPRCU features grip-textured, non-slip paint for safe, comfortable and effective workouts. For GPR400 and SPR1000
Dimensions:	L 107.5 x W 40 x H 16.4 cm		
Warranty:	6 Months		
SPRCUA	Body-Solid Multi Chin-Up Attachment for GPR400 and SPR1000		€ 249.00

	WEIGHT STACK ADD-ON-KIT		SPECIFICATIONS
	ITEM#: SP150	Weight: 67.5 kg (15 x 4,5 kg)	<ul style="list-style-type: none"> Takes the standard weight stack to a new level of performance. Fast and simple installation make this a must-have for your plate load system.
Dimensions:			
Warranty:	Parts: 2 years		
SP150	Weight Stack Add-On-Kit 67.5 kg		€ 390.00

	POWERLINE HALF RACK		SPECIFICATIONS
	ITEM#: PPR500	Weight: 51.1 kg	<ul style="list-style-type: none"> Customize and expand with attachments Includes J-cups and safety spotter arms 5 x 5 cm heavy gauge steel frame 5 cm hole spacing for j-cups and safety spotter arms <p>More info on page 63</p>
Dimensions:	L 127.6 x W 129.3 x H 210.8 cm		
Warranty:	Frame: 10 years - Parts: 2 years		
PPR500	Powerline Half Rack		€ 495.00
OPTIONAL			
PPR500EXT	Powerline Half Rack Extension		€ 169.00

	POWERLINE HALF RACK EXTENSION		SPECIFICATIONS
	ITEM#: PPR500EXT	Weight: 17.6 kg	<ul style="list-style-type: none"> Optional attachment for PPR500 half rack Extends PPR500 half rack without increased footprint Additional space for optional attachments 5 x 5 cm heavy gauge steel frame <p>More info on page 63</p>
Dimensions:	(Attached): L 127.6 x W 129.3 x H 210.8		
Warranty:	Frame: 10 years - Parts: 2 years		
PPR500EXT	Powerline Half Rack Extension		€ 169.00

	POWERLINE POWER RACK		SPECIFICATIONS
	ITEM#: PPR1000	Weight: 76.2 kg	<ul style="list-style-type: none"> High-quality power rack Customize and expand with attachments Includes J-cups and pipe & pin safeties 5 x 5 cm heavy gauge steel frame 5 cm hole spacing for j-cups and pin & pipe safeties Weight capacity: 300 kg <p>More info on page 63</p>
Dimensions:	L 135.8 x W 129.3 x H 210.8 cm		
Warranty:	Frame: 10 years - Parts: 2 years		
PPR1000	Powerline PowerRack		€ 750.00
OPTIONAL			
PPR1000EXT	Powerline Rack Extension for PPR1000		€ 225.00

	POWERLINE RACK EXTENSION		SPECIFICATIONS
	ITEM#: PPR1000EXT	Weight: 22 kg	<ul style="list-style-type: none"> Optional attachment for PPR500 half rack Extends PPR500 half rack without increased footprint Additional space for optional attachments 5 x 5 cm heavy gauge steel frame <p>More info on page 63</p>
Dimensions:	(Attached): L 178 x W 129.3 x H 210.8		
Warranty:	Frame: 10 years - Parts: 2 years		
PPR1000EXT	Powerline Half Rack Extension		€ 225.00

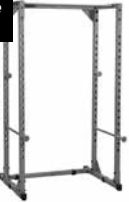
	POWERLINE POWER RACK	SPECIFICATIONS
	ITEM#: PPR200X Weight: 60.6 kg Dimensions: L 113 x W 118.6 x H 208.3 cm Warranty: Frame: 10 years - Parts: 2 years	<ul style="list-style-type: none"> • 18 Start / Stop Positions • Wide Walk-in Design • Includes 2 heat-tempered Lift Offs and 2 Saber style Safety Rods
PPR200X	Powerline Power Rack	€ 549.00
OPTIONAL ATTACHMENTS		
PLA200X	Lat Attachment	€ 349.00
DR100	Dip Attachment for PPR200 & BRPR100	€ 119.00
SCB26	Squat / Calf Block	€ 149.00

	POWERLINE LAT ATTACHMENT FOR PPR200	SPECIFICATIONS
	ITEM#: PLA200X Weight: 23 kg Dimensions: N/A Warranty: Frame: 10 years - Parts: 2 years	<ul style="list-style-type: none"> • 18 Start / Stop Positions • Wide Walk-in Design • Includes 2 heat-tempered Lift Offs and 2 Saber style Safety Rods
PLA200X	Powerline Lat Attachment for PPR200X	€ 349.00
OPTIONAL ATTACHMENTS		
OAS8	OPTIONAL 20 cm Olympic Adapter Sleeve	€ 12.00
OAS14	OPTIONAL 35 cm Olympic Adapter Sleeve	€ 20.00



	BEST FITNESS POWER RACK	SPECIFICATIONS
	ITEM#: BFPR100 Weight: 50 kg Dimensions: L 15 x W 119.6 x H 209 cm Warranty: Frame: 10 years - Parts: 2 years	<ul style="list-style-type: none"> • 18 Start / Stop Positions • Wide Walk-in Design • Includes 2 heat-tempered Lift Offs and 2 Saber style Safety Rods
BFPR100	Best Fitness Lat Attachment for PPR200X	€ 575.00
OPTIONAL ATTACHMENTS		
DR100	Dip Attachment for PPR200 & BRPR100	€ 119.00
SCB26	Squat / Calf Block	€ 135.00



	DIP ATTACHMENT FOR POWER RACKS	SPECIFICATIONS
	ITEM#: DR100 Weight: 7.4 kg Dimensions: L 58.5 x W 116 x H 7.5 cm Warranty: Frame: lifetime - Parts: 2 years	<ul style="list-style-type: none"> • Develop stronger shoulders and arms • Attachable to PPR200 and BFPR100R Power Racks • Spans both safeties for stability • Tapered handles ensure proper fit for any size user • Adjustable to several starting positions
DR100	Body-Solid Dip Attachment for PPR200X & BFPR100	€ 119.00



	POWERLINE SQUAT RACK	SPECIFICATIONS
	ITEM#: PSS60X Weight: 23 kg Dimensions: L 90.6 x W 117.2 x H 152.4 cm Warranty: Frame: 10 years - Parts: 2 years	<ul style="list-style-type: none"> • Adjustable height from 76 to 152 cm • Wide & deep base for extra stability
PSS60X	Powerline Squat Rack	Weights & clips not included € 229.00
OPTIONAL ATTACHMENTS		
PFID130X	Powerline Flat Incline Decline Bench	€ 229.00
GLDA1	Leg Developer Attachment	€ 129.00
GPCA1	Preacher Curl Attachment	€ 129.00



	BEST FITNESS MULTI-PRESS STAND	PACKAGE INCLUDES
	ITEM#: BFPR10 Weight: 30.5 kg Dimensions: L 75 x W 114.3 x H 143.5 cm Warranty: Frame: 10 years - Parts: 2 years	<ul style="list-style-type: none"> • 5 x 5 cm mainframe design • Adjustable space saving design • For doing Flat, Incline and Decline Bench Presses, Squats, Curls, Upright Rows, Shrugs, Calf Raises and much more • Color: Red
BFPR10	Best Fitness Olympic Multi-Press Stand	Weights & clips not included € 295.00



	POWERLINE MULTI-PRESS RACK		SPECIFICATIONS
	ITEM#: PMP150 Weight: 40 kg Dimensions: L 116 x W 152.8 x H 181 cm Warranty: Frame: 10 years - Parts: 2 years		<ul style="list-style-type: none"> • Heavy-duty 5 x 5 cm steel mainframe • Adjustable lift-offs and over-sized safeties • Olympic weight storage posts • 7° reverse pitch accommodates natural lifting paths • Perform squats, shoulder presses, bench presses & more
PMP150	Powerline Multi-Press Rack		€ 395.00
OPTIONAL ATTACHMENTS			
PFID130X	Powerline Flat Incline Decline Bench		€ 229.00
PFID125X	Powerline Multi-Bench		€ 245.00

	PRO CLUBLINE COMMERCIAL SQUAT RACK		SPECIFICATIONS
	ITEM#: SPR250 Weight: 64 kg Dimensions: L 130 x W 151 x H 184.6 cm Warranty: In-Home Lifetime / Light Commercial (P. 119)		<ul style="list-style-type: none"> • Adjustable frame fits 150, 180 and 210 cm Olympic bars • 5 x 7.5 cm 11-gauge steel • 5 cm hole spacing for optional safety spotters • Includes 2 premium J-cup liftoffs • Weight Capacity: 450 kg
SPR250	Pro Clubline Commercial Squat Rack		€ 595.00



	MULTI-PRESS RACK (WITH SAFETIES & HORNS)		SPECIFICATIONS
	ITEM#: GPR370 Weight: 63.7 kg Dimensions: L 114.3 x W 162.5 x H 188 cm Warranty: In-Home Lifetime / Light Commercial (P. 119)		<ul style="list-style-type: none"> • 17° Reverse Pitch Design • 11 Gauge 5X7.6 cm Construction • 14-Position Gunrack & Safeties • 4 Olympic Weight Plate Storage Posts
GPR370	Body-Solid Olympic Multi-Press Rack - Ø 50 mm	Weights & clips not included	€ 679.00
GPR370-25S	Body-Solid Standard Multi-Press Rack - Ø 25/28/30 mm		€ 679.00
OPTIONAL ATTACHMENTS			
GFID71	Flat • Incline • Decline Bench for home or commercial use		€ 495.00
GLDA3	Leg Developer Station - 6 roller		€ 129.00
GPCA1	Preacher Curl Station		€ 129.00



	BENCH RACK COMBO		SPECIFICATIONS
	ITEM#: SDIB370 Weight: 97.52 kg Dimensions: L 179.3 x W 166.3 x H 188 cm Warranty: In-Home Lifetime (P. 119)		<ul style="list-style-type: none"> • Extra-wide 4-point stance / 7° reverse pitch • Lift-off and safety positions • 450 kg Weight capacity • 5 x 7.6 cm, 11-gauge steel • Thick durable upholstery • Oversized wheels with a front transport handle
SDIB370	Body-Solid Bench Rack Combo	Weights & clips not included	€ 1274.00
PACKAGE INCLUDES			
GPR370	Multi-Press Rack with safeties & Horns		€ 679.00
SFID325	Flat / Incline / Decline Bench		€ 595.00



 	POWERLINE OLYMPIC INCLINE / FLAT BENCH		SPECIFICATIONS
	ITEM#: POB44X Weight: 38 kg Dimensions: L 130 x W 114 x H 178 cm - Ø 25 mm Warranty: Frame: 10 years - Parts: 2 years		<ul style="list-style-type: none"> Adjustable from flat to incline Military press Comfortable padding Wide stable base. Optional barbell must have at least a length of 120cm
POB44X	Powerline Olympic Incline / Flat Bench	Weights & clips not included	€ 375.00

 	BEST FITNESS OLYMPIC FOLDING BENCH		SPECIFICATIONS
	ITEM#: BFOB10 Weight: 32.1 kg Dimensions: L 172.7 x W 104 x H 147.3 cm Warranty: Frame: 10 years - Parts: 2 years		<ul style="list-style-type: none"> Adjustable from flat to incline Adjustable Uprights Adjustable space saving design Fold Up Storage position Color: Red
BFOB10	Best Fitness Olympic Bench		€ 389.00
OPTIONAL ATTACHMENTS			
OAS8	OPTIONAL 20 cm Olympic Adapter Sleeve		€ 12.00
OAS14	OPTIONAL 35 cm Olympic Adapter Sleeve		€ 20.00

	POWERCENTER COMBO BENCH		SPECIFICATIONS
	ITEM#: GDIB46L Weight: 50 kg Dimensions: L 195.5 x W 116.8 x H 109.2 cm Warranty: In-Home Lifetime / Light Commercial (P. 119)		<ul style="list-style-type: none"> Includes leg developer 6-Position flat / incline / decline DuraFirm™ back and seat pads
GDIB46L	Body-Solid Combo Bench	Weights & clips not included	€ 499.00
OPTIONAL ATTACHMENTS			
GLRA81	Lat Pulldown•Seated Row Station for GDIB46L & GFID71		€ 239.00
GPCA1	Preacher Curl Station		€ 129.00
OAS8	OPTIONAL 20 cm Olympic Adapter Sleeve		€ 12.00
OAS14	OPTIONAL 35 cm Olympic Adapter Sleeve		€ 20.00

	PRO CLUBLINE DECLINE OLYMPIC BENCH		SPECIFICATIONS
	ITEM#: SODB250 Weight: 67 kg Dimensions: L 146 x W 126 x H 138 cm Warranty: In-Home Lifetime / Light Commercial (P. 119)		<ul style="list-style-type: none"> Weight capacity: 450 kg Ideal for decline bench presses and other chest press movements -18° Backrest angle Adjustable leg hold positions
SODB250	Pro Clubline decline Olympic bench		€ 795.00

	PRO CLUBLINE FLAT OLYMPIC BENCH		SPECIFICATIONS
	ITEM#: SOFB250 Weight: 74.5 kg Dimensions: L 184 x W 126 x H 130 cm Warranty: In-Home Lifetime / Light Commercial (P. 119)		<ul style="list-style-type: none"> Spotter Stand included Durable double-stitched upholstery Backpad is 445 mm off the ground Backpad Width: 292 mm Weight capacity: 450 kg
SOFB250	Pro Clubline flat Olympic bench		€ 750.00

	PRO CLUBLINE INCLINE OLYMPIC BENCH		SPECIFICATIONS
	ITEM#: SOIB250 Weight: 79 kg Dimensions: L 187.4 x W 127 x H 159 cm Warranty: In-Home Lifetime / Light Commercial (P. 119)		<ul style="list-style-type: none"> 30° backrest angle and adjustable seat pad Durable double-stitched upholstery Spotter Stand included Backpad Width: 292 mm Heavy-duty 11-gauge mainframe Weight Capacity: 450 kg
SOIB250	Pro Clubline incline Olympic bench		€ 895.00

	PRO CLUBLINE SHOULDER OLYMPIC BENCH		SPECIFICATIONS
	ITEM#: SOSB250	FC FULL COMMERCIAL RATED	<ul style="list-style-type: none"> • Safe and effective shoulder press movements • Durable double-stitched upholstery • Spotter Stand included • Heavy-duty 11-gauge mainframe • Weight Capacity: 450 kg
	Weight: 122.5 kg		
	Dimensions: L 125.7 x W 126 x H 183.5 cm		
	Warranty: In-Home Lifetime / Light Commercial (P. 119)		
SOSB250	Pro Clubline Shoulder Olympic bench		€ 1195.00

	BEST FITNESS FID FOLDING BENCH		SPECIFICATIONS
	ITEM#: BFFID10		<ul style="list-style-type: none"> • 4 position from 0 to 90 ° • Fold up design • Fully assembled in box • Perfect for dumbbell exercises • Color: Red
	Weight: 16 kg		
	Dimensions: L 162.5 x W 56 x H 116.8 cm		
	Warranty: Frame: 10 years - Parts: 2 years		
BFFID10	Best Fitness FID Folding Bench		€ 245.00



	BEST FITNESS FOLDING BENCH		SPECIFICATIONS
	ITEM#: BFFID25		<ul style="list-style-type: none"> • Fully assembled out of the box • Ladder-style back pad adjustments • Folds for easy storage (22 cm H) • Weight Capacity: 200 kg
	Weight: 15.4 kg		
	Dimensions: L 144.8 x W 38 x H 45.7 cm		
	Warranty: Frame: 10 years - Parts: 2 years		
BFFID25	Best Fitness Folding Bench		€ 199.00



	FLAT BENCH		SPECIFICATIONS
	ITEM#: GFB350	C COMMERCIAL RATED	<ul style="list-style-type: none"> • Perfect for barbell and dumbbell exercises • 5 x 7.6 cm heavy gauge steel mainframe • Wide base eliminates rocking
	Weight: 19 kg		
	Dimensions: L 116.8 x W 58.4 x H 50.8 cm		
	Warranty: In-Home Lifetime / Light Commercial (P. 119)		
GFB350	Body-Solid Flat Bench		€ 219.00



	UTILITY STOOL		SPECIFICATIONS
	ITEM#: GST20	C COMMERCIAL RATED	<ul style="list-style-type: none"> • Ideal for performing barbell and dumbbell workouts • Extra wide & solid base provides maximum stability • Extra thick & double-stitched DuraFirm™ upholstery
	Weight: 13.5 kg		
	Dimensions: L 71.1 x W 71.1 x H 116.8 cm		
	Warranty: In-Home Lifetime / Light Commercial (P. 119)		
GST20	Body-Solid Utility Stool		€ 229.00



	POWERLINE FLAT / INCLINE / DECLINE BENCH		SPECIFICATIONS
	ITEM#: PFID130X		<ul style="list-style-type: none"> • Fully adjustable from decline to shoulder press positions • T-Bar Leg Hold Down included • Optional Leg Developer
	Weight: 21.8 kg		
	Dimensions: L 140 x W 67 x H 52 cm		
	Warranty: Frame: 10 years - Parts: 2 years		
PFID130X	Powerline Flat/Incline/Decline Bench with Leg Hold down		€ 229.00
	OPTIONAL ATTACHMENTS		
GLDA1	Leg Developer Attachment		€ 129.00
GPCA1	Preacher Attachment		€ 129.00



	POWERLINE FLAT / INCLINE / DECLINE BENCH		SPECIFICATIONS
	ITEM#: PFID125X		<ul style="list-style-type: none"> • Folding flat / incline / decline bench • No assembly required • 7 position adjustment
	Weight: 20.4 kg		
	Dimensions: L 150 x W 47.5 x H 44 cm		
	Warranty: Frame: 10 years - Parts: 2 years		
PFID125X	Powerline Flat / Incline / Decline Bench		€ 289.00



	FLAT / INCLINE BENCH		SPECIFICATIONS
	ITEM#: GF121	Weight: 26 kg Dimensions: L 132 x W 53.4 x H 43.2 - 116.8 cm Warranty: In-Home Lifetime / Light Commercial (P. 119)	 <ul style="list-style-type: none"> • 5 x 7.6 cm heavy gauge steel mainframe • "Glide & Lock" seat & back pad adjustment system • Adjusts from flat to 90° in 9 positions
GF121	Body-Solid Flat / Incline Bench		€ 345.00

	FLAT / INCLINE / DECLINE BENCH		SPECIFICATIONS
	ITEM#: GFID100	Weight: 24 kg Dimensions: L 168.2 x W 70.4 x H 48.5 cm Warranty: In-Home Lifetime / Light Commercial (P. 119)	 <ul style="list-style-type: none"> • 15-Position seat / back pads adjust from decline to 90° • Ideal for use with Power Rack and Smith Machines • T-Bar Leg Hold Down included • Includes Bent Knee Ab-Board Function • Color: Red
GFID100	Body-Solid Flat / Incline / Decline Bench		€ 345.00
OPTIONAL ATTACHMENTS			
GPCA1	Preacher Curl Station for GDIB46L, GFID31, GFID71		€ 129.00
GLDA3	Leg Developer Station - 4 Rollers for GFID71 & GFID100		€ 129.00

	FULLY ASSEMBLED FOLDING BENCH		SPECIFICATIONS
	ITEM#: GFID225	Weight: 24 kg Dimensions: L 147.8 x W 40.6 x H 45.7 cm Warranty: In-Home Lifetime / Light Commercial (P. 119)	 <ul style="list-style-type: none"> • Folding flat / incline / decline bench • No assembly required • 7 position adjustment • 5 x 7.6 cm heavy gauge oval steel mainframe • Thick DuraFirm™ padding
GFID225	Body-Solid Folding Flat/Incline/Decline Bench fully assembled		€ 349.00

	FLAT / INCLINE / DECLINE BENCH		SPECIFICATIONS
	ITEM#: GFID31	Weight: 26 kg Dimensions: L 150 x W 68.5 x H 55.9 cm Warranty: In-Home Lifetime	 <ul style="list-style-type: none"> • 15-Position seat and back pads from decline to 90° • Ideal for use with Power Rack & Smith Machines • T-Bar Leg Hold down included • Includes Bent Knee Ab-Board Function
GFID31	Body-Solid Flat/Incline/Decline Bench with Leg Hold Down		€ 385.00
OPTIONAL ATTACHMENTS			
GPCA1	Preacher Curl Station for GDIB46L, GFID31, GFID71		€ 129.00
GLDA1	Leg Developer Station - 4 Rollers for GFID31		€ 129.00

	FLAT / INCLINE / DECLINE BENCH		SPECIFICATIONS
	ITEM#: GFID71	Weight: 45.5 kg Dimensions: L 177.8 x W 71 x H 48.2 cm Warranty: In-Home Lifetime / Light Commercial (P. 119)	 <ul style="list-style-type: none"> • 5 x 7.6 cm construction • Thick DuraFirm™ seat and back pad • 8-Position seat and back pads adjust from decline to 90°
GFID71	Body-Solid Flat/Incline/Decline Bench with Leg Hold Down		€ 495.00
OPTIONAL ATTACHMENTS			
GPCA1	Preacher Curl Station for GDIB46L, GFID31, GFID71		€ 129.00
GLDA3	Leg Developer Station - 4 Rollers for GFID71 & GFID100		€ 129.00
GLRA81	Lat Pulldown / Seated Row for GDIB46L, GFID71		€ 239.00

	OLYMPIC LEVERAGE FLAT INCLINE DECLINE BENCH		SPECIFICATIONS
	ITEM#: FID46	Weight: 42.2 kg Dimensions: L 183 x W 71 x H 78.7 cm Warranty: In-Home Lifetime / Light Commercial (P. 119)	 <ul style="list-style-type: none"> • Synchronized seat and back pad adjustments • Includes leg developer • Transport wheels for easy movement • Back pad adjusts to -20° to 0° to 70° • Seat pad adjusts to 0°, 4°, 6°, 8°, 10°, 12°, 15° and 17° • Weight Capacity: 270 kg
FID46	Body-Solid Olympic Leverage Flat Incline Decline Bench		€ 575.00

	PRO CLUBLINE FLAT BENCH		SPECIFICATIONS
	ITEM#: SFB125	FC FULL COMMERCIAL RATED	<ul style="list-style-type: none"> 5 x 7.5 cm 11-gauge steel construction High-density foam Attached transport wheels Pad dimensions: L 122 x W 30.5 cm Weight capacity: 680 kg
SFB125	Pro Clubline Flat Bench		€ 385.00

	PRO CLUBLINE INCLINE/DECLINE FLAT BENCH		SPECIFICATIONS
	ITEM#: SFID325	FC FULL COMMERCIAL RATED	<ul style="list-style-type: none"> 5x7.6 cm eleven-gauge steel 450 kg capacity Back pad adjusts flat, incline (15, 30, 45, 60 & 80 °) decline (-18 °) Seat pad adjusts flat, 10, and 18 ° Independent back pad and seat pad adj. Color: steel grey & black upholstery
SFID325	Pro Clubline Flat / Incline / Decline Bench		€ 595.00



	PRO CLUBLINE INCLINE/DECLINE FLAT BENCH		SPECIFICATIONS
	ITEM#: SFID325B	FC FULL COMMERCIAL RATED	<ul style="list-style-type: none"> 5x7.6 cm 11-gauge steel 450 kg capacity Back pad adjusts flat, incline (15, 30, 45, 60 & 80 °) decline (-18 °) Seat pad adjusts flat, 10, and 18 ° Independent back pad and seat pad adj. Color: black
SFID325B	Pro Clubline Flat / Incline / Decline Bench		€ 595.00



	PRO CLUBLINE ADJUSTABLE BENCH		SPECIFICATIONS
	ITEM#: SFID425	FC FULL COMMERCIAL RATED	<ul style="list-style-type: none"> 450 kg capacity Back pad adjusts flat, incline (15, 30, 45, 60 and 80 °) and decline (-18 °) Seat pad adjusts flat, 10, and 18 ° Leg hold down to perform decline presses, sit-ups and more
SFID425	Pro Clubline Flat / Incline / Decline Bench		€ 635.00



	LEG DEVELOPER ATTACHMENT		SPECIFICATIONS
	ITEM#: GLDA1	C COMMERCIAL RATED	<ul style="list-style-type: none"> Leg Extensions are designed for ultimate strengthening of the Knee and Thigh muscles. Leg Curls for maximum concentration of Hamstring and Glute muscles. For standard plates 25 mm
GLDA1	Leg Developer Attachment		€ 129.00
OPTIONAL ATTACHMENTS			
OAS8	OPTIONAL 20 cm Olympic Adapter Sleeve		€ 12.00



	LEG DEVELOPER 6 ROLLERS		SPECIFICATIONS
	ITEM#: GLDA3	C COMMERCIAL RATED	<ul style="list-style-type: none"> Leg Extensions are designed for ultimate strengthening of the Knee and Thigh muscles. Leg Curls for maximum concentration of Hamstring and Glute muscles. Features the ability to lock the pivot creating a leg hold down for lat pulldowns and ab crunches. For standard plates 25 mm
GLDA3	Leg Developer Station - 6 rollers		€ 129.00
OPTIONAL ATTACHMENTS			
OAS8	OPTIONAL 20 cm Olympic Adapter Sleeve		€ 12.00



	PREACHER CURL STATION		SPECIFICATIONS
	ITEM#: GPCA1	C COMMERCIAL RATED	<ul style="list-style-type: none"> Designed to isolate and maximize Biceps, Triceps and Forearm muscle concentration. Extra-thick, DuraFirm™ pad. Bar saddle included. Cannot be used independently. For use with #GFID71, #GFID31, #GDIB46L, #GFID100 only
GPCA1	Preacher Curl Station		€ 129.00



	LAT ATTACHMENT FOR GDIB46L/GFID71		SPECIFICATIONS	
	ITEM#: GLRA81	Weight: 14 kg		<ul style="list-style-type: none"> • High & Low Pulleys for back, arm and shoulder muscles. • High strength nylon coated cable (aircraft quality 995 kg test) • Includes Lat Bar, Low Row Bar and two cables. 211 cm high attached to bench. • For use with GDIB46L and GFID71 benches only
Dimensions: L 68.8 x W 111.5 x H 205.7 cm	Warranty: In-Home Lifetime / Light Commercial (P. 119)			
GLRA81	Body-Solid Lat attachment for GDIB46L/GFID71	€ 239.00		



	DIP STATION		SPECIFICATIONS	
	ITEM#: GDIP59	Weight: 20.2 kg		<ul style="list-style-type: none"> • 5 x 7.6 cm steel mainframe • Angled Uprights for all size users • Oversized bars with slip-proof rubber grip • Wide and extended base eliminates rocking • Distance between dip handles 48 cm at base to 53 cm at end
Dimensions: L 86.5 x W 68.5 x H 134.6 cm	Warranty: In-Home Lifetime / Light Commercial (P. 119)			
GDIP59	Body-Solid Dip Station	€ 319.00		



	SEATED ROW MACHINE		SPECIFICATIONS	
	ITEM#: GSRM40	Weight: 36.8 kg		<ul style="list-style-type: none"> • DuraFirm™ chest and seat pads • Easy access plate load system • Oil-lite bronze bushings at all pivot points • Extra-thick foam padded foot braces • Ideal for home and commercial use
Dimensions: L 137 x W 111.7 x H 99 cm	Warranty: In-Home Lifetime / Light Commercial (P. 119)			
GSRM40	Body-Solid Seated Row Machine	Weights & clips not included		
OPTIONAL ATTACHMENTS				
OAS8	OPTIONAL 20 cm Olympic Adapter Sleeve			€ 12.00
OAS14	OPTIONAL 35 cm Olympic Adapter Sleeve			€ 20.00



	PLATE LOADED PEC MACHINE		SPECIFICATIONS	
	ITEM#: GPM65	Weight: 41.3 kg		<ul style="list-style-type: none"> • 5 x 5 cm steel mainframe • Extra-thick & super tough DuraFirm™ padding • Articulating arms for unilateral and bilateral chest development • Fully adjustable to accommodate any size user
Dimensions: L 100 x W 175.2 x H 167 cm	Warranty: In-Home Lifetime / Light Commercial (P. 119)			
GPM65	Body-Solid Plate Loaded Pec Machine	€ 625.00		
OPTIONAL ATTACHMENTS				
OAS8	OPTIONAL 20 cm Olympic Adapter Sleeve			€ 12.00
OAS14	OPTIONAL 35 cm Olympic Adapter Sleeve			€ 20.00



 	BEST FITNESS CABLE CROSSOVER		SPECIFICATIONS
	ITEM#: BFCC010 Weight: 46.3 kg Dimensions: L 94 x W 279.5 x H 210.8 cm Warranty: Frame: 10 years - Parts: 2 years		<ul style="list-style-type: none"> • Designed for use in home and garage gyms • No cable change design • 180-degree swiveling pulleys • Nylon bushings & chrome guide rods
BFCC010	Body-Solid Cable Crossover		€ 599.00



 	POWERLINE CABLE CROSSOVER MACHINE		SPECIFICATIONS
	ITEM#: PCC090X Weight: 42 kg Dimensions: L 286 x W 93 x H 211.4 cm Warranty: Frame: 10 years - Parts: 2 years		<ul style="list-style-type: none"> • Top & Bottom pulleys swivel smoothly through a 180° range of motion • Carriage system travels on nylon bushings • Includes 2 cable handles and 1 ankle strap
PCC090X	Powerline Cable Crossover Machine		€ 699.00
OPTIONAL ATTACHMENTS			
GCA2	Lat pull-up / Chin-up Handles		€ 50.00
OAS8	OPTIONAL 20 cm Olympic Adapter Sleeve		€ 12.00
OAS14	OPTIONAL 35 cm Olympic Adapter Sleeve		€ 20.00

	CABLE CROSSOVER 2 X 75 KG		SPECIFICATIONS
	ITEM#: GCC0150 Weight: 217 kg Dimensions: L 355 x W 211 x H 210.8 cm Warranty: In-Home Lifetime / Light Commercial (P. 119)		 <ul style="list-style-type: none"> • Large pulleys for smooth movement 180° in all directions • 10 x high/low pulley adjustments • Height adjustable draw (11 levels) • Supplied with 2 x stirrup handles and 1 x ankle strap
GCC0150	Body-Solid Cable Crossover Machine		€ 1895.00
OPTIONAL ATTACHMENTS			
GCA2	Optional Lat Pull-Up / Chin-Up Station		€ 59.00

	FUNCTIONAL TRAINING CENTER		SPECIFICATIONS
	ITEM#: GDCC250 Weight: 254.8 kg Dimensions: L 416.5 x W 73.6 x H 212 cm Warranty: In-Home Lifetime / Light Commercial (P. 119)		 <ul style="list-style-type: none"> • Includes 2 72.5 Kg weight stack / 295 kg weight stack available • Vertically adjustable pulleys • Traveling pulleys swivel smoothly through a 180° range of motion • Large oval tubing
GDCC250	Body-Solid Functional Training Center		€ 2295.00
OPTIONAL ATTACHMENTS			
SP50	Optional 22.5 kg Selectorized Weight Stack Upgrade (Requires 2)		€ 130.00

	PRO CLUBLINE CABLE CROSSOVER		SPECIFICATIONS
	ITEM#: SCC1200G Weight: 305.2 kg Dimensions: L 396.2 x W 90 x H 231 cm Warranty: In-Home Lifetime / Full Commercial (P. 119)		 <ul style="list-style-type: none"> • 5 X 10 cm steel mainframe • Independent weight stacks • Fully adjustable pivoting pulleys
SCC1200G-1	Pro Clubline Cable Crossover 75 kg Weight Stack		€ 4695.00
SCC1200G-2	Pro Clubline Cable Crossover 105 kg Weight Stack		€ 4895.00
OPTIONAL ATTACHMENTS			
GCA2	Optional Lat Pull-Up / Chin-Up Station		€ 59.00

	OPTIONAL PULL-UP/ CHIN-UP HANDLES		SPECIFICATIONS
	ITEM#: GCA2 Weight: 3.5 kg Dimensions: N/A Warranty: In-Home Lifetime / Full Commercial (P. 119)		 <ul style="list-style-type: none"> • Lat Pull Up Chin Up Station • Features lock down dual grips with infinite variable width spacing that allows full extension and contraction when doing chin ups and lat pull ups. • For use with PCC090X cable crossover only.
GCA2	Body-Solid Optional Pull Up / Chin Up Handles		€ 59.00



PRO CLUBLINE SERIES II CROSS OVER		SPECIFICATIONS
	ITEM#: S2CCO Weight: 446 kg Dimensions: L 486 x W 146.3 x H 251.5 cm Warranty: In-Home Lifetime / Full Commercial (P. 119)	 <ul style="list-style-type: none"> • 36 starting positions for both weight stacks • Integrated multi grip chinning bar • Fully shrouded • 2 x 72.5, 95 or 140 kg weight stacks available • Includes: 2 nylon cable handles, ankle strap and straight bar
	S2CCO-1 Pro Clubline II Cable Crossover Machine / 72.5 kg weight stack € 7495.00	
S2CCO-2 Pro Clubline II Cable Crossover Machine / 95 kg weight stack € 7595.00		



WEIGHT STACK ADD-ON-KIT		SPECIFICATIONS
	ITEM#: SP50 Weight: 22.5 kg Dimensions: N/A Warranty: Parts: 2 years	<ul style="list-style-type: none"> • Takes the standard weight stack to a new level of performance. • Fast and simple installation make this a must-have for your plate load system.
	SP50 Weight Stack Add-On-Kit 22.5 kg € 130.00	



BEST FITNESS FUNCTIONAL TRAINER		SPECIFICATIONS
	ITEM#: BFFT10 Weight: 140.5 kg Dimensions: L 139.7 x W 155 x H 213 cm Warranty: Frame: 10 years - Parts: 2 years	<ul style="list-style-type: none"> • Smaller Functional Trainer Footprint • 19 vertical pulley adjustments • Single 85 kg weight stack • Integrated Straight Chinning Bar • Color: Red
	BFFT10 Best Fitness Functional Trainer € 1095.00	



POWERLINE FUNCTIONAL TRAINER 95KG		SPECIFICATIONS
	ITEM#: PFT50 Weight: 149.3 kg Dimensions: L 139.7 x W 155 x H 213 cm Warranty: Frame: 10 years - Parts: 2 years	<ul style="list-style-type: none"> • Compact and versatile • Fully adjustable 180° swivel pulleys • 95 kg weight stack • No cable change design • Includes two nylon cable handles • Integrated straight chin-up bar
	PFT50 Powerline Functional Trainer 95 kg € 1395.00	



POWERLINE FUNCTIONAL TRAINER		SPECIFICATIONS
	ITEM#: PFT100 Weight: 216 kg Dimensions: L 159 x W 107.5 x H 210.8 cm Warranty: Frame: 10 years - Parts: 2 years	<ul style="list-style-type: none"> • 2 x 72.5 kg weight stacks • Vertically adjustable pulleys • Pulleys 180° range of motion • ½ to 1 weight ratio • Chinning bar included Integrated accessory bar storage
	PFT100 Powerline Functional Trainer € 1645.00	
OPTIONAL ATTACHMENTS		
SP50 Optional 22.5 kg Selectorized Weight Stack Upgrade (Requires 2) € 130.00		
GDCCBAR GDCC Bar € 39.00		



PREMIUM FUNCTIONAL TRAINER		SPECIFICATIONS
	ITEM#: GFT100 Weight: 287 kg Dimensions: L 114.5 x W 162.5 x H 210.8 cm Warranty: In-Home Lifetime / Light Commercial (P. 119)	 <ul style="list-style-type: none"> • 2x 72.5 kg weight stacks (upgradable to 2x 95 kg or 2x 140 kg stacks) • 1:2 weight resistance ratio • 11-gauge, 50 x 76 mm steel construction • 2 fully adjustable swiveling pulleys • Integrated chinning bar • Space-saving design
	GFT100 Premium Functional Trainer 2x 72.5 kg Weight Stack (GFT100-1) € 2595.00 with 2x 95 kg Weight Stack (GFT100-2) € 2650.00 with 2x 140 kg Weight Stack (GFT100-3) € 2850.00	
GFT100C Premium Functional Trainer + 2x 75.5 kg Weight Stack + GFT100SH Stack Shrouds € 2995.00		
OPTIONAL ATTACHMENTS		
GFT100SH Weight Stack Shrouds € 400.00		



	WEIGHT STACK SHROUDS		SPECIFICATIONS	
	ITEM#: GFT100SH		<ul style="list-style-type: none"> • For GDCC200 & GDCC210 • 4 specially angled pegs for proper storage • Mounted for easy access • Inside support handle 	
Weight: 246.7 kg				
Dimensions: N/A				
Warranty: In-Home Lifetime / Light Commercial (P. 119)				
GFT100SH	Body-Solid Weight Stack Shrouds for GFT100		€ 400.00	



	FUNCTIONAL TRAINING CENTER		SPECIFICATIONS	
	ITEM#: GDCC210		<ul style="list-style-type: none"> • 2 x 72.5 kg weight stacks • Ø4.8 mm spun steel aircraft cables rated to over 1000 kg • 20 independent height adjustments and 180° cable positioning • Dual position pull-up bar 	
Weight: 223.9 kg				
Dimensions: L 147 x W 107.4 x H 212.8 cm				
Warranty: In-Home Lifetime / Light Commercial (P. 119)				
GDCC210	Body-Solid Functional Training Center		€ 2295.00	
OPTIONAL ATTACHMENTS				
SP50	Optional 22.5 kg Selectorized Weight Stack Upgrade (Requires 2)		€ 130.00	
GDCCBAR	GDCC Bar		€ 39.00	
GDCCRACK	GDCC Accessory Rack		€ 49.00	

	FUNCTIONAL TRAINING CENTER		SPECIFICATIONS	
	ITEM#: GDCC200		<ul style="list-style-type: none"> • 2 x 72.5 kg weight stacks • Ø4.8 mm spun steel aircraft cables rated to over 1000 kg • 20 independent height adjustments and 180° cable positioning • Dual position pull-up bar 	
Weight: 233.7 kg				
Dimensions: L 184.3 x W 107.3 x H 213.5 cm				
Warranty: In-Home Lifetime / Light Commercial (P. 119)				
GDCC200	Body-Solid Functional Training Center		€ 2295.00	
OPTIONAL ATTACHMENTS				
SP50	Optional 22.5 kg Selectorized Weight Stack Upgrade (Requires 2)		€ 130.00	
GDCCBAR	GDCC Bar		€ 39.00	
GDCCRACK	GDCC Accessory Rack		€ 49.00	



	GDCC ACCESSORY RACK		SPECIFICATIONS	
	ITEM#: GDCCRACK		<ul style="list-style-type: none"> • For GDCC200 & GDCC210 • 4 specially angled pegs for proper storage • Mounted for easy access • Inside support handle 	
Weight: 2 kg				
Dimensions: L 76.2 x W 25.4 x H 12.7 cm				
Warranty: In-Home Lifetime / Light Commercial (P. 119)				
GDCCRACK	Body-Solid GDCC Accessory Rack		€ 49.00	



	DUAL PRESS BAR ATTACHMENT		SPECIFICATIONS	
	ITEM#: GDCCBAR		<ul style="list-style-type: none"> • For GDCC200 & GDCC210 • Use the GDCC Bar to assist • Bench Press, Incline Press, Decline Press, Shoulder Press, Squats 	
Weight: 3.3 kg				
Dimensions: L 106.6 x W 3.8 x H 3.5 cm				
Warranty: In-Home Lifetime / Light Commercial (P. 119)				
GDCCBAR	Body-Solid Dual Press Bar Attachment		€ 39.00	

	PRO CLUBLINE II CABLE COLUMN		SPECIFICATIONS	
	ITEM#: S2CC		<ul style="list-style-type: none"> • 36 starting positions • Fully shrouded • 72.5, 95 or 140 kg weight stack available • 5 x 7.6 cm 11 Gauge Steel Frame • Includes: nylon cable handle, ankle strap and straight bar 	
Weight: 212.1 kg				
Dimensions: L 134.5 x W 146.3 x H 251.5 cm				
Warranty: In-Home Lifetime / Full Commercial (P. 119)				
S2CC-1	Pro Clubline Series II Cable Column / 75 kg weight stack		€ 3595.00	
S2CC-2	Pro Clubline Series II Cable Column / 95 kg weight stack		€ 3650.00	

PRO CLUBLINE FUNCTIONAL TRAINER		SPECIFICATIONS
	ITEM#: S2FT-1 Weight: 375.8 kg Dimensions: L 201.7 x W 137 x H 251.5 cm Warranty: In-Home Lifetime / Full Commercial (P. 119)	 <ul style="list-style-type: none"> • 34 starting positions for both weight stacks • Integrated chinning bar • 72.5, 95 or 140 kg weight stacks available • Includes 109 cm revolving straight bar, 35 cm athletic bar, 2 nylon cable handles, ankle strap and straight bar
	S2FT-1 Pro Clubline Functional Trainer with 2x 72.5 kg Weight Stack € 6450.00	
S2FT-2 Pro Clubline Functional Trainer with 2x 95 kg Weight Stack € 6650.00		

POWERLINE PREACHER CURL MACHINE		SPECIFICATIONS
	ITEM#: PPB32X Weight: 19 kg Dimensions: L 86.5 x W 89 x H 94.5 cm Warranty: Frame: 10 years - Parts: 2 years	<ul style="list-style-type: none"> • Adjustable seat and extra-wide, stable design • Heavy gauge steel construction • Extra-wide seat and arm pads • 140 kg weight capacity
	PPB32X Powerline Preacher Curl Bench € 235.00	

PREACHER CURL BENCH		SPECIFICATIONS
	ITEM#: GPCB329 Weight: 33.8 kg Dimensions: L 106 x W 77 x H 97.5 cm Warranty: In-Home Lifetime / Light Commercial (P. 119)	 <ul style="list-style-type: none"> • 5 x 7.6 cm steel mainframe • Arm pad is set to a perfect 30° angle • Extra-thick and super tough DuraFirm™ arm and seat pads • Fully adjustable to accommodate all size users • Extra-wide base and bar cradle
	GPCB329 Body-Solid Preacher Curl Bench € 425.00	

CAM SERIES BICEPS / TRICEPS MACHINE		SPECIFICATIONS
	ITEM#: GCBT380 Weight: 36 kg Dimensions: L 114.3 x W 109.2 x H 101.6 cm / Ø25 mm Warranty: In-Home Lifetime / Light Commercial (P. 119)	 <ul style="list-style-type: none"> • Thick DuraFirm™ padding • 5 x 5 cm and 5 x 10 cm steel mainframe • Positioned at a 30° angle for precise biomechanical movement • Raise or lower the adjustable seat for proper positioning
	GCBT380 Body-Solid Cam Series Biceps / Triceps Machine € 645.00	
OPTIONAL ATTACHMENTS		
OAS8	OPTIONAL 20 cm Olympic Adapter Sleeve	€ 12.00
OAS14	OPTIONAL 35 cm Olympic Adapter Sleeve	€ 20.00







POWERLINE LAT MACHINE		SPECIFICATIONS
	ITEM#: PLM180X Weight: 31.5 kg Dimensions: L 121 x W 108 x H 205.7 cm / Ø 25 mm Warranty: Frame: 10 years - Parts: 2 years	<ul style="list-style-type: none"> • Heavy gauge steel construction • Ø2.5 cm weight posts • Leg Hold Down • Lat Bar and Low Row Bar included
	PLM180X Powerline Lat Machine € 429.00	
OPTIONAL ATTACHMENTS		
OAS8	OPTIONAL 20 cm Olympic Adapter Sleeve	€ 12.00
OAS14	OPTIONAL 35 cm Olympic Adapter Sleeve	€ 20.00

PLATE LOADED LAT MACHINE		SPECIFICATIONS
	ITEM#: GLM83 Weight: 45.8 kg Dimensions: L 152.4 x W 81.2 x H 208.2 cm / Ø25 mm Warranty: In-Home Lifetime / Light Commercial (P. 119)	 <ul style="list-style-type: none"> • No cable change between the high and low pulleys • DuraFirm™ pads • Oversize adjustable foam rollers • Includes Lat Bar and Straight Bar
	GLM83 Body-Solid Plate Loaded Lat Machine € 595.00	
OPTIONAL ATTACHMENTS		
OAS8	OPTIONAL 20 cm Olympic Adapter Sleeve	€ 12.00
OAS14	OPTIONAL 35 cm Olympic Adapter Sleeve	€ 20.00

	PLATE LOADED LAT MACHINE WITH 95 KG		SPECIFICATIONS
	ITEM#: GLM84	Weight: 45.8 kg	<ul style="list-style-type: none"> No cable change between the high and low pulleys DuraFirm™ pads Oversize adjustable foam rollers Includes Lat Bar and Straight Bar
Dimensions:	L 152.4 x W 81.2 x H 208.2 cm / Ø25 mm		
Warranty:	In-Home Lifetime / Light Commercial (P. 119)		
GLM84	Body-Solid Plate Loaded Lat Machine with 95 kg		€ 1195.00
GLM84-3	Body-Solid Plate Loaded Lat Machine with 140 kg		€ 1345.00

	BEST FITNESS FOLDING AB		SPECIFICATIONS
	ITEM#: BFAB10	Weight: 11 kg	<ul style="list-style-type: none"> Adjustable and foldable Effective in isolating the entire abdominal region Comfortable foam rollers keep you locked into position Long back pad accommodates even the tallest user Color: red
Dimensions:	L 106.7 x W 45.7 x H 58.4 cm		
Warranty:	Frame: 10 years - Parts: 2 years		
BFAB10	Best Fitness Folding Ab Board		€ 199.00

	BEST FITNESS SEMI RECUMBENT AB BENCH		SPECIFICATIONS
	ITEM#: BFAB20	Weight: 27.5 kg	<ul style="list-style-type: none"> Heavy gauge steel mainframe Seat adjustment Isolates upper and lower abs Resistance and assistance weight post Optional OA8 (20 cm Olympic adaptor sleeve) & oas14 (35.5 cm Olympic adaptor sleeve) Color: red
Dimensions:	L 162.5 x W 55.8 x H 116.8 cm - Ø 25 mm		
Warranty:	Frame: 10 years - Parts: 2 years		
BFAB20	Best Fitness Semi-Recumbent Ab Bench		€ 399.00



	POWERLINE AB BOARD		SPECIFICATIONS
	ITEM#: PAB139X	Weight: 15.9 kg	<ul style="list-style-type: none"> Isolates the entire abdominal region Oversize 20 cm Foam Rollers 56 cm long back pad
Dimensions:	L 100.5 x W 49.7 x H 60 cm		
Warranty:	Frame: 10 years - Parts: 2 years		
PAB139X	Powerline Ab Board		€ 179.00



	POWERLINE SEATED CABLE AB CRUNCH		SPECIFICATIONS
	ITEM#: PAB21X	Weight: 14 kg	<ul style="list-style-type: none"> Full range abdominal resistance Curved back pad puts you in a pre-stretch position Extra-wide, sealed ball bearing pulley Infinitely adjustable back pad Excellent for triceps extensions too
Dimensions:	L 101.6 x W 46.5 x H 96.5 cm		
Warranty:	Frame: 10 years - Parts: 2 years		
PAB21X	Powerline Ab Bench		€ 189.00



	ADJUSTABLE AB BOARD		SPECIFICATIONS
	ITEM#: GAB60	Weight: 18 kg	<ul style="list-style-type: none"> 5 x 5 cm steel mainframe Adjusts to 12 positions Thick DuraFirm™ padding Oversized foam rollers
Dimensions:	L 137.1 x W 61 x H 132 cm		
Warranty:	In-Home Lifetime / Light Commercial (P. 119)		
GAB60	Body-Solid Adjustable Ab Board		€ 289.00



	COUNTER BALANCE AB CRUNCH		SPECIFICATIONS
	ITEM#: GAB100	Weight: 32.8 kg	<ul style="list-style-type: none"> Works Upper and Lower Abdominals in One Movement Synchronized Weight Resistance and Assistance Weight Post
Dimensions:	L 154.6 x W 83 x H 101.2 cm		
Warranty:	In-Home Lifetime / Light Commercial (P. 119)		
GAB100	Body-Solid Horizontal Ab Crunch Bench		€ 459.00



AB & BACK



	SEMI-RECUMBENT AB BENCH		SPECIFICATIONS
	ITEM#: GAB300 Weight: 45.5 kg Dimensions: L 176.5 x W 84 x H 132 cm / Ø 50 mm Warranty: In-Home Lifetime / Light Commercial (P. 119)		<ul style="list-style-type: none"> • Isolates Upper and Lower ABS • Seat adjustment • Resistance and Assistance Weight Post
GAB300	Body-Solid Semi-Recumbent Ab Bench		€ 595.00



	CAM SERIES AB & BACK		SPECIFICATIONS
	ITEM#: GCAB360 Weight: 34 kg Dimensions: L 150 x W 112.3 x H 109.2 cm / Ø25 mm Warranty: In-Home Lifetime / Light Commercial (P. 119)		<ul style="list-style-type: none"> • Thick DuraFirm™ padding • 5 x 10 cm steel mainframe • Positioned at a 30° angle for precise biomechanical movement
GCAB360	Body-Solid Cam Series Ab / Back Machine		€ 625.00
OPTIONAL ATTACHMENTS			
OAS8	OPTIONAL 20 cm Olympic Adapter Sleeve		€ 12.00
OAS14	OPTIONAL 35 cm Olympic Adapter Sleeve		€ 20.00



	PRO CLUBLINE AB BENCH		SPECIFICATIONS
	ITEM#: SAB500 Weight: 57 kg Dimensions: L 175.1 x W 66.6 x H 124 cm Warranty: In-Home Lifetime / Full Commercial (P. 119)		<ul style="list-style-type: none"> • Gas assisted adjustment • 4 Point base eliminates rocking • Transport wheels and handle • Oval 11 gauge steel frame
SAB500	Pro Clubline Commercial Ab Bench		€ 895.00



	ABCRUNCH ABDOMINAL MACHINE		SPECIFICATIONS
	ITEM#: GAB400 Weight N/G: 54 kg / 58.5 kg Dimensions: Product: L 75 x W 85 x H 155 cm Carton 1: L 66 x W 35 x H 23 cm Carton 2: L 116 x W 78 x H 19 cm Warranty: Frame: lifetime - Parts: 2 years		<ul style="list-style-type: none"> • Requires absolute no preconditioning • Isolates front abs, left and right obliques • Puts no stress on the lower back • No maintenance needed • Adjustable seat for upper and lower abs • Seat can be positioned sideways to hit obliques • Maximum user weight: 125 kg • Plate loaded: 25 / 28 / 30 mm • EN957 / CE quality certification
GAB400	Abcrunch Abdominal Machine		€ 995.00



	ABCRUNCH ABDOMINAL MACHINE		SPECIFICATIONS
	ITEM#: SAB1300 Weight N/G: 76 kg / 80 kg Dimensions: Product: L 84 x W 105 x H 165 cm Carton 1: L 117 x W 93 x H 19 cm Carton 2: L 73 x W 68 x H 45 cm Warranty: Frame: lifetime - Parts: 2 years		<ul style="list-style-type: none"> • Resistance can be increased/decreased • Requires absolute no preconditioning • Isolates front abs, left and right oblique's • Seat pad can be locked/unlocked i • Seat can be positioned sideways • 2 Storage locations included • Maximum user weight: 145 kg • Plate loaded: Olympic 50 kg • EN957 - CE quality certification
SAB1300	Abcrunch Abdominal Machine		€ 1995.00



	BEST FITNESS INVERSION TABLE		SPECIFICATIONS
	ITEM#: BFINVER10 Weight: 21 kg Dimensions: L 119.4 x W 76.2 x H 152.4 cm Warranty: Frame: 10 years - Parts: 2 years		<ul style="list-style-type: none"> • Durable nylon back pad • Adjustable nylon angle strap • Foldable • Height adjustable • Color: red
BFINVER10	Best Fitness Inversion Table		€ 275.00



	INVERSION TABLE		SPECIFICATIONS	
	ITEM#: GINV50		<ul style="list-style-type: none"> • Reduce stress on your back, increase flexibility, promote muscle stimulation • Stable, extra heavy gauge steel frame • Thick durable padding • Proprietary ankle adjustment 	
Weight: 24 kg				
Dimensions: L 182 x W 71 x H 201 cm				
Warranty: In-Home Lifetime / Light Commercial (P. 119)				
GINV50	Body-Solid Inversion Table		€ 525.00€	



	BEST FITNESS FOLDABLE AB BOARD HYPEREXTENSION		SPECIFICATIONS	
	ITEM#: BFHYP10		<ul style="list-style-type: none"> • Fold up design • Oversized foam rollers for additional comfort • Fully adjustable for any size user • 45° Back Hyperextension • Ab Crunches 	
Weight: 13.3 kg				
Dimensions: L 125.7 x W 73.6 x H 81.2 cm (Foldable)				
Warranty: Frame: 10 years - Parts: 2 years				
BFHYP10	Best Fitness Ab Board Hyperextension Foldable Bench		€ 245.00	











	POWERLINE ROMAN CHAIR		SPECIFICATIONS	
	ITEM#: PCH24X		<ul style="list-style-type: none"> • 5 x 5 cm heavy-gauge steel construction • Extra-wide base eliminates rocking • Lets you train abs, back, glutes and hams in complete comfort and safety 	
Weight: 18.2 kg				
Dimensions: L 116.2 x W 61.5 x H 102 cm				
Warranty: Frame: 10 years - Parts: 2 years				
PCH24X	Powerline Roman Chair		€ 225.00	



	POWERLINE 45 DEGREE BACK HYPEREXTENSION		SPECIFICATIONS	
	ITEM#: PHYP200X		<ul style="list-style-type: none"> • Set at an exact 45° angle • Telescoping split midsection pads • Fully adjustable 10 cm thick midsection pads • Thick, double stitched pads for comfort and support 	
Weight: 19.7 kg				
Dimensions: L 105.5 x W 68.6 x H 77.5 cm				
Warranty: Frame: lifetime - Parts: 2 years				
PHYP200X	Powerline 45 Degree Back Hyperextension		€ 325.00	



	45 DEGREE BACK HYPEREXTENSION		SPECIFICATIONS	
	ITEM#: GHYP345		<ul style="list-style-type: none"> • 5 x 7.6 cm Construction • Ideal for home or commercial use • Fully adjustable 10 cm thick midsection pads • Comfortable split pad design 	
Weight: 31 kg				
Dimensions: L 127 x W 66 x H 91.4 cm				
Warranty: In-Home Lifetime / Light Commercial (P. 119)				
GHYP345	Body-Solid 45 Degree Back Hyperextension		€ 349.00	



	ROMAN CHAIR		SPECIFICATIONS	
	ITEM#: GRCH322		<ul style="list-style-type: none"> • 5 x 7.6 cm heavy-gauge steel construction • Thick DuraFirm™ split support pads • Oversize foam rollers are pop-pin adjustable • Extra-wide base eliminates rocking • Rollers adjust both vertically and horizontally to fit all size users 	
Weight: 31.8 kg				
Dimensions: L 114.3 x W 66 x H 109.2 cm				
Warranty: In-Home Lifetime / Light Commercial (P. 119)				
GRCH322	Body-Solid Roman Chair		€ 395.00	



	PRO CLUBLINE GLUTE HAM MACHINE		SPECIFICATIONS	
	ITEM#: SGH500		<ul style="list-style-type: none"> • Vertical and horizontal adjustments ensure proper fit for any size user • Isolates lower posterior muscles • Works glutes, hamstrings, calves, abs and obliques in one machine • Step for easy access / Oversized pads 	
Weight: 62 kg				
Dimensions: L 195.8 x W 82.8 x H 125.9 cm				
Warranty: Full Commercial (P. 119)				
SGH500	Pro Clubline Glute Ham Developer		€ 995.00	



 	<p>BEST FITNESS VERTICAL KNEE RAISE</p> <p>ITEM#: BFVK10</p> <p>Weight: 31.4 kg</p> <p>Dimensions: L 190.2 x W 71.1 x H 210.8 cm</p> <p>Warranty: Frame: 10 years - Parts: 2 years</p>	<p>SPECIFICATIONS</p> <ul style="list-style-type: none"> • Verticle knee raise • Chin up station • Dip station • Dip handle width 56 cm
<p>BFVK10</p>	<p>Best Fitness Vertical Knee Raise Chin Dip Machine</p>	<p>€ 299.00</p>
 	<p>POWERLINE VERTICAL KNEE RAISE CHIN DIP</p> <p>ITEM#: PVKC83X</p> <p>Weight: 29.3 kg</p> <p>Dimensions: L 88 x W 106.8 x H 210.8 cm</p> <p>Warranty: Frame: 10 years - Parts: 2 years</p>	<p>SPECIFICATIONS</p> <ul style="list-style-type: none"> • Safe No-Slip step up entry • Thick DuraFirm™ back and arm pads • Comfortable oversized handgrips • Push-up Station is cushioned • Push-up Station is mounted a full 12" off the floor • Dip handle width 56 cm
<p>PVKC83X</p>	<p>Powerline Vertical Knee Raise Chin Dip Machine</p>	<p>€ 369.00</p>
	<p>VERTICAL KNEE RAISE & DIP STATION</p> <p>ITEM#: GVKR60</p> <p>Weight: 27.7 kg</p> <p>Dimensions: L 94 x W 61 x H 152.4 cm</p> <p>Warranty: In-Home Lifetime / Light Commercial (P. 119)</p> 	<p>SPECIFICATIONS</p> <ul style="list-style-type: none"> • Safe, no-slip step-up entry • Thick DuraFirm™ back and arm pads • Comfortable oversized handgrips • 5 x 5 cm steel mainframe • Dip handle width 56 cm
<p>GVKR60</p>	<p>Body-Solid Vertical Knee Raise and Dip Station</p>	<p>€ 459.00</p>
	<p>VERTICAL KNEE RAISE CHIN DIP</p> <p>ITEM#: GVKR82</p> <p>Weight: 51 kg</p> <p>Dimensions: L 146.5 x W 107 x H 208.2 cm</p> <p>Warranty: In-Home Lifetime / Light Commercial (P. 119)</p> 	<p>SPECIFICATIONS</p> <ul style="list-style-type: none"> • 5 x 5 cm steel mainframe • Thick DuraFirm™ back pad for extra lumbar support • Dip Station features oversized diameter grips • 10° reverse pitch increases abdominal range-of-motion • Dip handle width 56 cm
<p>GVKR82</p>	<p>Body-Solid Vertical Knee Raise Chin Dip</p>	<p>€ 545.00</p>
	<p>FUSION KNEE RAISE CHIN DIP</p> <p>ITEM#: FCD</p> <p>Weight: 62 kg</p> <p>Dimensions: L 159 x W 107.1 x H 210.8 cm</p> <p>Warranty: In-Home Lifetime / Light Commercial (P. 119)</p> 	<p>SPECIFICATIONS</p> <ul style="list-style-type: none"> • 5 x 7.6 cm Oval Mainframe Construction • Multipositioning on Lat / Chin-Up station • Thick DuraFirm™ upholstery • Oversized back pad • Dip handle width 56 cm
<p>FCD</p>	<p>Fusion Premium Knee Raise Chin Dip</p>	<p>€ 650.00</p>
	<p>PRO CLUBLINE VERTICAL KNEE RAISE</p> <p>ITEM#: SVKR1000</p> <p>Weight: 169 kg</p> <p>Dimensions: L 93.5 x W 157.5 x H 262 cm</p> <p>Warranty: Full Commercial (P. 119)</p> 	<p>SPECIFICATIONS</p> <ul style="list-style-type: none"> • Multiple Close and Wide Grips • Rock Climbing Grips • Revolving Dip Handles (move out of the way for other exercises) • Multiple Steps for Easy Access • Oval Heavy Gauge Steel Frame
<p>SVKR1000</p>	<p>Pro Clubline Vertical Knee Raise Chin Dip</p>	<p>€ 2295.00</p>

	COMMERCIAL WEIGHT SLED		SPECIFICATIONS
	ITEM#: GWS100		<ul style="list-style-type: none"> • Removable Posts • Heavy Gauge Steel Frame • Center weight horn • Multiple handles to push and pull • Attachment Anchors
Weight: 30.8 kg			
Dimensions: L 106.2 x W 77.6 x H 101 cm / Ø 50 mm			
Warranty: Full Commercial (P. 119)			
GWS100	Body-Solid Weight Sled		€ 379.00



	SISSY SQUAT		SPECIFICATIONS
	ITEM#: GSS50		<ul style="list-style-type: none"> • Easy transport wheels and handles • Non-slip treaded footplate • Adjustable leg pad • Resistance band attachment points • Lowest adjustment: 28 x 38 cm • Highest adjustment: 38 x 48 cm • 130 kg capacity.
Weight: 21 kg			
Dimensions: L 110.5 x W 61 x H 48 cm			
Warranty: In-Home Lifetime / Light Commercial (P. 119)			
GSS50	Body-Solid Sissy Squat		€ 349.00



	POWERLINE LEG EXTENSION / CURL MACHINE		SPECIFICATIONS
	ITEM#: PLCE165X		<ul style="list-style-type: none"> • Perform both Leg Extensions & Leg Curls • Traditional upright Leg Extensions • Traditional prone Leg Curls
Weight: 20 kg			
Dimensions: L 157.5 x W 63 x H 68.6 cm - Ø 25 mm			
Warranty: Frame: 10 years - Parts: 2 years			
PLCE165X	Powerline Leg Extension / Curl Machine	Weights & clips not included	€ 425.00
OPTIONAL ATTACHMENTS			
OAS8	OPTIONAL 20 cm Olympic Adapter Sleeve		€ 12.00
OAS14	OPTIONAL 35 cm Olympic Adapter Sleeve		€ 20.00



	POWERLINE VERTICAL LEG PRESS MACHINE		SPECIFICATIONS
	ITEM#: PVLP156X		<ul style="list-style-type: none"> • Three Ø 2.5 cm weight posts • Nylon bushings for smooth, consistent motion • Extra-wide foot plate with no-slip design • Thick back and neck pads • Dual adjustable steel locking pins • 3 different starting and stopping positions
Weight: 35 kg			
Dimensions: L 114.8 x W 120.5 x H 139.5 - 152 cm / Ø 25 mm			
Warranty: Frame: 10 years - Parts: 2 years			
PVLP156X	Powerline Vertical Leg Press Machine		€ 489.00
OPTIONAL ATTACHMENTS			
OAS8	OPTIONAL 20 cm Olympic Adapter Sleeve		€ 12.00
OAS14	OPTIONAL 35 cm Olympic Adapter Sleeve		€ 20.00



	CAM SERIES TOTAL HIP		SPECIFICATIONS
	ITEM#: GCMH390		<ul style="list-style-type: none"> • Adjustable angle • 12 adjustable positions. • Reinforced structure of 5 x 5 cm, • Thigh protector: long roll of very compact foam, • Easy installation of weights discs
Weight: 28.5 kg			
Dimensions: L 100 x W 99 x H 117 cm			
Warranty: In-Home Lifetime / Light Commercial (P. 119)			
GCMH390	Body-Solid Cam series Total Hip		€ 625.00



	POWERLINE GLUTE MAX ITEM#: PGM200X Weight: 30.4 kg Dimensions: L 166.5 x W 66.5 x H 152.5 cm - Ø 25 mm Warranty: Frame: 10 years - Parts: 2 years	SPECIFICATIONS <ul style="list-style-type: none"> Total glute isolation for maximum results Sealed bearing rollers for smooth action Comfortable padding Stabilizer handles to ensure proper form
	PGM200X Powerline Glute Max € 625.00	OPTIONAL ATTACHMENTS OAS8 OPTIONAL 20 cm Olympic Adapter Sleeve € 12.00 OAS14 OPTIONAL 35 cm Olympic Adapter Sleeve € 20.00



	CAM SERIES LEG EXT / CURL MACHINE ITEM#: GCEC340 Weight: 32.5 kg Dimensions: L 124.5 x W 106.7 x H 94 cm - Ø 25 mm Warranty: In-Home Lifetime / Light Commercial (P. 119)	 <ul style="list-style-type: none"> Thick DuraFirm™ padding 5 x 5 and 5 x 10 cm steel mainframe Oversized 20 cm foam rollers
	GCEC340 Body-Solid Cam Series Leg Ext / Curl Machine Weights & clips not included € 625.00	OPTIONAL ATTACHMENTS OAS8 OPTIONAL 20 cm Olympic Adapter Sleeve € 12.00 OAS14 OPTIONAL 35 cm Olympic Adapter Sleeve € 20.00



	5 X 8 CM LEG CURL / EXTENSION STATION ITEM#: GLCE365 Weight: 41.8 kg Dimensions: L 188 x W 68.5 x H 78.8 cm - Ø 25 mm Warranty: In-Home Lifetime / Light Commercial (P. 119)	 <ul style="list-style-type: none"> Commercial 5 x 7.6 cm heavy-gauge steel frame DuraFirm™ pads are extra-thick Back pad can be set to 3 upright positions and 2 supinated positions for traditional leg curls Oversize 20 cm foam rollers
	GLCE365 Body-Solid 5 X 7.6 cm Adj. Leg Curl / Extension Station € 625.00	OPTIONAL ATTACHMENTS OAS8 OPTIONAL 20 cm Olympic Adapter Sleeve € 12.00 OAS14 OPTIONAL 35 cm Olympic Adapter Sleeve € 20.00



	LEVERAGE SQUAT CALF MACHINE ITEM#: GSCL360 Weight: 77.4 kg Dimensions: L 157.5 x W 109.2 x H 142.2 cm Warranty: In-Home Lifetime / Light Commercial (P. 119)	 <ul style="list-style-type: none"> Heavy-gauge foot platform is set to a 20° pitch 7.6 x 7.6 cm 12-gauge steel mainframe Thick contoured DuraFirm™ shoulder and back pads Spring-loaded lockouts handle Innovative calf raise block is round
	GSCL360 Body-Solid Leverage Squat Calf Machine € 945.00	



	COMPACT LEG PRESS ITEM#: GCLP100 Weight: 104 kg Dimensions: L 170 x W 119.4 x H 116.4 cm Warranty: In-Home Lifetime / Light Commercial	 <ul style="list-style-type: none"> Combines leg press & calf raise in one machine For Olympic weight plates only Carriage with sealed linear bearings Heavy-gauge steel construction Adjustable to fit any size user Commercial-rated
	GCLP100 Body-Solid Compact Leg Press € 1195.00	OPTIONAL ATTACHMENTS GCLP-STD Bodysolid Adapter 25 mm for GCLP100 Compact Leg Press € 69.00



	COMPACT LEG PRESS ITEM#: GCLP100-25S Weight: 104 kg Dimensions: L 170 x W 119.4 x H 116.4 cm Warranty: In-Home Lifetime / Light Commercial	 <ul style="list-style-type: none"> Combines leg press & calf raise in one machine For standard weight plates only Carriage with sealed linear bearings Heavy-gauge steel construction Adjustable to fit any size user Commercial-rated
	GCLP100-25S Body-Solid Compact Leg Press € 1249.00	

LEG PRESS HACK SQUAT MACHINE		SPECIFICATIONS
	ITEM#: GLPH1100 Weight: 144.2 kg Dimensions: L 210.8 x W 86.3 x H 142.2 cm / Ø 50 mm Warranty: In-Home Lifetime / Light Commercial (P. 119)	 <ul style="list-style-type: none"> • Both back pads utilize a quick flip-and-lock mechanism • 2 heavy gauge Diamond Plate foot platforms • Heavy-duty 11-gauge steel mainframe • 10 cm thick DuraFirm™ padding • Three lockout positions for user safety
	GLPH1100 Body-Solid Leg Press Hack Squat Machine Ø 50 mm € 1795.00	
GLPH1100-25S Body-Solid Leg Press Hack Squat Machine Ø 25 mm € 1850.00		



ADAPTER FOR GLPH1100 FROM 50 TO 25 MM		SPECIFICATIONS
	ITEM#: GLPH1100S Weight: 10 kg Dimensions: N/A Warranty: In-Home Lifetime / Light Commercial (P. 119)	
	GLPH1100-S Adapter for GLPH1000 from 50 mm to 25 mm € 55.00	



PRO CLUBLINE PROFESSIONAL LEGPRESS (45°)		SPECIFICATIONS
	ITEM#: GLPH2100 Weight: 182 kg Dimensions: L 211 x W 86 x H 142 cm - Ø 50 mm Warranty: Full Commercial (P. 119)	 <ul style="list-style-type: none"> • Quick flip-and-lock mechanism • Extra-heavy gauge diamond plate foot platforms • Easy-access under-carriage plate load system • Heavy-duty 5 x 10 cm 11-gauge steel mainframe • Ultra-tough 10 cm DuraFirm™ back & shoulder pads • Three lockout positions for safety and convenience
	GLPH2100 Pro Clubline Professional Leg Press (45°) € 3295.00	



PRO CLUBLINE LEVERAGE SQUAT		SPECIFICATIONS
	ITEM#: SLS500 Weight: 180.5 kg Dimensions: L 189 x W 155.7 x H 170.8 cm / Ø 50 mm Warranty: Full Commercial (P. 119)	 <ul style="list-style-type: none"> • Biomechanically Correct Angled Squat Platform • Rounded Calf Block Provides Extra Range of Motion • Oval 11 Gauge Steel Frame • Plate Storage Horns
	SLS500 Pro Clubline Leverage Squat Machine € 2495.00	



CALF SQUAT BLOCK		SPECIFICATIONS
	ITEM#: SCB26 Weight: 12.6 kg Dimensions: L 66 x W 21.5 x H 16.5 cm Warranty: In-Home Lifetime / Light Commercial (P. 119)	 <ul style="list-style-type: none"> • Combination squat platform and calf block • Solid steel, 2 bolt assembly, includes welded carrying handle and textured • No-slip surfaces • 900 kg capacity.
	SCB26 Body-Solid Calf Squat Block € 149.00	



POWERLINE SEATED CALF MACHINE		SPECIFICATIONS
	ITEM#: PSC43X Weight: 19.8 kg Dimensions: L 118.8 x W 53 x H 81.3 cm - Ø 25 mm Warranty: Frame: 10 years - Parts: 2 years	<ul style="list-style-type: none"> • 3:1 weight ratio • Angled foot platform with no-slip surface • Adjustable for all size users
	PSC43X Powerline Seated Calf Machine € 259.00	
OPTIONAL ATTACHMENTS		
OAS8	OPTIONAL 20 cm Olympic Adapter Sleeve	€ 12.00
OAS14	OPTIONAL 35 cm Olympic Adapter Sleeve	€ 20.00



SEATED CALF RAISE MACHINE		SPECIFICATIONS
	ITEM#: GSCR349	 <ul style="list-style-type: none"> • 5 x 7.6 cm 11-gauge steel mainframe • 7.6 cm thick DuraFirm™ padding • 3:1 weight ratio • Pillow block bearings at main pivot points • Angled foot platform with no-slip surface
	Weight: 42.4 kg	
	Dimensions: L 119.4 x W 58.4 x H 99 cm - Ø 25 mm	
	Warranty: In-Home Lifetime / Light Commercial (P. 119)	
GSCR349	Body-Solid 5 x 7.6 cm Seated Calf Raise Machine	Weights & clips not included: € 625.00
OPTIONAL ATTACHMENTS		
OAS8	OPTIONAL 20 cm Olympic Adapter Sleeve	€ 12.00
OAS14	OPTIONAL 35 cm Olympic Adapter Sleeve	€ 20.00



BEST FITNESS FUNCTIONAL TRAINER		SPECIFICATIONS
 	ITEM#: BFFT10	<ul style="list-style-type: none"> • Smaller Functional Trainer Footprint • 19 vertical pulley adjustments • Single 85 kg weight stack • Integrated Straight Chinning Bar • Color: Red
	Weight: 140.5 kg	
	Dimensions: L 139.7 x W 155 x H 212 cm	
	Warranty: Frame: 10 years - Parts: 2 years	
BFFT10	Best Fitness Functional Trainer	€ 1095.00



BEST FITNESS MOUNTAIN CLIMBER		SPECIFICATIONS
 	ITEM#: BFMC10	<ul style="list-style-type: none"> • Total body cardio workout • Strengthen and tone muscles • Target large muscle groups • Lower body stepper and upper body climber in one machine • Easy to store • Max. weight capacity: 150 kg
	N/G weight: 22 kg / 24 kg	
	Dimensions: Product: L 94 x W 50 x H 217 cm Carton: L 169.5 x W 22 x H 15.5 cm	
	Warranty: Frame: 10 years - Parts: 2 years	
BFMC10	Best Fitness Mountain Climber	€ 395.00



BEST FITNESS SPORTSMAN GYM		SPECIFICATIONS
 	ITEM#: BFMG20	<ul style="list-style-type: none"> • 68 kg weight stack • Chest Press • Pec Fly • High and Low Pulley • Leg Extension and Leg Curl
	Weight: 119 kg	
	Dimensions: L 162.5 x W 119.4 x H 198 cm	
	Warranty: Frame: 10 years - Parts: 2 years	
BFMG20	Best Fitness Sportsmans Gym	€ 749.00



BEST FITNESS HOME GYM		SPECIFICATIONS
 	ITEM#: BFMG30	<ul style="list-style-type: none"> • Multi-functional, fully-adjustable single-stack gym • No cable-change design • Welded steel mainframe • Sealed bearings • Five unique workout stations for a full-body workout • 65 kg weight stack
	Weight: 153 kg	
	Dimensions: L 182 x W 1198.3 x H 210.8 cm	
	Warranty: Frame: 10 years - Parts: 2 years	
BFMG30	Best Fitness Home Gym	€ 1295.00



BEST FITNESS CABLE CROSSOVER		SPECIFICATIONS
 	ITEM#: BFCCO10	<ul style="list-style-type: none"> • Designed for use in home and garage gyms • No cable change design • 180-degree swiveling pulleys • Nylon bushings & chrome guide rods
	Weight: 46.3 kg	
	Dimensions: L 94 x W 279.5 x H 210.8 cm	
	Warranty: Frame: 10 years - Parts: 2 years	
BFCCO10	Body-Solid Cable Crossover	€ 599.00



 	BEST FITNESS WEIGHT TREE		SPECIFICATIONS
	ITEM#: BFWT10 Weight: 18.2 kg Dimensions: L 61 x W 63.5 x H 134.6 cm Warranty: Frame: 10 years - Parts: 2 years		<ul style="list-style-type: none"> • Six 23 cm weight horns for storage of bumper and Olympic plates • Two Olympic bar holders • Weight capacity: 180 kg
BFWT10	Best Fitness Weight Tree		€ 159.00



 	BEST FITNESS DUMBBELL RACK		SPECIFICATIONS
	ITEM#: BFDR10 Weight: 21 kg Dimensions: L 106.7 x W 58.4 x H 76.2 cm Warranty: Frame: 10 years - Parts: 2 years		<ul style="list-style-type: none"> • Keep workout areas clean, organized and safe • Three-tier dumbbell rack • Holds 10 pairs of hex dumbbells (2-22 kg) • Powder-coat finish
BFDR10	Body-Solid Dumbbell Rack		€ 169.00

 	BEST FITNESS INVERSION TABLE		SPECIFICATIONS
	ITEM#: BFINVER10 Weight: 21 kg Dimensions: L 119.4 x W 76.2 x H 152.4 cm Warranty: Frame: 10 years - Parts: 2 years		<ul style="list-style-type: none"> • Durable nylon back pad • Adjustable nylon angle strap • Foldable • Height adjustable • Color: red
BFINVER10	Best Fitness Inversion Table		€ 275.00

 	BEST FITNESS VERTICAL KNEE RAISE		SPECIFICATIONS
	ITEM#: BFVK10 Weight: 31.4 kg Dimensions: L 190.2 x W 71.1 x H 210.8 cm Warranty: Frame: 10 years - Parts: 2 years		<ul style="list-style-type: none"> • Vertical knee raise • Chin up station • Dip station • Dip handle width 56 cm
BFVK10	Best Fitness Vertical Knee Raise Chin Dip Machine		€ 299.00

 	BEST FITNESS FOLDABLE AB BOARD HYPEREXTENSION		SPECIFICATIONS
	ITEM#: BFHYP10 Weight: 13.3 kg Dimensions: L 125.7 x W 73.6 x H 81.2 cm (Foldable) Warranty: Frame: 10 years - Parts: 2 years		<ul style="list-style-type: none"> • Fold up design • Oversized foam rollers for additional comfort • Fully adjustable for any size user • 45° Back Hyperextension • Ab Crunches
BFHYP10	Best Fitness Ab Board Hyperextension Foldable Bench		€ 245.00

 	BEST FITNESS MULTI-PRESS STAND		PACKAGE INCLUDES
	ITEM#: BFPR10 Weight: 30.5 kg Dimensions: L 75 x W 114.3 x H 143.5 cm Warranty: Frame: 10 years - Parts: 2 years		<ul style="list-style-type: none"> • 5 x 5 cm mainframe design • Adjustable space saving design • For doing Flat, Incline and Decline Bench Presses, Squats, Curls, Upright Rows, Shrugs, Calf Raises and much more • Color: Red
BFPR10	Best Fitness Olympic Multi-Press Stand		Weights & clips not included € 295.00

 	BEST FITNESS LEG PREACHER CURL FOR BFFID10		SPECIFICATIONS
	ITEM#: BFPL10 Weight: 12.3 kg Dimensions: L 182.8 x W 50.8 x H 101.6 cm Warranty: Frame: 10 years - Parts: 2 years		<ul style="list-style-type: none"> • 10 cm high density foam roller pads for leg extension and prone leg curl • Removable preacher curl pad with 4.5 cm durable upholstery • Adjustable arm curl handle • Safety pins and bolts for easy adjustments
BFPL10	Beste Fitness Leg Preacher Curl for BFFID10		€ 215.00

Home Use Only	BEST FITNESS FOLDING AB	SPECIFICATIONS
	ITEM#: BFAB10 Weight: 11 kg Dimensions: L 106.7 x W 45.7 x H 58.4 cm Warranty: Frame: 10 years - Parts: 2 years	<ul style="list-style-type: none"> Adjustable and foldable Effective in isolating the entire abdominal region Comfortable foam rollers keep you locked into position Long back pad accommodates even the tallest user Color: red
	BFAB10 Best Fitness Folding Ab Board	€ 199.00



Home Use Only	BEST FITNESS SEMI RECUMBENT AB BENCH	SPECIFICATIONS
	ITEM#: BFAB20 Weight: 27.5 kg Dimensions: L 162.5 x W 55.8 x H 116.8 cm - Ø 25 mm Warranty: Frame: 10 years - Parts: 2 years	<ul style="list-style-type: none"> Heavy gauge steel mainframe Seat adjustment Isolates upper and lower abs Resistance and assistance weight post Optional OA8 (20 cm Olympic adaptor sleeve) & oas14 (35.5 cm Olympic adaptor sleeve) Color: red
	BFAB20 Best Fitness Semi-Recumbent Ab Bench	€ 399.00



Home Use Only	BEST FITNESS FID FOLDING BENCH	SPECIFICATIONS
	ITEM#: BFFID10 Weight: 16 kg Dimensions: L 162.5 x W 56 x H 116.8 cm Warranty: Frame: 10 years - Parts: 2 years	<ul style="list-style-type: none"> 4 position from 0 to 90 ° Fold up design Fully assembled in box Perfect for dumbbell exercises Color: Red
	BFFID10 Best Fitness FID Folding Bench	€ 245 .00



Home Use Only	BEST FITNESS FOLDING BENCH	SPECIFICATIONS
	ITEM#: BFFID25 Weight: 15.4 kg Dimensions: L 144.8 x W 38 x H 45.7 cm Warranty: Frame: 10 years - Parts: 2 years	<ul style="list-style-type: none"> Fully assembled out of the box Ladder-style back pad adjustments Folds for easy storage (22 cm H) Weight Capacity: 200 kg
	BFFID25 Best Fitness Folding Bench	€ 199.00



Home Use Only	BEST FITNESS OLYMPIC FOLDING BENCH	SPECIFICATIONS
	ITEM#: BFOB10 Weight: 32.21 kg Dimensions: L 172.7 x W 104 x H 147.3 cm Warranty: Frame: 10 years - Parts: 2 years	<ul style="list-style-type: none"> Adjustable from Flat to Incline Adjustable Uprights Adjustable space saving design Fold Up Storage position Color: red
	BFOB10 Best Fitness Olympic Bench	€ 389.00
OPTIONAL ATTACHMENTS		
OAS8	OPTIONAL 20 cm Olympic Adapter Sleeve	€ 12.00
OAS14	OPTIONAL 35 cm Olympic Adapter Sleeve	€ 20.00



Home Use Only	BEST FITNESS POWER RACK	SPECIFICATIONS
	ITEM#: BFPR100 Weight: 48.7 kg Dimensions: L 15 x W 119.6 x H 209 cm Warranty: Frame: 10 years - Parts: 2 years	<ul style="list-style-type: none"> 18 Start / Stop Positions Wide Walk-in Design Includes 2 heat-tempered Lift Offs and 2 Saber style Safety Rods
	BFPR100 Best Fitness Lat Attachment for PPR200X	€ 575.00
OPTIONAL ATTACHMENTS		
DR100	Dip Attachment for PPR200 & BRPR100	€ 119.00
SCB26	Squat / Calf Block	€ 149.00



PRO CLUBLINE CHEST PRESS		SPECIFICATIONS
	ITEM#: SBP100G Weight: 205 kg Dimensions: L 114.3 x W 134.6 x H 157.4 cm Warranty: Full Commercial (P. 119)	 <ul style="list-style-type: none"> • Nylon-coated, self-lubricating, aircraft-quality steel cables • Fiberglass reinforced nylon pulleys • Extra-tough, tear-resistant DuraFirm™ upholstery • Highly-polished, chrome plated solid steel guide rods
	SBP100G-2 Pro Clubline Chest Press 95 kg Weight Stack € 2895.00	
SBP100G-3 Pro Clubline Chest Press 140 kg Weight Stack € 3045.00		



PRO CLUBLINE LEG EXTENSION		SPECIFICATIONS
	ITEM#: SLE200G Weight: 202.5 kg Dimensions: L 106.6 x W 99 x H 182.8 cm Warranty: Full Commercial (P. 119)	 <ul style="list-style-type: none"> • 5 x 10 cm Steel Mainframe • Extra-tough, tear-resistant DuraFirm™ • Biomechanically accurate pivot point ensures correct body positioning
	SLE200G-2 Pro Clubline Leg Extension 95 kg Weight Stack € 2895.00	
SLE200G-3 Pro Clubline Leg Extension 140 kg Weight Stack € 3045.00		



PRO CLUBLINE LAT MID ROW		SPECIFICATIONS
	ITEM#: SLM300G Weight: 206 kg Dimensions: L 162.5 x W 117 x H 210.8 cm Warranty: Full Commercial (P. 119)	 <ul style="list-style-type: none"> • 5 x 10 cm Steel Mainframe • Extra-tough, tear-resistant DuraFirm™ • High pulley is directly overhead for optimum back and shoulder isolation
	SLM300G-2 Pro Clubline Lat Mid Row 95 kg Weight Stack € 3095.00	
SLM300G-3 Pro Clubline Lat Mid Row 140 kg Weight Stack € 3245.00		



PRO CLUBLINE LEG CURL		SPECIFICATIONS
	ITEM#: SLC400G Weight: 203.2 kg Dimensions: L 167.6 x W 99 x H 157.5 cm Warranty: Full Commercial (P. 119)	 <ul style="list-style-type: none"> • 5 x 10 cm Steel Mainframe • Extra-tough, tear-resistant DuraFirm™ • Biomechanically accurate pivot point ensures correct body positioning
	SLC400G-2 Pro Clubline Leg Curl 95 kg Weight Stack € 2795.00	
SLC400G-3 Pro Clubline Leg Curl 140 kg Weight Stack € 2945.00		



PRO CLUBLINE LEG PRESS		SPECIFICATIONS
	ITEM#: SLP500G Weight: 252 kg Dimensions: L 203.2 x W 101.6 x H 182.8 cm Warranty: Full Commercial (P. 119)	 <ul style="list-style-type: none"> • 5 x 10 cm Steel Mainframe • Extra-tough, tear-resistant DuraFirm™ • Pillow block and sealed ball-bearings
	SLP500G-2 Pro Clubline Leg Press 95 kg Weight Stack € 3395.00	
SLP500G-3 Pro Clubline Leg Press 140 kg Weight Stack € 3545.00		



PRO CLUBLINE BICEPS CURL MACHINE		SPECIFICATIONS
	ITEM#: SBC600 Weight: 185 kg Dimensions: L 115 x W 135 x H 158 cm Warranty: Full Commercial (P. 119)	 <ul style="list-style-type: none"> • Multi-grip, revolving handles bar • Fully adjustable seat / Variable resistance cam • Shrouded weight stack 95 kg • Fiberglass reinforced nylon pulleys • 5 x 10 cm high-tensile strength steel • Chrome plated solid steel guide rods
	SBC600-2 Pro Clubline Biceps Curl 95 kg Weight Stack € 2895.00	
SBC600-3 Pro Clubline Biceps Curl 140 kg Weight Stack € 3045.00		



PRO CLUBLINE PEC DEC MACHINE		SPECIFICATIONS
	ITEM#: SPD700 Weight: 212 kg Dimensions: L 166 x W 82 x H 158 cm Warranty: Full Commercial (P. 119)	 <ul style="list-style-type: none"> • Designed for bilateral or unilateral use • Hidden elliptical cams for variable resistance • Low center of gravity • Selectorized weight stack 95 kg • Nylon-coated, aircraft-quality steel cables • 5 x 10 cm high-tensile strength steel
	SPD700-2 Pro Clubline Pec Dec Machine 95 kg Weight Stack € 3395.00	
SPD700-3 Pro Clubline Pec Dec Machine 140 kg Weight Stack € 3545.00		

PRO CLUBLINE SHOULDER PRESS MACHINE		SPECIFICATIONS
	ITEM#: SSP800 Weight: 220 kg Dimensions: L 130 x W 163 x H 158 cm Warranty: Full Commercial (P. 119)	 <ul style="list-style-type: none"> • Low center of gravity • Pivot point is aligned at a level equal to the mid-point of exercise movement • High adjustable seat / Multi-position handgrips • Selectorized weight stack 95 kg • 5 x 10 cm high-tensile strength steel
	SSP800-2 Pro Clubline Shoulder Press 95 kg Weight Stack € 3095.00	
SSP800-3 Pro Clubline Shoulder Press 140 kg Weight Stack € 3245.00		

PRO CLUBLINE AB MACHINE		SPECIFICATIONS
	ITEM#: SAM900 Weight: 203 kg Dimensions: L 107 x W 117 x H 158 cm Warranty: Full Commercial (P. 119)	 <ul style="list-style-type: none"> • Comfortably contoured chest pad • Low centre of gravity for stability • Fully adjustable seat & leg hold-down rollers • Anti-slip footrest • Shrouded weight stack 95 kg • 5 x 10 cm high-tensile strength steel
	SAM900-2 Pro Clubline Ab Machine 95 kg Weight Stack € 3095.00	
SAM900-3 Pro Clubline Ab Machine 140 kg Weight Stack € 3245.00		

PRO CLUBLINE TRICEPS DOWN MACHINE		SPECIFICATIONS
	ITEM#: STM1000 Weight: 201 kg Dimensions: L 102 x W 107 x H 158 cm Warranty: Full Commercial (P. 119)	 <ul style="list-style-type: none"> • Fully adjustable seat (90°) • Nylon-coated, aircraft-quality steel cables • Selectorized weight stack 95 kg • Fiberglass reinforced nylon pulleys with v-grooved channels • 5 x 10 cm high-tensile strength steel
	STM1000-2 Pro Clubline Triceps Press Down 95 kg Weight Stack € 3095.00	
STM1000-3 Pro Clubline Triceps Press Down 140 kg Weight Stack € 3245.00		

PRO CLUBLINE INCLINE PRESS MACHINE		SPECIFICATIONS
	ITEM#: SIP1400 Weight: 243 kg Dimensions: L 127 x W 109 x H 158 cm Warranty: Full Commercial (P. 119)	 <ul style="list-style-type: none"> • Fully adjustable seat / Angled pressdown bars • Selectorized weight stack 95 kg • Fiberglass reinforced nylon pulleys with v-grooved channels • Nylon-coated, aircraft-quality steel cables • 5 x 10 cm high-tensile strength steel
	SIP1400-2 Pro Clubline Incline Press machine 95 kg Weight Stack € 3095.00	
SIP1400-3 Pro Clubline Incline Press machine 140 kg Weight Stack € 3245.00		

PRO CLUBLINE MULTI HIP MACHINE		SPECIFICATIONS
	ITEM#: SMH1500 Weight: 194 kg Dimensions: L 135 x W 115 x H 158 cm Warranty: Full Commercial (P. 119)	 <ul style="list-style-type: none"> • Unique adjustable range-of-motion cam • Extra no-slip platteform / Easy access • Handgrip on each side • Selectorized weight stack 95 kg • 5 x 10 cm high-tensile strength steel
	SMH1500-2 Pro Clubline Multi Hip 95 kg Weight Stack € 3195.00	
SMH1500-3 Pro Clubline Multi Hip 140 kg Weight Stack € 3345.00		

PRO CLUBLINE BACK MACHINE		SPECIFICATIONS
	ITEM#: SBK1600	<ul style="list-style-type: none"> • Low center of gravity for max. workout stability • Comfortably contoured back pad • Fully adjustable seat • Oversized Leg hold-down rollers • Weight stack 95 kg • 5 x 10 cm high-tensile strength steel
	Weight: 193 kg Dimensions: L 107 x W117 x H 158 cm Warranty: Full Commercial (P. 119)	
SBK1600-2	Pro Clubline Back Machine 95 kg Weight Stack	€ 3095.00
SBK1600-3	Pro Clubline Back Machine 140 kg Weight Stack	€ 3245.00







PRO CLUBLINE SEATED ROWING MACHINE		SPECIFICATIONS
	ITEM#: SRM1700	<ul style="list-style-type: none"> • Fully adjustable seat / Angled pressdown bars • Selectorized weight stack 95 kg • Fiberglass reinforced nylon pulleys with v-grooved channels • Nylon-coated, aircraft-quality steel cables • 5 x 10 cm high-tensile strength steel
	Weight: 201 kg Dimensions: L 115 x W 140 x H 158 cm Warranty: Full Commercial (P. 119)	
SRM1700-2	Pro Clubline Seated Rowing machine 95 kg Weight Stack	€ 3095.00
SRM1700-3	Pro Clubline Seated Rowing machine 140 kg Weight Stack	€ 3345.00



PRO CLUBLINE ROTARY TORSO MACHINE		SPECIFICATIONS
	ITEM#: SOT1800	<ul style="list-style-type: none"> • Multi-angle heavy-gauge steel diamond plate foot platform • Selectorized weight stack 95 kg • Fiberglass reinforced nylon pulleys • Nylon-coated, aircraft-quality steel cables • 5 x 10 cm high-tensile strength steel
	Weight: 252 kg Dimensions: L 157 x W 130 x H 123 cm Warranty: Full Commercial (P. 119)	
SOT1800-2	Pro Clubline Rotary Torso Machine 95 kg Weight Stack	€ 3395.00
SOT1800-3	Pro Clubline Rotary Torso Machine 140 kg Weight Stack	€ 3545.00



PRO CLUBLINE INNER OR OUTER THIGH		SPECIFICATIONS
	ITEM#: STH1100G	<ul style="list-style-type: none"> Adjustable Start position Long and comfortable angled seat 2 anti-slip handles on each side Ergonomic bent-knee design Anti-slip foot post Includes 95 kg & shroud
	Weight: 210 kg Dimensions: L 142.2 x W 162.5 x H 157.5 cm Warranty: Full Commercial (P. 119)	
STH1100G-2	Pro Clubline Inner or Outer Thigh 95 kg Weight Stack	€ 3395.00
STH1100G-3	Pro Clubline Inner or Outer Thigh 140 kg Weight Stack	€ 3545.00



PRO CLUBLINE CABLE CROSSOVER		SPECIFICATIONS
	ITEM#: SCC1200G	<ul style="list-style-type: none"> • 5 X 10 cm steel mainframe • Independent weight stacks • Fully adjustable pivoting pulleys
	Weight: 305.2 kg Dimensions: L 396.2 x W 89 x H 231 cm Warranty: In-Home Lifetime / Full Commercial (P. 119)	
SCC1200-1	Pro Clubline Cable Crossover 75 kg Weight Stack	€ 4695.00
SCC1200-2	Pro Clubline Cable Crossover 105 kg Weight Stack	€ 4895.00
OPTIONAL ATTACHMENTS		
GCA2	Optional Lat Pull-Up / Chin-Up Station	€ 59.00



PRO CLUBLINE DUAL CABLE COLUMN		SPECIFICATIONS
	ITEM#: SDC2000G	<ul style="list-style-type: none"> • 5 x 10 cm Steel Mainframe • Extra-tough, tear-resistant DuraFirm™ • Dual weight stacks • In only a 3' x 4' area, you can perform an unlimited amount of exercises
	Weight: 306.2 Dimensions: L 99 x W 116.8 x H 231 cm Warranty: Full Commercial (P. 119)	
SDC2000G-1	Pro Clubline Dual Cable Column 75 kg Weight Stack	€ 4295.00
SDC2000G-2	Pro Clubline Dual Cable Column 105 kg Weight Stack	€ 4495.00



	<p>PRO CLUBLINE FOUR-STACK GYM</p> <p>ITEM#: S1000</p> <p>Weight: 784 kg</p> <p>Dimensions: L 315 x W 343 x H 210.8 cm</p> <p>Warranty: Full Commercial (P. 119)</p>	<p>SPECIFICATIONS</p> <ul style="list-style-type: none"> • 4 independent stations: • Chest press / Mid Row • Leg Extensions / Standing Leg Curl • Leg Press / Calf Press • Adjustable Cable Column • 4x 95 kg fully-shrouded weight stack, upgradable to 140 kg
<p>S1000</p>	<p>Pro Clubline Four-Stack Gym</p>	<p>€ 8995.00</p>
	<p>PRO CLUBLINE PROFESSIONAL LEGPRESS (45°)</p> <p>ITEM#: GLPH2100</p> <p>Weight: 182 kg</p> <p>Dimensions: L 211 x W 86 x H 142 cm - Ø 50 mm</p> <p>Warranty: Full Commercial (P. 119)</p>	<p>SPECIFICATIONS</p> <p>FC FULL COMMERCIAL RATED</p> <ul style="list-style-type: none"> • Quick flip-and-lock mechanism • Extra-heavy gauge diamond plate foot platforms • Easy-access under-carriage plate load system • Heavy-duty 5 x 10 cm 11-gauge steel mainframe • Ultra-tough 10 cm DuraFirm™ back & shoulder pads • Three lockout positions for safety and convenience
<p>GLPH2100</p>	<p>Pro Clubline Professional Leg Press (45°)</p>	<p>€ 3295.00</p>
	<p>PRO CLUBLINE COUNTER BALANCED</p> <p>ITEM#: SCB1000</p> <p>Weight: 247 kg</p> <p>Dimensions: L 127 x W 218.4 x H 213.4 cm</p> <p>Warranty: Full Commercial (P. 119)</p>	<p>SPECIFICATIONS</p> <p>FC FULL COMMERCIAL RATED</p> <ul style="list-style-type: none"> • Oval 11 gauge steel tubing • Counter-Balanced to 2.7 kg starting weight • 450 kg capacity • Seven degree angle for improved biomechanics
<p>SCB1000</p>	<p>Pro Clubline Counter Balanced Machine</p>	<p>€ 3795.00</p>
	<p>PRO CLUBLINE MULTI RACK POWER SYSTEM</p> <p>ITEM#: SMR1000</p> <p>Weight: 156 kg</p> <p>Dimensions: L 203.2 x W 180.3 x H 226 cm</p> <p>Warranty: Full Commercial (P. 119)</p>	<p>SPECIFICATIONS</p> <p>FC FULL COMMERCIAL RATED</p> <ul style="list-style-type: none"> • Solid steel gunrack liftoffs • 5 x 7.6 cm 11 gauge steel safeties & mainframe • Plate storage is included • 450 kg capacity • Integrated chinning bar and strength band pegs • Extended frame for spotter access
<p>SMR1000</p>	<p>Pro Clubline Multi Rack Power System</p>	<p>€ 1795.00</p>
	<p>PRO CLUBLINE LEVERAGE T-BAR ROW</p> <p>ITEM#: STBR500</p> <p>Weight: 74 kg</p> <p>Dimensions: L 197 x W 108 x H 46.5 cm</p> <p>Warranty: Full Commercial (P. 119)</p>	<p>SPECIFICATIONS</p> <p>FC FULL COMMERCIAL RATED</p> <ul style="list-style-type: none"> • Oversized diamond-plated footplate • Large integrated Olympic weight horn • 5 cm of knurl on each side of handle • Eyelet attachment for cable bars • 11-Gauge steel construction
<p>STBR500</p>	<p>Pro Clubline Leverage T-Bar Row</p>	<p>€ 795.00</p>
	<p>PRO CLUBLINE AB BENCH</p> <p>ITEM#: SAB500</p> <p>Weight: 56.7 kg</p> <p>Dimensions: L 175 x W 66.6x H 124 cm</p> <p>Warranty: Full Commercial (P. 119)</p>	<p>SPECIFICATIONS</p> <p>FC FULL COMMERCIAL RATED</p> <ul style="list-style-type: none"> • Gas assisted adjustment • 4 Point Base eliminates rocking • Transport wheels and handle • Oval 11 gauge steel frame
<p>SAB500</p>	<p>Pro Clubline Commercial Ab Bench</p>	<p>€ 895.00</p>
	<p>PRO CLUBLINE GLUTE HAM MACHINE</p> <p>ITEM#: SGH500</p> <p>Weight: 62 kg</p> <p>Dimensions: L 195.8 x W 82.8 x H 125.9 cm</p> <p>Warranty: Full Commercial (P. 119)</p>	<p>SPECIFICATIONS</p> <p>FC FULL COMMERCIAL RATED</p> <ul style="list-style-type: none"> • Vertical and horizontal adjustments ensure proper fit for any size user • Isolates lower posterior muscles • Works glutes, hamstrings, calves, abs and obliques in one machine • Step for easy access / Oversized pads
<p>SGH500</p>	<p>Pro Clubline Glute Ham Developer</p>	<p>€ 995.00</p>



	PRO CLUBLINE LEVERAGE SQUAT		SPECIFICATIONS
	ITEM#: SLS500		<ul style="list-style-type: none"> • Biomechanically Correct Angled Squat Platform • Rounded Calf Block Provides Extra Range of Motion • Oval 11 Gauge Steel Frame • Plate Storage Horns
Weight: 180.5 kg			
Dimensions: L 189 x W 155.7 x H 170.8 cm / Ø 50 mm			
Warranty: Full Commercial (P. 119)			
SLS500	Pro Clubline Leverage Squat Machine	Weights & clips not included	€ 2495.00



	PRO CLUBLINE OLYMPIC BENCH		SPECIFICATIONS
	ITEM#: SDB351G		<ul style="list-style-type: none"> • 5 x 7.6 cm Mainframe Construction • Gun Rack style bar holder • 11 Gauge Steel Mainframe • 6 mm Zinc Gun Rack
Weight: 55.8 kg			
Dimensions: L 190.5 x W 127 x H 127 cm			
Warranty: Full Commercial (P. 119)			
SDB351G	Pro Clubline Decline Olympic Bench		€ 895.00

	PRO CLUBLINE OLYMPIC FLAT BENCH		SPECIFICATIONS
	ITEM#: SFB349G		<ul style="list-style-type: none"> • 5 x 7.6 cm Mainframe Construction • Gun Rack style bar holder • 11 Gauge Steel Mainframe • 6 mm Zinc Gun Rack
Weight: 50.4 kg			
Dimensions: L 172.7 x W 127 x H 121.9 cm			
Warranty: Full Commercial (P. 119)			
SFB349G	Pro Clubline Flat Olympic Flat Bench		€ 895.00

	PRO CLUBLINE OLYMPIC INCLINE BENCH		SPECIFICATIONS
	ITEM#: SIB359G		<ul style="list-style-type: none"> • 5 x 7.6 cm Mainframe Construction • Gun Rack style bar holder • 11 Gauge Steel Mainframe • 6 mm Zinc Gun Rack
Weight: 56 kg			
Dimensions: L 155 x W 127 x H 157.5 cm			
Warranty: Full Commercial (P. 119)			
SIB359G	Pro Clubline Incline Olympic Bench		€ 895.00

	PRO CLUBLINE OL. SHOULDER PRESS BENCH		SPECIFICATIONS
	ITEM#: SPB368G		<ul style="list-style-type: none"> • 5 x 7.6 cm Mainframe Construction • Gun Rack style bar holder • 11 Gauge Steel Mainframe • 6 mm Zinc Gun Rack
Weight: 55 kg			
Dimensions: L 106.7 x W 127 x H 183 cm			
Warranty: Full Commercial (P. 119)			
SPB368G	Pro Clubline Shoulder Press Olympic Bench		€ 895.00

	PRO CLUBLINE DECLINE OLYMPIC BENCH		SPECIFICATIONS
	ITEM#: SODB250		<ul style="list-style-type: none"> • Weight capacity: 450 kg • Ideal for decline bench presses and other chest press movements • -18° Backrest angle • Adjustable leg hold positions
Weight: 67 kg			
Dimensions: L 146 x W 126 x H 138 cm			
Warranty: Full Commercial (P. 119)			
SODB250	Pro Clubline decline Olympic bench		€ 795.00

	PRO CLUBLINE FLAT OLYMPIC BENCH		SPECIFICATIONS
	ITEM#: SOFB250		<ul style="list-style-type: none"> • Spotter Stand included • Durable double-stitched upholstery • Backpad is 445 mm off the ground • Backpad Width: 292 mm • Weight capacity: 450 kg
Weight: 74.5 kg			
Dimensions: L 184 x W 126 x H 130 cm			
Warranty: Full Commercial (P. 119)			
SOFB250	Pro Clubline flat Olympic bench		€ 750.00

	PRO CLUBLINE INCLINE OLYMPIC BENCH		SPECIFICATIONS
	ITEM#: SOIB250	FC FULL COMMERCIAL RATED	<ul style="list-style-type: none"> • 30° backrest angle and adjustable seat pad • Durable double-stitched upholstery • Spotter Stand included • Backpad Width: 292 mm • Heavy-duty 11-gauge mainframe • Weight Capacity: 450 kg
SOIB250	Pro Clubline incline Olympic bench		€ 895.00

	PRO CLUBLINE SHOULDER OLYMPIC BENCH		SPECIFICATIONS
	ITEM#: SOSB250	FC FULL COMMERCIAL RATED	<ul style="list-style-type: none"> • Safe and effective shoulder press movements • Durable double-stitched upholstery • Spotter Stand included • Heavy-duty 11-gauge mainframe • Weight Capacity: 450 kg
SOSB250	Pro Clubline Shoulder Olympic bench		€ 1195.00

	PRO CLUBLINE VERTICAL KNEE RAISE		SPECIFICATIONS
	ITEM#: SVKR1000	FC FULL COMMERCIAL RATED	<ul style="list-style-type: none"> • Multiple Close and Wide Grips • Rock Climbing Grips • Revolving Dip Handles (move out of the way for other exercises) • Multiple Steps for Easy Access • Oval Heavy Gauge Steel Frame
SVKR1000	Pro Clubline Vertical Knee Raise Chin Dip		€ 2295.00



	PRO CLUBLINE INCLINE/DECLINE FLAT BENCH		SPECIFICATIONS
	ITEM#: SFID325	FC FULL COMMERCIAL RATED	<ul style="list-style-type: none"> • 5x7.6 cm eleven-gauge steel • 450 kg capacity • Back pad adjusts flat, incline (15, 30, 45, 60 and 80 °) and decline (-18 °) • Seat pad adjusts flat, 10, and 18 ° • Independent back pad and seat pad adj.
SFID325	Pro Clubline Flat / Incline / Decline Bench		€ 595.00

	PRO CLUBLINE INCLINE/DECLINE FLAT BENCH		SPECIFICATIONS
	ITEM#: SFID325B	FC FULL COMMERCIAL RATED	<ul style="list-style-type: none"> • 5x7.6 cm 11-gauge steel • 450 kg capacity • Back pad adjusts flat, incline (15, 30, 45, 60 & 80 °) decline (-18 °) • Seat pad adjusts flat, 10, and 18 ° • Independent back pad and seat pad adj. • Color: black
SFID325B	Pro Clubline Flat / Incline / Decline Bench		€ 595.00

	PRO CLUBLINE ADJUSTABLE BENCH		SPECIFICATIONS
	ITEM#: SFID425	FC FULL COMMERCIAL RATED	<ul style="list-style-type: none"> • 450 kg capacity • Back pad adjusts flat, incline (15, 30, 45, 60 and 80 °) and decline (-18 °) • Seat pad adjusts flat, 10, and 18 ° • Leg hold down to perform decline presses, sit-ups and more
SFID425	Pro Clubline Flat / Incline / Decline Bench		€ 635.00

	PRO CLUBLINE WEIGHT TREE BAR HOLDER		SPECIFICATIONS
	ITEM#: SWT1000	FC FULL COMMERCIAL RATED	<ul style="list-style-type: none"> • 12 chrome weight posts • 4 Integrated Olympic bar holders • 2 Integrated Olympic collar holders • Perfect for bumper plates • Oval 11 gauge steel frame
SWT1000	Pro Clubline Olympic Weight Tree Bar Holder	Weight plates not included!	€ 895.00

	PRO CLUBLINE SPOTTER STAND		SPECIFICATIONS	
	ITEM#: SPS12	FC FULL COMMERCIAL RATED		
	Weight: 8 kg			
	Dimensions: L 61 x W 32 x H 7 cm			
	Warranty: Full Commercial (P. 119)			
SPS12	Pro Clubline Spotter Stand			€ 65.00



	PRO CLUBLINE MODULAR STORAGE SYSTEM MODELS		SPECIFICATIONS	
	ITEM#: SDKR	FC FULL COMMERCIAL RATED	• Weights & Balls not included	
	Warranty: Full Commercial (P. 119)			
	SDKRDBS	Pro Clubline Small Dumbbell Shelf	22 kg	€ 235.00
	SDKRDBL	Pro Clubline Large Dumbbell Shelf	25 kg	€ 245.00
	SDKRKB	Pro Clubline Kettlebell Shelf	17 kg	€ 200.00
	SDKRMB	Pro Clubline Medicine Ball Shelf	6.5 kg	€ 125.00
	SDKRSD6	Pro Clubline Saddle Dumbbell Rack 6 spots	17.8 kg	€ 210.00
	SDKRSD8	Pro Clubline Saddle Dumbbell Rack 8 spots	18.5 kg	€ 220.00
	SDKRUP2	Pro Clubline Uprights 2 Tiers	14.2 kg	€ 225.00
	SDKRUP3	Pro Clubline Uprights 3 Tiers	15.5 kg	€ 315.00



	PRO CLUBLINE DUMBBELL RACK		SPECIFICATIONS	
	ITEM#: SDKR500DB	FC FULL COMMERCIAL RATED	SDKR500DB Includes: • 2-SDKRUP2 2-Tier Uprights • 2-SDKRDBS Small Dumbbell Shelves	
	Weight: N/A			
	Dimensions: L 177.5 x W 75 x H 68.8 cm			
	Warranty: Full Commercial (P. 119)			
SDKR500DB	Pro Clubline Dumbbell Rack			€ 920.00



	PRO CLUBLINE DUMBBELL RACK		SPECIFICATIONS	
	ITEM#: SDKR1000DB	FC FULL COMMERCIAL RATED	SDKR1000DB Includes: • 2-SDKRUP2 2-Tier Uprights • 3-SDKRDBS Small Dumbbell Shelves	
	Weight: N/A			
	Dimensions: L 177.5 x W 82.6 x H 109.5 cm			
	Warranty: Full Commercial (P. 119)			
SDKR1000DB	Pro Clubline Dumbbell Rack			€ 1335.00

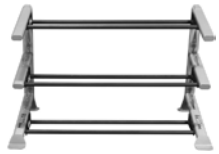

	PRO CLUBLINE SADDLE DUMBBELL RACK		SPECIFICATIONS	
	ITEM#: SDKR500SD	FC FULL COMMERCIAL RATED	SDKR500SD Includes: • 2-SDKRUP2 2-Tier Uprights • 1-SDKRSD6 Dumbbell Saddle (6 spots) • 1-SDKRSD8 Dumbbell Saddle (8 spots)	
	Weight: 64.41 kg			
	Dimensions: L 177.5 x W 875 x H 68.8 cm			
	Warranty: Full Commercial (P. 119)			
SDKR500SD	Pro Clubline Saddle Dumbbell Rack			€ 875.00



	PRO CLUBLINE SADDLE DUMBBELL RACK		SPECIFICATIONS	
	ITEM#: SDKR1000SD	FC FULL COMMERCIAL RATED	SDKR1000SD Includes: • 2-SDKRUP3 3-Tier Uprights • 2-SDKRSD6 Dumbbell Saddle (6 spots) • 1-SDKRSD8 Dumbbell Saddle (8 spots)	
	Weight: 99.8 kg			
	Dimensions: L 177.5 x W 82.6 x H 109.5 cm			
	Warranty: Full Commercial (P. 119)			
SDKR1000SD	Pro Clubline Saddle Dumbbell Rack			€ 1270.00

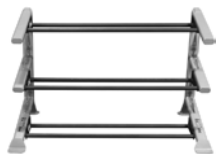

	PRO CLUBLINE MEDICINE BALL RACK		SPECIFICATIONS
	ITEM#: SDKR500MB		SDKR500MB includes: • 2-SDKRUP2 2-Tier Uprights • 2-SDKRMB Medicine Ball Shelves
	Weight: 64.4 kg		
	Dimensions: L 177.5 x W 875 x H 68.8 cm		
	Warranty: Full Commercial (P. 119)		
SDKR500MB	Pro Clubline Medicine Ball Rack		€ 680.00



	PRO CLUBLINE MEDICINE BALL RACK		SPECIFICATIONS
	ITEM#: SDKR1000MB		SDKR1000MB includes: • 2-SDKRUP2 3-Tier Uprights • 3-SDKRMB Medicine Ball Shelves
	Weight: 99.8 kg		
	Dimensions: L 177.5 x W 82.6 x H 109.5 cm		
	Warranty: Full Commercial (P. 119)		
SDKR1000MB	Pro Clubline Medicine Ball Rack		€ 975.00



	PRO CLUBLINE KETTLEBELL RACK		SPECIFICATIONS
	ITEM#: SDKR500KB		SDKR500KB includes: • 2-SDKRUP2 2-Tier Uprights • 2-SDKRKB Kettlebell Shelves
	Weight: 64.4 kg		
	Dimensions: L 177.5 x W 75 x H 68.8 cm		
	Warranty: Full Commercial (P. 119)		
SDKR500KB	Pro Clubline Kettlebell Rack		€ 850.00



	PRO CLUBLINE KETTLEBELL RACK		SPECIFICATIONS
	ITEM#: SDKR1000KB		SDKR1000KB includes: • 2-SDKRUP2 2-Tier Uprights • 2-SDKRKB Kettlebell Shelves
	Weight: 99.8 kg		
	Dimensions: L 177.5 x W 82.6 x H 109.5 cm		
	Warranty: Full Commercial (P. 119)		
SDKR1000KB	Pro Clubline Kettlebell Rack		€ 1230.00



	PRO CLUBLINE SERIES II CROSS OVER		SPECIFICATIONS
	ITEM#: S2CCO		• 36 starting positions for both weight stacks • Integrated multi grip chinning bar • Fully shrouded • 2 x 72.5, 95 or 140 kg weight stacks available • Includes: 2 nylon cable handles, ankle strap and straight bar
	Weight: 446 kg		
	Dimensions: L 486 x W 146.3 x H 251.5 cm		
	Warranty: In-Home Lifetime / Full Commercial (P. 119)		
S2CCO-1	Pro Clubline II Cable Crossover Machine / 72.5 kg weight stack		€ 7495.00
S2CCO-2	Pro Clubline II Cable Crossover Machine / 95 kg weight stack		€ 7595.00



	PRO CLUBLINE FUNCTIONAL TRAINER		SPECIFICATIONS
	ITEM#: S2FT-1		• 34 starting positions for both weight stacks • Integrated chinning bar • 72.5, 95 or 140 kg weight stacks available • Includes 109 cm revolving straight bar, 35 cm athletic bar, 2 nylon cable handles, ankle strap and straight bar
	Weight: 384.8 kg		
	Dimensions: L 201.7 x W 137 x H 251.5 cm		
	Warranty: In-Home Lifetime / Full Commercial (P. 119)		
S2FT-1	Pro Clubline Functional Trainer / 72.5 kg weight stack		€ 6450.00
S2FT-2	Pro Clubline Functional Trainer / 95 kg weight stack		€ 6500.00
S2FT-3	Pro Clubline Functional Trainer / 140 kg weight stack		



	PRO CLUBLINE II CABLE COLUMN		SPECIFICATIONS
	ITEM#: S2CC		<ul style="list-style-type: none"> • 36 starting positions • Fully shrouded • 72.5, 95 or 140 kg weight stack available • 5 x 7.6 cm 11 Gauge Steel Frame • Includes: nylon cable handle, ankle strap and straight bar
	Weight: 216.5 kg		
Dimensions: L 134.5 x W 146.3 x H 251.5 cm			
	Warranty: In-Home Lifetime / Full Commercial (P. 119)		
S2CC-1	Pro Clubline Series II Cable Column / 72.5 kg weight stack		€ 3595.00
S2CC-2	Pro Clubline Series II Cable Column / 95 kg weight stack		€ 3650.00



	PRO CLUBLINE II AB & BACK MACHINE		SPECIFICATIONS
	ITEM#: S2ABB		<ul style="list-style-type: none"> • Full Commercial (P. 119) rated • 5 x 7.6 cm 11 Gauge Steel Frame • Fully shrouded • Instructional Placards
	Weight: 164 kg		
Dimensions: L 149.2 x W 124.6 x H 144.7 cm			
	Warranty: In-Home Lifetime / Full Commercial (P. 119)		
S2ABB-1	Pro Clubline Series II Ab / Back Machine / 72.5 kg weight stack		€ 3095.00
S2ABB-2	Pro Clubline Series II Ab / Back Machine / 105 kg weight stack		€ 3295.00



	PR CLUB LINE II ARM CURL		SPECIFICATIONS
	ITEM#: S2AC		<ul style="list-style-type: none"> • Full Commercial (P. 119) rated • 5 x 7.6 cm 11 Gauge Steel Frame • Fully shrouded • Instructional Placards
	Weight: 176 kg		
Dimensions: L 103.2 x W 128.4 x H 144.4 cm			
	Warranty: In-Home Lifetime / Full Commercial (P. 119)		
S2AC-1	Pro Clubline Series II Arm Curl / 72.5 kg Weight Stack		€ 3095.00
S2AC-2	Pro Clubline Series II Arm Curl / 105 kg Weight Stack		€ 3295.00



	PRO CLUBLINE II WEIGHT ASSISTED CHIN DIP		SPECIFICATIONS
	ITEM#: S2ACD		<ul style="list-style-type: none"> • 105 kg weight stack • 5 different grips for pull ups and chin ups • Dip handles rotate out of the way for the other exercises • Solid guide rods with sealed bearings • Multiple steps for easy access
	Weight: 276 kg		
Dimensions: L 160 x W 111.8 x H 223.5 cm			
	Warranty: In-Home Lifetime / Full Commercial (P. 119)		
S2ACD-2	Pro Clubline Series II Weight Assisted Chin Dip / 105 kg Weight Stack		€ 4395.00



	PRO CLUBLINE II BICEPS/TRICEPS		SPECIFICATIONS
	ITEM#: S2BTP		<ul style="list-style-type: none"> • Full Commercial (P. 119) rated • 5 x 7.6 mm eleven-gauge steel • Fully shrouded • Instructional Placards
	Weight: 1212 kg		
Dimensions: L 131.4 x W 107.5 x H 211.8 cm			
	Warranty: In-Home Lifetime / Full Commercial (P. 119)		
S2BTP-1	Pro Clubline Series II Biceps/Triceps 72.5 kg Weight Stack		€ 3295.00
S2BTP-2	Pro Clubline Series II Biceps/Triceps 105 kg Weight Stack		€ 3395.00



	PRO CLUBLINE II CHEST PRESS		SPECIFICATIONS
	ITEM#: S2CP		<ul style="list-style-type: none"> • Full Commercial (P. 119) rated • 5 x 7.6 mm eleven-gauge steel • Fully shrouded • Instructional Placards
	Weight: 237 kg		
Dimensions: L 111.4 x W 139 x H 174.4 cm			
	Warranty: In-Home Lifetime / Full Commercial (P. 119)		
S2CP-2	Pro Clubline Series II Chest Press 95 kg Weight Stack		€ 3495.00
S2CP-3	Pro Clubline Series II Chest Press 140 kg Weight Stack		€ 3695.00



PROCLUBLINE II INNER/OUTER THIGH		SPECIFICATIONS
	ITEM#: S2IOT Weight: 1780 kg Dimensions: L 195.6 x W 94 x H 144.7 cm Warranty: In-Home Lifetime / Full Commercial (P. 119)	 <ul style="list-style-type: none"> • Full Commercial (P. 119) rated • 5 x 7.6 mm eleven-gauge steel • Fully shrouded • Instructional Placards
	S2IOT-1 Pro Clubline Series II Inner/Outer Thigh 72.5 kg Weight Stack € 3095.00	
S2IOT-2 Pro Clubline Series II Inner/Outer Thigh 105 kg Weight Stack € 3195.00		



PRO CLUBLINE II LAT PULL ROW		SPECIFICATIONS
	ITEM#: S2LAT Weight: 189 kg Dimensions: L 221.7 x W 84.4 x H 219.8 cm Warranty: In-Home Lifetime / Full Commercial (P. 119)	 <ul style="list-style-type: none"> • Full Commercial (P. 119) rated • 5 x 7.6 mm eleven-gauge steel • Fully shrouded • Instructional Placards
	S2LAT-1 Pro Clubline Series II Lat Pull Row 72.5 kg Weight Stack € 3095.00	
S2LAT-2 Pro Clubline Series II Lat Pull Row 105 kg Weight Stack € 3195.00		



PROCLUBLINE II LEG CURL/LEG EXTENSION		SPECIFICATIONS
	ITEM#: S2LEC Weight: 216.6 kg Dimensions: L 137 x W 131 x H 144.7 cm Warranty: In-Home Lifetime / Full Commercial (P. 119)	 <ul style="list-style-type: none"> • 5 x 7.6 mm eleven-gauge steel • Performs two important leg exercises from one comfortable position • Strengthen quads, glutes, hamstrings • Transition between movements simple and easy
	S2LEC-1 Pro Clubline Series II Curl /Leg Extension 72.5 kg Weight Stack € 3295.00	
S2LEC-2 Pro Clubline Series II Curl /Leg Extension 105 kg Weight Stack € 3495.00		



PRO CLUBLINE II LEG EXTENSION		SPECIFICATIONS
	ITEM#: S2LEX Weight: 190.6 kg Dimensions: L 119 x W 131.2 x H 144.7 cm Warranty: In-Home Lifetime / Full Commercial (P. 119)	 <ul style="list-style-type: none"> • Full Commercial (P. 119) rated • 5 x 7.6 mm eleven-gauge steel • Fully shrouded • Instructional Placards
	S2LEX-1 Pro Clubline Series II Leg Extension 72.5 kg Weight Stack € 3195.00	
S2LEX-2 Pro Clubline Series II Leg Extension 105 kg Weight Stack € 3495.00		



PRO CLUBLINE II LEG PRESS / CALF RAISE		SPECIFICATIONS
	ITEM#: S2LPC Weight: 223 kg Dimensions: L 210.3 x W 118.7 x H 174.7 cm Warranty: In-Home Lifetime / Full Commercial (P. 119)	 <ul style="list-style-type: none"> • Full Commercial (P. 119) rated • 5 x 7.6 mm eleven-gauge steel • Fully shrouded • Instructional Placards
	S2LPC-2 Pro Clubline Series II Leg Press/Calf Raise 95 kg Weight Stack € 3795.00	
S2LPC-3 Pro Clubline Series II Leg Press/Calf Raise 140 kg Weight Stack € 3995.00		



PRO CLUBLINE II MULTI PRESS		SPECIFICATIONS
	ITEM#: S2MP Weight: 216 kg Dimensions: L 182.6 x W 136 x H 144.7 cm Warranty: In-Home Lifetime / Full Commercial (P. 119)	 <ul style="list-style-type: none"> • Full Commercial (P. 119) rated • 5 x 7.6 mm eleven-gauge steel • Fully shrouded • Instructional Placards
	S2MP-2 Pro Clubline Series II Multi Press 95 kg Weight Stack € 3695.00	
S2MP-3 Pro Clubline Series II Multi Press 140 kg Weight Stack € 3895.00		



PRO CLUBLINE II PEC FLY - REAR DELTS		SPECIFICATIONS
	ITEM#: S2PEC Weight: 221.5 kg Dimensions: L 147.1 x W 148.3 x H 182 cm Warranty: In-Home Lifetime / Full Commercial (P. 119)	 <ul style="list-style-type: none"> • Full Commercial (P. 119) rated • 5 x 7.6 mm eleven-gauge steel • Fully shrouded • Instructional Placards
	S2PEC-1 Pro Clubline Series II Pec Fly - Rear Delts 95 kg Weight Stack € 3595.00	
S2PEC-2 Pro Clubline Series II Pec Fly - Rear Delts 140 kg Weight Stack € 3795.00		



PRO CLUBLINE II SEATED LEG CURL		SPECIFICATIONS
	ITEM#: S2SLC Weight: 198 kg Dimensions: L 144.1 x W 131.2 x H 144.7 cm Warranty: In-Home Lifetime / Full Commercial (P. 119)	 <ul style="list-style-type: none"> • Full Commercial (P. 119) rated • 5 x 7.6 mm eleven-gauge steel • Fully shrouded • Instructional Placards
	S2SLC-1 Pro Clubline Series II Seated Leg Curl 72.5 kg Weight Stack € 3595.00	
S2SLC-2 Pro Clubline Series II Seated Leg Curl 105 kg Weight Stack € 3895.00		



PRO CLUBLINE II SHOULDERS PRESS		SPECIFICATIONS
	ITEM#: S2SP Weight: 187 kg Dimensions: L 138.3 x W 139.8 x H 144.7 cm Warranty: In-Home Lifetime / Full Commercial (P. 119)	 <ul style="list-style-type: none"> • Full Commercial (P. 119) rated • 6 seat adjustments for all size users • Multi-position hand grips • Fully shrouded • 5 x 7.6 mm twelve-gauge steel
	S2SP-2 Pro Clubline Series II Shoulders Press 95 kg Weight Stack € 3195.00	
S2SP-3 Pro Clubline Series II Shoulders Press 140 kg Weight Stack € 3495.00		



PRO CLUBLINE LEVERAGE BENCH PRESS		SPECIFICATIONS
	ITEM#: LVBP Weight: 76.8 kg Dimensions: L 175.2 x W 134.6 x H 76.2 cm - Ø 50 mm Warranty: Full Commercial (P. 119)	 <ul style="list-style-type: none"> • 5 x 7.6 cm 11 gauge steel mainframe • Durable double stitched upholstery • Sealed bearing pivot points • Adjustable press arms with gas assisted start positions • Converging & Independent press arm movement for advanced biomechanics
	LVBP Pro Clubline Leverage Bench Press € 1595.00	



PRO CLUBLINE LEVERAGE INCLINE BENCH PRESS		SPECIFICATIONS
	ITEM#: LVIP Weight: 76.8 kg Dimensions: L 180.3 x W 134.6 x H 104.1 cm - Ø 50 mm Warranty: Full Commercial (P. 119)	 <ul style="list-style-type: none"> • 5 x 7.6 cm 11 gauge steel mainframe • Durable double stitched upholstery • Sealed bearing pivot points • Adjustable gas assisted start positions/ seat pad • Converging & Independent press arm movement for advanced biomechanics
	LVIP Pro Clubline Leverage Incline Bench Press € 1695.00	



PRO CLUBLINE LEVERAGE LAT PULLDOWN		SPECIFICATIONS
	ITEM#: LVLA Weight: 83 kg Dimensions: L 193 x W 124.4 x H 213.4 cm - Ø 50 mm Warranty: Full Commercial (P. 119)	 <ul style="list-style-type: none"> • 5 x 7.6 cm 11 gauge steel mainframe • Durable double stitched upholstery • Sealed bearing pivot points • Gas assist seat pad & leg hold down pads • Dual axis, Independent, diverging arm movement • 360 degree articulating hand grips
	LVLA Pro Clubline Leverage Lat Pulldown € 2095.00	



	PRO CLUBLINE LEVERAGE LEG CURL		SPECIFICATIONS	
	ITEM#: LVLC		<ul style="list-style-type: none"> • 5 x 7.6 cm 11 gauge steel mainframe • Durable double stitched upholstery • Sealed bearing pivot points • Direct link-arm design for continuous R.O.M. • Adjustable foot roller • V-bench design provides hamstring isolation 	
Weight: 71.5 kg	Dimensions: L 188 x W 116.8 x H 66 cm - Ø 50 mm			
Warranty: Full Commercial (P. 119)				
LVLC	Pro Clubline Leverage Leg Curl			€ 1595.00



	PRO CLUBLINE LEVERAGE LEG EXTENSION		SPECIFICATIONS	
	ITEM#: LVLE		<ul style="list-style-type: none"> • 5 x 7.6 cm 11 gauge steel mainframe • Durable double stitched upholstery • Sealed bearing pivot points • Direct link-arm design for continuous R.O.M. • Adjustable foot roller • Gas assist back pad adjustment 	
Weight: 71.5 kg	Dimensions: L 172.7 x W 119.4 x H 101.6 cm - Ø 50 mm			
Warranty: Full Commercial (P. 119)				
LVLE	Pro Clubline Leverage Leg Extension			€ 1595.00



	PRO CLUBLINE LEVERAGE HORIZONTAL LEG PRESS		SPECIFICATIONS	
	ITEM#: LVLP		<ul style="list-style-type: none"> • 5 x 7.6 cm 11 gauge steel mainframe • Durable double stitched upholstery • Sealed bearing pivot points • Large pivoting footplate for correct foot position • Dual self aligning linear bearing seat carriage • Fully adjustable back support 	
Weight: 233.3 kg	Dimensions: L 221 x W 155 x H 142.2 cm - Ø 50 mm			
Warranty: Full Commercial (P. 119)				
LVLP	Pro Clubline Leverage Horizontal Leg Press			€ 4195.00



	PRO CLUBLINE LEVERAGE SHOULDER PRESS		SPECIFICATIONS	
	ITEM#: LVSP		<ul style="list-style-type: none"> • 5 x 7.6 cm 11 gauge steel mainframe • Durable double stitched upholstery • Sealed bearing pivot points • Adjustable gas assisted start positions/seat pad • Converging & Independent press arm movement for advanced biomechanics 	
Weight: 78 kg	Dimensions: L 124.5 x W 134.6 x H 132 cm - Ø 50 mm			
Warranty: Full Commercial (P. 119)				
LVSP	Pro Clubline Leverage Shoulder Press			€ 1595.00



	PRO CLUBLINE LEVERAGE SEATED ROW		SPECIFICATIONS	
	ITEM#: LVSR		<ul style="list-style-type: none"> • 5 x 7.6 cm 11 gauge steel mainframe • Durable double stitched upholstery • Sealed bearing pivot points • Gas assist seat pad & chest support • Dual axis, Independent, diverging arm movement • 360 degree articulating hand grips 	
Weight: 72 kg	Dimensions: L 165 x W 90 x H 111.7 cm - Ø 50 mm			
Warranty: Full Commercial (P. 119)				
LVSR	Pro Clubline Leverage Seated Row			€ 1595.00



PRO DUAL AB & BACK		SPECIFICATIONS
	ITEM#: DABB-SF	 <ul style="list-style-type: none"> • Ø23 cm adjustable roller pad • Counterbalanced resistance arm has 14 starting points • Gas-assisted seat has 5 adjustable positions • 6-position adjustable leg pad/foot brace
	Weight: 220.5 kg	
	Dimensions: L 126.3 x W 121 x H 161 cm	
	Warranty: Full Commercial (P. 119)	
DABB-SF	Pro Dual Ab and Back with Frame & 95 kg Stack	€ 3395.00
OPTIONAL ATTACHMENTS		
SP300	OPTIONAL 140 kg Weight Stack	€ 850.00
SP300CH	OPTIONAL Extra Cost Changing Weight Stack from 95 kg to 140 kg	€ 350.00



PRO DUAL BICEPS TRICEPS		SPECIFICATIONS
	ITEM#: DBTC-SF	 <ul style="list-style-type: none"> • Adjustable, ergonomically designed arm pad • 5-position gas-assisted adjustable seat with back support, stable platform • 3-position pivoting handles • 14 combined adjustments
	Weight: 232.5 kg	
	Dimensions: L 111.6 x W 124.4 x H 161 cm	
	Warranty: Full Commercial (P. 119)	
DBTC-SF	Pro Dual Biceps Triceps with Frame & 95 kg Stack	€ 3495.00
OPTIONAL ATTACHMENTS		
SP300	OPTIONAL 140 kg Weight Stack	€ 850.00
SP300CH	OPTIONAL Extra Cost Changing Weight Stack from 95 kg to 140 kg	€ 350.00



PRO DUAL LEG & CALF PRESS		SPECIFICATIONS
	ITEM#: DCLP-SF	 <ul style="list-style-type: none"> • Recumbent seat with 12 position adjustable back pad • 2:1 weight ratio • Wide rubber, matted non-skid press plate • Conveniently placed handgrips
	Weight: 253.5 kg	
	Dimensions: L 205 x W 95 x H 212.5 cm	
	Warranty: Full Commercial (P. 119)	
DCLP-SF	Pro Dual Leg Press Calf Press with Frame & 95 kg Stack	€ 3895.00
OPTIONAL ATTACHMENTS		
SP300	OPTIONAL 140 kg Weight Stack	€ 850.00
SP300CH	OPTIONAL Extra Cost Changing Weight Stack from 95 kg to 140 kg	€ 350.00



PRO DUAL INNER OUTER THIGH		SPECIFICATIONS
	ITEM#: DIOT-SF	 <ul style="list-style-type: none"> • Ergonomically correct forward-facing weight stack • Extra large rotating kneepads • 9-position seat back adjustments and dual, non-skid foot posts • Easy to reach pop-pin leg adjustments
	Weight: 215.7 kg	
	Dimensions: L 193 x W 91.6 x H 161 cm	
	Warranty: Full Commercial (P. 119)	
DIOT-SF	Pro Dual Inner Outer Thigh Machine w Frame & 95 kg Stack	€ 3795.00
OPTIONAL ATTACHMENTS		
SP300	OPTIONAL 140 kg Weight Stack	€ 850.00
SP300CH	OPTIONAL Extra Cost Changing Weight Stack from 95 kg to 140 kg	€ 350.00



PRO DUAL LAT MID ROW		SPECIFICATIONS
	ITEM#: DLAT-SF	 <ul style="list-style-type: none"> • Engineered with a high pulley directly overhead • No-cable-change design • Oversized Ø23 cm thigh pads • Non-skid foot brace and an extra-long seat pad for stability
	Weight: 244.3 kg	
	Dimensions: L 195.2 x W 118 x H 212.5 cm	
	Warranty: Full Commercial (P. 119)	
DLAT-SF	Pro Dual Lat Mid Row Machine with Frame & 95 kg Stack	€ 3695.00
OPTIONAL ATTACHMENTS		
SP300	OPTIONAL 140 kg Weight Stack	€ 850.00
SP300CH	OPTIONAL Extra Cost Changing Weight Stack from 95 kg to 140 kg	€ 350.00

	PRO DUAL LEG EXTENSION LEG CURL	SPECIFICATIONS
	ITEM#: DLEC-SF Weight: 233.6 kg Dimensions: L 117.8 x W 166.6 x H 161 cm Warranty: Full Commercial (P. 119)	 <ul style="list-style-type: none"> Engineered with a high pulley directly overhead No-cable-change design Oversized Ø23 cm thigh pads Non-skid foot brace and an extra-long seat pad for stability
DLEC-SF	Pro Dual Lat Mid Row Machine with Frame & 95 kg Stack	€ 3695.00
OPTIONAL ATTACHMENTS		
SP300	OPTIONAL 140 kg Weight Stack	€ 850.00
SP300CH	OPTIONAL Extra Cost Changing Weight Stack from 95 kg to 140 kg	€ 350.00

	PRO DUAL ADJUSTABLE CABLE COLUMN	SPECIFICATIONS
	ITEM#: DPCC-SF Weight: 205 kg Dimensions: L 109.6 x W 84.8 x H 212.5 m Warranty: Full Commercial (P. 119)	 <ul style="list-style-type: none"> Fully adjustable functional training with 18 positions Pivoting quad pulley carriage with dual handles Chrome vertical column
DPCC-SF	Pro Dual Adjustable Cable Column with Frame & 95 kg Stack	€ 2995.00
OPTIONAL ATTACHMENTS		
SP300	OPTIONAL 140 kg Weight Stack	€ 850.00
SP300CH	OPTIONAL Extra Cost Changing Weight Stack from 95 kg to 140 kg	€ 350.00

	PRO DUAL PEC REAR DELT	SPECIFICATIONS
	ITEM#: DPEC-SF Weight: 232.4 kg Dimensions: L 137.5 x W 95.6 x H 173.5 cm Warranty: Full Commercial (P. 119)	 <ul style="list-style-type: none"> Independent arms with 5 starting positions 360 degree rotating handles 5-position gas-assisted seat
DPEC-SF	Pro Dual Pec Rear Delt Machine with Frame & 95 kg Stack	€ 3495.00
OPTIONAL ATTACHMENTS		
SP300	OPTIONAL 140 kg Weight Stack	€ 850.00
SP300CH	OPTIONAL Extra Cost Changing Weight Stack from 95 kg to 140 kg	€ 350.00

	PRO DUAL VERTICAL PRESS & LAT	SPECIFICATIONS
	ITEM#: DPLS-SF Weight: 250.4 kg Dimensions: L 169.3 x W 117.9 x H 212 cm Warranty: Full Commercial (P. 119)	 <ul style="list-style-type: none"> Performs chest/incline/shoulder press exercise with back pad adjustability Lat pull down and mid row exercises Ergo grip press handles for correct positioning Adjustable press arm for full range of motion
DPLS-SF	Pro Dual Vertical Press & Lat with Frame & 95 kg Stack	€ 3995.00
OPTIONAL ATTACHMENTS		
SP300	OPTIONAL 140 kg Weight Stack	€ 850.00
SP300CH	OPTIONAL Extra Cost Changing Weight Stack from 95 kg to 140 kg	€ 350.00

	PRO DUAL MULTIPRESS	SPECIFICATIONS
	ITEM#: DPRS-SF Weight: 257.4 kg Dimensions: L 214.5 x W 141.7 x H 161 cm Warranty: Full Commercial (P. 119)	 <ul style="list-style-type: none"> 20-position adjustable seat and back pad slide in unison 5 cm of DuraFirm™ upholstery Pillow block bearing pivots Biomechanically designed for maximum muscle development
DPRS-SF	Pro Dual Multi Press Machine with Frame & 95 kg Stack	€ 3895.00
OPTIONAL ATTACHMENTS		
SP300	OPTIONAL 140 kg Weight Stack	€ 850.00
SP300CH	OPTIONAL Extra Cost Changing Weight Stack from 95 kg to 140 kg	€ 350.00

PRO DUAL BASE FRAME FOR DUAL MULTI STACK		SPECIFICATIONS
	ITEM#: DGYM	<ul style="list-style-type: none"> The 4 Stack Tower provides a solid foundation for any of the 10 different Pro Dual stations. 4 independent weight stations can be added 4 universal upper and lower station mounts 4 universal upper and lower pulley stations 4 easy mount chrome guide rods 95 kg & 140 kg weight stack option
	Weight: Tower with Weights: 536 kg Tower without Weights: 171.5 kg	
	Dimensions: L 94 x W 94 x H 210.8 cm	
	Warranty: Full Commercial (P. 119)	
DGYM	Pro Dual Base Frame for Pro Dual Multi-Stack (Center Frame & Shrouds)	€ 5995.00
OPTIONAL ATTACHMENTS		
DGYM MUST BE PURCHASED WITH 3-4 OPTIONAL STATIONS:		
DABB-S	Pro Dual Ab and Back for DGYM with 90 kg Stack	€ 1695.00
DBTC-S	Pro Dual Bicep Tricep for DGYM with 90 kg Stack	€ 1795.00
DCLP-S	Pro Dual Leg Press Calf Press for DGYM with 90 kg Stack	€ 1895.00
DIOT-S	Pro Dual Inner Outer Thigh for DGYM with 90 kg Stack	€ 2095.00
DLAT-S	Pro Dual Lat Mid Row for DGYM with 90 kg Stack	€ 1695.00
DLEC-S	Pro Dual Leg Extension Leg Curl for DGYM with 90 kg Stack	€ 1895.00
DPCC-S	Pro Dual Adjustable Cable Column for DGYM with 90 kg Stack	€ 1195.00
DPEC-S	Pro Dual Pec Rear Delt for DGYM with 290 kg Stack	€ 1795.00
DPLS-S	Pro Dual Vertical Press and Lat for DGYM with 90 kg Stack	€ 2095.00
DPRS-S	Pro Dual Multi Press for DGYM with 90 kg Stack	€ 2195.00
WEIGHT STACKS		
SP300	OPTIONAL 140 kg Weight Stack	€ 850.00
SP300CH	OPTIONAL Extra Cost Changing Weight Stack from 95 kg to 140 kg	€ 350.00



PRO SELECT BICEPS-TRICEPS MACHINE		SPECIFICATIONS
	ITEM#: GCBT-STK	<ul style="list-style-type: none"> Multi grip handle for overhand & underhand grip positions Ultra thick Duraform™ upholstery 7 position seat adjust. & 28 hole adjust. Adjustable arm can be positioned upward for triceps workout Standard with 95 kg stack – optional 140 kg stack
	Weight: 183.8 kg	
	Dimensions: L 130.3 x W 91.3 x H 178.5 cm	
	Warranty: In-Home Lifetime / Light Commercial (P. 119)	
GCBT-STK	Pro Select Biceps-Trieps Machine	€ 1895.00



PRO SELECT KNEE RAISE, DIP & CHIN MACHINE		SPECIFICATIONS
	ITEM#: FCD-STK	<ul style="list-style-type: none"> 5 x 7.6 cm Oval Mainframe Construction Multipositioning On Lat / Chin-Up Station Thick Duraform™ Upholstry Oversized Back Pad Assisted Pull Ups And Dips Dip Handle Width 56 cm
	Weight: 217 kg	
	Dimensions: L 165 x W 137 x H 210.8 cm	
	Warranty: In-Home Lifetime / Light Commercial (P. 119)	
FCD-STK	Pro Select Weight Assisted Knee Raise, Dip & Chin Up Station --Weight Stack: 95 kg	€ 1995.00



PRO SELECT AB-BACK MACHINE		SPECIFICATIONS
	ITEM#: GCAB-STK	<ul style="list-style-type: none"> Ultra thick Duraform™ upholstery Positioned at a 30° angle for precise biomechanical movement 5 x 10 cm mainframe steel 20 position adjustable cam for more range of motion
	Weight: 181 kg	
	Dimensions: L 137.8 x W 126 x H 178.5 cm	
	Warranty: In-Home Lifetime / Light Commercial (P. 119)	
GCAB-STK	Pro Select Ab/Back Machine	€ 1895.00

PRO SELECT LEG EXTENSION & CURL MACHINE		SPECIFICATIONS
	ITEM#: GCEC-STK	<ul style="list-style-type: none"> Duraform™ pads and oversized rollers 7 position adjustments on back pad and leg hold down to fit all size users Storage for leg hold down piece Distance from top of seat pad to bottom of foam roller (leg extension) 40.6 cm Biomechanically correct
	Weight: 191 kg	
	Dimensions: L 136.7 x W 137.5 x H 178.5 cm	
	Warranty: In-Home Lifetime / Light Commercial (P. 119)	
GCEC-STK	Pro Select Leg Extension & Curl Machine	€ 1895.00

PRO-SELECT

	PRO SELECT INNER & OUTER THIGH MACHINE		SPECIFICATIONS	
	ITEM#: GIOT-STK		<ul style="list-style-type: none"> • Combines both abductor and adductor exercises in one seated position • Adjustable back support • No cable change and with swiveling knee pads • Side stability handles for better positioning 	
Weight: 191 kg	Dimensions: L 158.7 x W 165 x H 177.8 cm			
Warranty: In-Home Lifetime / Light Commercial (P. 119)				
GIOT-STK	Pro Select Inner and Outer Thigh Machine		€ 1995.00	

	PRO SELECT LEG PRESS		SPECIFICATIONS	
	ITEM#: GLP-STK		<ul style="list-style-type: none"> • 2:1 Ratio • Rubber coated extra wide foot plate • Extra large press plate rotates both forward and downward to target thighs • Side stability handles for better positioning • Adjustable back support 	
Weight: 204.8 kg	Dimensions: L 160 x W 139.7 x H 177.8 cm			
Warranty: In-Home Lifetime / Light Commercial (P. 119)				
GLP-STK	Pro Select Leg Press With Stack		€ 1995.00	

	PRO SELECT PEC DECK WITH 95 KG STACK		SPECIFICATIONS	
	ITEM#: GMFP-STK		<ul style="list-style-type: none"> • User defined movements recruit stabilizer muscles for all pressing exercises • Pulleys rotate 180 ° allowing for workouts on a stability ball • Includes nylon cable handles • Adjustable seat pad ensures proper fit • Thick DuraFirm™ upholstery 	
Weight: N/A kg	Dimensions: L 193.3 x W 128 x H 178.3 cm			
Warranty: In-Home Lifetime / Light Commercial (P. 119)				
GMFP-STK	Pro Select Pec Deck with 95 kg Stack		€ 1895.00	

	PRO SELECT FRAME DOOR WITH 95 KG STACK		SPECIFICATIONS	
	ITEM#: STK		<ul style="list-style-type: none"> • For use with all Pro Select machines • Connection kit required! • The highest quality iron casting available. • Includes weight plates, selector and guide rods, frame and connecting hardware. 	
Weight: 133.5 kg	Dimensions: L 211 x W 143 x H 143 cm			
Warranty: In-Home Lifetime / Light Commercial (P. 119)				
STK	Pro Select Frame Door with 95 kg Stack		€ 950.00	
OPTIONAL ATTACHMENTS				
FCDBRKT	Kit for connection Door Frame - GSTCK to FCD		€ 75.00	
GCECBT-KIT	Kit for connection Door Frame - GSTCK to GCBT & GCEC		€ 199.00	
GCABBT-KIT	Kit for connection Door Frame - GSTCK to GCAB		€ 199.00	

	WEIGHT STACK ADD-ON-KIT		SPECIFICATIONS	
	ITEM#: SP50		<ul style="list-style-type: none"> • Takes the standard weight stack to a new level of performance. • Fast and simple installation make this a must-have for your plate load system. 	
Weight: 22.7 kg	Dimensions: L 26.5 x W 12.5 x H 2.3 cm (per piece)			
Warranty: Parts: 2 years				
SP50	Weight Stack Add-On-Kit 22.5 kg		€ 130.00	

	WEIGHT STACK ADD-ON-KIT		SPECIFICATIONS	
	ITEM#: WSP50		<ul style="list-style-type: none"> • Takes the standard weight stack to a new level of performance. • Fast and simple installation make this a must-have for your plate load system. • Only for PRO-DUAL and PRO-CLUBLINE 	
Weight: 27.7 kg	Dimensions: L 28.5 x W 11.3 x H 2.6 cm (per piece)			
Warranty: Parts: 2 years				
WSP50	WSP50 5 x WSP10		€ 165.00	
WSP15			€ 40.00	

	CABLE FOR BODY-SOLID POWERLINE			
	ITEM#: CABLE5	Dimensions: Ø5 mm	€ 3.00/meter	
	CABLE FOR PROFESSIONAL PRODUAL			
ITEM#: CABLE6	Dimensions: Ø6 mm	€ 3.50/meter		

	POWERLINE HALF RACK ITEM#: PPR500 Weight: 51.1 kg Dimensions: L 127.6 x W 129.3 x H 210.8 cm Warranty: Frame: 10 years - Parts: 2 years	SPECIFICATIONS <ul style="list-style-type: none"> • Customize and expand with attachments • Includes J-cups and safety spotter arms • 5 x 5 cm heavy gauge steel frame • 5 cm hole spacing for j-cups and safety spotter arms
	PPR500 Powerline Half Rack € 495.00	OPTIONAL PPR500EXT Powerline Half Rack Extension € 169.00



	POWERLINE HALF RACK EXTENSION ITEM#: PPR500EXT Weight: 17.6 kg Dimensions: (Attached): L 127.6 x W 129.3 x H 210.8 Warranty: Frame: 10 years - Parts: 2 years	SPECIFICATIONS <ul style="list-style-type: none"> • Optional attachment for PPR500 half rack • Extends PPR500 half rack without increased footprint • Additional space for optional attachments • 5 x 5 cm heavy gauge steel frame
	PPR500EXT Powerline Half Rack Extension € 169.00	



	POWERLINE POWER RACK ITEM#: PPR1000 Weight: 76.2 kg Dimensions: L 135.8 x W 129.3 x H 210.8 cm Warranty: Frame: 10 years - Parts: 2 years	SPECIFICATIONS <ul style="list-style-type: none"> • High-quality power rack • Customize and expand with attachments • Includes J-cups and pipe & pin safeties • 5 x 5 cm heavy gauge steel frame • 5 cm hole spacing for j-cups and pin and pipe safeties • Weight capacity: 300 kg
	PPR1000 Powerline PowerRack € 750.00	OPTIONAL PPR1000EXT Powerline Rack Extension for PPR1000 € 225.00

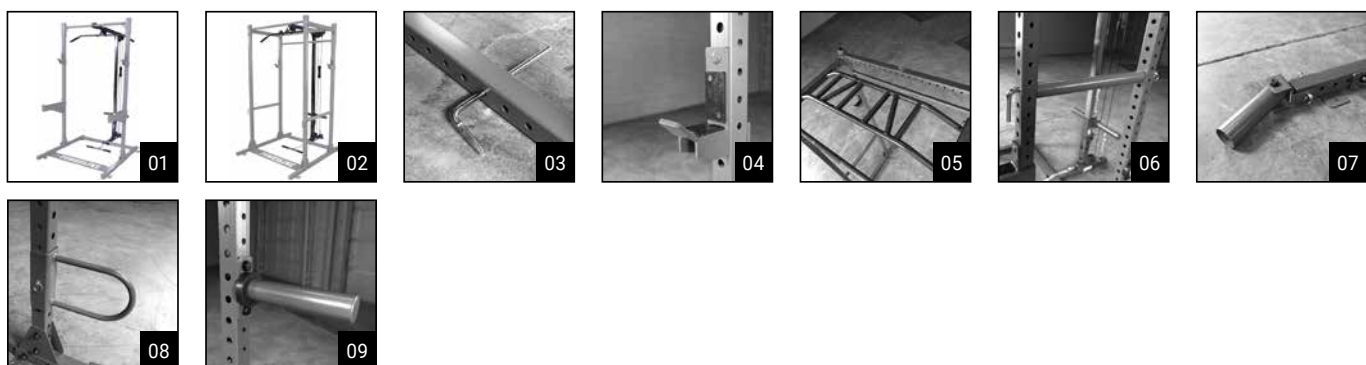

	POWERLINE RACK EXTENSION ITEM#: PPR1000EXT Weight: 22 kg Dimensions: (Attached): L 178 x W 129.3 x H 210.8 Warranty: Frame: 10 years - Parts: 2 years	SPECIFICATIONS <ul style="list-style-type: none"> • Optional attachment for PPR500 half rack • Extends PPR500 half rack without increased footprint • Additional space for optional attachments • 5 x 5 cm heavy gauge steel frame
	PPR1000EXT Powerline Half Rack Extension € 225.00	



OPTIONAL ATTACHMENTS PPR500 - PPR1000				KG	RETAIL
01	PLA500	PPR500	Lat Attachment	-	€ 495.00
02	PLA1000	PPR1000	Lat Attachment	20.95	€ 385.00
03	PPRBP	PPR500 / PPR1000	Band Peg		€ 12.00
04	PPRJC	PPR500 / PPR1000	J-Cups		€ 59.00
05	PPRCU	PPR500 / PPR1000	Multi-Chin Up		€ 95.00
06	PPRPS	PPR500	Safety Pin & Pipe Set		€ 74.00
07	PPRTB	PPR500 / PPR1000	T-Bar Row		€ 49.00
08	PPRUL	PPR500 / PPR1000	U-Link		€ 30.00
09	PPRWH	PPR500 / PPR1000	Weight Horn		€ 19.00







	PRO CLUBLINE COMMERCIAL SQUAT RACK	SPECIFICATIONS
	ITEM#: SPR250 Weight: 64 kg Dimensions: L 130 x W 151 x H 184.6 cm Warranty: In-Home Lifetime / Light Commercial (P. 119)	 <ul style="list-style-type: none"> Adjustable frame fits 150, 180 and 210 cm Olympic bars 5 x 7.5 cm 11-gauge steel 5 cm hole spacing for optional safety spotters Includes 2 premium J-cup liftoffs Weight Capacity: 450 kg
SPR250	Pro Clubline Commercial Squat Rack	€ 595.00



	PRO CLUBLINE COMMERCIAL HALF RACK	SPECIFICATIONS
	ITEM#: SPR500 Weight: 96 kg Dimensions: L 127.6 x W 133.5 x H 226.7 cm Warranty: Full Commercial (P. 119)	 <ul style="list-style-type: none"> 7.6 x 7.6 cm 11-gauge steel Mainframe Includes premium J-cup Liftoffs Includes safety Spotter Arms Integrated Chinning Bar More info on page 65
SPR500	Pro Clubline Commercial Power Half Rack Includes Liftoffs and Premium Safeties	€ 995.00
OPTIONAL		
SPR500HALFBACK	Rear Extension with 4 Weight Horns for SPR500	€ 695.00
SPRHLA	Lat Attachment	€ 595.00
SPRPLATFORM	Power Rack Floor Mat	€ 1395.00



	PRO CLUBLINE HALF RACK EXTENSION	SPECIFICATIONS
	ITEM#: SPR500HALFBACK Weight: 59.5 kg Dimensions: L 204.5 x W 65 x H 228.6 cm Warranty: Full Commercial (P. 119)	 <ul style="list-style-type: none"> Extends the SPR500 Half Rack without increasing the usage footprint Includes four weight horns Perfect place to add more storage for accessories Combine with pin and pipe safeties (SPRPS) for a rack pull station
SPR500HALFBACK	Pro Clubline Commercial Half Rack Extension	€ 695.00



	PRO CLUBLINE LAT ATTACHMENT FOR SPR500	SPECIFICATIONS
	ITEM#: SPRHLA Weight: 41 kg Dimensions: L 185.5 x W 134.6 x H 226 cm Warranty: Full Commercial (P. 119)	 <ul style="list-style-type: none"> Add workout variety & versatility to half rack Compatible only with the Body-Solid SPR500 and SPR500Back 1000 kg tested nylon-coated aircraft quality cables No cable change design Includes lat bar and a low row bar Full Commercial (P. 119) Warranty
SPRHLA	Pro Clubline Lat Attachment for SPR500	€ 595.00



	PRO CLUBLINE COMMERCIAL HALF RACK	SPECIFICATIONS
	ITEM#: SPR500BACK Weight: 156 kg Dimensions: L 127.6 x W 204.6 x H 227.6 cm Warranty: Full Commercial (P. 119)	 <ul style="list-style-type: none"> 7.6 x 7.6 cm 11-gauge steel Mainframe Includes premium J-cup Liftoffs Includes safety Spotter Arms Integrated Chinning Bar Includes expansion with 4 Weight Horns More info on page 65
SPR500BACK	Pro Clubline Commercial Half Rack Back	€ 1595.00
PACKAGE INCLUDES		
SPRJC	Premium J-Cup Liftoffs	€ 119.00
SPRSA	Safety Spotter Arms	€ 189.00
SPRDCB	Chinning Bar	€ 125.00
SR-WPH	4 Weight Horns	€ 55.00
OPTIONAL		
SPRPLATFORM	Power Rack Floor Mat	€ 1395.00

	PRO CLUBLINE COMMERCIAL DOUBLE HALF RACK	SPECIFICATIONS
	ITEM#: SPR500DBL Weight: 246.5 kg Dimensions: L 256.5 X W 216 X H 226 CM Warranty: In-Home Lifetime / Full Commercial (P. 119)	 <ul style="list-style-type: none"> 7.6 x 7.6 cm 11-gauge steel Mainframe 25 mm hole spacing for J-cups and safeties Includes (4) cup liftoffs, (4) safety spotter arms, (2) chinning bars and (6) weight horns Laser-cut numbers More info on page 65
SPR500DBL	Pro Clubline Commercial Double Half Rack	€ 2485.00

	PRO CLUBLINE POWER RACK		SPECIFICATIONS
	ITEM#: SPR1000		<ul style="list-style-type: none"> • Ø 7.6 cm 11-gauge steel Mainframe • 2.5 cm hole spacing for safety spotter bars • Expansion for weight storage and spotter access • Monkey bar expansion bolts two racks together
Weight: 158.76 kg	Dimensions: L 205.7 x W 134 x H 226.7 cm		More info on page 66
Dimensions: L 205.7 x W 134 x H 226.7 cm	Warranty: Full Commercial (P. 119)		
SPR1000	Pro Clubline Commercial Power Rack Includes Lift-offs and Premium Safeties		€ 1795.00
OPTIONAL			
SPRPLATFORM	Power Rack Floor Mat		€ 1395.00

	PRO CLUBLINE POWER RACK/EXTENSION		SPECIFICATIONS
	ITEM#: SPR1000BACK		<ul style="list-style-type: none"> • Ø 7.6 cm 11-gauge steel Mainframe • 2.5 cm hole spacing for safety spotter bars • Expansion for weight storage and spotter access • Monkey bar expansion bolts two racks together
Weight: 224 kg	Dimensions: L 236.2 x W 205.7 x H 228.6 cm		More info on page 66
Dimensions: L 236.2 x W 205.7 x H 228.6 cm	Warranty: Full Commercial (P. 119)		
SPR1000BACK	Pro Clubline Commercial Power Rack & Extension Includes SPR1000 & SPRBACK		€ 2495.00
OPTIONAL			
SPRPLATFORM	Power Rack Floor Mat		€ 1395.00

	PRO CLUBLINE DOUBLE POWER RACK		PACKAGE INCLUDES
	ITEM#: SPR1000DB		<ul style="list-style-type: none"> • Includes two complete SPR1000 Commercial Power Racks and the SPRMB Monkey Bar Cross Member • Ø 7.6 cm 11-gauge steel Mainframe • 2.5 cm hole spacing for safety spotter bars
Weight: 373 kg	Dimensions: L 205.7 x W 500 x H 238.8 cm		
Dimensions: L 205.7 x W 500 x H 238.8 cm	Warranty: Full Commercial (P. 119)		
SPR1000DB	Pro Clubline Commercial Double Power Racks with Monkey Bar Includes two SPR1000 & SPRMB		€ 3695.00
OPTIONAL			
SPRPLATFORM	Power Rack Floor Mat		€ 1395.00

	PRO CLUBLINE DOUBLE POWER RACK/EXTENSION		PACKAGE INCLUDES
	ITEM#: SPR1000DBBACK		<ul style="list-style-type: none"> • Includes two complete SPR1000BACK Commercial Extended Power Racks and the SPRMB Monkey Bar Cross Member • Ø 7.6 Cm 11-gauge steel mainframe • 2.5 Cm hole spacing for safety spotter bars • Includes expansion for weight storage and • Spotter access on both racks
Weight: 483.54 kg	Dimensions: L 236.2 x W 571.5 x H 238.8 cm		
Dimensions: L 236.2 x W 571.5 x H 238.8 cm	Warranty: Full Commercial (P. 119)		
SPR1000DBBACK	Pro Clubline Commercial Double Power Racks and Extension Includes two SPR1000, two SPRBACK & SPRMB		€ 5495.00
OPTIONAL ATTACHMENTS			
SPRPLATFORM	Power Rack Floor Mat		€ 1395.00

	OPTIONAL ATTACHMENTS SPR250 / SPR500 / SPR1000 / GPR400			NET/KG	GROSS/KG	RETAIL
01	SPRACB	SPR500 / SPR1000	Connecting Bar	23.5	24.5	€ 275.00
02	SPRBACK	SPR1000	Rack Extension Kit	N/A	N/A	€ 895.00
03	SPRBCB	SPR500	Bench Clearance Back Bar	8.3	10.5	€ 119.00
04	SPRBP	SPR500 / SPR1000	Band Pegs For	0.9	1.4	€ 55.00
05	SPRCB	SPR1000	Fat Chin-Up Bar	5.4	6.2	€ 79.00
06	SPRCUA	SPR1000	Multi-Grip Chin Bar	10.6	13.7	€ 249.00
07	SPRDCB	SPR500	Dual Chin-Up Bar	12.1	15	€ 125.00
08	SPRHLA	SPR500	Lat Attachment	41.3		€ 595.00
09	SPRHT	SPR250 / SPR500 / SPR1000 / GPR400	Hip Thrust Attachment	14	15	€ 175.00
10	SPRJAM	SPR1000	Jammer Arms	38.5	41.6	€ 395.00
11	SPRJC	SPR500 / SPR1000	J-Cups	7	7.6	€ 119.00
12	SPRMB	SPR1000	Monkey Bars	35.5	38.2	€ 449.00
13	SPRPS	SPR500	Pin & Pipe Safeties	6.5	7	€ 89.00
14	SPRSA	SPR500 / SPR1000	Spotter Arms	17	18	€ 189.00
15	SPRSF	SPR1000	Premium Safeties	14.8	16.2	€ 215.00
16	SPRSP	SPR500 / SPR1000 / GPR400	Spotter Stand	20		€ 215.00
17	SPRSS	SPR1000	Power Rack Strap Safeties	9.7	10.4	€ 279.00
18	SPRST	SPR500 / SPR1000	Storage Tray	14.7	16.1	€ 199.00
19	SPRTB	SPR500 / SPR1000	Dual T-Bar Row	3.8	4	€ 95.00
20	SR-BHV	SPR500 / SPR1000	Vertical Bar Storage	4.2	5.4	€ 95.00
21	SR-DIP	SPR500	Dip Station			€ 299.00
22	SR-MGC	SPR1000	Multi-Grip Chin Up (2 in box)	12.8	14.5	€ 269.00
23	SR-REB	SPR1000	Rebounder	24.8	29.9	€ 760.00
24	SR-SBH	SPR500 / SPR1000	Stability Ball Holder	6.4	8.2	€ 209.00
25	SR-STEP	SPR500 / SPR1000	Step (Plyo) Attachment	16.4	18.6	€ 369.00
26	SR-UL	SPR500 / SPR1000	U-Link Attachment (for ropes/tubes)	4.5	5.4	€ 115.00
27	SR-WPH	SPR1000	Weight plate Horns	2.9	4.1	€ 55.00

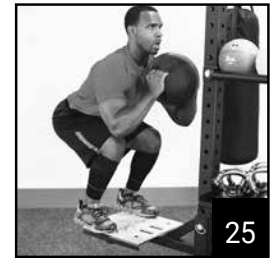
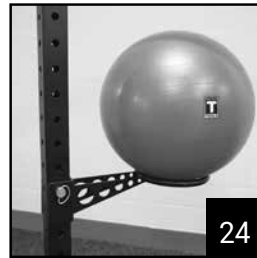
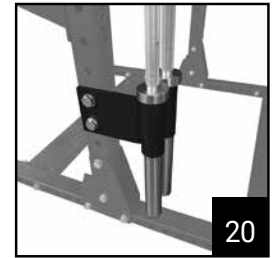
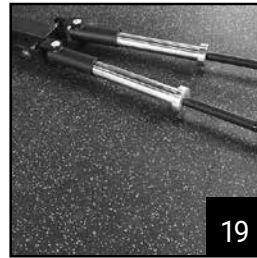
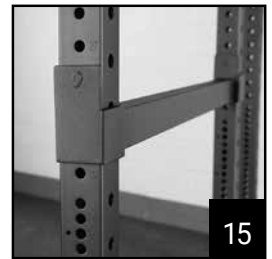
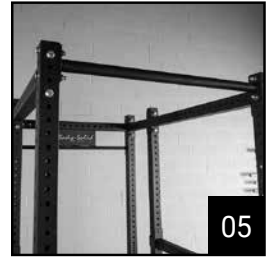
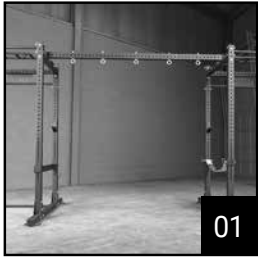



	POWERLINE 2 TIER DUMBBELL RACK	SPECIFICATIONS
	ITEM#: PDR282X Weight: 14.5 kg Dimensions: L 35.5 x W 82.5 x H 57.5 cm Warranty: Frame: 10 years - Parts: 2 years	<ul style="list-style-type: none"> • Can be placed against any wall or centered in a room • Heavy gauge steel with all-4-side welded construction • Holds one (1) pair each of 2-13.6 kg hex dumbbells
PDR282X	Powerline 2 Tier Dumbbell Rack	€ 135.00

	BEST FITNESS DUMBBELL RACK	SPECIFICATIONS
	ITEM#: BFDR10 Weight: 21 kg Dimensions: L 106.7 x W 58.4 x H 76.2 cm Warranty: Frame: 10 years - Parts: 2 years	<ul style="list-style-type: none"> • Keep workout areas clean, organized and safe • Three-tier dumbbell rack • Holds 10 pairs of hex dumbbells (2-22 kg) • Powder-coat finish
BFDR10	Body-Solid Dumbbell Rack	€ 169.00



	3 TIER HORIZONTAL DUMBBELL RACK	SPECIFICATIONS
	ITEM#: GDR363 Weight: 20 kg Dimensions: L 50.3 x W 102.2 x H 76.2 cm Warranty: In-Home Lifetime (P. 119)	<ul style="list-style-type: none"> • Space efficient design • Will hold a set of 2-22 kg hex dumbbells • Heavy-duty 12 gauge steel construction
GDR363	Body-Solid 3 Tier Horizontal Dumbbell Rack	€ 189.00



	VINYL DUMBBELL RACK	SPECIFICATIONS
	ITEM#: GDR10 Weight: 1.7 kg Dimensions: L 38 x W 22.8 x H 44.5 cm Warranty: In-Home Lifetime (P. 119)	<ul style="list-style-type: none"> • Holds 3 pairs of vinyl or neoprene dumbbells • Compact storage
GDR10	Body-Solid Vinyl Dumbbell Rack	€ 79.00



	12 PAIR VERTICAL DUMBBELL RACK	SPECIFICATIONS
	ITEM#: GDR24 Weight: 15.8 kg Dimensions: L 62.5 x W 80 x H 131 cm Warranty: In-Home Lifetime / Light Commercial (P. 119)	 <ul style="list-style-type: none"> • Space efficient • Holds 12 pairs of vinyl or neoprene dumbbells • Fits 0.5 to 17 kg vinyl or neoprene dumbbells • Solid steel construction
GDR24	Body-Solid 12 Pair Vinyl, Neoprene Dumbbell Rack	€ 179.00



	VINYL / NEOPRENE DUMBBELL RACK	SPECIFICATIONS
	ITEM#: GDR34 Weight: 23 kg Dimensions: L 85.7 x W 36.4x H 61.6 cm Warranty: In-Home Lifetime (P. 119)	<ul style="list-style-type: none"> • Holds one pair of 0.5-6.8 kg vinyl or neoprene dumbbells
GDR34	Body-Solid Vinyl / Neoprene Dumbbell Rack	€ 79.00



	6 PAIR VERTICAL DUMBBELL RACK	SPECIFICATIONS
	ITEM#: GDR44 Weight: 14 kg Dimensions: L 63.6 x W 58 x H 113.3 cm Warranty: In-Home Lifetime (P. 119)	<ul style="list-style-type: none"> • 2-Tier vertical dumbbell rack • Holds 6 Pair of Hex dumbbells • Each level is off-set, to allow unrestricted access • Heavy gauge steel construction
GDR44	Body-Solid 6 Pair vertical Dumbbell Rack	€ 175.00



	3 TIER DUMBBELL RACK		SPECIFICATIONS	
	ITEM#: GDR48	Weight: 28 kg		<ul style="list-style-type: none"> • Holds one pair of 2.2-30 kg hex dumbbells • Offset tiers for easy loading • 5 cm tray space pier tier • Durable powder-coat paint finish
Dimensions: L 122 x W 57.6 x H 77 cm	Warranty: In-Home Lifetime / Light Commercial (P. 119)			
GDR48	Body-Solid 3 Tier Dumbbell Rack		€ 279.00	



	2 TIER HORIZONTAL DUMBBELL RACK		SPECIFICATIONS	
	ITEM#: GDR60	Weight: 36.7 kg		<ul style="list-style-type: none"> • 5 x 7.6 cm steel mainframe • Each level is slanted, to allow unrestricted access • 2-tier design holds 2-22 kg dumbbell set
Dimensions: L 157.5 x W 58.4 x H 81.2 cm	Warranty: Full Commercial (P. 119)			
GDR60	Body-Solid 2 Tier Horizontal Dumbbell Rack		€ 325.00	

	OPTIONAL THIRD TIER FOR GDR60		SPECIFICATIONS	
	ITEM#: GDRT6	Weight: 11 kg		<ul style="list-style-type: none"> • Allows storage of up to 30 kg hex dumbbell pairs. Featuring heavy-duty construction for maximum strength and stability. Exclusive slant back design makes storage and retrieval a breeze.
Dimensions: L 146 x W 32 x H 8 cm	Warranty: Full Commercial (P. 119)			
GDRT6	Body-Solid Optional Third Tier For GDR60		€ 110.00	

	KETTLEBELL SHELF FOR GDR60		SPECIFICATIONS	
	ITEM#: GKRT6	Weight: 15		<ul style="list-style-type: none"> • Body-Solid's GKRT6 adds an optional third-tier kettlebell storage rack to the existing GDR60 dumbbell rack. The GKRT6 is designed to hold 2-22 kg kettlebell set and will help keep your workout space clean, organized and safe.
Dimensions: L 148 x W 34 x H 9.5 cm	Warranty: Full Commercial (P. 119)			
GKRT6	Body-Solid Kettlebell Shelf for GDR60		€ 155.00	



	MEDICINE BALL SHELF FOR GDR60		SPECIFICATIONS	
	ITEM#: GMRT6	Weight: 5.5 kg		<ul style="list-style-type: none"> • Body-Solid's GMRT6 is an optional third-tier medicine ball storage rack for the GDR60 dumbbell rack. The GMRT6 is the perfect storage solution for medicine balls, dual-grip medicine balls, slam balls and more.
Dimensions: L 148 x W 27 x H 6.5 cm	Warranty: Full Commercial (P. 119)			
GMRT6	Body-Solid Medicine Ball Shelf for GDR60		€ 110.00	

	10 PAIR VERTICAL DUMBBELL RACK		SPECIFICATIONS	
	ITEM#: GDR80	Weight: 26.3 kg		<ul style="list-style-type: none"> • Vertical storage for 10 pairs of Hex Dumbbells • Keep workout space clean, organized and safe • Perfect fit for a 2-22.5 kg cast or rubber Hex Dumbbell set • Top tray can be used for medicine ball storage
Dimensions: L 62.3 x W 55.9 x H 103.7 cm	Warranty: In-Home Lifetime / Light Commercial (P. 119)			
GDR80	Body-Solid 10 Pair vertical Dumbbell Rack		€ 375.00	

	SADDLE RACK - 10 PAIRS		SPECIFICATIONS	
	ITEM#: SADRACK	Weight: 55 kg		<ul style="list-style-type: none"> • Designed for Pro-Style & round head dumbbells • Commercial quality • Holds 10 pairs of dumbbells • Protective rubber encased dumbbell saddles • Weight Capacity: 900 kg • Rubber feet to protect floors
Dimensions: L 244 x W 66 x H 81 cm	Warranty: 6 Months			
SADRACK	Bodytrading Saddle Rack 10 Pairs		€ 445.00	

	VERTICAL DUMBBELL RACK 10 PAIRS	SPECIFICATIONS
	ITEM#: DUMRACK Weight: 18 kg Dimensions: N/A Warranty: In-Home Lifetime (P. 119)	<ul style="list-style-type: none"> Vertical storage for 10 pairs of Hex Dumbbells Keep workout space clean, organized and safe Perfect fit for a 2-22.5 kg cast or rubber Hex Dumbbell set Top tray can be used for medicine ball storage
DUMRACK	10 Pair Vertical Dumbbell Rack	€ 250.00



	RACK FOR 6 KETTLEBELLS	SPECIFICATIONS
	ITEM#: GDKR50 Weight: 8.5 kg Dimensions: L 48.2 x W 50.8 x H 53.3 cm Warranty: In-Home Lifetime (P. 119)	<ul style="list-style-type: none"> Stores 6 total Kettlebells, any size 3 offset tiers for easy access Modern Design Compact, Stable and Affordable
GDKR50	Body-Solid Kettlebell Rack	€ 145.00



	DUMBBELL / KETTLEBELL RACK		SPECIFICATIONS
	ITEM#: GDKR100 Weight: 36 kg Dimensions: L 113 x W 58.4 x H 83.8 cm Warranty: In-Home Lifetime / Light Commercial (P. 119)		<ul style="list-style-type: none"> Holds dumbbells, kettle bells, or both Reversible tiers provide versatility Kettlebell side can hold accessories as well Dumbbell side can be angled for easy access
GDKR100	Body-Solid 2 Tier Dumbbell / Kettlebell Rack		€ 315.00



	OLYMPIC PLATE TREE	SPECIFICATIONS
	ITEM#: OWT24 Weight: 10.7 kg Dimensions: L 68.5 x W 40.6 x H 61 cm - Ø 50 mm Warranty: In-Home Lifetime (P. 119)	<ul style="list-style-type: none"> Design directs the weight load to the center 454 kg of weight capacity Six storage posts
OWT24	Body-Solid Olympic Plate Tree	€ 95.00



	STANDARD PLATE TREE	SPECIFICATIONS
	ITEM#: SWT14 Weight: 7.6 kg Dimensions: L 40.6 x W 68.5 x H 61 cm - Ø 25 mm Warranty: In-Home Lifetime (P. 119)	<ul style="list-style-type: none"> Design directs the weight load to the center 454 kg of weight capacity Six storage posts
SWT14	SWT14 Body-Solid Standard Plate Tree	€ 85.00



	BEST FITNESS WEIGHT TREE	SPECIFICATIONS
	ITEM#: BFWT10 Weight: 18.2 kg Dimensions: L 61 x W 63.5 x H 134.6 cm Warranty: Frame: 10 years - Parts: 2 years	<ul style="list-style-type: none"> Six 23 cm weight horns for storage of bumper and Olympic plates Two Olympic bar holders Weight capacity: 180 kg
BFWT10	Best Fitness Weight Tree	€ 159.00



	OLYMPIC PLATE TREE & BAR HOLDER		SPECIFICATIONS
	ITEM#: GOWT Weight: 14 kg Dimensions: L 51 x W 58.4 x H 101.6 cm - Ø 50 mm Warranty: In-Home Lifetime / Light Commercial (P. 119)		<ul style="list-style-type: none"> Holds up to 454 kg of weight 6 storage posts of 5 x 20,3 cm for Olympic plates 2 vertical storage posts for bars
GOWT	Body-Body-Solid Olympic Plate Tree and Bar Holder		€ 135.00



	STANDARD PLATE TREE & BAR HOLDER		SPECIFICATIONS
	ITEM#: GSWT		<ul style="list-style-type: none"> • 454 kg of weight capacity • 6 storage posts of 2,5 x 20 cm for standard plates • Holds two vertical standard bars • High tensile strength steel 5 x 5 cm
Weight: 11 kg			
Dimensions: L 50.8 x W 58.4 x H 101.6 cm - Ø 25 mm			
Warranty: In-Home Lifetime / Light Commercial (P. 119)			
GSWT	Body-Solid Standard Plate Tree and Bar Holder		€ 125.00



	OLYMPIC WEIGHT TREE & BAR HOLDER		SPECIFICATIONS
	ITEM#: WT46		<ul style="list-style-type: none"> • 5 x 7.6 cm and 7.6 x 7.6 cm steel construction • Six triple chrome plated Olympic weight posts • Super-tough ABS plastic ball-end storage post caps • 454 kg of weight capacity
Weight: 15.3 kg			
Dimensions: L 55 x W 50 x L 102 cm - Ø 50 mm			
Warranty: In-Home Lifetime / Light Commercial (P. 119)			
WT46	Body-Solid Olympic Weight Tree and Bar Holder		€ 179.00



	OLYMPIC PLATE TREE & BAR HOLDER		SPECIFICATIONS
	ITEM#: GWT56		<ul style="list-style-type: none"> • Chrome plated weight posts, 6 x 22.8 cm • 2 x Olympic bar holders • Spacing permits any size bumper or Olympic plate on any post • No plastic, welded metal foot caps and end caps • Weight capacity: 450 kg
Weight: 23 kg			
Dimensions: L 75 x W 75 x H 135 cm - Ø 50 mm			
Warranty: In-Home Lifetime / Light Commercial (P. 119)			
GWT56	Body-Solid Olympic Plate Tree & Bar Holder		€ 259.00



	WEIGHT TREE		SPECIFICATIONS
	ITEM#: GWT66		<ul style="list-style-type: none"> • Chrome plated weight posts, 8 x 22.8 cm • Spacing permits any size bumper or Olympic plate on any post • No plastic, welded metal foot caps and end caps • Weight capacity: 540 kg
Weight: 26.6 kg			
Dimensions: L 65 x W 108 x H 84.3 cm			
Warranty: In-Home Lifetime / Full Commercial (P. 119)			
GWT66	Body-Solid Weight Tree		€ 289.00

	WEIGHT TREE		SPECIFICATIONS
	ITEM#: GWT76		<ul style="list-style-type: none"> • Customize to fit 8 bumper plates on 8 weight horns or 10 Olympic plates on 10 weight horns • Each weight horn features 21 cm capacity • All-welded caps • Accessibility against a wall
Weight: 51.5 kg			
Dimensions: L 98.5 x W 91.6 x H 166 cm			
Warranty: In-Home Lifetime / Full Commercial (P. 119)			
GWT76	Body-Solid Weight Tree		€ 525.00



	BUMPER PLATE RACK		SPECIFICATIONS
	ITEM#: GBPR10		<ul style="list-style-type: none"> • 10 cm gaps in each of the 8 plate slots • Warranted for any commercial environment • Durable charcoal powder coat finish • Fully welded steel construction
Weight: 10 kg			
Dimensions: L 109 x W 32.8 x H 23 cm			
Warranty: In-Home Lifetime / Light Commercial (P. 119)			
GBPR10	Body-Solid Commercial Bumper Plate Rack		€ 295.00



	FITNESS BAR RACK		SPECIFICATIONS
	ITEM#: GFR500		<ul style="list-style-type: none"> • Compact, stable and affordable • Vertical storage for up to 30 Fitness Bars • Stores Fitness Bars from 2 kg up to 16 kg
Weight: 17 kg			
Dimensions: L 71.9 x W 61.2 x H 109 cm			
Warranty: In-Home Lifetime / Light Commercial (P. 119)			
GFR500	Body-Solid Fitness Bar Rack		€ 239.00



	VINYL DUMBBELL RACK		SPECIFICATIONS
	ITEM#: GDR500 Weight: 39.5 kg Dimensions: L 111.7 x W 67.3 x H 116.8 cm Warranty: Full Commercial (P. 119)		<ul style="list-style-type: none"> Stores vinyl or neoprene Dumbbells from 0.5 up 7 kg Capable of storing over 50 pairs on one rack Heavy, industrial caster wheels for easy transport
GDR500	Body-Solid Vinyl Dumbbell Rack		€ 495.00



	MEDICINE BALL RACK		SPECIFICATIONS
	ITEM#: GMR10 Weight: 13 kg Dimensions: L 57 x W 49.5 x H 158 cm Warranty: In-Home Lifetime / Light Commercial (P. 119)		<ul style="list-style-type: none"> Vertical storage for up to 6 Medicine Balls or 6 Dual Grip Medicine Balls 6 storage posts; for medicine balls from 900g to 7,2 kg or dualgrip balls from 2,7 kg to 9 kg Curved oval upright allows for easy access to every tier
GMR10	Body-Solid Medicine Ball Rack		€ 195.00



	MEDICINE BALL RACK		SPECIFICATIONS
	ITEM#: GMR5 Weight: 4.6 kg Dimensions: L 54.7 x W 54.7 x H 83 cm Warranty: In-Home Lifetime (P. 119)		<ul style="list-style-type: none"> The rack fits medicine balls from 2lbs to 6 lbs For medicine balls from 900 g to 7,2 kg or dualgrip balls from 2,7 kg to 9 kg The two rings are adjustable 360 ° for perfect placement in any room. Customizable, Stable and Affordable
GMR5	Body-Solid Medicine Ball Rack		€ 90.00



	STABILITY BALL RACK		SPECIFICATIONS
	ITEM#: GSR10 Weight: 13.7 kg Dimensions: L 80.5 x W 91.2 x H 186.5 cm Warranty: In-Home Lifetime / Light Commercial (P. 119)		<ul style="list-style-type: none"> The compact design fits into any corner Allows easy access for all 3 stability balls Made from heavy gauge steel Customizable, Stable and Affordable
GSR10	Body-Solid Stability Ball Rack		€ 195.00



	PRO CLUBLINE WEIGHT TREE BAR HOLDER		SPECIFICATIONS
	ITEM#: SWT1000 Weight: 57 kg Dimensions: L 147 x W 147 x H 133.7 cm - Ø 50 mm Warranty: Full Commercial (P. 119)		<ul style="list-style-type: none"> 12 chrome weight posts 4 Integrated Olympic bar holders 2 Integrated Olympic collar holders Perfect for bumper plates Oval 11 gauge steel frame
SWT1000	Pro Clubline Olympic Weight Tree Bar Holder		Weight plates not included! € 895.00



	5 BAR - OLYMPIC BAR HOLDER		SPECIFICATIONS
	ITEM#: GOBH5 Weight: 10 kg Dimensions: L 30.4 x W 30.4 x H 22.8 cm Warranty: In-Home Lifetime / Light Commercial (P. 119)		<ul style="list-style-type: none"> Barholder for 5 Olympic bars Also curl bars, triceps bars, trap bars Designed for speed, safety, and convenience Satin black powder coat finish
GOBH5	Body-Solid 5 Bar, Olympic Bar Holder		€ 155.00



	ACCESSORY STAND		SPECIFICATIONS
	ITEM#: VDRA30 Weight: 29 kg Dimensions: L 47 x W 44.4 x H 102.2 cm Warranty: In-Home Lifetime / Light Commercial (P. 119)		<ul style="list-style-type: none"> Stores and organizes multiple accessory bars, ropes, straps and even dumbbells Can hold 36 items Efficient and compact design
VDRA30	Body-Solid Accessory Stand		Accessories not included. € 265.00



	ROLLING STORAGE CART		SPECIFICATIONS	
	ITEM#: GYR500		<ul style="list-style-type: none"> High-quality storage solution for yoga mats and foam rollers Ideal for home, small studio or commercial use Made from heavy gauge steel Featuring four lockable wheels 	
Weight: 17 kg				
Dimensions: L 81 x W 51 x H 92.5 cm				
Warranty: In-Home Lifetime / Light Commercial (P. 119)				
GYR500	Body-Solid Mat/Roller Storage		Accessories not included.	€ 225.00



	ACCESSORY RACK		SPECIFICATIONS	
	ITEM#: GAR100		<ul style="list-style-type: none"> Holds up to 6 medicine balls, slam balls Holds three stability balls Holds four foam rollers or yoga mats Four prongs for tube and band storage Included transport wheels for convenient mobility 	
Weight: 32 kg				
Dimensions: L 81.3 x W 91.4 x H 188 cm				
Warranty: In-Home Lifetime / Light Commercial (P. 119)				
GAR100	Body-Solid Accessory Rack			€ 435.00







	MULTI ACCESSORY RACK		SPECIFICATIONS	
	ITEM#: GAR250		<ul style="list-style-type: none"> Multi-use storage tower 3 shelves for medicine balls, wall & slam balls 2 depth trays for kettlebells and dumbbells Three stability ball holders Pegs for mats, cable attachments and accessories Fully-customizable 	
Weight: 70.76 kg				
Dimensions: L 81.3 x W 200.6 x H 221 cm				
Warranty: In-Home Lifetime / Light Commercial (P. 119)				
GAR250	Body-Solid Multi Accessory Rack			€ 895.00



	HORIZONTAL BAR RACK		SPECIFICATIONS	
	ITEM#: SBS100		<ul style="list-style-type: none"> Easy access storage for up to 10 Olympic bars Composite lining protects bar finish Fits 180 and 210 cm Olympic bars 	
Weight: 38.56 kg				
Dimensions: L 61 x W 114.3 x H 182.8 cm				
Warranty: In-Home Lifetime / Light Commercial (P. 119)				
SBS100	Body-Solid Horizontal Bar Rack			€ 450.00

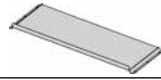
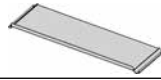
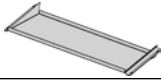

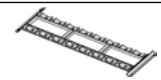
	HORIZONTAL BAR RACK		SPECIFICATIONS	
	ITEM#: SBBR100		<ul style="list-style-type: none"> Easy access storage for up to 10 Olympic bars Composite lining protects bar finish Fits 180 and 210 cm Olympic bars 	
Weight: 63.2 kg				
Dimensions: L 102 x W 94.4 x H 156.4 cm				
Warranty: Full Commercial (P. 119)				
SBBR100	Body-Solid Horizontal Bar Rack			€ 695.00



	STABILITY BALL RACK		SPECIFICATIONS	
	ITEM#: SSBR100		<ul style="list-style-type: none"> Holds up to 8 stability balls, 45 to 75 cm in size Keeps stability balls clean and organized Rounded tubing protects your stability balls Locking caster wheels for easy mobility 	
Weight: 15.42 kg				
Dimensions: L 44 x W 139.2 x H 226 cm				
Warranty: In-Home Lifetime / Light Commercial (P. 119)				
SSBR100	Body-Solid Stability Ball rack			€ 319.00



	STABILITY BALL RACK		SPECIFICATIONS	
	ITEM#: SSBR200		<ul style="list-style-type: none"> Holds up to 12 stability balls, 45 to 75 cm in size Keeps stability balls clean and organized Rounded tubing protects your stability balls Locking caster wheels for easy mobility 	
Weight: 17.7 kg				
Dimensions: L 44 x W 273 x H 158.7 cm				
Warranty: In-Home Lifetime / Light Commercial (P. 119)				
SSBR200	Body-Solid Stability Ball rack			€ 425.00



PRO CLUBLINE MODULAR STORAGE SYSTEM MODELS				
 <p>Weights & Balls NOT included</p>	ITEM#: SDKR			
	Warranty: Full Commercial (P. 119)			
		SDKRDBS	Pro Clubline Small Dumbbell Shelf	€ 235.00
		SDKRDBL	Pro Clubline Large Dumbbell Shelf	€ 245.00
		SDKRKB	Pro Clubline Kettlebell Shelf	€ 200.00
		SDKRMB	Pro Clubline Medicine Ball Shelf	€ 125.00
		SDKRSD6	Pro Clubline Saddle Dumbbell Rack 6 spots	€ 210.00
		SDKRSD8	Pro Clubline Saddle Dumbbell Rack 8 spots	€ 220.00
		SDKRUP2	Pro Clubline Uprights 2 Tiers	€ 225.00
	SDKRUP3	Pro Clubline Uprights 3 Tiers	€ 315.00	



PRO CLUBLINE DUMBBELL RACK		SPECIFICATIONS	
	ITEM#: SDKR500DB		SDKR500DB Includes: • 2-SDKRUP2 2-Tier Uprights • 2-SDKRDBS Small Dumbbell Shelves
	Weight: N/A		
	Dimensions: L 177.5 x W 75 x H 68.8 cm		
	Warranty: Full Commercial (P. 119)		
SDKR500DB	Pro Clubline Dumbbell Rack	€ 920.00	



PRO CLUBLINE DUMBBELL RACK		SPECIFICATIONS	
	ITEM#: SDKR1000DB		SDKR1000DB Includes: • 2-SDKRUP3 3-TIER UPRIGHTS • 3-SDKRDBS Small Dumbbell Shelves
	Weight: N/A		
	Dimensions: L 177.5 x W 82.6 x H 109.5 cm		
	Warranty: Full Commercial (P. 119)		
SDKR1000DB	Pro Clubline Dumbbell Rack	€ 1335.00	



PRO CLUBLINE SADDLE DUMBBELL RACK		SPECIFICATIONS	
	ITEM#: SDKR500SD		SDKR500SD Includes: • 2-SDKRUP2 2-Tier Uprights • 1-SDKRSD6 Dumbbell Saddle (6 spots) • 1-SDKRSD8 Dumbbell Saddle (8 spots)
	Weight: 64.41 kg		
	Dimensions: L 177.5 x W 75 x H 68.8 cm		
	Warranty: Full Commercial (P. 119)		
SDKR500SD	Pro Clubline Saddle Dumbbell Rack	€ 875.00	

PRO CLUBLINE SADDLE DUMBBELL RACK		SPECIFICATIONS	
	ITEM#: SDKR1000SD		SDKR1000SD Includes: • 2-SDKRUP3 3-Tier Uprights • 2-SDKRSD6 Dumbbell Saddle (6 spots) • 1-SDKRSD8 Dumbbell Saddle (8 spots)
	Weight: 99.8 kg		
	Dimensions: L 177.5 x W 82.6 x H 109.5 cm		
	Warranty: Full Commercial (P. 119)		
SDKR1000SD	Pro Clubline Saddle Dumbbell Rack	€ 1270.00	

	PRO CLUBLINE MEDICINE BALL RACK		SPECIFICATIONS
	ITEM#: SDKR500MB		SDKR500MB Includes: • 2-SDKRUP2 2-Tier Uprights • 2-SDKRMB Medicine Ball Shelves
Weight: 64.4 kg	Dimensions: L 177.5 x W 75 x H 68.8 cm		
Warranty: Full Commercial (P. 119)			
SDKR500MB	Pro Clubline Medicine Ball Rack		€ 680.00

	PRO CLUBLINE MEDICINE BALL RACK		SPECIFICATIONS
	ITEM#: SDKR1000MB		SDKR1000MB includes: • 2-SDKRUP2 3-Tier Uprights • 3-SDKRMB Medicine Ball Shelves
Weight: 99.8 kg	Dimensions: L 177.5 x W 82.6 x H 109.5 cm		
Warranty: Full Commercial (P. 119)			
SDKR1000MB	Pro Clubline Medicine Ball Rack		€ 975.00

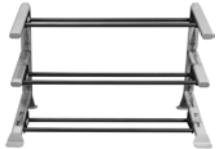
	PRO CLUBLINE KETTLEBELL RACK		SPECIFICATIONS
	ITEM#: SDKR500KB		SDKR500KB includes: • 2-SDKRUP2 2-Tier Uprights • 2-SDKRKB Kettlebell Shelves
Weight: 64.4 kg	Dimensions: L 177.5 x W 82.6 x H 68.8 cm		
Warranty: Full Commercial (P. 119)			
SDKR500KB	Pro Clubline Kettlebell Rack		€ 850.00

	PRO CLUBLINE KETTLEBELL RACK		SPECIFICATIONS
	ITEM#: SDKR1000KB		SDKR1000KB includes: • 2-SDKRUP2 2-Tier Uprights • 2-SDKRKB Kettlebell Shelves
Weight: 99.8 kg	Dimensions: L 177.5 x W 82.6 x H 109.5 cm		
Warranty: Full Commercial (P. 119)			
SDKR1000KB	Pro Clubline Kettlebell Rack		€ 1230.00

	GUT BLASTER SLINGS (PAIR)	SPECIFICATIONS
	ITEM#: AAB2 Weight: 1.1 kg/pair Dimensions: L 5 x W 19 x H 53 cm Warranty: 6 Months	<ul style="list-style-type: none"> • Thick, comfortable, contoured support pads • Solid steel Carabineers • 21.5 cm wide, 2.5 cm thick pads
AAB2	Body-Solid Gut Blaster Slings	€ 99.00

	AB WHEEL	SPECIFICATIONS
	ITEM#: BSTAB1 Weight: 0.45 kg Dimensions: L 25.4 x W 20.3 x H 2.3 cm Warranty: 6 Months	<ul style="list-style-type: none"> • Targets your abs, shoulders, arms and back • Dual wheels for greater stability • Comfortable, easy grip handles
BSTAB1	Body-Solid Tools Ab Wheel	€ 25.00

	PUSH UP BARS (PAIR)	SPECIFICATIONS
	ITEM#: PUB2 Weight: N/A Dimensions: N/A Warranty: 6 Months	<ul style="list-style-type: none"> • Designed to alleviate stress on your wrists and hands • Simple to use, strong, sturdy and durable
PUB2	Body-Solid Push Up Bars	€ 25.00

	PREMIUM PUSH UP BARS (PAIR)	SPECIFICATIONS
	ITEM#: PUB5 Weight: N/A Dimensions: L 16.5 x W 15.2 x H 21.6 cm Warranty: 6 Months	<ul style="list-style-type: none"> • Increase range of motion for deeper push-ups • Comfortable anti-slip grips • Designed to alleviate stress on your wrists and hands
PUB5	Body-Solid Premium Push Up Bars	€ 79.00

	FULL FOAM ROLLER 90 CM	SPECIFICATIONS
	ITEM#: BSTFR36F Weight: 1.2 kg Dimensions: L 91.4 x W 15.2 x H 15.2 cm Warranty: 6 Months	<ul style="list-style-type: none"> • Latex free Full Foam Roller • Each is 92 cm in length • Full round 15 cm in diameter • Color: blue
BSTFR36F	Body-Solid Tools Full Foam Roller	€ 39.00

	HALF FOAM ROLLER 90 CM	SPECIFICATIONS
	ITEM#: BSTFR36H Weight: 0.6 kg Dimensions: L 91.4 x W 15.2 x H 7.6 cm Warranty: 6 Months	<ul style="list-style-type: none"> • Latex free Full Foam Roller • Each is 92 cm in length • Half round 15 cm in diameter
BSTFR36H	Body-Solid Tools Half Foam Roller	€ 39.00

	PREMIUM FOAM ROLLER 45 CM	SPECIFICATIONS
	ITEM#: BSTFRP18 Weight: 0.9 kg Dimensions: L 46 x W 14 x H 14 cm Warranty: 6 Months	<ul style="list-style-type: none"> • Premium EVA Foam structure for ultimate support and durability • Perfect for balance exercises, stability exercises, and strength training • Foam roller is 15 cm in diameter • Color: black
BSTFRP18	Body-Solid Tools Premium Full Foam Roller, EVA, High Density	€ 39.00

	PREMIUM FOAM ROLLER 90 CM		SPECIFICATIONS
	ITEM#: BSTFRP36 Weight: 1.4 kg Dimensions: L 91 x W 15 x H 15 cm Warranty: 6 Months		<ul style="list-style-type: none"> Premium EVA Foam structure for ultimate support and durability, 15 cm in diameter Increases blood flow, stretches muscles and improves range of motion Firm density designed to withstand constant use without breakdown Color: black
BSTFRP36	Body-Solid Tools Premium Full Foam Roller, EVA, High Density		€ 65.00

	EXERCISE RINGS, PAIR WITH STRAP		SPECIFICATIONS
	ITEM#: BSTRINGS Weight: 2.7 kg (set) Dimensions: L 43 x W 30 x H 30 cm Warranty: 6 Months		<ul style="list-style-type: none"> Solid steel construction 2.5 cm diameter Adjustable nylon straps 4 kg (entire set)
BSTRINGS	Body-Solid Tools Exercise Rings, Pair With Strap		€ 89.00

	INVERSION BOOTS		SPECIFICATIONS
	ITEM#: GIB2 Weight: 2.6 kg Dimensions: L 17.8 x W 21.6 x H 17.8 cm Warranty: 6 Months		<ul style="list-style-type: none"> Thick, comfortable, contoured support pads Heavy duty single-action locking mechanism Built-in safety lever Extra pads allow easy adjustment for all size users
GIB2	Body-Solid Inversion Boots		€ 90.00

	SPEED JUMP ROPE		SPECIFICATIONS
	ITEM#: BSTJR1 Weight: 0.1 kg Dimensions: L 333 x W 2.5 x H 2.5 cm Warranty: 6 Months		<ul style="list-style-type: none"> Improve strength, agility, coordination & endurance Adjustable to fit any user Durable and compact
BSTJR1	Body-Solid Tools Speed Jump Rope		€ 14.00

	PREMIUM CABLE SPEED ROPE		SPECIFICATIONS
	ITEM#: BSTSR1 Weight: N/A Dimensions: L 333 x W 2.5 x H 2.5 cm Warranty: 6 Months		<ul style="list-style-type: none"> Adjustable up to 333 cm Sealed bearing pivot Ergonomic handle
BSTSR1	Body-Solid Tools Premium Cable Speed Rope		€ 22.00

	PREMIUM SPEED ROPE		SPECIFICATIONS
	ITEM#: BSTSR10 Weight: 0.7 kg Dimensions: L 333 x W 2.5 x H 2.5 cm Warranty: 6 Months		<ul style="list-style-type: none"> 305 cm adjustable length 0.5 cm PVC-coated speed cable Contoured non-slip aluminum handles 0.7 kg adjustable handle weights Sealed ball-bearing swivels
BSTSR10	Body-Solid Tools Premium Speed Rope		€ 35.00

	YOGA BLOCK		SPECIFICATIONS
	ITEM#: BSTYB10 Weight: 0.2 kg Dimensions: L 15 x W 10 x H 22.5 cm Warranty: 6 Months		<ul style="list-style-type: none"> Lightweight, high-density and sturdy Provides extra stability, support and flexibility during Yoga poses Supports back, head and hips for longer, more comfortable and safer positions Beveled edges provide soft, stable grip Deepens your stretches and poses
BSTYB10	Body-Solid Tools Yoga Block		€ 10.00

	TIME CLOCK	SPECIFICATIONS
	ITEM#: STT45 Weight: 0.46 kg Dimensions: L 36.8 x W 36.8 x H 3.1 cm Warranty: 6 Months	<ul style="list-style-type: none"> Made of high-impact polymer resin Accurate quartz movement that requires one AA battery
STT45	Body-Solid Tools Strength Training Time Clock	€ 45.00

	DOOR CHINNING BAR	SPECIFICATIONS
	ITEM#: PUB34 Weight: 4 kg Dimensions: L 96.5 x W 40.6 x H 17.8 cm (adjustable 73.5 to 96.5 cm) Warranty: 6 Months	<ul style="list-style-type: none"> Constructed of heavy gauge reinforced steel Quickly and easily mounts to doorway frame Extends above doorway frame for head clearance when doing pull-ups Convenient lift-out design for easy storage
PUB34	Body-Solid Chin Up Bar	€ 119.00

	NYLON HEAD HARNESS	SPECIFICATIONS
	ITEM#: MA307 Weight: 0.7 kg Dimensions: L 24 x W 17.8 x H 6 cm Warranty: 6 Months	<ul style="list-style-type: none"> Padded with high density neoprene Condition the neck and upper back muscles Extra-heavy D rings and steel chain
MA307	Body-Solid Nylon Head Harness	€ 45.00

	LEATHER DIPPING BELT	SPECIFICATIONS
	ITEM#: MA330 Weight: 1 kg Dimensions: L 112 x W 18 x H 2.5 cm Warranty: 6 Months	<ul style="list-style-type: none"> Constructed from top-grain leather Extended back pad for comfort and stability Increases the effectiveness of dips, chins and lunges
MA330	Body-Solid Leather Dipping Belt	€ 59.00

	ANKLE WEIGHT 4.5 KG (PAIR)	SPECIFICATIONS
	ITEM#: BSTAW10 Weight: 4.5 kg per pair Dimensions: L 36 x W 18 x H 1.9 cm Warranty: 6 Months	<ul style="list-style-type: none"> Two Ankle Weights, 2.25 kg each Comfortable and Adjustable up to 22.5 kg
BSTAW10	Body-Solid Ankle Weights, Pair	€ 109.00

	ANKLE WEIGHT 9 KG (PAIR)	SPECIFICATIONS
	ITEM#: BSTAW20 Weight: 9.2 kg per pair Dimensions: L 36 x W 18 x H 1.92 cm Warranty: 6 Months	<ul style="list-style-type: none"> Two Ankle Weights, 4.5 kg each Comfortable and Adjustable up to 24.5 kg
BSTAW20	Body-Solid Ankle Weights, Pair	€ 139.00

	WEIGHTED VEST 9 KG	SPECIFICATIONS
	ITEM#: BSTWV20 Weight: 10 kg Dimensions: L 51 x W 34.5 x H 11.5 cm Warranty: 6 Months	<ul style="list-style-type: none"> Premium, durable stitching Adjustable up to 9 kg Fast and easy weight customization Flexible sandbag weights conform to body Two Velcro straps ensure perfect fit
BSTWV20	Body-Solid Weighted Vest 10 kg	€ 129.00

	WEIGHTED VEST 18 KG	SPECIFICATIONS
	<p>ITEM#: BSTWV40</p> <p>Weight: 20 kg</p> <p>Dimensions: L 51 x W 34.5 x H 11.5 cm</p> <p>Warranty: 6 Months</p>	<ul style="list-style-type: none"> Premium, durable stitching Adjustable up to 18 kg Fast and easy weight customization Flexible sandbag weights conform to body Two Velcro straps ensure perfect fit
BSTWV40	Body-Solid Weighted Vest 20 kg	€ 159.00

	BICEPS BOMBER	SPECIFICATIONS
	<p>ITEM#: BB23</p> <p>Weight: 0.7 kg</p> <p>Dimensions: L 58 x W 10 x H 10 cm</p> <p>Warranty: 6 Months</p>	<ul style="list-style-type: none"> Contoured design to isolate your Biceps Webbed nylon belt Dense pads ensure comfort and stability
BB23	Body-Solid Biceps Bomber	€ 49.00

	BAR PAD	SPECIFICATIONS
	<p>ITEM#: MA105</p> <p>Weight: 0.2 kg</p> <p>Dimensions: L 39.3 x W 9 x H 9 cm</p> <p>Warranty: 6 Months</p>	<ul style="list-style-type: none"> High-density foam padding with super-heavy nylon cover Fits all standard and Olympic bars Easy-on, Easy-off full length Velcro closure
MA105	Body-Solid Bar Pad	€ 25.00

	PREMIUM BAR PAD	SPECIFICATIONS
	<p>ITEM#: BSTBPAD</p> <p>Weight: 0.2 kg</p> <p>Dimensions: L 45 x W 10 x H 10 cm</p> <p>Warranty: 6 Months</p>	<ul style="list-style-type: none"> Ergonomic design for even weight distribution across shoulders Relieves neck pressure while squatting Useful for hip thrusts, lunges and more
BSTBPAD	Body-Solid Premium Bar Pad	€ 25.00

	NYLON WRIST WRAPS (PAIR)	SPECIFICATIONS
	<p>ITEM#: NB51</p> <p>Weight: 0.1 kg</p> <p>Dimensions: L 20.3 x W 6.3 x H 2.5 cm</p> <p>Warranty: 6 Months</p>	<ul style="list-style-type: none"> Sold in pairs Thick neoprene lining Easy-on, easy-off Velcro Best in wrist support Unmatched durability
NB51	Body-Solid Nylon Wrist Straps	€ 25.00

	NYLON POWER LIFTING STRAPS (PAIR)	SPECIFICATIONS
	<p>ITEM#: NB52</p> <p>Weight: 0.2 kg</p> <p>Dimensions: L 26 x W 9 x H 4.5 cm</p> <p>Warranty: 6 Months</p>	<ul style="list-style-type: none"> Sold in pairs Great for all lifting and pulling exercises Completely adjustable with a nylon web lining
NB52	Body-Solid Nylon Power Lifting Straps	€ 29.00

	DIPPING STRAP	SPECIFICATIONS
	<p>ITEM#: NB55</p> <p>Weight: 0.4 kg</p> <p>Dimensions: L 30.5 x W 1.9 x H 10.2 cm</p> <p>Warranty: 6 Months</p>	<ul style="list-style-type: none"> Used with any type of weightlifting belt Extra-heavy D rings 22.5 kg max capacity
NB55	Body-Solid Nylon Dipping Strap	€ 22.00

	NYLON DIPPING BELT	SPECIFICATIONS
	<p>ITEM#: NB56</p> <p>Weight: 0.6 kg</p> <p>Dimensions: L 47 x W 16 x H 2.5 cm</p> <p>Warranty: 6 Months</p>	<ul style="list-style-type: none"> Increases body weight for dips, chins, lunges, and holds you down for heavy lat pull downs Beveled edges will not dig, bite or bruise 22.5 kg max capacity
NB56	Body-Solid Nylon Dipping Belt	€ 35.00

	AB HARNESS	SPECIFICATIONS
	<p>ITEM#: ACH18</p> <p>Weight: 0.2 kg</p> <p>Dimensions: L 39 x W 4 x H 43 cm</p> <p>Warranty: 6 Months</p>	<ul style="list-style-type: none"> Protects the neck, shoulders, back and chest Comfortable foam grips Heavy-duty solid steel D ring
ACH18	Body-Solid AB Harness	€ 29.00

	WEIGHTLIFTING CHAINS (PAIR)	SPECIFICATIONS
	<p>ITEM#: BSTCH44</p> <p>Weight: 20 kg</p> <p>Dimensions: L 152.4 cm</p> <p>Warranty: 6 Months</p>	<ul style="list-style-type: none"> Pair of zinc-coated chains Offers scalable lifting resistance Perfect for use in squats, deadlifts and bench presses Fit any size Olympic barbell Attach to kettlebells, dumbbells and sleds or for bodyweight use
BSTCH44	Body-Solid Tools Weight Lifting Chains	€ 199.00

	ALUMINUM STRAIGHT BAR	SPECIFICATIONS
	<p>ITEM#: MB022A</p> <p>Weight: 0.6 kg</p> <p>Dimensions: L 50 x W 9 x H 4.5 cm</p> <p>Warranty: 6 Months</p>	<ul style="list-style-type: none"> Designed to attach to any cable or pulley-based machine High-strength, rust-proof, lightweight 31.75 mm aluminum Smooth, fluid center swivels & revolves Knurled grips
MB022A	Body-Solid Tools Aluminum Straight Bar	€ 45.00

	REVOLVING SOLID STRAIGHT BAR	SPECIFICATIONS
	<p>ITEM#: MB022RG</p> <p>Weight: 2.7 kg</p> <p>Dimensions: L 53.3 x W 3.8 x H 10.2 cm</p> <p>Warranty: 6 Months</p>	<ul style="list-style-type: none"> Provides a smooth motion and versatility for use in a wide range of workouts Solid Steel
MB022RG	Body-Solid Revolving Solid Straight Bar (Rubber Grip)	€ 55.00

	ALUMINUM DOUBLE SWIVEL BAR	SPECIFICATIONS
	<p>ITEM#: MB100A</p> <p>Weight: 1.6 kg</p> <p>Dimensions: L 106.5 x W 3.8 x H 3.8 cm</p> <p>Warranty: 6 Months</p>	<ul style="list-style-type: none"> Attaches to dual-stack functional trainers (PFT100, GDCC200 & GDCC210) High-strength, rust-proof, lightweight aluminum Dual Swivel for steady uninterrupted movements Knurled grips
MB100A	Body-Solid Aluminum Double Swivel Bar	€ 90.00

	ALUMINUM LAT BAR	SPECIFICATIONS
	<p>ITEM#: MB148A</p> <p>Weight: 1.5 kg</p> <p>Dimensions: L 122 x W 10 x H 4.5 cm</p> <p>Warranty: 6 Months</p>	<ul style="list-style-type: none"> Ideal for lat pulldowns, straight arm pulldowns.. Attach to any pulley or cable weight machine High-strength, rust-proof and lightweight 31.75 mm aluminum Rotating and swiveling center for more fluid motion
MB148A	Body-Solid Aluminum Lat Bar	€ 95.00

	LAT BAR	SPECIFICATIONS
	<p>ITEM#: MB148RG</p> <p>Weight: 5.8 kg</p> <p>Dimensions: L 124.5 x W 3.8 x H 17.8 cm</p> <p>Warranty: 6 Months</p>	<ul style="list-style-type: none"> • Smooth, fluid center swivel • Six knurl-textured rubber grips • Full 122 cm long Solid steel • For complete development of your lats, shoulders and arms
MB148RG	Body-Solid Lat Bar (Rubber Grip)	€ 65.00

	ALUMINUM CURL BAR	SPECIFICATIONS
	<p>ITEM#: MB229A</p> <p>Weight: 1 kg</p> <p>Dimensions: L 77.5 x W 9 x H 4.5 cm</p> <p>Warranty: 6 Months</p>	<ul style="list-style-type: none"> • Attach to home gym cable or pulley machine • Perform curls and other exercises • Angles designed for peak biceps and triceps contraction • High-strength, rust-proof and lightweight 31.75 mm aluminum • Rotating and swiveling center
MB229A	Body-Solid Aluminum Curl Bar	€ 85.00







	REVOLVING CURL BAR	SPECIFICATIONS
	<p>ITEM#: MB229RG</p> <p>Weight: 3.6 kg</p> <p>Dimensions: L 73.6 x W 3.8 x H 10.8 cm</p> <p>Warranty: 6 Months</p>	<ul style="list-style-type: none"> • Designed to fully isolate your biceps • Solid Steel
MB229RG	Body-Solid Revolving Curl Bar (Rubber Grip)	€ 59.00

	PRO STYLE LAT BAR 96.5 CM	SPECIFICATIONS
	<p>ITEM#: MB438RG</p> <p>Weight: 5.5 kg</p> <p>Dimensions: L 95.2 x W 14 x H 21.6 cm</p> <p>Warranty: 6 Months</p>	<ul style="list-style-type: none"> • Neutral grip for better lat development • Solid Steel
MB438RG	Body-Solid Pro Style Lat Bar -95 cm (Rubber Grip)	75.00



	STIRRUP HANDLE	SPECIFICATIONS
	<p>ITEM#: MB501RG</p> <p>Weight: 0.7 kg</p> <p>Dimensions: L 14 x W 3.5 x H 14 cm</p> <p>Warranty: 6 Months</p>	<ul style="list-style-type: none"> • Machined steel is accurately balanced for smooth operation • Heavy-duty welded flange for a lifetime of extreme usage • Solid Steel
MB501RG	Body-Solid Stirrup Handle (Rubber Grip)	€ 15.00

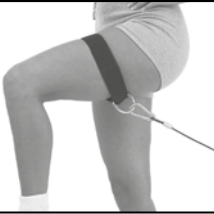

	SEATED ROW / CHIN BAR COMBO	SPECIFICATIONS
	<p>ITEM#: MB502RG</p> <p>Weight: 2.3 kg</p> <p>Dimensions: L 17.8 x W 14.6 x H 12 cm</p> <p>Warranty: 6 Months</p>	<ul style="list-style-type: none"> • All ends are precision-ground and polished to an exact radius • Heavy-duty welded flange for a lifetime of extreme usage • Solid Steel
MB502RG	Body-Solid Tools Seated Row / Chin Bar Combo (Rubber Grip)	€ 29.00

	SOLID MULTI-PURPOSE BAR	SPECIFICATIONS
	<p>ITEM#: MB503RG</p> <p>Weight: 3.6 kg</p> <p>Dimensions: L 38 x W 23.5 x H 15.2 cm</p> <p>Warranty: 6 Months</p>	<ul style="list-style-type: none"> • Extra chest clearance allows you to incorporate more muscle fibers in your lats • Not just for seated rows, also perform triceps press downs and bicep curls • Solid Steel
MB503RG	Body-Solid Tools Revolving Solid Multipurpose Bar (Rubber Grip)	€ 45.00

	TRICEPS PRESS DOWN BAR ITEM#: MB504RG Weight: 2.7 kg Dimensions: L 30.5 x W 7.6 x H 18.4 cm Warranty: 6 Months	SPECIFICATIONS <ul style="list-style-type: none"> • Designed for maximum triceps contraction • Solid steel welded flange allows maximum load capacity • Solid Steel
MB504RG	Body-Solid Tools Triceps Press Down Bar (Rubber Grip)	€ 29.00
	BALANCED V-BAR ITEM#: MB507RG Weight: 2.3 kg Dimensions: L 38 x W 3.8 x H 23.5 cm Warranty: 6 Months	SPECIFICATIONS <ul style="list-style-type: none"> • Ergonomically designed to provide continuous, consistent tension throughout • Center-balanced construction allows follow through movement at optimum resistance • Solid steel
MB507RG	Body-Solid Tools Balanced V-Bar (Rubber Grip)	€ 39.00
	ADJUSTABLE NYLON STIRRUP HANDLE ITEM#: NB59 Weight: N/A Dimensions: L 33 x W 14 x H 3.2 cm Warranty: 6 Months	SPECIFICATIONS <ul style="list-style-type: none"> • Ergonomically designed, textured grip • Heavy-duty nylon and rubber, with multiple steel D-rings
NB59	Body-Solid Tools Adjustable Nylon Cable Handle	€ 29.00
	STIRRUP WITH ALUMINUM HANDLE ITEM#: NB59A Weight: 0.1 kg Dimensions: L 33 x W 14 x H 3.2 cm Warranty: 6 Months	SPECIFICATIONS <ul style="list-style-type: none"> • Built-in D-rings to extend or shorten the distance of the attachment point to the handle grip • Heavy-duty steel D-rings to attach quickly and easily to carabiners or other equipment • Ergonomically-designed
NB59A	Body-Solid Stirrup with Aluminum Handle	€ 27.00
	NYLON ANKLE STRAP ITEM#: NAS3 Weight: 0.1 kg Dimensions: L 14 x W 7.5 x H 5 cm Warranty: 6 Months	SPECIFICATIONS <ul style="list-style-type: none"> • Attached to a low pulley for performing exercises like inner and outer thigh and glute kickbacks • Heavy-duty nylon construction • The inside of the Ankle Strap is lined with man-made wool padding
NAS3	Body-Solid Tools Nylon Ankle Strap	€ 19.00
	NYLON TRICEPS STRAP ITEM#: NTS10 Weight: N/A Dimensions: L 51 x W 2.7 x H 2.5 cm Warranty: 6 Months	SPECIFICATIONS <ul style="list-style-type: none"> • They feature edges that won't pinch, scrape or cut, and a patented neoprene lining that allows hands to "breathe" while in use. Both can be used for triceps press downs, ab crunches, bicep curls, triceps extensions, front and side deltoid raises and much more.
NTS10	Body-Solid Tools Nylon Triceps Strap	€ 14.00
	TRICEPS ROPE ITEM#: TR20 Weight: 0.8 kg Dimensions: L 76 x W 5.7 x H 5.7 cm Warranty: 6 Months	SPECIFICATIONS <ul style="list-style-type: none"> • Over-sized rubber blocks and super-thick, high-carbon steel swivel for strength, durability and comfort • Perform press downs, curls, crunches, kickbacks and deltoid raises
TR20	Body-Solid Tools Triceps Rope	€ 29.00

	THIGH STRAP	SPECIFICATIONS
	ITEM#: TS31 Weight: 0.1 kg Dimensions: L 26 x W 5 x H 2 cm Warranty: 6 Months	<ul style="list-style-type: none"> Designed specifically to target train the hips, thighs and buttocks Completely adjustable with comfortable neoprene lining and sure-lock Velcro closure
TS31	Body-Solid Tools Thigh Strap	€ 15.00

	ACCESSORY STAND	SPECIFICATIONS
	ITEM#: VDRA30 Weight: 30 kg Dimensions: L 47 x W 44.4 x H 102.2 cm Warranty: In-Home Lifetime / Light Commercial (P. 119)	 <ul style="list-style-type: none"> Stores and organizes multiple accessory bars, ropes, straps and even dumbbells Can hold 36 items Efficient and compact design
VDRA30	Body-Solid Accessory Stand	Accessories not included. € 265.00

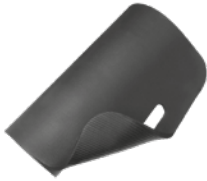

	BALL REBOUNDER	SPECIFICATIONS
	ITEM#: GBR10 Weight: 20 kg Dimensions: L 139.5 x W 120.4 x H 95.5 cm Warranty: In-Home Lifetime / Light Commercial (P. 119)	 <ul style="list-style-type: none"> Add variety to strength and cardio workouts Perfect for functional/cross training, circuits, sports performance or rehabilitation Adjustable 30 to 60 degree angle Perform medicine ball workouts without a partner
GBR10	Body-Solid Ball Rebounder	€ 415.00





	PREMIUM FOAM MAT	SPECIFICATIONS
	ITEM#: BSTFM10 Weight: 0.6 kg Dimensions: L 122 x W 51 x H 1.3 cm Warranty: 6 Months	<ul style="list-style-type: none"> Extra thick padding for superior comfort Straps for transport 1.3 cm thick Cut out handle opening
BSTFM10	Body-Solid Tools Thick Exercise Premium Foam Mat	€ 35.00

	PREMIUM HANGING FITNESS MAT	SPECIFICATIONS
	ITEM#: BSTFM20 Weight: 0.7 kg Dimensions: L 180 x W 58 x H 1.3 cm Warranty: 6 Months	<ul style="list-style-type: none"> For use with yoga, stretching, low impact and core-based exercises Reinforced eyelets to hang mat on wall or door Quality foam for durability and comfort Water-resistant & easy-to-clean, non-slip surface
BSTFM20	Body-Solid Tools Premium Hanging Fitness Mat	€ 49.00

	FITNESS MAT HANGER	SPECIFICATIONS
	ITEM#: BSTFMH Weight: 0.6 kg Dimensions: L 52 x W 18.3 x H 5 cm Warranty: 6 Months	<ul style="list-style-type: none"> For storage of BSTFM20 hanging exercise mats Can store up to 10 mats at once Quickly and easily attaches to wall Save space in workout facility 49 cm between prong centers
BSTFMH	Body-Solid Tools Fitness mat Hanager	€ 35.00

	YOGA MAT BLUE 3 MM	SPECIFICATIONS
	ITEM#: BSTYM3 Weight: 0.9 kg Dimensions: L 183 x W 61 x H 0.3 cm Warranty: 6 Months	<ul style="list-style-type: none"> Provide a stable, non-slip surface for your yoga or pilates Light-tack non-slip surface with cushioning Perfect for home or studio use 3 mm thickness
BSTYM3	Body-Solid Tools Yoga Mat Blue, 3 mm	€ 24.00

	YOGA MAT RED 5 MM	SPECIFICATIONS
	ITEM#: BSTYM5 Weight: 1.1 kg Dimensions: L 185 x W 61 x H 0.5 cm Warranty: 6 Months	<ul style="list-style-type: none"> • Provide a stable, non-slip surface for your yoga or pilates • Light-tack non-slip surface with cushioning • Perfect for home or studio use • 5 mm thickness
BSTYM5	Body-Solid Tools Yoga Mat Blue, 5 mm	€ 32.00
	YOGA MAT PREMIUM GREEN 6 MM	SPECIFICATIONS
	ITEM#: BSTYM10 Weight: 1.2 kg Dimensions: L 183 x W 61 x H 0.6 cm Warranty: 6 Months	<ul style="list-style-type: none"> • Made from durable high density PVC • Decorative pattern with specific spots for positioning & Repeating center line markers • 6 mm Thick
BSTYM10	Body-Solid Tools Premium Yoga Mat Green, 6 mm	€ 52.00

	CANNON BALL GRIPS	SPECIFICATIONS
	ITEM#: BSTCB Weight: 1.2 kg Dimensions: L 7.6 x W 7.6 x H 9.7 cm Warranty: 6 Months	<ul style="list-style-type: none"> • 7.6 mm diameter • Welded steel hook • Non slip red matte paint finish • Strong nylon strap • Sturdy carabiner for added safety, stability and customization • Quickly and easily attach
BSTCB	Body-Solid Tools Cannon Ball Grips	€ 45.00
	NUN-CHUCK GRIPS	SPECIFICATIONS
	ITEM#: BSTNG Weight: 1.3 kg Dimensions: L 5 x W 10 x H 38.6 cm Warranty: 6 Months	<ul style="list-style-type: none"> • Attached to kettlebell, weight plate or in rig system • Perfect for pull-ups, farmers walks and more • Textured-surface for safety and stability
BSTNG	Body-Solid Tools Nun-Chuck Grips	€ 45.00
	DOG BONE GRIP	SPECIFICATIONS
	ITEM#: BSTDB Weight: 1.8 kg Dimensions: L 37.5 x W 7.5 x H 7.5 cm Warranty: 6 Months	<ul style="list-style-type: none"> • Two unique surfaces for varied grip work Attach to grip plates, dumbbells, kettlebells, cable machines and more • Ideal for pull-ups and farmers walks
BSTDB	Body-Solid Tools Dog Bone Grips	€ 45.00
	GRIP TRAINERS	SPECIFICATIONS
	ITEM#: BSTGT Weight: 0.2 kg Dimensions: L 2.5 x W 10.5 x H 13 cm Warranty: 6 Months	<ul style="list-style-type: none"> • Two unique surfaces for varied grip work Attach to grip plates, dumbbells, kettlebells, cable machines and more • Ideal for pull-ups and farmers walks
BSTGT100	Resistance level 45 kg (Colour Red)	€ 16.00
BSTGT150	Resistance level 68 kg (Colour Blue)	€ 18.00
BSTGT200	Resistance level 90 kg (Colour Black)	€ 20.00

	LAT-BLASTER BAR	SPECIFICATIONS
	<p>ITEM#: LBB28</p> <p>Weight: 2.1 kg</p> <p>Dimensions: L 77.5 x W 12.7 x H 3.5 cm</p> <p>Warranty: 6 Months</p>	<ul style="list-style-type: none"> • Designed for specific Latissimus isolation • Use with the T-Bar Row Platform TBR10/TBR20 • Works with Olympic 50 mm and Standard Bars 25 mm
LBB28	Body-Solid Tools Lat-Blaster Bar	€ 54.00

	LANDMINE CLUB GRIP	SPECIFICATIONS
	<p>ITEM#: LMCG</p> <p>Weight: 3.1 kg</p> <p>Dimensions: L 59.5 x W 12.5 x H 7.5 cm</p> <p>Warranty: 6 Months</p>	<ul style="list-style-type: none"> • Contoured ball handle for comfort and safety • 2.5 cm handle allows comfort to users with smaller hands • Easy lock-down knob for safety • Works with Olympic bars
LMCG	Body-Solid Tools Landmine Club Grip	€ 75.00

	LANDMINE SINGLE EYELET	SPECIFICATIONS
	<p>ITEM#: LMSE</p> <p>Weight: 1.1 kg</p> <p>Dimensions: L 11 x W 11.5 x H 6 cm</p> <p>Warranty: 6 Months</p>	<ul style="list-style-type: none"> • Easily connects to any Machine-Use attachment bar for a variety of workouts • 29 cm of range from sleeve to end of snap link • Portable design • Works with Olympic bars
LMSE	Body-Solid Tools Landmine Single Eyelet	€ 29.00

	LANDMINE PLATE PIVOT	SPECIFICATIONS
	<p>ITEM#: LMPP</p> <p>Weight: 2 kg</p> <p>Dimensions: L 45 x W 10 x H 6 cm</p> <p>Warranty: 6 Months</p>	<ul style="list-style-type: none"> • 18 cm base post easily slides into stacked 20 kg Plates • 360-degree pivot allows comfortable rotation • 7 gauge steel – suitable for gyms • Works with Olympic Bars
LMPP	Body-Solid Tools Landmine Plate Pivot	€ 45.00

	LANDMINE MULTI-GRIP	SPECIFICATIONS
	<p>ITEM#: LMMG</p> <p>Weight: 3.63 kg</p> <p>Dimensions: L 112 x W 24 x H 20.5 cm</p> <p>Warranty: 6 Months</p>	<ul style="list-style-type: none"> • Three grip positions: Neutral, wide and standard grips to isolate upper body muscles • Long handle for full range-of-motion • 17 cm handles for full and peak contraction • Works with Olympic Bars
LMMG	Body-Solid Tools Landmine Multi-Grip	€ 110.00

	OLYMPIC LOADING PIN	SPECIFICATIONS
	<p>ITEM#: BSTOLP</p> <p>Weight: 1 kg</p> <p>Dimensions: L 9 x W 9 x H 30 cm</p> <p>Warranty: 6 Months</p>	<ul style="list-style-type: none"> • Pin of 25.4 cm • Connect to carabiner for grip training workouts • Connect to weight belt for elevated belt squats • Black powder coat finish
BSTOLP	Body-Solid Olympic Loading Pin	€ 45.00

	T BAR ROW PLATFORM	SPECIFICATIONS
	<p>ITEM#: TBR10</p> <p>Weight: 3 kg</p> <p>Dimensions: L 26.7 x W 12.7 x H 15.8 cm</p> <p>Warranty: 6 Months</p>	<ul style="list-style-type: none"> • Durable solid steel axle pivot with bronze oil-lite bushings • Base anchors to 5 cm power rack or door frame • Works with Olympic and Standard Bars 25 mm
TBR10	Body-Solid Tools T-Bar Row Platform	€ 85.00

T-BARS

	T-BAR ROW PLATFORM, DUAL SWIVEL	SPECIFICATIONS
	<p>ITEM#: TBR20</p> <p>Weight: 3.9 kg</p> <p>Dimensions: L 25 x W 19 x H 26.2 cm</p> <p>Warranty: 6 Months</p>	<ul style="list-style-type: none"> • Dual axis pivot for full 360° rotations • Durable solid steel axle pivots with bronze oil-lite bushings • Adjustable base anchors to 5 or 7.6 cm power racks or door frames • Works with Olympic 50 mm and Standard Bars 25 mm
TBR20	Body-Solid Tools T-Bar Row Platform, Dual Swivel	€ 89.00

	T-BAR ROW PLATFORM	SPECIFICATIONS
	<p>ITEM#: TBR50</p> <p>Weight: 14 kg</p> <p>Dimensions: L 58.4 x W 38.1 x H 12.7 cm</p> <p>Warranty: 6 Months</p>	<ul style="list-style-type: none"> • Heavy-gauge steel construction • Free-flowing 360-degree pivot sleeve • Accommodates any Olympic barbell • Bolt to floor for stability or keep unbolted for portability • Rope anchor for attaching fitness ropes
TBR50	Body-Solid Tools T-Bar Row Platform	€ 159.00

FLOORING

	4 PIECE PUZZLE MAT	SPECIFICATIONS
	<p>ITEM#: RFBST4PB</p> <p>Weight: 9 kg</p> <p>Dimensions: 4 pieces of 50 x 50 X 1.1 cm</p> <p>Warranty: 6 Months</p>	<ul style="list-style-type: none"> • Protects floors and equipment • High-quality malaysian rubber • Easy to install • Each pack contains 4 pieces of 50 cm x 11 mm • Minimum odor • Reduces noise
RFBST4PB	Body-Solid Tools 4 Piece Puzzle Mat, Black	€ 75.00

	SPECKLED PUZZLE MATS	SPECIFICATIONS
	<p>ITEM#: RFBST4PS</p> <p>Weight: 11.8 kg</p> <p>Dimensions: 4 pieces of 50 x 50 X 1.1 cm</p> <p>Warranty: 6 Months</p>	<ul style="list-style-type: none"> • Protects floors and equipment • High-quality malaysian rubber • Easy to install • Each pack contains 4 pieces of 50 cm x 11 mm • Minimum odor • Reduces noise
RFBST4PS	Body-Solid Tools Speckled Puzzle mats	€ 85.00

	PROTECTIVE RUBBER FLOORING	SPECIFICATIONS
	<p>ITEM#: RF546</p> <p>Weight: 31 kg</p> <p>Dimensions: L 182.8 x W 122 x H 1.3 cm</p> <p>Warranty: 6 Months</p>	<ul style="list-style-type: none"> • Heavy-duty solid rubber construction • Installation is easy—no adhesive, no interlocking tabs • Black color is non-glaring for a soft, satin appearance
RF546	Body-Solid Tools Protective Rubber Flooring	€ 129.00

	RUBBER BIKE / EXERCISE MAT	SPECIFICATIONS
	<p>ITEM#: RF34B</p> <p>Weight: 2.3 kg</p> <p>Dimensions: L 122 x W 91.5 x H 0.3 cm</p> <p>Warranty: 6 Months</p>	<ul style="list-style-type: none"> • Tough, durable PVC material • Dampens vibrations that cause wear and tear to equipment • Helps protect your floors and carpets from heavy exercise equipment
RF34B	Body-Solid Tools Rubber Bike / Exercise Mat	Bike not included! € 49.00

	RUBBER TREADMILL MAT	SPECIFICATIONS
	<p>ITEM#: RF36T</p> <p>Weight: 3.7 kg</p> <p>Dimensions: L 198 x W 91.5 x H 0.3 cm</p> <p>Warranty: 6 Months</p>	<ul style="list-style-type: none"> • Tough, durable PVC material • Dampens vibrations that cause wear and tear to equipment • Helps protect your floors and carpets from heavy exercise equipment
RF36T	Body-Solid Tools Rubber Treadmill Mat	€ 69.00

	ROWER MAT	SPECIFICATIONS
	<p>ITEM#: RF38R</p> <p>Weight: 3.63 kg</p> <p>Dimensions: L 259 x W 91.5 x H 0.3 cm</p> <p>Warranty: 6 Months</p>	<ul style="list-style-type: none"> • Made of super tough, durable PVC • Helps protect your floors and carpets • Dampens vibrations • Perfect for rowers, treadmills, ellipticals, and other longer cardio equipment • Cleans easily with a damp cloth
RF38R	Body-Solid Tools Rower Mat	Rower not included! € 89.00

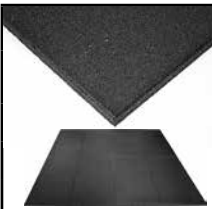

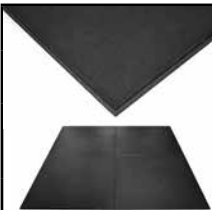



	FUNCTIONAL TRAINING FLOORING	SPECIFICATIONS
	<p>ITEM#: RFL2</p> <p>Dimensions: L 100 x W 100 x H 2 cm</p> <p>Pallet L 105 x W 105 x H 120 cm</p> <p>Warranty: 6 Months</p>	<ul style="list-style-type: none"> • Flat tile, made by fine rubber grains bonded with a high-resistance polyurethane glue. • Density: about 980 kg/m³ • Resistant to mold and bacteria according to the norm UNI 11021:2002.Reduces noise • Cold/heat resistance: -50°C/100°C
RFL2	Functional Training Surface	€ 69.00



	FUNCTIONAL TRAINING FLOORING PRO	SPECIFICATIONS
	<p>ITEM#: RFL2-PRO</p> <p>Dimensions: L 100 x W 100 x H 2 cm</p> <p>Pallet L 105 x W 105 x H 120 cm</p> <p>Warranty: 6 Months</p>	<ul style="list-style-type: none"> • Flat tile, made by fine rubber grains bonded with a high-resistance polyurethane glue. • Density: about 1000 kg/m³ • Resistant to mold and bacteria according to the norm UNI 11021:2002.Reduces noise • Cold/heat resistance: -50°C/100°C
RFL2-PRO	Professional Functional Training Surface	€ 79.00

	SPIRITFITNESS TREADMILL MAT	SPECIFICATIONS
	<p>ITEM#: TRMAT</p> <p>Weight</p> <p>Dimensions: L 213 x W 94 cm</p> <p>Warranty: 6 Months</p>	<ul style="list-style-type: none"> • Can be used under most fitness machines • The 6 mm thick mat dampens vibrations and reduces noise • Sturdy and durable design helps protect floors from scratches and dents • Easy to clean and disinfect
TRMAT	Spirit Fitness Treadmill Mat	€ 31.50

	3-WAY WOODEN PLYO BOX	SPECIFICATIONS
	ITEM#: BSTWPBOX Weight: 26 kg Dimensions: L 51 x W 61 x H 76.2 cm Warranty: 6 Months	<ul style="list-style-type: none"> • Solid wood construction • Unique three-sided design, like getting three different plyo boxes in one • Three diverse heights allow you to customize your workout and adjust on the fly.
BSTWPBOX	Body-Solid Tools 3-Way Wooden Plyo Box	€ 259.00

	SOFT PLYO BOX 50/60/75CM	SPECIFICATIONS
	ITEM#: BSTSPBOX Weight: 6.6 kg Dimensions: L 61 x W 51 x H 76.2 cm Warranty: 6 Months	<ul style="list-style-type: none"> • Unique three-sided design, like getting three different plyo boxes in one • Durable vinyl cover resists wear and tear • Reinforced soft foam sides minimize the potential for banged shins and scrapes
BSTSPBOX	Body-Solid Tools Soft Plyo Box	€ 499.00





PLYO BOXES						
						
ITEM#: BSTPB Body-Solid Tools Plyo Box Warranty: 6 Months				<ul style="list-style-type: none"> • Feature heavy-duty 2.5 cm square steel construction • The platforms are reinforced 1.25 cm plywood covered in nonslip rubber surface • 136 kg weight capacity • Nest together for storage 		
	Height (cm)	Weight (kg)	Base (cm)	Platform (cm)		
BSTPB6	15.3	4.5	30.5 x 30.5	25 x 25		€ 135.00
BSTPB12	30.5	8.1	43 x 43	28.7 x 28.7		€ 165.00
BSTPB18	45.7	10	51 x 51	34.8 x 34.8		€ 180.00
BSTPB24	61	12.7	61 x 61	40.8 x 40.8		€ 200.00
BSTPB30	76	15	66 x 66	46.7 x 46.7		€ 220.00
BSTPB36	91.5	17.2	76 x 76	52.8 x 52.8		€ 245.00
BSTPB42	106.5	20	84 x 84	58.8 x 58.8		€ 285.00

	COMMERCIAL WEIGHT SLED	SPECIFICATIONS
	ITEM#: GWS100 Weight: 1 kg Dimensions: L 106.2 x W 77.6 x H 101 cm / Ø 50 mm Warranty: Full Commercial (P. 119)	 <ul style="list-style-type: none"> • Removable Posts • Heavy Gauge Steel Frame • Center weight horn • Multiple handles to push and pull • Attachment Anchors
GWS100	Body-Solid Weight Sled	€ 379.00

BATTLE ROPES						
	ITEM#: BSTBR Body-Solid Tools Battle Ropes Warranty: 6 Months				<ul style="list-style-type: none"> All ropes are made of durable poly-twine Wrapped finished ends adds durability For both indoor and outdoor training. Training can be done with individual users or couples 	
	Code	Length	Weight	Diameter		
BSTBR1530	915 cm	6 kg	3.8 cm			€ 160.00
BSTBR1550	1524 cm	10 kg	3.8 cm			€ 250.00
BSTBR2030	915 cm	9 kg	5 cm			€ 275.00
BSTBR2050	1524 cm	15. kg	5 cm			€ 460.00

RESISTANCE POWER BANDS					
					
ITEM#: BSTB Body-Solid Tools Resistance Bands Warranty: 6 Months				<ul style="list-style-type: none"> BSTB1 and BSTB2 are best used for general conditioning, stretching, rehabilitation, jumping, aerobics and for bicep /tricep exercises For stronger bench presses and lower body exercises, the BSTB3 and BSTB4 For obtaining maximum resistance for squats, deadlifts, leg presses and shrugs, use the BSTB5 	
Code	Colour	Resistance	Dimensions		
BSTB1	Orange	Very light	103 x 1.27 x 1 cm		€ 25.00
BSTB2	Green	Light	103 x 1.9 x 1 cm		€ 35.00
BSTB3	Red	Medium	103 x 2.8 x 1 cm		€ 49.00
BSTB4	Blue	Heavy	103 x 4.4 x 1 cm		€ 75.00
BSTB5	Purple	Very Heavy	103 x 6.3 x 1 cm		€ 99.00



MINI BANDS						
	ITEM#: BSTBM Body-Solid Tools Mini Bands Warranty: 6 Months				<ul style="list-style-type: none"> Build total body strength, coordination and balance Secure to ankles, knees, calves, hips and glutes for lower body conditioning Comprehensive all-body exercise tool Available in five resistance levels Made with snap-resistant rubber 	
	Code	Colour	Resistance	Dimensions		
BSTBM1	Yellow	Ultra light	25 x 5 x 0.5 cm		€ 2.00	
BSTBM2	Green	Light	25 x 5 x 0.5 cm		€ 3.00	
BSTBM3	Red	Medium	25 x 5 x 0.5 cm		€ 4.00	
BSTBM4	Blue	Heavy	25 x 5 x 0.5 cm		€ 5.00	
BSTBM5	Black	Ultra Heavy	25 x 5 x 0.5 cm		€ 6.00	
BSTBM-PACK					€ 20.00	

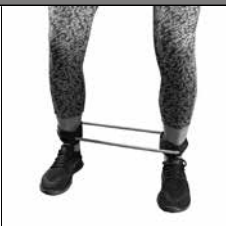

RESISTANCE TUBES					
					
ITEM#: BSTRT Body-Solid Tools Resistance Tubes Warranty: 6 Months				<ul style="list-style-type: none"> • For strength training and rehabilitation • Their elastic properties give you varying levels of intensity, and a full range of motion • All are 155 cm handle to handle 	
Code	Colour	Resistance	Dimensions		
BSTRT1	Yellow	Very Light	160 x 12.7 x 3 cm		€ 19.00
BSTRT2	Green	Light	160 x 12.7 x 3 cm		€ 21.00
BSTRT3	Red	Medium	160 x 12.7 x 3 cm		€ 22.00
BSTRT4	Blue	Heavy	160 x 12.7 x 3 cm		€ 24.00
BSTRT5	Black	Very Heavy	160 x 12.7 x 3 cm		€ 25.00

ANKLE CUFF RESISTANCE TUBES					
					
ITEM#: BSTART Body-Solid Ankle Cuff Resistance Tubes Warranty: 6 Months				<ul style="list-style-type: none"> • Strength, tone and work your lower body • Full range-of-motion for effective training • Soft-padded ankle cuffs • Durable exterior • Hook & loop closure for secure fit 	
Code	Colour	Resistance	Circumference		
BSTART1	Yellow	Very Light	91.5 cm		€ 17.00
BSTART2	Green	Light	91.5 cm		€ 18.00
BSTART3	Red	Medium	91.5 cm		€ 19.00
BSTART4	Blue	Heavy	91.5 cm		€ 20.00
BSTART5	Black	Very Heavy	91.5 cm		€ 21.00

	RESISTANCE TUBES DOOR ATTACHMENT		SPECIFICATIONS
	ITEM#: BSTRTDA Dimensions: L 21.5 x W 3.8 x H 2 cm Warranty: 6 Months		<ul style="list-style-type: none"> • Increase your resistance tube exercise options • Perfect for chest press, shoulder press, back fly, ab crunch and more • Excellent workout option for home and travelling • Lightweight and easy to use • Heavy duty nylon ensures safety and stability
BSTRTDA	Body-Solid Tools resistance Tubes Door Attachment		€ 10.00

FITNESS BARS					
	ITEM#: BSTFB Body-Solid Tools Fitness Bars			<ul style="list-style-type: none"> • Rubber padded weighted bar • Rubber end caps are color-coded by weight • Weight designations are permanently embossed onto end caps • Perfect for a variety of personal or group exercises 	
	Warranty: 6 Months				
Code	Colour	Weight	Dimensions		
BSTFB4	Orange	1.8 kg	124.5 x 4.7 x 4.7 cm		€ 49.00
BSTFB6	Light Purple	2.7 kg	124.5 x 4.7 x 4.7 cm		€ 55.00
BSTFB9	Yellow	4 kg	124.5 x 4.7 x 4.7 cm		€ 63.00
BSTFB12	Green	5.4 kg	124.5 x 4.7 x 4.7 cm		€ 75.00
BSTFB15	Red	6.8 kg	124.5 x 4.7 x 4.7 cm		€ 85.00
BSTFB18	Blue	8.2 kg	124.5 x 4.7 x 4.7 cm		€ 90.00
BSTFB24	Purple	10.9 kg	124.5 x 4.7 x 4.7 cm		€ 115.00
BSTFB30	Magenta	13.6 kg	151.5 x 4.7 x 4.7 cm		€ 135.00
BSTFB36	Light Grey	16.3 kg	181.5 x 4.7 x 4.7 cm		€ 160.00



FITNESS BAR RACK		SPECIFICATIONS	
	ITEM#: GFR500		 <ul style="list-style-type: none"> • Compact, stable and affordable • Vertical storage for up to 30 Fitness Bars • Stores Fitness Bars from 2 kg up to 16 kg
	Weight:	17 kg	
Dimensions:	L 71.9 x W 61.2 x H 109 cm		
Warranty:	In-Home Lifetime / Light Commercial (P. 119)		
GFR500	Body-Solid Fitness Bar Rack		€ 239.00

MEDICINE BALLS				
	ITEM#: BSTMB Body-Solid Tools Medicine Balls			 <p>Previous model</p> <ul style="list-style-type: none"> • Color coded with resistance ranging from 0.9 kg to 13.6 kg • They bounce and maintain their shape, and are extremely durable • Textured surface ensures superior grip and handling
	Warranty: 6 Months			
Code	Colour	Weight	Diameter	
BSTMB2	Purple	900 g	20 cm	€ 45.00
BSTMB4	Yellow	1.8 kg	20 cm	€ 50.00
BSTMB6	Aqua	2.7 kg	22 cm	€ 55.00
BSTMB8	Red	3.6 kg	22 cm	€ 60.00
BSTMB10	Blue	4.4 kg	23 cm	€ 65.00
BSTMB12	Grey	5.4 kg	25.5 cm	€ 75.00
BSTMB14	Orange	6.3 kg	27 cm	€ 90.00
BSTMB16	Green	7.2 kg	28.5 cm	€ 100.00
BSTMB20	Dark Blue	9.0 kg	28.5 cm	Previous model <i>As long as stocks last!</i> € 140.00
BSTMB25	Black	11.3 kg	28.5 cm	Previous model <i>As long as stocks last!</i> € 200.00
BSTMB30	Black	13.6 kg	28.5 cm	Previous model <i>As long as stocks last!</i> € 220.00



DUAL GRIP MEDICINE BALLS					
	ITEM#: BSTDMB Body-Solid Tools Dual Grip Medicine Balls Warranty: 6 Months			<ul style="list-style-type: none"> • Dual Grip Medicine balls are made with durable rubber and easy-grip handles • Can be used for both one-handed and two-handed exercises • Are ideal for replicating a number of sports movements • Each dual grip medicine ball features a 30.5 cm diameter 	
	Code	Colour	Weight	Diameter	
BSTDMB6	Black	2.7 kg	30.5 cm		€ 89.00
BSTDMB8	Black	3.6 kg	30.5 cm		€ 99.00
BSTDMB10	Black	4.4 kg	30.5 cm		€ 109.00
BSTDMB12	Black	5.4 kg	30.5 cm		€ 125.00
BSTDMB14	Black	6.3 kg	30.5 cm		€ 139.00
BSTDMB16	Black	7.2 kg	30.5 cm		€ 149.00
BSTDMB18	Black	8.0 kg	30.5 cm		€ 169.00
BSTDMB20	Black	9.0 kg	30.5 cm		€ 189.00
BSTDMB25	Black	11.3 kg	30.5 cm		€ 259.00

WALL BALLS					
	ITEM#: BSTSMB Body-Solid Tools Balls Warranty: 6 Months			<ul style="list-style-type: none"> • Soft-shell construction absorbs impact while maintaining shape and weight balance • Perfect for strength and endurance exercises such as throws, squats, cleans and chops • Each medicine ball features a 35.5 cm diameter regardless of weight 	
	Code	Weight	Diameter		
BSTSMB6	2.7 kg	35.5 cm			€ 80.00
BSTSMB8	3.6 kg	35.5 cm			€ 85.00
BSTSMB10	4.5 kg	35.5 cm			€ 90.00
BSTSMB12	5.4 kg	35.5 cm			€ 95.00
BSTSMB14	6.4 kg	35.5 cm			€ 100.00
BSTSMB16	7.3 kg	35.5 cm			€ 105.00
BSTSMB18	8.1 kg	35.5 cm			€ 110.00
BSTSMB20	9.0 kg	35.5 cm			€ 115.00
BSTSMB25	11.3 kg	35.5 cm			€ 120.00
BSTSMB30	13.6 kg	35.5 cm			€ 125.00

	MEDICINE BALL RACK		SPECIFICATIONS	
	ITEM#: GMR5 Weight: 4.6 kg Dimensions: L 54.7 x W 54.7 x H 83 cm Warranty: In-Home Lifetime		<ul style="list-style-type: none"> • The rack fits medicine balls from 2lbs to • For medicine balls from 900 g to 7,2 kg or dualgrip balls from 2,7 kg to 9 kg • The two rings are adjustable 360 ° for perfect placement in any room. • Customizable, Stable and Affordable 	
GMR5	Body-Solid Medicine Ball Rack			€ 90.00

	MEDICINE BALL RACK		SPECIFICATIONS	
	ITEM#: GMR10 Weight: 13 kg Dimensions: L 57 x W 49.5 x H 158 cm Warranty: In-Home Lifetime / Light Commercial (P. 119)			<ul style="list-style-type: none"> • Vertical storage for up to 6 Medicine Balls or • 6 Dual Grip Medicine Balls • 6 storage posts; for medicine balls from 900g to 7,2 kg or dualgrip balls from 2,7 kg to 9 kg • Curved oval upright allows for easy access to every tier
GMR10	Body-Solid Medicine Ball Rack			€ 195.00

STABILITY BALLS + PUMP					
	ITEM#: BSTSB Body-Solid Tools Stability Balls Warranty: 6 Months			<ul style="list-style-type: none"> • Non bounce No-roll construction • Trains Sports Specific Movements • Widely used in rehabilitation • Strengthens the Core 	
	Code	Colour	Diameter		
BSTSB45	Green	45 cm			€ 30.00
BSTSB55	Gray	55 cm			€ 30.00
BSTSB65	Red	65 cm			€ 35.00
BSTSB75	Blue	75 cm			€ 35.00

	STABILITY BALL RACK		SPECIFICATIONS	
	ITEM#: GSR10 Weight: 13.7 kg Dimensions: L 80.5 x W 91.2 x H 186.5 cm Warranty: In-Home Lifetime / Light Commercial (P. 119)			<ul style="list-style-type: none"> • The compact design fits into any corner • Allows easy access for all 3 stability balls • Made from heavy gauge steel • Customizable, Stable and Affordable
GSR10	Body-Solid Stability Ball Rack			

SLAM BALLS					
	ITEM#: BSTHB Body-Solid Tools Slam Balls Warranty: 6 Months			<ul style="list-style-type: none"> • Non bounce No-roll construction • Trains Sports Specific Movements • Widely used in rehabilitation • Strengthens the Core 	
	Code	Weight	Diameter		
BSTHB10	4.6 kg	25 cm			€ 48.00
BSTHB15	6.8 kg	25 cm			€ 62.00
BSTHB20	9.7 kg	25 cm			€ 75.00
BSTHB25	11.3 kg	25 cm			€ 85.00
BSTHB30	13.6 kg	25 cm			€ 95.00

TIRE-TREAD SLAM BALLS					
	ITEM#: BSTTT Body-Solid Tools Tire-Tread Slam Balls Warranty: 6 Months			<ul style="list-style-type: none"> • Build strength, cardio endurance and explosive power • Textured, grooved surface for easy handling • Thick & durable rubber shell • Ideal for various throwing and slamming routines • Available in three sizes 	
	Code	Weight	Diameter		
BSTTT10	4.5 kg	23 cm			€ 62.00
BSTTT15	6.8 kg	23 cm			€ 69.00
BSTTT20	9.1 kg	23 cm			€ 79.00

HEAVY RUBBER BALLS					
	ITEM#: BSTHRB Body-Solid Tools Heavy Rubber Balls Warranty: 6 Months			<ul style="list-style-type: none"> • Heavy-rubber construction • Durable, never break open or lose shape • Consistent center of gravity • 6 weight options • Color-coding and weight displays (lbs. and kgs.) • Easy-grip rubber, no seams and no stitching • Perfect for use in wall ball workouts, squats, partner/group tosses & slam ball and medicine ball exercises 	
	Code	Colour	Weight	Diameter	
BSTHRB20	Purple	9 kg	34.5 cm		€ 119.00
BSTHRB30	Yellow	14 kg	34.5 cm		€ 159.00
BSTHRB40	Green	18 kg	34.5 cm		€ 199.00
BSTHRB50	Red	23 kg	34.5 cm		€ 249.00
BSTHRB60	Blue	27 kg	34.5 cm		€ 279.00
BSTHRB70	Grey	32 kg	34.5 cm		€ 319.00

HEXAGON RUBBER DUMBBELL PER PAIR				
	ITEM#: HEXRU Body-Solid Pro Style Rubber Dumbbells per pair			<ul style="list-style-type: none"> • Solid cast iron with a hex design prevents rolling • Heads are securely fastened and encased in virgin rubber • Dumbbells feature extra-thick, knurled Contour handles
	Warranty: 6 Months			
Code	Weight			
HEXRU1	1 kg			€ 8.00
HEXRU2	2 kg			€ 18.00
HEXRU3	3 kg			€ 27.00
HEXRU4	4 kg			€ 36.00
HEXRU5	5 kg			€ 45.00
HEXRU6	6 kg			€ 54.00
HEXRU7	7 kg			€ 63.00
HEXRU8	8 kg			€ 72.00
HEXRU9	9 kg			€ 81.00
HEXRU10	10 kg			€ 90.00
HEXRU12-5	12.5 kg			€ 112.50
HEXRU15	15 kg			€ 135.00
HEXRU17-5	17.5 kg			€ 157.50
HEXRU20	20 kg			€ 180.00
HEXRU22-5	22.5 kg			€ 202.50
HEXRU25	25 kg			€ 225.00
HEXRU27-5	27.5 kg			€ 247.50
HEXRU30	30 kg			€ 270.00
HEXRU32-5	32.5 kg			€ 292.50
HEXRU35	35 kg			€ 315.00
HEXRU37,5	37.5 kg			€ 337.50
HEXRU40	40 kg			€ 360.00
HEXRU42,5	42.5 kg			€ 382.50
HEXRU45	45 kg			€ 405.00
HEXRU47,5	47.5 kg			€ 427.50
HEXRU50	50 kg			€ 450.00
HEXDU1-10	1 to 10 kg	No Rack		€ 495.00
HEXDU-SETREK	1 to 10 kg	Rack included		€ 925.00

SADDLE RACK - 10 PAIRS		SPECIFICATIONS		
	ITEM#: SADRACK			<ul style="list-style-type: none"> • Designed for Pro-Style & round head dumbbells • Commercial quality • Holds 10 pairs of dumbbells • Protective rubber encased dumbbell saddles • Weight Capacity: 900 kg • Rubber feet to protect floors
	Weight:	55 kg		
Dimensions:	L 244 x W 66 x H 81 cm			
Warranty:	6 Months			
SADRACK	Bodytrading Saddle Rack 10 Pairs			€ 445.00

VINYL DUMBBELLS				
	ITEM#: BSTVDK Body-Solid Tools Vinyl Dumbbells Warranty: 6 Months			<ul style="list-style-type: none"> • Durable vinyl coating • Bright, color-coordinated weight increments • Ideal for a variety of personal or group exercises, including jogging & power walking, aerobics, physical therapy, yoga routines... • No-roll hex-ends • Incremental weights between 0.5 kg and 6 kg • Weight designations are stamped onto barbell ends, sweat and cleaning will not wear them off
	Code	Colour	Weight	
BSTVDK0.5	Pink	0.5 kg		€ 6.00
BSTVDK1	Light Purple	1 kg		€ 12.00
BSTVDK1.5	Green	1.5 kg		€ 16.00
BSTVDK2	Blue	2 kg		€ 22.00
BSTVDK2.5	Red	2.5 kg		€ 26.00
BSTVDK3	Dark Purple	3 kg		€ 32.00
BSTVDK4	Yellow	4 kg		€ 42.00
BSTVDK5	Orange	5 kg		€ 52.00
BSTVDK6	Magenta	6 kg		€ 62.00

CHICAGO EXTREME BUMPER PLATES

	ITEM#: OBPXK Body-Solid Chicago Extreme Bumper Plates Black 50 mm			<ul style="list-style-type: none"> • Superior durability in any facility • Diameter 450 mm, IWF standard • The OBPXK plates have a thinner width • Collar Opening 50.7 mm • Smooth Black Finish • Suitable for commercial use
	Warranty: 1 year Commercial			
Code	Colour	Weight	Dimensions	
OBPXK5	Black	5 kg	45 x 2.6 cm	€ 42.00
OBPXK10	Black	10 kg	45 x 3.1 cm	€ 57.00
OBPXK15	Black	15 kg	45 x 4.8 cm	€ 75.00
OBPXK20	Black	20 kg	45 x 6.1 cm	€ 90.00
OBPXK25	Black	25 kg	45 x 7.4 cm	€ 115.00

CHICAGO EXTREME COLORED BUMPER PLATES

	ITEM#: OBPXCK Body-Solid Chicago Extreme Bumper Plates Colored 50 mm			<ul style="list-style-type: none"> • Superior durability in any facility • Diameter 450 mm, IWF standard • Collar opening: 50.7 mm • Five size/color options: 5 kg (green), 10 kg (black), 15 kg (yellow), 20 kg (blue) and 25 kg (red) • Suitable for commercial use
	Warranty: 1 year Commercial			
Code	Colour	Weight	Dimensions	
OBPXCK5	Black	5 kg	45 x 2.6 cm	€ 42.00
OBPXCK10	Green	10 kg	45 x 3.1 cm	€ 68.00
OBPXCK15	Yellow	15 kg	45 x 4.8 cm	€ 89.00
OBPXCK20	Blue	20 kg	45 x 6.1 cm	€ 115.00
OBPXCK25	Red	25 kg	45 x 7.4 cm	€ 150.00

OLYMPIC RUBBER PLATES 4 GRIP 50 MM

	ITEM#: ORTK Body-Solid Olympic Rubber Plates 4 Grip 50 mm			<ul style="list-style-type: none"> • Encased in heavy impact-resistant rubber • Quad-grip design for safer and easier performance • Impervious to rusting, chipping, flaking or losing their color • Metal sleeve provides secure fit onto an Olympic bar
	Warranty: 6 Months			
Code	Colour	Weight	Dimensions	
ORTK1.25	Black	1.25 kg	Ø 18 x 2.5 cm	€ 6.00
ORTK2.50	Black	2.50 kg	Ø 21 x 3.1 cm	€ 12.00
ORTK5	Black	5 kg	Ø 27 x 3.8 cm	€ 24.00
ORTK10	Black	10 kg	Ø 35 x 4.4 cm	€ 48.00
ORTK15	Black	15 kg	Ø 40 x 4.7 cm	€ 72.00
ORTK20	Black	20 kg	Ø 44.5 x 5 cm	€ 95.00
ORTK25	Black	25 kg	Ø 44.5 x 9 cm	€ 120.00

OLYMPIC COLORED RUBBER PLATES 4 GRIP 50 MM

	ITEM#: ORCK Body-Solid Olympic Colored Rubber Plates 4 Grip 50 mm Warranty: 6 Months			<ul style="list-style-type: none"> • Encased in heavy impact-resistant rubber • Quad-grip design for safer and easier performance • Impervious to rusting, chipping, flaking or losing their color • Metal sleeve provides secure fit onto an Olympic bar 	
	Code	Colour	Weight	Dimensions	
ORCK1.25	Dark Grey	1.25 kg	Ø 18 x 2.5 cm		€ 6.25
ORCK2.50	Dark Blue	2.50 kg	Ø 21 x 3.1 cm		€ 13.00
ORCK5	Black	5 kg	Ø 27 x 3.8 cm		€ 26.00
ORCK10	Green	10 kg	Ø 35 x 4.4 cm		€ 50.00
ORCK15	Yellow	15 kg	Ø 40 x 4.7 cm		€ 75.00
ORCK20	Blue	20 kg	Ø 44.5 x 5 cm		€ 100.00
ORCK25	Red	25 kg	Ø 44.5 x 9 cm		€ 125.00

OLYMPIC IRON CAST PLATES 4 GRIP 50MM

	ITEM#: OPTK Body-Solid Olympic Clron Cast Plates 4 Grip 50 mm Warranty: 6 Months			<ul style="list-style-type: none"> • Quad-grip design for safer and easier performance • Baked on hammertone black finish that is durable, chip and rust resistant • Cast from the highest quality iron 	
	Code	Colour	Weight	Dimensions	
OPTK1.25	Black	1.25 kg	Ø 17 x 1.9 cm		€ 4.75
OPTK2.50	Black	2.50 kg	Ø 19 x 2 cm		€ 10.00
OPTK5	Black	5 kg	Ø 24 x 2.5 cm		€ 20.00
OPTK10	Black	10 kg	Ø 33.5 x 3.1 cm		€ 40.00
OPTK15	Black	15 kg	Ø 38.5 x 3.8 cm		€ 60.00
OPTK20	Black	20 kg	Ø 45 x 3.8 cm		€ 80.00
OPTK25	Black	25 kg	N/A		€ 100.00

STANDARD PLATES RUBBER GRIP 25MM

	ITEM#: SRP Body-Solid Standard Rubber Plates 25 mm Warranty: 6 Months			<ul style="list-style-type: none"> • Only free weights will ensure that all major muscle groups are worked fully, thus shaping the body into proper and symmetrical proportions. Dollar for dollar, pound for pound, these plates are the best value anywhere! 	
	Code	Colour	Weight		
SRP1-25	Black	1.25 kg			€ 5.00
SRP2-50	Black	2.50 kg			€ 10.00
SRP5	Black	5 kg			€ 20.00
SRP10	Black	10 kg			€ 40.00
SRP15	Black	15 kg			€ 60.00
SRP20	Black	20 kg			€ 80.00

	OLYMPIC TRICEPS BAR	SPECIFICATIONS
	ITEM#: OB34 Weight: 10.2 kg Dimensions: L 86.4 x W 17.8 x H 7.5 cm Warranty: 6 Months	<ul style="list-style-type: none"> Designed specifically for maximum concentration of those hard to hit triceps muscles 86 cm Long For Olympic weight plates (50 mm)
OB34	Body-Solid Olympic Triceps Bar	€ 99.00

	OLYMPIC COMBO BAR	SPECIFICATIONS
	ITEM#: OB48 Weight: 9 kg Dimensions: L 122 x W 12 x H 9.5 cm Warranty: 6 Months	<ul style="list-style-type: none"> Two separate grip positions vary the isolation of the bicep and triceps muscles 121 cm Long For Olympic weight plates (50 mm)
OB48	Body-Solid Olympic Combo Bar	€ 89.00

	OLYMPIC SHRUG BAR	SPECIFICATIONS
	ITEM#: OTB50 Weight: 20.5 kg Dimensions: L 142.2 x W 62.8 x H 9.5 cm Warranty: 6 Months	<ul style="list-style-type: none"> 2.5 cm grip Knurled handles for grip Uniquely designed to eliminate contact with the upper thighs Solid steel with a chrome finish For Olympic weight plates (50 mm)
OTB50	Body-Solid Olympic Shrug Bar	€ 175.00

	OLYMPIC SHRUG BAR (RAISED HANDLES)	SPECIFICATIONS
	ITEM#: OTB50RH Weight: 22.7 kg Dimensions: L 142.2 x W 62.8 x H 9.5 cm Warranty: 6 Months	<ul style="list-style-type: none"> 25.5 Cm loadable sleeve space Knurled handles for grip Load is centered and not off axis like traditional deadlifts putting less stress on the spine Welded collar mount Made in the USA
OTB50RH	Body-Solid Olympic Shrug Bar with Raised Handles	€ 219.00

	OLYMPIC MULTI-GRIP BAR	SPECIFICATIONS
	ITEM#: OMG86 Weight: 20.4 kg Dimensions: L 219 x W 20.4 x H 7.5 cm Warranty: 6 Months	<ul style="list-style-type: none"> Three separate neutral grips More natural lifting planes Enhanced muscle recruitment 3 cm knurled handles Compatible with most power racks and Olympic plates
OMG86	Body-Solid Olympic Multi-Grip Bar	€ 275.00

	FARMERS WALK BARS (PAIR)	SPECIFICATIONS
	ITEM#: BSTFWH Weight: 7.9 kg each Dimensions: L 152.4 x W 7.5 x H 19 cm Warranty: 6 Months	<ul style="list-style-type: none"> Build strength & endurance across body Grip strength, shoulder, back, leg and core focus Knurled grip handles 11-gauge steel 15 cm long, 5 cm diameter weight sleeves Black powder-coat finish
BSTFWH	Body-Solid Farmers Walk Bars (Pair)	€ 169.00

	OLYMPIC DUMBBELL HANDLE	SPECIFICATIONS
	ITEM#: OLDH Weight: 4.5 kg Dimensions: L 51 x W 9 x H 9 cm Warranty: 6 Months	<ul style="list-style-type: none"> 2 collars included Ergonomic anti-slip handle Space for plates: 17,5 cm on each side Sold individually
OLDH	Body-Solid Olympic Dumbbell Handle	€ 65.00

 OLYMPIC EZ CURL BAR		SPECIFICATIONS
ITEM#: OLEZCB120	Weight: 7.5 kg Dimensions: L 120 cm Warranty: 6 Months	<ul style="list-style-type: none"> • Biomechanically angled dual grips allow you to avoid injury and achieve maximum gains • 120 cm long • Clips inclusive
OLEZCB120B	Body-Solid Olympic EZ Curl Bar 120 Black	€ 85.00
OLEZCB120C	Body-Solid Olympic EZ Curl Bar 120 Chrome	€ 85.00

 OLYMPIC BAR		SPECIFICATIONS
ITEM#: OLBAR150	Weight: 13.6 kg Dimensions: L 150 cm Warranty: 6 Months	<ul style="list-style-type: none"> • Precision-engineered knurling, with 30 mm diameter • 94 cm space between collars
OLBAR150B	Body-Solid Olympic Bar Black 150 cm	€ 159.00
OLBAR150C	Body-Solid Olympic Bar Chrome 150 cm	€ 159.00

 OLYMPIC BAR		SPECIFICATIONS
ITEM#: OLBAR180	Weight: 15.3 kg Dimensions: L 180 cm Warranty: 6 Months	<ul style="list-style-type: none"> • 30.7 mm grip • 117 cm space between collars • 180 cm Long • 28 cm sleeve length
OLBAR180B	Body-Solid Olympic Bar Black 180 cm	€ 159.00
OLBAR180C	Body-Solid Olympic Bar Chrome 180 cm	€ 159.00

 OLYMPIC BAR (Weight Capacity 350 kg)		SPECIFICATIONS
ITEM#: OLBAR220	Weight: 20 kg Dimensions: L 220 cm Warranty: 6 Months	<ul style="list-style-type: none"> • 30.7 mm grip • 131 cm space between collars • 39 cm sleeve length • Max. Weight Capacity 350 kg • For Olympic plates with ø50 mm
OLBAR220B	Body-Solid Olympic Bar 220 cm Black	€ 179.00
OLBAR220C	Body-Solid Olympic Bar 220 cm Chrome	€ 179.00

 OLYMPIC SUPER POWER BAR (Weight Capacity 700 kg)		SPECIFICATIONS
ITEM#: OLSPB220	Weight: 20 kg Dimensions: L 220 cm Warranty: 6 Months	<ul style="list-style-type: none"> • For Olympic plates ø 50 mm • 2 anti-slip embedded handles • Olympic Super Power Bar of 220 cm with static load up to 700 kg in chrome
OLSPB220	Body-Solid Olympic Super Power Bar 220 cm	€ 229.00

 OLYMPIC BAR NEEDLE BEARING CROSSTRaining		SPECIFICATIONS
ITEM#: OB220MA	Weight: 20 kg Dimensions: L 220 x W 5 cm Warranty: 6 Months	<ul style="list-style-type: none"> • Man's bar / 4 Bearings / Multi Knurl • Dual markings, no center knurling • Tensile strength 200.000 PSI • Alloy steel shaft, steel sleeve, needle bearing, brass bushing, spring steel clips • Weight capacity: 680 kg
OB220MA	Body-Solid Olympic Bar 50 mm Male 220 cm / 28 mm shaft	€ 339.00

	OLYMPIC BAR NEEDLE BEARING CROSSTRAINING	SPECIFICATIONS
	<p>ITEM#: OB210FEM</p> <p>Weight: 15 kg</p> <p>Dimensions: L 210 x W 5 cm</p> <p>Warranty: 6 Months</p>	<ul style="list-style-type: none"> • Women's bar / 4 Bearings / Multi Knurl • Dual markings, no center knurling • Tensile strength 200.000 PSI • Alloy steel shaft, steel sleeve, needle bearing, brass bushing, spring steel clips • Weight capacity: 545 kg
OB210FEM	Body-Solid Olympic Bar 50 mm Female 210 cm/25 mm shaft	€ 299.00

	OLYMPIC TECHNICAL BAR	SPECIFICATIONS
	<p>ITEM#: TB15</p> <p>Weight: 7.5 kg</p> <p>Dimensions: 183 cm</p> <p>Warranty: 6 Months</p>	<ul style="list-style-type: none"> • For Olympic plates ø 50 mm • 2 anti-slip embedded handles • Machine-knurl aluminum bar is 28 mm in diameter with steel sleeves to give a real bar feel at a fraction of the weight.
TB15	Body-Solid Olympic Technical Bar	€ 149.00

	OLYMPIC SPRING COLLAR (PAIR)	SPECIFICATIONS
	<p>ITEM#: OLCLIP</p> <p>Weight: 0.2 kg</p> <p>Dimensions: L 10.1 x W 10.8 x H 11.4 cm</p> <p>Warranty: 6 Months</p>	<ul style="list-style-type: none"> • Made of the highest quality spring steel possible • For Olympic style bars only • Sold individually
OLCLIP	Body-Solid Olympic Spring Collar	€ 9.90

	STANDARD BAR FOR DUMBBELL	SPECIFICATIONS
	<p>ITEM#: STDH35</p> <p>Weight: 1 kg</p> <p>Dimensions: L 35 x W 3.8 x H 3.8 cm</p> <p>Warranty: 6 Months</p>	<ul style="list-style-type: none"> • Solid steel. • Fully adjustable to accommodate any user • Standard bar for dumbbells of 35 cm (bar ø 25 mm) • For standard plates (ø 25 mm)
STDH35	Body-Solid Standard 25 mm bar for dumbbell	€ 12.00

	STANDARD 2 BAR FOR DUMBBELL	SPECIFICATIONS
	<p>ITEM#: STDH40</p> <p>Weight: 1.25 kg</p> <p>Dimensions: L 40 x W 3.8 x H 3.8 cm</p> <p>Warranty: 6 Months</p>	<ul style="list-style-type: none"> • Solid steel. • Fully adjustable to accommodate any user • Standard bar for dumbbells of 40 cm (bar ø 25 mm) • For standard plates (ø 25 mm)
STDH40	Body-Solid Standard 25 mm bar for dumbbell	€ 14.00

	STANDARD BAR 35 CM FOR DUMBBELL (THREADED)	SPECIFICATIONS
	<p>ITEM#: STDHTR35</p> <p>Weight: 1.8 kg</p> <p>Dimensions: L 35 cm</p> <p>Warranty: 6 Months</p>	<ul style="list-style-type: none"> • 35.5 cm long • Product weight: 1.80 kg each • Collars included • Sold Individually
STDHTR35	Body-Solid Standard 25 mm bar for Threaded dumbbell	€ 15.00

	STANDARD BAR 40 CM FOR DUMBBELL (THREADED)	SPECIFICATIONS
	<p>ITEM#: STDHTR40</p> <p>Weight: 1.82 kg</p> <p>Dimensions: L 40 cm</p> <p>Warranty: 6 Months</p>	<ul style="list-style-type: none"> • 40 cm long • Product weight: 1.82 kg each • Collars included • Sold Individually
STDHTR40	Body-Solid Standard 25 mm bar for Threaded dumbbell	€ 17.00

	STANDARD EZ-CURL BAR 120 CM	SPECIFICATIONS
	ITEM#: STEZCB120 Weight: 4.9 kg Dimensions: L 120 cm Warranty: 6 Months	<ul style="list-style-type: none"> Standard bar (bar Ø 25 mm) 120 cm
STEZCB120	Body-Solid Standard Bar 120 cm	€ 39.00

	STANDARD EZ-CURL BAR 120 CM (THREADED)	SPECIFICATIONS
	ITEM#: STEZCBTR Weight: 4.9 kg Dimensions: L 120 cm Warranty: 6 Months	<ul style="list-style-type: none"> Standard chrome EZ curl bar (bar Ø 25 mm) of 120 cm
STEZCBTR	Body-Solid Standard EZ-Curl Bar 120 cm Threaded	€ 49.00

	STANDARD BAR 180CM (THREADED)	SPECIFICATIONS
	ITEM#: STBARTR180 Weight: 7.3 kg Dimensions: L 180 cm Warranty: 6 Months	<ul style="list-style-type: none"> Standard threaded chrome bar, 180 cm long 2 collars included Solid steel, Ø25 mm grip Diamond knurled gripping area 122 cm inside shoulder to shoulder Weight capacity: 100 kg
STBARTR180	Body-Solid Standard Bar 180 cm	€ 45.00

	STANDARD BAR 185 CM	SPECIFICATIONS
	ITEM#: STBAR185 Weight: 8.16 kg Dimensions: L 185 cm Warranty: 6 Months	<ul style="list-style-type: none"> Standard bar (bar Ø 25 mm) of 185 cm Fits on all Olympic width benches Solid steel. 4104 Cm between collars
STBAR185	Body-Solid Standard Bar 185 cm	€ 55.00

	STANDARD BAR 210 CM	SPECIFICATIONS
	ITEM#: STBAR210 Weight: 9.7 kg Dimensions: L 210 cm Warranty: 6 Months	<ul style="list-style-type: none"> Standard bar (bar Ø 25 mm) of 210 cm 129.5 cm between inside collars Fits on all Olympic width benches Solid steel
STBAR210	Body-Solid Standard Bar 210 cm	€ 55.00

	STANDARD SPRING COLLAR (PAIR)	SPECIFICATIONS
	ITEM#: STCLIP Weight: 0.64 kg/pair Dimensions: Warranty: 6 Months	<ul style="list-style-type: none"> For Standard style bars only
STCLIP	Body-Solid Standard Spring Collar	€ 5.00

	OLYMPIC 2 LOCK JAW COLLARS	SPECIFICATIONS
	<p>ITEM#: BSTLJ02</p> <p>Weight: N/A</p> <p>Dimensions: N/A</p> <p>Warranty: 6 Months</p>	<ul style="list-style-type: none"> • Secure weight plates in place • Protect bar finish • Easy adjustments during workouts • Designed for use with all 50 mm bars • Ideal for home, commercial facilities, group and functional fitness & high schools/universities.
BSTLJ02	Body-Solid Olympic 2 Lock Jaw Collars	€ 59.00

	HEX LOCK JAW COLLARS	SPECIFICATIONS
	<p>ITEM#: BSTLJHX</p> <p>Weight: N/A</p> <p>Dimensions: N/A</p> <p>Warranty: 6 Months</p>	<ul style="list-style-type: none"> • Secure weight plates in place • Protect bar finish • Quick-locking latch ensures reliability • Slim, light and durable • Designed for use with all 50mm bars • Ideal for home, commercial facilities, groups...
BSTLJHX	Body-Solid Hex Lock Jaw Collars	€ 75.00

	OLYMPIC SPEED LOCK OLSL50	SPECIFICATIONS
	<p>ITEM#: OLSL50</p> <p>Weight: N/A</p> <p>Dimensions: N/A</p> <p>Warranty: 6 Months</p>	<ul style="list-style-type: none"> • Secure weight plates in place • Protect bar finish • Easy adjustments during workouts • Ideal for home, commercial facilities, group and functional fitness & high schools/universities.
OLSL50	Olympic Speed Lock 50 mm	€ 15.00

	DEADLIFT WEDGE	SPECIFICATIONS
	<p>ITEM#: BSTOPW</p> <p>Weight: 0.2 kg</p> <p>Dimensions: L 23 x W 4.5 x H 3 cm</p> <p>Warranty: 6 Months</p>	<ul style="list-style-type: none"> • Non-slip design / Silicone construction • Loading height: 1.3 cm • Anchor holes for optional floor mounting or storage hanging • Easy on and off plate load • Designed to handle any weight
BSTOPW	Body-Solid Tools Deadlift Wedge	€ 19.00

	OLYMPIC BAR STAND	SPECIFICATIONS
	<p>ITEM#: BSTOBS</p> <p>Weight: 3 kg</p> <p>Dimensions: L 5 x W 43 x H 30 cm</p> <p>Warranty: 6 Months</p>	<ul style="list-style-type: none"> • Ideal for dedicated deadlifting bars • Sold individually • Heavy-duty bolt-on design • 26 mm solid steel • Increase starting bar height with 25.4 cm • 38 mm minimum plate to ground clearance
BSTOBS	Body-Solid Tools Olympic Bar Stand	€ 65.00

	OLYMPIC BAR JACK	SPECIFICATIONS
	<p>ITEM#: BSTOBJ</p> <p>Weight: 4 kg</p> <p>Dimensions: L 50 x W 11.5 x H 32 cm</p> <p>Warranty: 6 Months</p>	<ul style="list-style-type: none"> • Elevate Olympic bars for easy plate load • Ideal for use with deadlifts & other floor-starting lifts • 11-gauge steel construction • Heavy-duty plastic coating
BSTOBJ	Body-Solid Tools Olympic Bar Jack	€ 75.00

	OLYMPIC ADAPTER SLEEVE 20 CM	SPECIFICATIONS
	<p>ITEM#: OAS8</p> <p>Weight: 0.3 kg</p> <p>Dimensions: L 20.3 x W 5 x H 5 cm</p> <p>Warranty: 6 Months</p>	<ul style="list-style-type: none"> • Converts 25 mm standard plate posts to 50 mm Olympic posts • 20 Long • Heavy-duty nylon with hex bolt lock-down for long lasting performance
OAS8	Body-Solid Adapter Sleeve 20 cm	€ 12.00

	OLYMPIC ADAPTER SLEEVE 35 CM	SPECIFICATIONS
	ITEM#: OAS14 Weight: 0.4 kg Dimensions: L 35.6 x W 5 x H 5 cm Warranty: 6 Months	<ul style="list-style-type: none"> • Converts 25 mm standard plate posts to 50 mm Olympic posts • 35 Long • Heavy-duty nylon with hex bolt lock-down for long lasting performance
OAS14	Body-Solid Adapter Sleeve 35 cm	€ 20.00

	WEIGHT STACK ADAPTER PLATE 1.13 KG	SPECIFICATIONS
	ITEM#: WSA2.5 Weight: 1.1 kg Dimensions: L 10 x W 12.7 x H 3.8 cm Warranty: 6 Months	<ul style="list-style-type: none"> • For use on selectorized weight stacks • Allows you to increase resistance in smaller increments • Features thick, protective rubber molded over a cast iron core
WSA2.5	Body-Solid Weight Stack Adapter Plate 1.13 kg	€ 26.00

	WEIGHT STACK ADAPTER PLATE 2.27 KG	SPECIFICATIONS
	ITEM#: WSA5 Weight: 2.3 kg Dimensions: L 10 x W 12.7 x H 5.7 cm Warranty: 6 Months	<ul style="list-style-type: none"> • For use on selectorized weight stacks • Allows you to increase resistance in smaller increments • Features thick, protective rubber molded over a cast iron core
WSA5	Body-Solid Weight Stack Adapter Plate 2.27	€ 29.00

STRENGTH BODYTRADING



DUMBBELLS

BodyTrading



CHROME DUMBBELLS PER PAIR					
	ITEM#: CHDU Bodytrading Chrome Dumbbells CHDU			<ul style="list-style-type: none"> • Anti-slip grip • Available from 1 to 10kg • Color: chrome • Sold per pair 	
	Warranty: 6 Months				
Code	Weight				
CHDU1	1 kg				€ 12.00
CHDU2	2 kg				€ 24.00
CHDU3	3 kg				€ 36.00
CHDU4	4 kg				€ 48.00
CHDU5	5 kg				€ 60.00
CHDU6	6 kg				€ 72.00
CHDU7	7 kg				€ 84.00
CHDU8	8 kg				€ 96.00
CHDU9	9 kg				€ 108.00
CHDU10	10 kg				€ 120.00
CHDU1-10	Set 1-10 kg/10 pair	No Rack			€ 660.00
CHDUSET	Set 1-10 kg/10 pair	Rack Included			€ 895.00

KETTLEBELLS

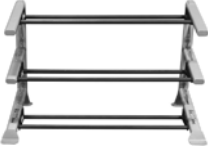

POWDER COATED KETTLEBELLS					
	ITEM#: KBPO Bodytrading Powder Coated Kettlebells			<ul style="list-style-type: none"> • Color-coded rings on the handles for easy identification • Machined wide flat base provides a solid foundation for floor work • Matte powder coat finish for the ideal feel and grip – no ugly cracks or chipping • Available weights: 4/6/8/10/12/16/20/24/28/32/36/40/48 kg 	
	Warranty: 6 Months				
Code	Weight	Colour			
KBPO4	4 kg	Light Green			€ 19,00
KBPO6	6 kg	Royal Blue			€ 28,00
KBPO8	8 kg	Pink			€ 37,00
KBPO10	10 kg	Light Blue			€ 47,00
KBPO12	12 kg	blue			€ 57,00
KBPO16	16 kg	Yellow			€ 75,00
KBPO20	20 kg	Purple			€ 93,00
KBPO24	24 kg	Green			€ 112,00
KBPO28	28 kg	Orange			€ 132,00
KBPO32	32 kg	Red			€ 149,00
KBPO36	36 kg	Grey			€ 168,00
KBPO40	40 kg	White			€ 185,00
KBPO48	48 kg	Gold			€ 225,00

PRO CLUBLINE KETTLEBELL RACK			SPECIFICATIONS		
	ITEM#: SDKR500KB			SDKR500KB includes:	
	Weight:	64.4 kg		<ul style="list-style-type: none"> • 2-SDKRUP2 2-Tier Uprights • 2-SDKRKB Kettlebell Shelves 	
	Dimensions:	L 177.5 x W 75 x H 68.8 cm			
	Warranty:	Full Commercial (P. 119)			
SDKR500KB	Pro Clubline Kettlebell Rack			€ 850.00	

COMPETITION KETTLEBELLS					
	ITEM#: KBCO Bodytrading Competition Kettlebells Warranty: 6 Months			<ul style="list-style-type: none"> • A professional grade competition kettlebell • 100% steel construction • Color-coded for easy identification between sizes • Weight stamped into Kettlebell • Bare metal handles that are ready for chalking! • Regulation 33 mm Handle • Sold per piece • For professional use 	
	Code	Weight	Colour		
KBC04	4 kg	Pale Green		€ 75,00	
KBC06	6 kg	Mint Green		€ 75,00	
KBC08	8 kg	Pink		€ 60,00	
KBC010	10 kg	Light Blue		€ 70,00	
KBC012	12 kg	Blue		€ 80,00	
KBC014	14 kg	Light Yellow		€ 85,00	
KBC016	16 kg	Yellow		€ 95,00	
KBC018	18 kg	Light Purple		€ 107,00	
KBC020	20 kg	Purple		€ 120,00	
KBC022	22 kg	Light Green		€ 132,00	
KBC024	24 kg	Green		€ 144,00	
KBC026	26 kg	Black		€ 156,00	
KBC028	28 kg	Orange		€ 168,00	
KBC030	30 kg	Light Red		€ 180,00	
KBC032	32 kg	Red		€ 192,00	
KBC036	36 kg	Grey		€ 214,00	
KBC040	40 kg	White		€ 240,00	
KBC044	44 kg	Silver		€ 335,00	
KBC048	48 kg	Golden		€ 410,00	

	PRO CLUBLINE KETTLEBELL RACK		SPECIFICATIONS	
	ITEM#: SDKR1000KB Weight: 99.8 kg Dimensions: L 177.5 x W 82.6 x H 109.5 cm Warranty: Full Commercial (P. 119)			SDKR1000KB includes: <ul style="list-style-type: none"> • 2-SDKRUP2 2-Tier Uprights • 2-SDKRKB Kettlebell Shelves
SDKR1000KB	Pro Clubline Kettlebell Rack			€ 1230.00

	RACK FOR 6 KETTLEBELLS		SPECIFICATIONS	
	ITEM#: GDKR50 Weight: 8.5 kg Dimensions: L 48.2 x W 50.8 x H 53.3 cm Warranty: In-Home Lifetime (P. 119)		<ul style="list-style-type: none"> • Stores 6 total Kettlebells, any size • 3 offset tiers for easy access • Modern Design • Compact, Stable and Affordable 	
GDKR50	Body-Solid Kettlebell Rack	Kettlebells not included	€ 145.00	

	DUMBBELL / KETTLEBELL RACK		SPECIFICATIONS	
	ITEM#: GDKR100 Weight: 36 kg Dimensions: L 113 x W 58.4 x H 83.8 cm Warranty: In-Home Lifetime / Light Commercial (P. 119)			<ul style="list-style-type: none"> • Holds dumbbells, kettle bells, or both • Reversible tiers provide versatility • Kettlebell side can hold accessories as well • Dumbbell side can be angled for easy access
GDKR100	Body-Solid 2 Tier Dumbbell / Kettlebell Rack			€ 315.00

	HIP THRUSTER/FLOOR GLUTE HAM DEVELOPER		SPECIFICATIONS	
	ITEM#: HIPTR Weight: 14.5 kg Dimensions: L 35.5 x W 82.5 x H 57.5 cm Warranty: Frame: 10 years - Parts: 6 months		<ul style="list-style-type: none"> • Height-adjustable hip thrust pad • Adjustable footrest • Large, adjustable and removable knee pad • 8 band pins on each side for resistance bands • Stable, heavy-duty and freestanding design • Safe and easy to use • Suitable for users of all body sizes 	
HIPTR	Bodytrading Hip thruster/Floor Glute Ham Developer			€ 895.00

MINI EXERCISE BANDS				
	ITEM#: MIBA Bodytrading Mini Exercise Bands Warranty: 6 Months			<ul style="list-style-type: none"> • Ideal for floor-based lower-body exercises • Strengthen and tone arms, legs, hips and glutes • Great for therapeutic exercise and strength training • Secures comfortably to ankles, calves, knees or thighs • Flat band loop • Available in 4 color-coded resistances
	Code	Resistance	Colour	
MIBA1	Very light	Red		€ 6.00
MIBA2	Light	Yellow		€ 7.00
MIBA3	Medium	Green		€ 8.00
MIBA4	Heavy	Blue		€ 9.00

SUPER RESISTANCE BANDS				
	ITEM#: BTSRB Bodytrading Super Resistance Bands Warranty: 6 Months			<ul style="list-style-type: none"> • Latex elastic bands, ideal for strength training • Lightweight and portable • 6 levels of resistance • Many exercises can be done with these bands
	Code	Resistance	Colour	
BTSRB1	Very light	Yellow		€ 10.00
BTSRB2	Light	Orange		€ 15.00
BTSRB3	Medium	Red		€ 20.00
BTSRB4	Heavy	Blue		€ 25.00
BTSRB5	Very heavy	Red		€ 30.00
BTSRB6	Extreme heavy	Blue		€ 39.00

PULL EXPANDER				
	ITEM#: BTPE Bodytrading Pull Expander Warranty: 6 Months			<ul style="list-style-type: none"> • Rotating foam handles • 3 different cable resistances • Handle length: 13 cm • Ideal for private use
	Code	Resistance	Colour	
BTPE1	Light	Red		€ 12.00
BTPE2	Medium	Grey		€ 12.00
BTPE3	Heavy	Black		€ 12.00

	MASSAGE FOAM ROLLER	SPECIFICATIONS
	<p>ITEM#: MFR</p> <p>Weight: 0.65 kg</p> <p>Dimensions: L 33 x Ø15 cm</p> <p>Warranty: 6 Months</p>	<ul style="list-style-type: none"> • The solid core is made of a resilient grade of high density EVA foam • Specially bumps that are firm but flexible • Material ABS (pipe), EVA (cover) • Hardness: 35-40° • Colour: grey
MFR	Bodytrading Massage Foam Roller	€ 29.00

	SOFT PLYO BOX SET	SPECIFICATIONS
	<p>ITEM#: PSBSET</p> <p>Weight: -</p> <p>Dimensions: L 90 x L 73 x H 15 to 60 cm</p> <p>Warranty: 6 Months</p>	<ul style="list-style-type: none"> • High quality EPE foam & durable PVC cover • Very sturdy and safe • Easy maintenance • Non-slip bottom • Adjustable height • Velcro straps to connect the boxes to each other • Available as a set of 4 boxes
PSBSET	Bodytrading Soft Plyo Box Set	€ 795.00

	BALANCE BALL	SPECIFICATIONS
	<p>ITEM#: BALBALL</p> <p>Weight: 6.3 kg</p> <p>Dimensions: L 59 x W 59 x H 21 (bloated) cm</p> <p>Warranty: 6 Months</p>	<ul style="list-style-type: none"> • Sculpt abs • Strengthen arms • Tone legs
BALBALL	Bodytrading Balance Ball	€ 115.00

	SUSPENSION TRAINER	SPECIFICATIONS
	<p>ITEM#: MGT100</p> <p>Weight: 1.42 kg</p> <p>Dimensions: L 500 cm</p> <p>Warranty: 6 Months</p>	<ul style="list-style-type: none"> • Durable nylon fabric and metal parts • Slip-resistant stabilizer ring and grip handles • Two suspension straps + extender strap + door anchor + travel carry bag • Over 300 body weight exercises • Maximum load: 150 kg
MGT100	Bodytrading Multi Gym Trainer	€ 69.00

	CHIN UP BAR TRI-STAND	SPECIFICATIONS
	<p>ITEM#: CU100</p> <p>Weight: 21 kg</p> <p>Dimensions: L 130 x W 58 x H 60 cm</p> <p>Warranty: 6 Months</p>	<ul style="list-style-type: none"> • Suitable for wall mounting • Solid 28 mm steel pipes • Suitable for numerous exercises thanks to the multi-grip • Carries up to 350 kg! • No plastic parts, will not break!
CU100	Bodytrading Chin Up Bar Tri-Stand	€ 149.00

	AEROBIC STEP	SPECIFICATIONS
	<p>ITEM#: ST100</p> <p>Weight: 10 kg</p> <p>Dimensions: L 110 x W 38 x H 15-25 cm</p> <p>Warranty: 6 Months</p>	<ul style="list-style-type: none"> • Wide spread for maximum stability • Cover strengthened, anti-slip and ridged for a better shock absorption • Good dimensions for dance moves • Adaptable height: 15 - 20 - 25 cm • With guidebook (& pictures) of 16 pages
ST100	Bodytrading Aerobic Step	€ 99.00

	DIGITAL LED INTERVAL TRAINING TIMER	SPECIFICATIONS
	<p>ITEM#: DT0100</p> <p>Weight: 10 kg</p> <p>Dimensions: L 64 x W 5 x H 16 cm</p> <p>Warranty: 6 Months</p>	<ul style="list-style-type: none"> • Colour digits: blue and red • Clock function 12/24 hours • Count up/down (0:00 to 99:59) - can be customized • One programmable interval, self-adjustable • Loud beeps / visible number of rounds • Operation by remote control
DT0100	Bodytrading Digital LED Interval Training Timer	€ 269.00

PRO NYLON STIRRUP HANDLE UNIT		SPECIFICATIONS
	ITEM#: NSH100	<ul style="list-style-type: none"> D-Rings, Pull all your cable workouts together Comfortable Grip Handle Ideal for all your lifting and pulling exercises High quality nylon Easy-adjust steel D-rings for quick changes
	Weight: 0.27 kg Dimensions: L 17 x W 13 x H 5 cm Warranty: 6 Months	
NSH100	Bodytrading Pro Nylon Stirrup Handle Unit	€ 39.00

COMFORT LEATHER BELT BLACK S/M/L/XL		SPECIFICATIONS
	ITEM#: BE105	<ul style="list-style-type: none"> Quality padding for back support and comfort Double buckle with heavy steel roller Double stitched edges Built-in foam lumbar pad Excellent back and abdominal support Color: black
	Weight: 1 kg Warranty: 6 Months	
BE105XS	Bodytrading Comfort Leather Belt Extra Small Black	€ 19.00
BE105S	Bodytrading Comfort Leather Belt Small Black	€ 19.00
BE105M	Bodytrading Comfort Leather Belt Medium Black	€ 19.00
BE105L	Bodytrading Comfort Leather Belt Large Black	€ 19.00
BE105XL	Bodytrading Comfort Leather Belt Extra Large Black	€ 19.00

LEATHER DIPPING BELT NATURAL		SPECIFICATIONS
	ITEM#: BE190NAOS	<ul style="list-style-type: none"> Full cowhide leather Extra wide padded back for more comfort Superior saddle stitching Heavy duty metal chain One size
	Weight: 1 kg Dimensions: L 104 x W 11 x H 1 cm Warranty: 6 Months	
BE190NAOS	Bodytrading Leather Dipping Belt Natural One size	€ 39.00

PRO WRISTSTRAP GLOVES S/M/L/XL		SPECIFICATIONS
	ITEM#: GL125	<ul style="list-style-type: none"> Supreme double stitching with Easy removal fins Highest quality extra thick top grain leather Padded double layered leather fingers and palm Heavy duty Lycra® finger and back panels Fully adjustable 5 cm neoprene wrist wrap with double Velcro® closure
	Weight: 0.11 kg Dimensions: L 27 x W 15 x H 5 cm Warranty: 6 Months	
GL125S	Bodytrading Pro Wrist Wrap Grip Small	€ 15.00
GL125M	Bodytrading Pro Wrist Wrap Grip Medium	€ 15.00
GL125L	Bodytrading Pro Wrist Wrap Grip Large	€ 15.00
GL125XL	Bodytrading Pro Wrist Wrap Grip Extra Large	€ 15.00

FITNESS MAT		SPECIFICATIONS
	ITEM#: MA110	<ul style="list-style-type: none"> High quality material Anti-slip and shock absorbing Ideal for fitness training at home or at the gym Colour : blue
	Weight: 1.9 kg Dimensions: L 183 x W 61 x H 1.5 cm Warranty: 6 Months	
MA110BL	Bodytrading Fitness Mat Blue	€ 32.00
MA110GR	Bodytrading Fitness Mat Grey	€ 32.00
MA110R	Bodytrading Fitness Mat Red	€ 32.00
MA110B	Bodytrading Fitness Mat Black	€ 32.00

	<p>SILICON LUBRICANT</p> <p>ITEM#: LB</p> <p>Warranty: 6 Months</p>	<p>PACKAGE INCLUDES</p> <ul style="list-style-type: none"> • 100% silicone? for any brand treadmill that does not use oil-based lubricant • Contains no harmful solvents, petroleum distillates or aerosols • Colourless, odorless, non-toxic and non-flammable
	<p>LB100 Bodytrading Silicon Lubricant 100 ml</p>	<p>€ 15.00</p>
	<p>LB250 Bodytrading Silicon Lubricant 250 ml</p>	<p>€ 20.00</p>

	<p>DESINFECTANT</p> <p>ITEM#: MDE200</p> <p>Weight: 0.75 kg</p> <p>Warranty: 6 Months</p>	<p>PACKAGE INCLUDES</p> <ul style="list-style-type: none"> • Multicleaner • Disinfectant • Silicon Lubricant • Cleaning cloth
	<p>MDE200 Bodytrading Disinfectant</p>	<p>€ 20.00</p>

	<p>MULTI CLEANER</p> <p>ITEM#: MCL200</p> <p>Weight: 0.75 kg</p> <p>Dimensions: L 0 x W 0 x H 0 cm</p> <p>Warranty: 6 Months</p>	<p>PACKAGE INCLUDES</p> <ul style="list-style-type: none"> • Ready-to-use all purpose cleaner • Ideally suitable for all kinds of soiling on all water resistant, smooth and shiny surfaces
	<p>MCL200 Bodytrading Multi Cleaner</p>	<p>€ 15.00</p>

	<p>MAINTENANCE SET</p> <p>ITEM#: MKIT100</p> <p>Weight: 0kg</p> <p>Dimensions: L 0 x W 0 x H 0 cm</p> <p>Warranty: 6 Months</p>	<p>PACKAGE INCLUDES</p> <ul style="list-style-type: none"> • Multicleaner • Disinfectant • Silicon Lubricant • Cleaning cloth
	<p>MKIT100 Bodytrading Maintenance Set</p>	<p>€ 49.00</p>

	POWERBLOCK DUMBBELLS SPORT 24	SPECIFICATIONS
	ITEM#: PBSP24 Weight: 23.6 kg Packaging dim: 2 x (L 20 x W 20 x H 33 cm) Warranty: Weight Block: 5 years - Parts: 2 years	<ul style="list-style-type: none"> • Equals/replaces 8 pairs of dumbbells or 98 kg of free weights in 1.3 kg increments • Sold as 1 pair • Weight range: 1.3 - 10.8 kg per hand • NOT EXPANDABLE
PBSP24	Powerblock Dumbbells Sport 24	€ 239.00

	POWERBLOCK DUMBBELLS SPORT 50	SPECIFICATIONS
	ITEM#: PBSP50 Weight: 47 kg Packaging dim: 2 x (L 25 x W 25 x H 41 cm) Warranty: Weight Block: 5 years - Parts: 2 years	<ul style="list-style-type: none"> • Equals/replaces 10 pairs of dumbbells or 245 kg of free weights in 2.2 kg increments • Sold as 1 pair • Weight range: 4.5 - 22.7 kg per hand • NOT EXPANDABLE
PBSP50	Powerblock Dumbbells Sport 50	€ 475.00

	POWERBLOCK SPORT EXPANSION 5-50	SPECIFICATIONS
	ITEM#: PBSPSET1 Weight: 47 kg Packaging dim: 2 x (L 25 x W 25 x H 41 cm) Warranty: Weight Block: 5 years - Parts: 2 years	<ul style="list-style-type: none"> • Equals/replaces 16 pairs of dumbbells or 374 kg of free weights in 1.1 kg increments • Sold as 1 pair • Weight range: 2.2 - 22.7 kg per hand • EXPANDABLE to 31.7 kg (set 2) and again to 40.8 kg (set3) per hand
PBSPSET1	Powerblock Sport Expansion 5-50	€ 475.00

	POWERBLOCK SPORT EXPANSION 5-70	SPECIFICATIONS
	ITEM#: PBSPSET2 Weight: 68 kg Packaging dim: 2 x (L 25 x W 25 x H 48 cm) Warranty: Weight Block: 5 years - Parts: 2 years	<ul style="list-style-type: none"> • Equals/replaces 22 pairs of dumbbells or 714.5 kg of free weights in 1.1 kg increments • Sold as 1 pair • Weight range: 2.2 - 31.7 kg per hand • EXPANDABLE to 40.8 kg (set3) per hand
PBSPSET2	Powerblock Sport Expansion 5-70	€ 670.00

	POWERBLOCK SPORT EXPANSION 5-90	SPECIFICATIONS
	ITEM#: PBSPSET3 Weight: 89 kg Packaging dim: 2 x (L 25 x W 25 x H 48 cm) Warranty: Weight Block: 5 years - Parts: 2 years	<ul style="list-style-type: none"> • Equals/replaces 28 pairs of dumbbells or 1163.5 kg of free weights in 1.1 kg increments • Sold as 1 pair • Weight range: 2.2 - 40.8 kg per hand • NOT EXPANDABLE
PBSPSET3	Powerblock Sport Expansion 5-90	865.00

	POWERBLOCK SPORT EXPANSION STAGE 2	SPECIFICATIONS
	ITEM#: PBSPEXP2 Weight: Packaging dim: L 25 x W 25 x H 48 cm Warranty: Weight Block: 5 years - Parts: 2 years	
PBSPEXP2	Powerblock Sport Expansion Stage 2 from 5 to 70 kg	€ 195.00

	POWERBLOCK SPORT EXPANSION STAGE 3	SPECIFICATIONS
	ITEM#: PBSPEXP3 Weight: Packaging dim: L 25 x W 25 x H 48 cm Warranty: Weight Block: 5 years - Parts: 2 years	
PBSPEXP3	Powerblock Sport Expansion Stage 3 from 5 to 90 kg	€ 195.00

	POWERBLOCK DUMBBELLS PRO 32	SPECIFICATIONS
	ITEM#: PBPRO32 Weight: 30 kg Packaging dim: 2 x (L 20 x W 20 x H 41 cm) Warranty: Weight Block: 5 years - Parts: 2 years	<ul style="list-style-type: none"> • Equals/replaces 8 pairs of dumbbells or 130.6 kg of free weights in 1.8 kg increments • Sold as 1 pair • Weight range: 1.8 - 14.5 kg per hand • NOT EXPANDABLE
PBPRO32	Powerblock Dumbbells Pro 32	€ 475.00

	POWERBLOCK DUMBBELLS PRO 32	SPECIFICATIONS
	ITEM#: PBPRO50 Weight: 46 kg Packaging dim: 2 x (L 25 x W 28 x H 41 cm) Warranty: Weight Block: 5 years - Parts: 2 years	<ul style="list-style-type: none"> • Equals/replaces 20 pairs of dumbbells or 476.3 kg of free weights in 11 kg increments • Sold as 1 pair • Weight range: 1.1 - 22.7 kg per hand • NOT EXPANDABLE
PBPRO50	Powerblock Dumbbells Pro 50	€ 650.00

	POWERBLOCK DUMBBELLS EXPANSION 5-50	SPECIFICATIONS
	ITEM#: PBPROSET1 Weight: 47 kg Packaging dim: 2 x (L 25 x W 28 x H 41 cm) Warranty: Weight Block: 5 years - Parts: 2 years	<ul style="list-style-type: none"> • Equals/replaces 16 pairs of dumbbells or 374 kg of free weights • Sold as 1 pair • Weight range: 2.2 - 22.7 kg per hand • EXPANDABLE to 31.7 kg (set 2) and again to 40.8 kg (set3) per hand
PBPROSET1	Powerblock Dumbbells Pro Expansion 5-50	€ 650.00

	POWERBLOCK DUMBBELLS EXPANSION 5-70	SPECIFICATIONS
	ITEM#: PBPROSET2 Weight: 68 kg Packaging dim: 2 x (L 25 x W 25 x H 48 cm) Warranty: Weight Block: 5 years - Parts: 2 years	<ul style="list-style-type: none"> • Equals/replaces 22 pairs of dumbbells or 714.5 kg of free weights • Sold as 1 pair • Weight range: 2.2 - 31.7 kg per hand • EXPANDABLE to 40.8 kg (set3) per hand
PBPROSET2	Powerblock Dumbbells Pro Expansion 5-70	€ 870.00

	POWERBLOCK DUMBBELLS EXPANSION 5-90	SPECIFICATIONS
	ITEM#: PBPROSET3 Weight: 89 kg Packaging dim: 2 x (L 25 x W 25 x H 58 cm) Warranty: Weight Block: 5 years - Parts: 2 years	<ul style="list-style-type: none"> • Equals/replaces 28 pairs of dumbbells or 1163.5 kg of free weights • Sold as 1 pair • Weight range: 2.2 - 40.8 kg per hand • EXPANDABLE to 40.8 kg (set3) per hand
PBPROSET3	Powerblock Dumbbells Pro Expansion 5-90	€ 1090.00

	POWERBLOCK PRO EXPANSION STAGE 2	SPECIFICATIONS
	ITEM#: PBPROEXP2 Weight: Packaging dim: L 25 x W 25 x H 48 cm Warranty: Weight Block: 5 years - Parts: 2 years	
PBPROEXP2	Powerblock Pro Expansion Stage 2 from 5 to 70 kg	€ 220.00

	POWERBLOCK PRO EXPANSION STAGE 3	SPECIFICATIONS
	ITEM#: PBPROEXP3 Weight: Packaging dim: L 25 x W 25 x H 48 cm Warranty: Weight Block: 5 years - Parts: 2 years	
PBPROEXP3	Powerblock Pro Expansion Stage 3 from 5 to 90 kg	€ 220.00

	POWERBLOCK DUMBBELLS PRO 32COMMERCIAL	SPECIFICATIONS
	ITEM#: PBPRO32 Weight: 30 kg Packaging dim: 2 x (L 20 x W 20 x H 41 cm) Warranty: Weight Block: 5 years - Parts: 2 years	<ul style="list-style-type: none"> • Equals/replaces 8 pairs of dumbbells or 130.6 kg of free weights in 1.8 kg increments • Sold as 1 pair • Weight range: 1.8 - 14.5 kg per hand • NOT EXPANDABLE
PBPRO32	Powerblock Dumbbells Pro 32	€ 475.00

	POWERBLOCK 50 COMMERCIAL WITH STAND	SPECIFICATIONS
	ITEM#: PBCOM50 Weight: 113.5 kg Dimensions: Footprint on stand : 54.6 x 63.5 cm Warranty: Weight Block: 5 years - Parts: 2 years	<ul style="list-style-type: none"> • Urethane coated steel plates & Zytel pin (Pro 50/90) • Stainless steel hardware • Stand & knurled steel grip included • 4.5 kg – 22.5 kg per hand in 2.25 kg increments • Replaces 9 pairs of dumbbells or 245 kg of free weights in the space of 1 pair • NOT EXPANDABLE
PBCOM50	Powerblock Pro 50 Commercial with stand	€ 1295.00

	POWERBLOCK 90 COMMERCIAL WITH STAND	SPECIFICATIONS
	ITEM#: PBCOM90 Weight: 159 kg Dimensions: Footprint on stand : 54.6 x 63.5 cm Warranty: Weight Block: 5 years - Parts: 2 years	<ul style="list-style-type: none"> • Urethane coated steel plates & Zytel pin (Pro 50/90) • Stainless steel hardware • Stand & knurled steel grip included • 2.25-41 kg per hand in 2.25 kg increments • Replaces 18 pairs of dumbbells or 775 kg of free weights in the space of 1 pair • NOT EXPANDABLE
PBCOM90	Powerblock Pro 90 Commercial with stand	€ 1995.00

	POWERBLOCK TRAINING PACK 1	SPECIFICATIONS
	ITEM#: PBPACK1 Weight: Dimensions: Warranty: Weight Block: 5 years - Parts: 2 years	This pack includes: • Powerblock Sport 50 (PBSP50) • Sport training bench (PBBESP)
PBPACK1	Powerblock Training Pack 1	€ 795.00

	POWERBLOCK TRAINING PACK 2	SPECIFICATIONS
	ITEM#: PBPACK2 Weight: Dimensions: Warranty: Weight Block: 5 years - Parts: 2 years	This pack includes: • Powerblock Sport 24 (PBSP24) • Travel Training Bench (PBBETR)
PBPACK2	Powerblock Training Pack 2	€ 415.00

	POWERBLOCK TRAINING PACK 3	SPECIFICATIONS
	ITEM#: PBPACK3 Weight: Dimensions: Warranty: Weight Block: 5 years - Parts: 2 years	This pack includes: • Powerblock Sport EXP set 5-50 (PBSPSET1) • Sport training bench (PBBESP)
PBPACK3	Powerblock Training Pack 3	€ 795.00

	POWERBLOCK TRAINING PACK 4	SPECIFICATIONS
	ITEM#: PBPACK4 Weight: Dimensions: Warranty: Weight Block: 5 years - Parts: 2 years	This pack includes: • Powerblock Sport EXP set 5-70 (PBSPSET2) • Sport training bench (PBBESP)
PBPACK4	Powerblock Training Pack 4	€ 950.00

	POWERBLOCK TRAINING PACK 5	SPECIFICATIONS
	ITEM#: PBPACK5 Weight: Dimensions: Warranty: Weight Block: 5 years - Parts: 2 years	This pack includes: • Powerblock Sport EXP set 5-90 (PBSPSET3) • Sport training bench (PBBESP)
PBPACK5	Powerblock Training Pack 5	€ 1150.00

STANDS

	POWERBLOCK SMALL COMPACT STAND	SPECIFICATIONS
	ITEM#: PBSTSMCO Weight: Dimensions: L 49.5 x W 45.7 x H 63.5 cm Warranty: Frame: 5 years	<ul style="list-style-type: none"> The Compact Stand will fold easily for storage or portability. The stand will work with any PowerBlock set up to 22.7 kg per hand. No assembly is required.
PBSTSMCO	Powerblock Small Compact Stand	€ 85.00

	POWERBLOCK LARGE COMPACT STAND	SPECIFICATIONS
	ITEM#: PBSTLCO Weight: Dimensions: L 50.8 x W 45.7 x H 66 cm Warranty: Frame: 5 years	<ul style="list-style-type: none"> The Large Compact Stand folds easily for storage or portability. The stand will work with any PowerBlock set up to 40.8 kg per hand.
PBSTLCO	Powerblock Large Compact Stand	€ 95.00

	POWERBLOCK POWER STAND	SPECIFICATIONS
	ITEM#: PBSTPOW Weight: Dimensions: L 71 x W 45.7 x H 122 cm Warranty: Frame: 5 years	<ul style="list-style-type: none"> This stand is best for use with PowerBlock Sport 24, Pro 32, Sport 50 or PowerBlock 50 sets. Split design allows user to "step in" to get closer to weights.
PBSTPOW	Powerblock Power Stand	€ 160.00

	POWERBLOCK RACK STAND	SPECIFICATIONS
	ITEM#: PBSTU125R Weight: Dimensions: L 48.2 x W 53.3 x H 72.4 cm Warranty: Frame: 5 years	<ul style="list-style-type: none"> This stand will work for any set up to 56.7 kg per hand. This stand is pretty much "bullet proof" with all steel construction.
PBSTU125R	Powerblock Rack Stand	€ 275.00

	POWERBLOCK POWERSTAND MAX - 90 LB	SPECIFICATIONS
	ITEM#: PBSTPOWMAX Weight: Dimensions: L 46 x W 71 x H 56 cm Warranty: Frame: 5 years	<ul style="list-style-type: none"> Specifically intended for racking PowerBlock Dumbbell sets (up to 22.5 kg) Steel construction Black texture powder coat finish Assembly required
PBSTPOWMAX	Powerblock Power Stand Max	€ 199.00

ACCESSORIES

	POWERBLOCK ADJUSTABLE KETTLEBELL	SPECIFICATIONS
	ITEM#: PBKB Weight: N/A Dimensions: L 14.6 x W 10.8 x H 25.4 cm Warranty: Weight Block: 5 years - Parts: 2 years	<ul style="list-style-type: none"> Replaces 4 kettlebells in the space of one Adjustable weight increments: 8-10-12-16 kg Contoured shell provides exceptional comfort Cast iron construction with black powdercoating Steel selector pin with magnetic lock Weights printed in pounds and kilograms Portable for travel
PBKB	Powerblock adjustable kettlebell	€ 199.00

	POWERBLOCK KETTLEBLOCK HANDLE	SPECIFICATIONS
	ITEM#: PBKH Weight: 4.5 kg Dimensions: L 21.6 x W 16 x H 33 cm Warranty: Weight Block: 5 years - Parts: 2 years	<ul style="list-style-type: none"> Robust and compact Change weight quickly Space saving Easy to take with you Cost efficient Easy to use
PBKH	Powerblock KettleBlock handle	€ 129.00

	POWERBLOCK PRO STRAIGHT BAR	SPECIFICATIONS
	ITEM#: PBSB Weight: N/A Dimensions: Length bar: 104 cm Warranty: Weight Block: 5 years - Parts: 2 years	<ul style="list-style-type: none"> • 28 mm knurled bar • Weight chart on top of handle • Compatible with Pro 50 and Pro EXP (Pro Series) & U50, U70, U90 (Urethane Series) • Not Compatible with Elite/Classic & Sport Series
PBPROSB	Powerblock Pro straight bar	€ 185.00

	POWERBLOCK PRO EZ CURL BAR	SPECIFICATIONS
	ITEM#: PBEZB Weight: N/A Dimensions: Length bar: 83 cm Warranty: Weight Block: 5 years - Parts: 2 years	<ul style="list-style-type: none"> • 25 mm knurled bar • Weight chart on top of handle • Compatible with Pro 50 and Pro EXP (Pro Series) & U50, U70, U90 (Urethane Series) • Not Compatible with Elite/Classic & Sport Series
PBPROEZCB	Powerblock Pro EZ curl bar	€ 185.00

	POWERBLOCK SPORT BENCH	SPECIFICATIONS
	ITEM#: PBBESP Weight: Dimensions: L127 x W 53.3 x H 40.6 cm (flat position) Warranty: Frame: 5 years	<ul style="list-style-type: none"> • 5 position adjustable bench • Bench positions: flat to 30, 45, 60 ° and also military position • Built in wheel and handle kit • 250 kg weight capacity
PBBESP	Powerblock Sport Bench	€ 325.00

	CHIN ATTACHMENT FOR SPORT BENCH	SPECIFICATIONS
	ITEM#: PBBESPCA Weight: Dimensions: W 122 x H 209.5 cm Warranty: Frame: 5 years	<ul style="list-style-type: none"> • SportBench frame decal indicates chin-up positioning • Foam grips for added comfort • 28.5 mm grip diameter • Assembly Required • 110 kg weight capacity
PBBESPCA	Powerblock Chin Attachment for Sport Bench	€ 109.00

	DIP ATTACHMENT FOR SPORT BENCH	SPECIFICATIONS
	ITEM#: PBBESPDA Weight: Dimensions: W 57 x H 120.6 cm Warranty: Frame: 5 years	<ul style="list-style-type: none"> • Correct Dip positioning • Foam grips for comfort • 34.95 mm grip diameter • Tension knob to secure dip station attachment • Assembly required / Ships in 1 package • 110 kg weight capacity
PBBESPDA	Powerblock Dip Attachment for Sport Bench	€ 89.00

	POWERBLOCK TRAVEL BENCH	SPECIFICATIONS
	ITEM#: PBBETR Weight: Dimensions: 101.6 x W 24 x H 38.1 cm (upright flat position) Warranty: Frame: 5 years	<ul style="list-style-type: none"> • Fold up bench allows for easy storage • Built-in handle which allows the bench to be easily carried • 250 kg weight capacity
PBBETR	Powerblock Travel Bench	€ 189.00

	POWERBLOCK POWER BENCH PRO	SPECIFICATIONS
	ITEM#: PBPB Weight: 30.8 kg Dimensions: L 134.6 x W 54.6 x H 43.2 cm Warranty: Frame: 5 years	<ul style="list-style-type: none"> • 5 position adjustable bench • 450 kg weight capacity • Angles achieved: flat, 30°, 45°, 60° and military • Built in wheels and handle • Heavy duty commercial grade upholstered pads • NOT compatible with the SportBench Dip & Chin-up
PBPB	Powerblock Power Bench Pro	€ 499.00

Body-Solid
Built for Life

In-Home Warranty

Frame & Welds	Lifetime
Pulleys, Bushings, Bearings, Hardware, Plates & Guide Rods	2 years
Cables, Upholstery & Grips (Normal Wear)	2 years

Body-Solid
Built for Life



Light Commercial Warranty

Frame & Welds	Lifetime
Pulleys, Bushings, Bearings, Hardware, Plates & Guide Rods	2 years
Cables, Upholstery & Grips (Normal Wear)	2 years

Body-Solid
Built for Life



Full Commercial Warranty

Frame & Welds	Lifetime
Pulleys, Bushings, Bearings, Hardware, Plates & Guide Rods	2 years
Cables, Upholstery & Grips (Normal Wear)	2 years

ENDURANCE
by Body-Solid

In-Home Warranty

Frame	Lifetime
Parts	2 years

ENDURANCE
by Body-Solid



Light Commercial Warranty

Frame	Lifetime
Motor	10 years
Running deck	5 years
Parts	2 years

Body-Solid ProClubLine



Full Commercial Warranty

Frame & Welds	Lifetime
Pulleys, Bushings, Bearings, Hardware, Plates & Guide Rods	2 years
Cables, Upholstery & Grips (Normal Wear)	2 years

POWERLINE
by Body-Solid USA

In-Home Warranty

Frame	10 years
Parts	2 years

BEST FITNESS
EQUIPMENT

Standard Warranty

Frame	5 years
Motor	5 years
Parts	2 years

aberunch
TOTAL

Standard Warranty

Frame	Lifetime
Parts	2 years

EVOCARDIO

Standard Warranty

Frame	Lifetime
Parts	2 years

WALKDESK
by EVO CARDIO

Standard Warranty

Frame	Lifetime
Motor	5 years
Running Deck	5 years
Parts	2 years

XTEERRA

Standard Warranty

Frame	10 years
Motor	5 years
Running Deck	5 years
Parts	2 years

BodyTrading

Standard Warranty

6 months

POWERBLOCK

Standard Warranty

Weights PowerBlock	5 years
Parts	3 years

WARRANTY

A

AAB-2	76
AB100	8
ACH18	80
ARC100	8
ARP100	8
ARUN050	8
ARUN100	8
ASKI100	8
ASKI150	9
ASKI200	9

B

BALBALL	109
BB23	79
BE105L	110
BE105M	110
BE105S	110
BE105XL	110
BE105XS	110
BE190NAOS	110
BFAB10	37, 46
BFAB20	37, 46
BFCCO10	33, 44
BFDR10	45, 68
BFFID10	29, 46
BFFID25	29, 46
BFFT10	34, 44
BFHYP10	39, 45
BFINVER10	38, 45
BFMC10	7, 44
BFMG20	18, 44
BFMG30	18, 44
BFOB10	28, 46
BFPL10	45
BFPR10	26, 45
BFPR100	26, 46
BFSB5	7
BFVK10	40, 45
BFWT10	45, 70
BSG10X	18
BSGLPX	18
BSTAB1	76
BSTART1	90
BSTART2	90
BSTART3	90
BSTART4	90

BSTART5	90
BSTAW10	78
BSTAW20	78
BSTB1	89
BSTB2	89
BSTB3	89
BSTB4	89
BSTB5	89
BSTBM1	89
BSTBM2	89
BSTBM3	89
BSTBM4	89
BSTBM5	89
BSTBM-PACK	89
BSTBPAD	79
BSTBR1530	89
BSTBR1550	89
BSTBR2030	89
BSTBR2050	89
BSTCB	84
BSTCH44	80
BSTDB	84
BSTDMB6	92
BSTDMB8	92
BSTDMB10	92
BSTDMB12	92
BSTDMB14	92
BSTDMB16	92
BSTDMB18	92
BSTDMB20	92
BSTDMB25	92
BSTFB4	91
BSTFB6	91
BSTFB9	91
BSTFB12	91
BSTFB15	91
BSTFB18	91
BSTFB24	91
BSTFB30	91
BSTFB36	91
BSTFM10	83
BSTFM20	83
BSTFMH	83
BSTFR36F	76
BSTFR36H	76
BSTFRP18	76
BSTFRP36	77
BSTFWH	99
BSTGT100	84

BSTGT150	84
BSTGT200	84
BSTHB10	93
BSTHB15	93
BSTHB20	93
BSTHB25	93
BSTHB30	93
BSTHRB20	94
BSTHRB30	94
BSTHRB40	94
BSTHRB50	94
BSTHRB60	94
BSTHRB70	94
BSTJR1	77
BSTLJ02	103
BSTLJHX	103
BSTMB2	91
BSTMB4	91
BSTMB6	91
BSTMB8	91
BSTMB10	91
BSTMB12	91
BSTMB14	91
BSTMB16	91
BSTMB20	91
BSTMB25	91
BSTMB30	91
BSTNG	84
BSTOBJ	103
BSTOBS	103
BSTOLP	85
BSTOPW	103
BSTPB6	88
BSTPB12	88
BSTPB18	88
BSTPB24	88
BSTPB30	88
BSTPB36	88
BSTPB42	88
BSTRINGS	77
BSTRT1	90
BSTRT2	90
BSTRT3	90
BSTRT4	90
BSTRT5	90
BSTRTDA	90
BSTSB45	93
BSTSB55	93
BSTSB65	93

BSTSB75	93
BSTSMB10	92
BSTSMB12	92
BSTSMB14	92
BSTSMB16	92
BSTSMB18	92
BSTSMB20	92
BSTSMB25	92
BSTSMB30	92
BSTSMB6	92
BSTSMB8	92
BSTSPBOX	88
BSTSR1	77
BSTSR10	77
BSTTT10	93
BSTTT15	93
BSTTT20	93
BSTVDK0.5	96
BSTVDK1	96
BSTVDK1.5	96
BSTVDK2	96
BSTVDK2.5	96
BSTVDK3	96
BSTVDK4	96
BSTVDK5	96
BSTVDK6	96
BSTWPBOX	88
BSTWV20	78
BSTWV40	79
BSTYB10	77
BSTYM10	84
BSTYM3	83
BSTYM5	84
BTPE1	108
BTPE2	108
BTPE3	108
BTSRB1	108
BTSRB2	108
BTSRB3	108
BTSRB4	108
BTSRB5	108
BTSRB6	108

C

CABLE5	62
CABLE6	62
CHDU1	106
CHDU10	106
CHDU1-10	106
CHDU2	106
CHDU3	106
CHDU4	106
CHDU5	106
CHDU6	106
CHDU7	106
CHDU8	106
CHDU9	106
CHDASET	106
CU100	109

D

DABB-S	61
DABB-SF	59
DBTC-S	61
DBTC-SF	59
DCLP-S	61
DCLP-SF	59
DGYM	61
DIOT-S	61
DIOT-SF	59
DLAT-S	61
DLAT-SF	59
DLEC-S	61
DLEC-SF	60
DPCC-S	61
DPCC-SF	60
DPEC-S	61
DPEC-SF	60
DPLS-S	61
DPLS-SF	60
DPRS-S	61
DPRS-SF	60
DR100	26
DR378	23
DT0100	109
DUMRACK	70

E

E400	6
E5000	6
ERG600W	12
ESB150	6
ESB250	6
EXM2750G	17
EXM4000G	17

F

F600-2	14
F600-3	14
FB300	6
FCD	40
FCD-BRKT	62
FCD-STK	61
FCDWA	14
FID46	30
FKR	14
FLP	14
FMH	14
FPU	14
FS2.5	11
FS3.5	11
FS3.9	11
FS4.0	12
FSX3500	12

G

G10B	15
G1S	15
G3S	15
G6B	15
G9S	15
GAB100	37
GAB300	38
GAB350	38
GAB400	38
GAB60	37
GAR100	73
GAR250	73
GBPR10	71
GBR10	83
GCA2	33
GCAB360	38
GCABBT-KIT	62

GCAB-STK	61
GCBT380	36
GCBT-STK	61
GCCA	16
GCCO150	33
GCEC340	42
GCECBT-KIT	62
GCEC-STK	61
GCLP100	42
GCLP100-25S	42
GCMH390	41
GDCC200	35
GDCC210	35
GDCC250	33
GDCCBAR	35
GDCCRACK	35
GDIB46L	28
GDIP59	32
GDKR100	70, 107
GDKR50	70, 107
GDR10	68
GDR24	68
GDR34	68
GDR363	68
GDR44	68
GDR48	69
GDR500	72
GDR60	69
GDR80	69
GDRT6	69
GFB350	29
GFI21	30
GFID100	30
GFID225	30
GFID31	30
GFID71	30
GFR500	71, 91
GFT100-1	34
GFT100-2	34
GFT100-3	34
GFT100SH	35
GHYP345	39
GIB2	77
GINV50	39
GIOT	16
GIOT-STK	62
GKR9	16
GKRT6	69
GL125L	110

GL125M	110
GL125S	110
GL125XL	110
GLA348	20
GLA378	23
GLA400	24
GLCE365	42
GLDA1	31
GLDA3	31
GLGS100	17
GLGS100P4	17
GLGSWH25	17
GLM83	36
GLM84	37
GLP	16
GLPH1100	43
GLPH1100-25S	43
GLPH1100S	43
GLPH2100	43
GLPH2100	50
GLP-STK	62
GLRA81	32
GMFP-STK	62
GMR10	72
GMR10	92
GMR5	72
GMR5	92
GMRT6	69
GOBH5	72
GOWT	70
GPA3	20
GPCA1	31
GPCB329	36
GPM65	32
GPR370	27
GPR370-25S	27
GPR378	23
GPR400	24
GPRDH	24
GPRTBR	24
GPRL	24
GPRWH	25
GPU348	21
GRCH322	39
GS348FB	20
GS348FB-25S	20
GS348Q	20
GS348Q-25S	20
GSCL360	42

GSCR349	44
GSR10	72
GSR10	93
GSRM40	32
GSS50	41
GST20	29
GSWT	71
GVKR60	40
GVKR82	40
GWS100	41
GWS100	88
GWT56	71
GWT66	71
GWT76	71
GYR500	73

H

HEXRU1	95
HEXRU2	95
HEXRU3	95
HEXRU4	95
HEXRU5	95
HEXRU6	95
HEXRU7	95
HEXRU8	95
HEXRU9	95
HEXRU10	95
HEXRU12.5	95
HEXRU15	95
HEXRU17.5	95
HEXRU20	95
HEXRU22.5	95
HEXRU25	95
HEXRU27.5	95
HEXRU30	95
HEXRU32.5	95
HEXRU35	95
HEXRU37.5	95
HEXRU40	95
HEXRU42.5	95
HEXRU45	95
HEXRU47.5	95
HEXRU50	95
HEXDU1-10	95
HEXDU-SETREK	95
HIPTR	108

K

KBC04	107
KBC06	107
KBC08	107
KBC010	107
KBC012	107
KBC014	107
KBC016	107
KBC018	107
KBC020	107
KBC022	107
KBC024	107
KBC026	107
KBC028	107
KBC030	107
KBC032	107
KBC036	107
KBC040	107
KBC044	107
KBC048	107
KBPO4	106
KBPO6	106
KBPO8	106
KBPO10	106
KBPO12	106
KBPO16	106
KBPO20	106
KBPO24	106
KBPO28	106
KBPO32	106
KBPO36	106
KBPO40	106
KBPO48	106

L

LB100	111
LB250	111
LBB28	85
LMCG	85
LMMG	85
LMPP	85
LMSE	85
LO378	24
LP275	17
LP40S	17
LVBP	57
LVIP	57

LVLA	57
LVLC	58
LVLE	58
LVLP	58
LVSP	58
LVSR	58

M

MA105	79
MA110B	110
MA110BL	110
MA110GR	110
MA110R	110
MA307	78
MA330	78
MB022A	80
MB022RG	80
MB100A	80
MB148A	80
MB148RG	81
MB229A	81
MB229RG	81
MB438RG	81
MB501RG	81
MB502RG	81
MB503RG	81
MB504RG	82
MB507RG	82
MCL200	111
MDE200	111
MFR	109
MGT100	109
MIBA1	108
MIBA2	108
MIBA3	108
MIBA4	108
MKIT100	111

N

NAS3	82
NB51	79
NB52	79
NB55	79
NB56	80
NB59	82
NB59A	82
NSH100	110

NTS10	82
-------	----

O

OAS14	104
OAS8	103
OB210FEM	101
OB220MA	100
OB34	99
OB48	99
OBPXCK5	97
OBPXCK10	97
OBPXCK15	97
OBPXCK20	97
OBPXCK25	97
OBPXK5	97
OBPXK10	97
OBPXK15	97
OBPXK20	97
OBPXK25	97
OLBAR150B	100
OLBAR150C	100
OLBAR180B	100
OLBAR180C	100
OLBAR220B	100
OLBAR220C	100
OLCLIP	101
OLDH	99
OLEZCB120B	100
OLEZCB120C	100
OLSL50	103
OLSPB220	100
OMG86	99
OPTK1.25	98
OPTK2.50	98
OPTK5	98
OPTK10	98
OPTK15	98
OPTK20	98
OPTK25	98
ORCK1.25	98
ORCK2.50	98
ORCK5	98
ORCK10	98
ORCK15	98
ORCK20	98
ORCK25	98
ORTK1.25	97
ORTK2.50	97

ORTK5	97
ORTK10	97
ORTK15	97
ORTK20	97
ORTK25	97
OTB50	99
OTB50RH	99
OWT24	70

P

P2X	18
PAB139X	37
PAB21X	37
PBBESP	117
PBBESPCA	117
PBBESPDA	117
PBBETR	117
PBCOM50	114
PBCOM90	114
PBEZB	117
PBKB	116
PBKH	116
PBPACK1	115
PBPACK2	115
PBPACK3	115
PBPACK4	115
PBPACK5	115
PBPB	117
PBPRO32	113
PBPRO32 (COMM)	114
PBPRO50	113
PBPROEXP2	113
PBPROEXP3	113
PBPROSET1	113
PBPROSET2	113
PBPROSET3	113
PBSB	117
PBSP24	112
PBSP50	112
PBSPEXP2	112
PBSPEXP3	112
PBSPSET1	112
PBSPSET2	112
PBSPSET3	112
PBSTLCO	116
PBSTPOW	116
PBSTPOWMAX	116
PBSTSMCO	116

PBSTU125R	116
PCCO90X	33
PCH24X	39
PDR282	68
PFID125X	29
PFID130X	29
PFT100	34
PFT50	34
PGM200X	42
PHG1000X	18
PHYP200X	39
PLA1000	63
PLA144X	19
PLA200X	26
PLA500	63
PLCE165X	41
PLM180X	36
PLPX	19
PMP150	27
POB44	28
PPA13X	20
PPB32X	36
PPR1000	25, 63
PPR1000EXT	25, 63
PPR200X	26
PPR500	25, 63
PPR500EXT	25, 63
PPRBP	63
PPRJ	63
PPRMCU	63
PPRPS	63
PPRTB	63
PPRUL	63
PPRWH	63
PSBSET	109
PSC43X	43
PSM1442XS	19
PSM144X	19
PSS60X	26
PUB2	76
PUB34	78
PUB5	76
PVKC83X	40
PVLP156X	41

R

R300	7
RF34B	86

RF36T	87
RF38R	87
RF546	86
RFBST4PB	86
RFBST4PS	86
RFL2	87
RFL2-PRO	87
RUNROCK	10

S

S1000	50
S2ABB-1	55
S2ABB-2	55
S2AC-1	55
S2AC-2	55
S2ACD-2	55
S2BTP-1	55
S2BTP-2	55
S2CC-1	35
S2CC-1	55
S2CC-2	55
S2CCO	34
S2CCO-1	54
S2CCO-2	54
S2CP-2	55
S2CP-3	55
S2FT-1	36
S2FT-1	54
S2FT-2	54
S2FT-3	54
S2IOT-1	56
S2IOT-2	56
S2LAT-1	56
S2LAT-2	56
S2LEC-1	56
S2LEC-2	56
S2LEX-1	56
S2LEX-2	56
S2LPC-2	56
S2LPC-3	56
S2MP-2	56
S2MP-3	56
S2PEC-1	57
S2PEC-2	57
S2SLC-1	57
S2SLC-2	57
S2SP-2	57
S2SP-3	57

SAB1300	38
SAB500	38, 50
SADRACK	69, 95
SAM900-2	48
SAM900-3	48
SB2.5	11
SBBR100	73
SBC600-2	47
SBC600-3	47
SBK1600-2	49
SBK1600-3	49
SBP100G-2	47
SBP100G-3	47
SBS100	73
SCB1000	50
SCB26	20, 43
SCC1200	33
SCC1200-1	49
SCC1200-2	49
SDB351G	51
SDC2000G-1	49
SDC2000G-2	49
SDIB370	27
SDKR1000DB	53, 74
SDKR1000KB	54, 75, 107
SDKR1000MB	54, 75
SDKR1000SD	53, 74
SDKR500DB	53, 74
SDKR500KB	54, 75, 106
SDKR500MB	54, 75
SDKR500SD	53, 74
SDKRDBL	53, 74
SDKRDBS	53, 74
SDKRKB	53, 74
SDKRMB	53, 74
SDKRSD6	53, 74
SDKRSD8	53, 74
SDKRUP2	53, 74
SDKRUP3	53, 74
SFB125	31
SFB349G	51
SFID325	31, 52
SFID325B	31, 52
SFID425	31, 52
SGH500	39, 50
SIB359G	51
SIP1400-2	48
SIP1400-3	48
SLC400G-2	47

SLC400G-3	47	SPRSF	66	T	
SLE200G-2	47	SPRSP	66	T50	6
SLE200G-3	47	SPRSS	66	TB15	101
SLM300G-2	47	SPRST	66	TBR10	85
SLM300G-3	47	SPRTB	66	TBR20	86
SLP500G-2	47	SPS12	53	TBR50	86
SLP500G-3	47	SR-BHV	66	TR2.0 i-Power	12
SLS500	43, 51	SR-DIP	66	TR20	82
SMH1500-2	48	SRM1700-2	49	TRMAT	87
SMH1500-3	48	SRM1700-3	49	TRX3500	12
SMR1000	50	SR-MGC	66	TS31	83
SODB250	28, 51	SRP10	98	U	
SOFB250	28, 51	SRP1-25	98	UB139	11
SOIB250	28, 52	SRP15	98	UB2.5	11
SOSB250	29, 52	SRP20	98	V	
SOT1800-2	49	SRP2-50	98	VDRA30	72, 83
SOT1800-3	49	SRP5	98	W	
SP150	19, 25	SR-REB	66	WDESK100	10
SP200	21	SR-SBH	66	WSA2-5	104
SP300	59, 60	SR-STEP	66	WSA5	104
SP300CH	59, 60	SR-UL	66	WSP15	62
SP50	34, 62	SR-WPH	66	WSP50	62
SPB368G	51	SSBR100	73	WT46	71
SPD700-2	48	SSBR200	73	WTB500	10
SPD700-3	48	SSP800-2	48	WTD600	10
SPR1000	22, 65	SSP800-3	48		
SPR1000BACK	23, 65	ST100	109		
SPR1000DB	23, 65	STBAR185	102		
SPR1000DBBACK	23, 65	STBAR210	102		
SPR250	27, 64	STBARTR180	102		
SPR500	22, 64	STBR500	50		
SPR500BACK	22, 64	STCLIP	102		
SPR500DBL	22, 64	STDH35	101		
SPR500HALFBACK	22, 64	STDH40	101		
SPRACB	66	STDHTR35	101		
SPRBACK	66	STDHTR40	101		
SPRBCB	66	STEZCB120	102		
SPRBP	66	STEZCBTR	102		
SPRCB	66	STH1100G-2	49		
SPRCU	25	STH1100G-3	49		
SPRCUA	66	STK	62		
SPRDCB	66	STM1000-2	48		
SPRHLA	22, 64, 66	STM1000-3	48		
SPRHT	66	STT45	78		
SPRJAM	66	SVKR1000	40, 52		
SPRJC	66	SWT1000	52, 72		
SPRMB	66	SWT14	70		
SPRPS	66				
SPRSA	66				

- All indications concerning prices, quantities, delivery timing and conditions, in whatever form, are without engagement.
- Orders: an order placed shall only be binding upon the seller after written confirmation on his part.
- Cancellation: an order may be cancelled by the seller without any compensation even if it has already been confirmed in writing:
 - a. If the purchaser has not fulfilled an earlier contract
 - b. In the event of force majeure
- Force majeure includes war, strike, lockout, rebellion, mutiny, anticipated of actual adverse weather conditions and all circumstances which prevent a normal delivery and/or dispatch of the goods.
- If the purchaser cancels an order wholly or in part, he shall be bound to compensate the seller for loss of profit, estimated at 30% of the total amount of the cancelled order.
- Unless otherwise agreed, prices shall be calculated in Euro. They shall not be binding, F.O.B from the seller's premises or ex nursery, i.e. without discount, freight or packing.
- The goods travel for the account and at the risk of the purchaser. All costs of delivery shall be paid by the purchaser.
- At the mention of an erroneous delivery address, a cost of 9.00 will be charged.
- The mentioned delivery date is indicative. The purchaser has, based on the sole fact of the delay, no right to indemnification, nor the right to brake the contract.
- The conformity of the delivery has to be checked by the purchaser at the reception of the goods. Inaccuracies in the delivery and visible defects have to be indicated on the delivery note and confirmed in writing to FITNESSTRADING after maximum 5 working days. FITNESSTRADING can be kept in the end to replace the non-confirm delivered goods. Used or transformed goods are supposed to be accepted by the purchaser.
 - Packaging and content of the non-conform delivered goods have to be kept by the purchaser.
 - The return of the delivered goods has to be done in the original packaging, after previous written notice by FITNESSTRADING concerning shipment en other instructions, maximum 8 days after reception of the latter. Until the goods are conform and safely delivered at FITNESSTRADING, the purchaser is responsible for the goods.
- Other complaints have to be communicated in writing to FITNESSTRADING directly and maximum 10 days after the observation of the problem. The exact identity of the defective goods and the nature of the defect and/or damage have to be stated. FITNESSTRADING is not responsible for damage, which occurs after this period of 10 days, or for damage, which occurs due to too late communication.
- The liability of FITNESSTRADING is limited to its relationship with the purchaser. The purchaser is obliged to impose this restriction to its co-contractors.
- A complaint does not relieve the purchaser from its obligation to pay.
- The liability of FITNESSTRADING for the delivered goods is limited to the imperative legal rules concerning product liability. If FITNESSTRADING purchased the goods itself at a third party, it can only be kept responsible within the bounds of the warranties and engagements of its suppliers towards itself.
- The liability of FITNESSTRADING for possible defects in the delivered goods is in any case explicitly excluded in case of:
 - illegitimate ignorance by the purchaser concerning the defects;
 - when the purchaser does, itself or by third parties, make reparations or transformations, without informing in writing FITNESSTRADING in advance;
 - defects resulting from the use and the age of the delivered good.
 - in case the delivered goods are applied or transformed in a way which is not confirm the approved manner or the relevant instructions which are supposed to be known by each purchaser and applicator.
- The goods are payable net without discount, at the company seat under terms indicated on your invoice. Terms need to be respected.
 - In the event of late payment, interest at 12% per year shall be deemed to be lawfully due without further notice. A fixed compensation at 15% on the invoice amount shall also be deemed without further notice.
- Complaints about invoices must be expressed in writing within 8 days after reception of goods. Complaints after those 8 days can no longerbe accepted.
- Unless paid in full the goods remain our property. The buyer will be liable for all risks.
- The present general terms and conditions apply to all agreements. The non-application of one of these clauses doesn't mean the non-application of the other clauses.
- The Belgian law applies.
- In any case of argument the courts of the judicial district Hasselt have exclusive competention. However, FITNESSTRADING will have the right to call in the national law of the domicile, registered office, administrative seat, exploitation seat, branch company or office of the Purchaser, should this law be more favorable to FITNESSTRADING than the Belgian law.

FITNESSTRADING

Stadsheide 3 / 3500 Hasselt / Belgium / +32 (0) 11 76 12 70 / info@fitnesstrading.com