

Hurom™

HT Series



02

IMPORTANT
SAFEGUARDS

04

Precautions for safe use

06

Terms for Parts

08

How to assemble

10

How to use

11

Cautions during
operation

12

How to use control
lever [by mode / by
ingredients (Juicing)]

14

How to trim the
ingredients! / Use by
strainer types

15

When squeezing screw
stops during operation
/ Caution when using
operation button

16

How to Clean

18

Before Requesting for
Repair

20

Product Specifications /
Warranty

Hurom Juicer Household Use (Warranty Included)

1. Read 'Precautions for safe use' (Page 2) and use the appliance properly.
2. After finish reading the manual, keep it in a convenient location for future reference.
3. Do not use it abroad which has different power supply and voltage.
4. Any quality improvements are subject to change without notice.

IMPORTANT SAFEGUARDS

1. WHEN USING ELECTRICAL APPLIANCES, BASIC SAFETY PRECAUTIONS SHOULD ALWAYS BE FOLLOWED. READ ALL INSTRUCTIONS.
2. TO PROTECT AGAINST RISK OF ELECTRICAL SHOCK, DO NOT PUT THE MAIN BODY (MOTOR) IN WATER OR ANY OTHER LIQUID.
3. CLOSE SUPERVISION IS NECESSARY WHEN ANY APPLIANCE IS USED NEAR CHILDREN.
4. UNPLUG FROM OUTLET WHEN NOT IN USE, BEFORE ASSEMBLING OR TAKING OFF PARTS AND BEFORE CLEANING.
5. AVOID CONTACT WITH MOVING PARTS.
6. DO NOT OPERATE ANY APPLIANCE WITH A DAMAGED CORD OR PLUG, OR AFTER THE APPLIANCE MALFUNCTIONS, OR IS DROPPED OR DAMAGED IN ANY MANNER. RETURN APPLIANCE TO THE NEAREST AUTHORIZED SERVICE FACILITY FOR EXAMINATION, REPAIR OR ELECTRICAL OR MECHANICAL ADJUSTMENT.
7. THE USE OF ATTACHMENTS NOT RECOMMENDED OR SOLD BY THE MANUFACTURER MAY CAUSE FIRE, ELECTRIC SHOCK OR INJURY.
8. DO NOT LET CORD HANG OVER EDGE OF TABLE OR COUNTER.
9. ALWAYS MAKE SURE HOPPER IS SECURELY FASTENED IN PLACE BEFORE MOTOR IS TURNED ON. DO NOT UNFASTEN HOPPER WHILE JUICER IS IN OPERATION.
10. BE SURE TO TURN SWITCH TO OFF POSITION AFTER EACH USE OF YOUR JUICER. MAKE SURE THE MOTOR STOPS COMPLETELY BEFORE

DISASSEMBLING.

11. DO NOT PUT YOUR FINGERS OR OTHER OBJECTS INTO THE JUICER WHILE IT IS IN OPERATION. IF FOOD BECOMES LODGED IN OPENING, USE FOOD PUSHER OR ANOTHER PIECE OF FRUIT OR VEGETABLE TO PUSH IT DOWN. WHEN THIS METHOD IS NOT POSSIBLE, TURN THE MOTOR OFF AND DISASSEMBLE JUICER TO REMOVE THE REMAINING FOOD.
12. DO NOT USE OUTDOORS.
13. DO NOT PLACE ON OR NEAR A HOT GAS OR ELECTRIC BURNER OR IN A HEATED OVEN.
14. DO NOT USE APPLIANCE FOR OTHER THAN INTENDED USE.

SAVE THESE INSTRUCTIONS

Precautions for safe use

1. You should read <Precautions for safe use>.
2. You should follow <Precautions for safe use>.
3. Precautions are classified as following.



Warning When violating the labeling requirement, it may cause serious injury or death.

- **DO NOT PLUG OR UNPLUG WITH WET HANDS.** It may cause electric shock or injury.
- **DO NOT USE OTHER THAN 120 V AC.** It may cause electric shock, fire or product failure.
If the voltage is different, it may shorten the life of the motor or cause a failure.
- **PLUG THE POWER CORD CORRECTLY AND PUSH IT TIGHT IN A WALL SOCKET.**
It may cause an electric shock or a fire.
- **IF THE SUPPLY CORD IS DAMAGED, IT MUST BE REPLACED BY THE MANUFACTURER OF ITS SERVICE OR SIMILARLY QUALIFIED PERSONS IN ORDER TO AVOID A HAZARD.**
If the power cord is damaged, it may cause electric shock or fire.
- **NEVER ALTER THE APPLIANCE. ALSO, DO NOT DISASSEMBLE OR REPAIR THE PRODUCT BY YOURSELF. DO NOT INSERT FINGERS, FOREIGN SUBSTANCES OR OBJECTS SUCH AS PINS INTO GAPS OR HOLES IN THE BODY.** It may cause a fire, electric shock or product failure. For any technical support, contact the authorized local Customer Service Center.
- **WHEN THE POWER CORD, WIRE IS BROKEN OR DAMAGED, OR THE PLUG-IN PART BECOME LOOSE, DO NOT OPERATE IT.** It may cause electric shock, fire or injury.
- **DO NOT MOISTEN BODY OR SPLASH WATER ON THE BASE.**
Be careful not to let any liquids or other substances get into the switch of the appliance.
- **DO NOT OPERATE THE SWITCH WITH WET HANDS.** It may cause an electric shock or fire.
- **FOR SAFETY, MUST DO GROUNDING CONNECTION. ALSO, DO NOT DO THE GROUNDING ON GAS PIPE, PLASTIC WATER PIPE, TELEPHONE WIRE, ETC.**
It could cause electric shock, fire, malfunction or explosion. Be sure to use the electrical outlet with ground connection.
- **NEVER DISASSEMBLE THE CHAMBER SET DURING OPERATION OR INSERT FINGERS, FOREIGN OBJECTS SUCH AS FORKS, SPOONS, ETC. INTO HOPPER CHUTE OR JUICE OUTLET.** It may cause injury, accident or product failure.
- **APPLIANCES CAN BE USED BY PERSONS WITH REDUCED PHYSICAL, SENSORY OR MENTAL CAPABILITIES OR LACK OF EXPERIENCE AND KNOWLEDGE IF THEY HAVE BEEN GIVEN SUPERVISION OR INSTRUCTION CONCERNING USE OF THE APPLIANCE IN A SAFE WAY AND IF THEY UNDERSTAND THE HAZARDS INVOLVED. CHILDREN SHALL NOT PLAY WITH THE APPLIANCE. CLEANING AND USER MAINTENANCE SHALL NOT BE MADE BY CHILDREN. THIS APPLIANCE SHALL NOT BE USED BY CHILDREN. KEEP THE APPLIANCE AND ITS CORD AWAY FROM CHILDREN.**



Caution When violating the labeling requirement, it may cause serious injury or damage to the appliance.

- **DO NOT OPERATE WITHOUT LOCKING THE HOPPER PROPERLY.** It may cause an injury or a failure.
- **WHEN A GAS LEAK IS DETECTED, DO NOT INSERT THE POWER CORD INTO ITS SLOT. OPEN THE WINDOW IMMEDIATELY FOR AIR VENTILATION.** It may cause injury or failure.
- **NEVER PUT A FINGER, FORK OR SPOON, ETC. INTO JUICE OUTLET.** It may cause injury or failure.
- **IF SQUEEZING SCREW ROTATION IS STOPPED DURING NORMAL OPERATION, PRESS [REV] BUTTON AND HOLD FOR 3~5 SECONDS AND AFTER REVERSE OPERATION IS COMPLETELY STOPPED, PRESS [ON] BUTTON AGAIN.** If stopping continues during the operation, the parts may be damaged and performance may be deteriorated due to overheating in a motor. When the problem continues, stop the appliance immediately and contact the local Customer Service Center.
- **DURING THE OPERATION, DO NOT ATTEMPT TO MOVE THE BASE, DISASSEMBLE THE CHAMBER SET OR PARTS AND TRY TO LOCK THEM.** It may cause an injury or a failure. If any act of event needed, switch off first and unplug the power cord.
- **WHEN USING THE APPLIANCE, BE CAREFUL WITH A NECKTIE, LONG NECKLAGE, SCARF, ETC. TO NOT BE ENTANGLED INTO HOPPER CHUTE.** It may cause injury, failure or breakage.
- **PLACE THE APPLIANCE ON A FLAT AND STABLE SURFACE.** It may cause injury or failure.
- **DO NOT OPERATE THE APPLIANCE FOR MORE THAN 30 MINUTES AT A TIME.**
It may cause a motor failure due to overheating. Cool it down sufficiently about 5 minutes and operate it again.
- **WHEN PLACING INGREDIENTS INTO THE HOPPER CHUTE, USE ONLY THE PUSHER PROVIDED.** It may cause injury or failure.
- **DO NOT ALLOW A SEVERE SHOCK TO THE APPLIANCE OR DROP IT.** It may cause electric shock, fire or damage.
- **IF THE APPLIANCE GIVES OFF AN UNPLEASANT SMELL, EXCESSIVE HEATING, OR SMOKE, STOP USING IMMEDIATELY AND CONTACT THE LOCAL CUSTOMER SERVICE CENTER.** When using a new appliance, it gives off a smell and the smell disappears naturally over time.
- **ALWAYS UNPLUG THE APPLIANCE AFTER USE. ALWAYS DISCONNECT THE APPLIANCE FROM THE SUPPLY IF IT IS LEFT UNATTENDED AND BEFORE ASSEMBLING, DISASSEMBLING OR CLEANING. WHEN UNPLUGGING THE POWER CORD, MAKE SURE TO HOLD THE POWER CORD.** Pulling the wire to unplug may cause electric shock or fire.
- **DO NOT WASH AT HIGH TEMPERATURES OF 80°C(176°F) OR HIGHER. DO NOT PUT THE APPLIANCE IN A DISHWASHER, DRYER OR A MICROWAVE ETC.** It may cause a failure or parts deformation.
- **THE APPLIANCE WEIGHS ABOUT 5.3kg. WHEN MOVING THE APPLIANCE, ENSURE TO MOVE IT HOLDING GRIPS TIGHTLY AT THE BOTTOM OF BODY WITH BOTH HANDS.** By attempting to hold chamber or the edge of the body, the body may fall causing an injury or failure.

Terms for Parts

1. Pusher



2. Hopper Lid



3. Hopper



Hopper Chute

Safety Sensor (▲)



4. Squeezing Screw



Screw axis

5. Fine Strainer

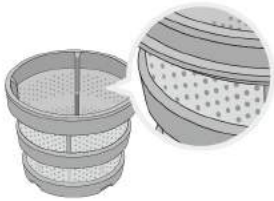

6. Coarse Strainer

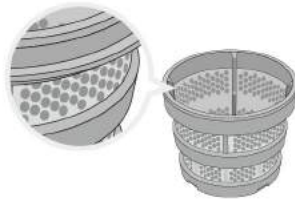

7. Spinning Brush



Silicone Brush

Brush holder

8. Chamber



Chamber packing

Pulp Outlet

Juice Outlet

Control Lever

Juice Cap

Juice cap packing

9. Body

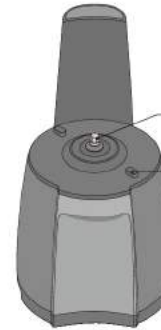

Shaft

Body bump

10. Juice Container Lid



11. Juice Container



12. Pulp Container



13. Cleaning Brush



14. Small Cleaning Brush

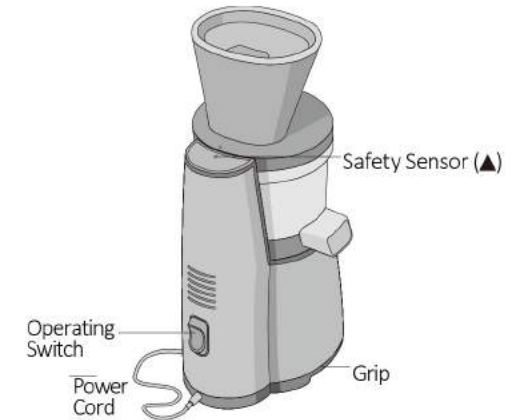

Safety Sensor (▲)

Operating Switch

Power Cord

Grip

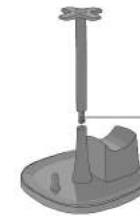

15. Chamber Rack

*Chamber Rack can't be separated after assembling.

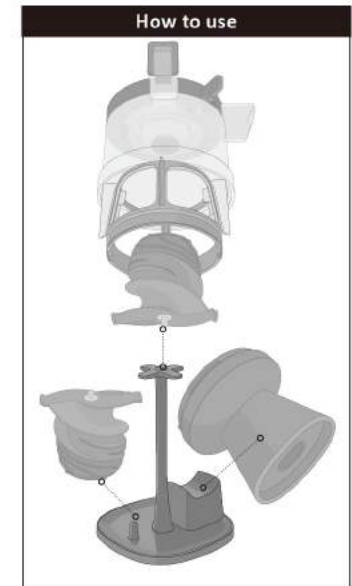

How to assemble

1 Assemble the strainer under the groove of spinning brush just like from the picture.
If they are not completely assembled, the chamber set will not be closed.

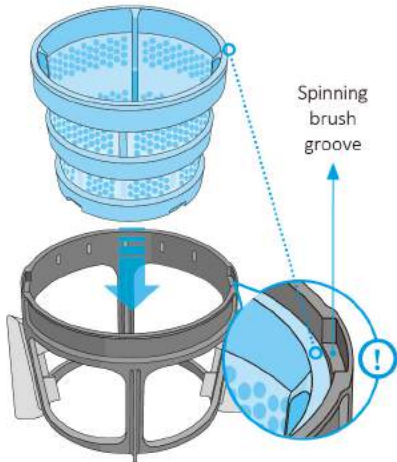

* If the strainer is not placed below the groove, the hopper will not be locked.

2 Put the assembled part in proper place by moving left and right in the chamber just like the picture no.1.

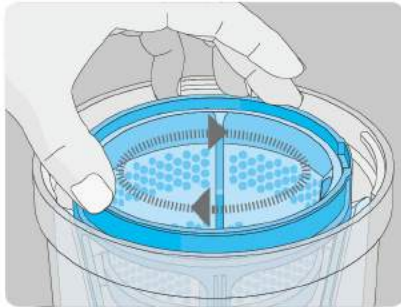
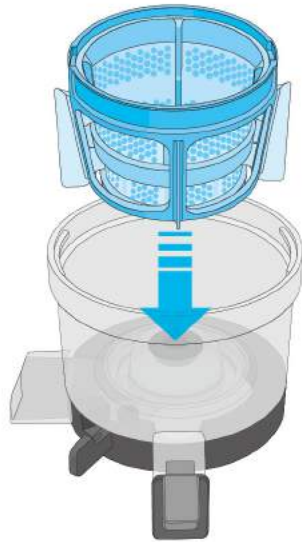

3 Assemble the squeezing screw like the picture.
Put the auger by turning it to fit in the spinning brush grooves.

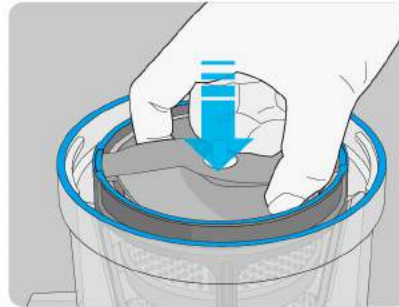
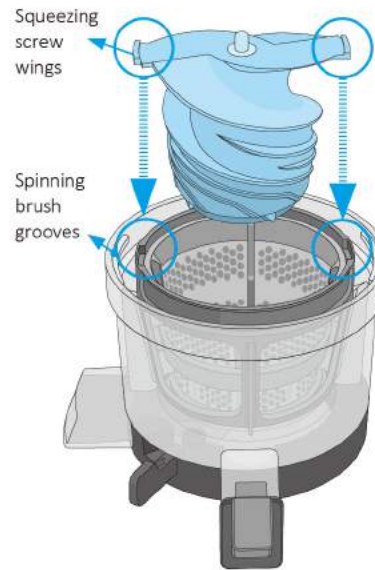

4 After putting the hopper on the chamber, turn it clockwise until it is locked completely.

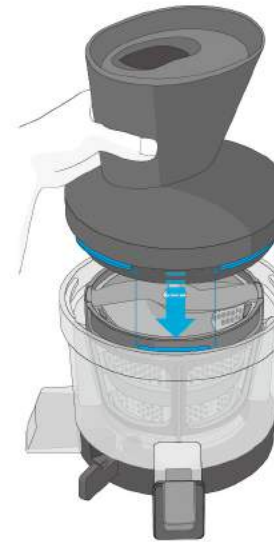

5 Mount the chamber set on the body.
Make sure the lever is placed in **●** CLOSE position.

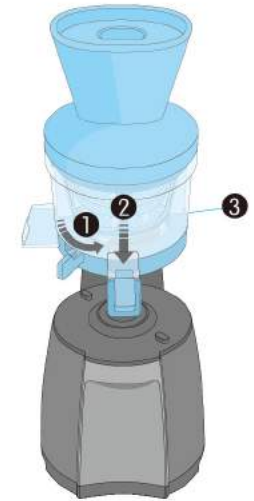

The chamber set will not fit in to the base if the lever is placed in **●** CLOSE position.



Assemble the bottom of the chamber to bump of the body.

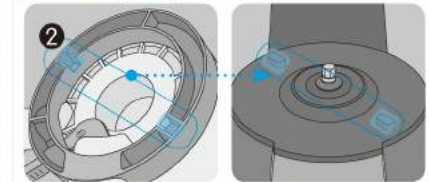

Please assemble according to the safety sensor. The appliance will not work if the chamber set isn't assembled well even though it is on the body.

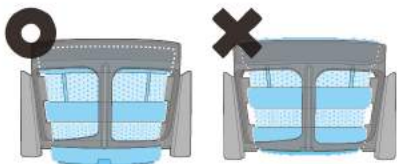

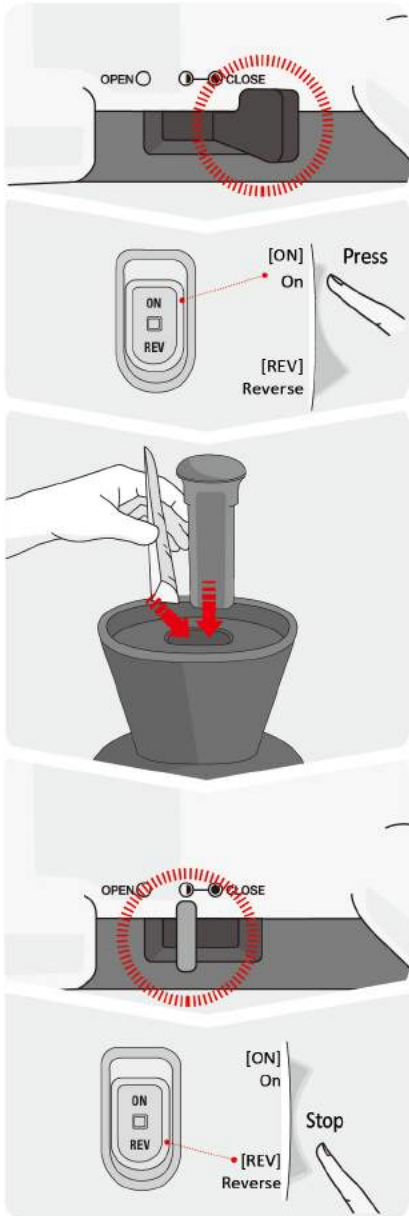

1 Place the control lever into CLOSE (● CLOSE) position before operating.
 The chamber will not be assembled with body if the control lever is not into CLOSE (● CLOSE) position.

2 Press [ON] button to start.
 For your safety, this appliance only works when it's correctly assembled with chamber set.

3 Put ingredients gradually in the hopper chute and press with the pusher.
 Do not press the ingredients with anything except the pusher provided.
 Please put the ingredients as 3~4cm sizes.
 When you extract over 400ml at once, please open the control lever every 400ml to emit the pulp.

4 Place the control lever in half-open (◐) putting the last ingredients.
 The hopper will be opened easily as long as the residues in the strainer are released.

5 After extraction is completed, place the switch in the [REV] position.
 Stop the machine slowly after press the button for safety and product performance.

- **Ingredients which needs caution.**
 It may cause damage or failure.
 - Fruits with hard seeds such as persimmon, Japanese apricot, lemon, plum, peach etc. that are hard to chew with our teeth should be taken out before extraction.
 - For stalk vegetables with strong fiber such as water parsleys, celery etc. should be cut into small size about 3~4cm before putting into the hopper chute.
 - Do not put in sesame, coffee beans, bark of the tree, Chinese pepper, etc. which cannot be extracted.
 - Do not put in fruits preserved in alcohol, sugar, honey, etc. (grapes, apricot, berries, etc.) and enzymes (glasswort, house leek, etc.).
- **We recommend you to drink green vegetable juice and fruit juice immediately after extraction rather than keeping them for long time.**
- **Do not use for grinding grains.**
 - It may cause damage or failure.
- **Do not re-squeeze residues expelled through the pulp outlet.**
 - Soft fruits can be re-squeezed.
- **Do not operate the appliance before putting in the ingredients.**
- **Do not use the appliance for more than 30 minutes continuously.**
 - It may cause a failure due to overheating of the motor.
 - When using continuously, stop it and give it 5 minutes of interval and then you may use it again.
- **Never insert finger, fork or spoon etc. into juice outlet during the operation.**
 - Inserting such as chopsticks etc. into Juice outlet during operation may cause them to stuck into the spinning brush and cause damage to the parts.
- **Do not press the ingredients with anything except the pusher.**
 - It may stick to the screw and cause injury and failure.
- **Do not operate the switch with wet hands.**
 - It may cause electric shock or fire. Do not put foreign objects near the switch.
- **When you extract over 400ml at once, please open the control lever every 400ml to emit the pulp.**
 - The hopper can't be opened or it may cause damage when the pressure in the chamber increases.

NOTE When using [ON] or [REV] button, make sure that the squeezing screw is completely stopped.

NOTE Withered ingredients because of refrigerated for long term may make small amount of juice or impossible to make juice. If the unit is not cleaned immediately after use, a residue may dry and stick to the unit. This will make assembling and cleaning difficult as well as lead to performance degradation.

How to use control lever by mode

- The control lever is between the juice cap and pulp outlet.
- The control lever has various functions and can help to extract juice by characteristic of ingredients except extract function.

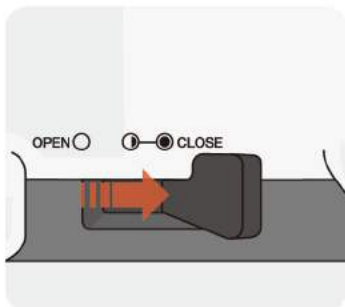

● CLOSE Preparation/Extraction mode

For general ingredients, the extraction rate is good when you close (● CLOSE) the control lever during operation. When you extract over 400ml at once, please open the control lever every 400ml to emit the pulp.

For juicing the fruits with hard seeds, such as grapes, rubus coreanus, and pomegranates, place the control lever into close (● CLOSE) and switch into half-closed(Ⓢ) position when the juice begins to come out.

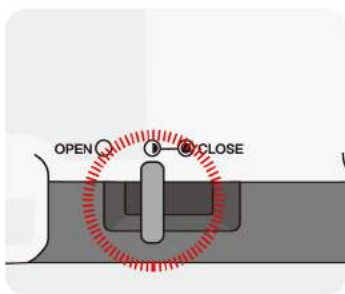

Ⓢ Completion, Simple Cleaning Mode

Place the control lever into half-closed(Ⓢ) position when putting in the last ingredients and release the residues. The hopper will open easily when the residues in the strainer are released.

For Simple Cleaning Mode, place the control lever into half-closed (Ⓢ) position and release the residues.

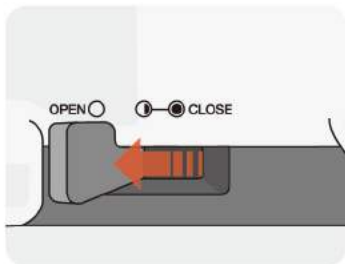

○ OPEN Cleaning Mode

When detaching and cleaning the chamber, place the control lever completely into (○ OPEN) position. You can easily and conveniently clean the chamber.

NOTE

When it is hard to open the hopper after the operation:

- Place the control lever into half-closed (Ⓢ) position and press Reverse button for about 3~4 seconds. Repeat this for 2~3 times and the hopper will be open easily.

How to use control lever by ingredients (Juicing)

- Use the control lever by the properties of each ingredients, you can make a more delicious juice.

Ingredients

Apple, pear, melon, watermelon, strawberry, blueberry, orange, grapefruits, lemon, mango, plum, peach, cherry, persimmon, pineapple, wheat-grass, parsley, celery, dandelion, carrot, ginger, potato, beet, tomato, paprika, broccoli, cauliflower, cabbage, kale, spinach, Cooked sweet potato and pumpkin, Cone.



1. Start as ● CLOSE position.

2. When extraction is almost finished, place the control lever into, Ⓢ Half-Opened position

Seed ingredients

Grapes, pomegranate, blackberry, kiwi



1. Start as ● CLOSE position.

2. When juice starts to come out, place the control lever into when juice starts to come out.

Mixed with Milk

Banana, strawberry and blueberry, etc.

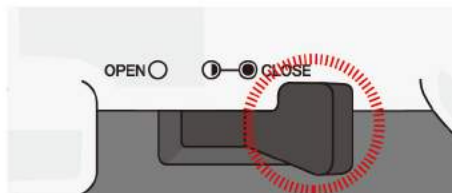

1. Start as ● CLOSE position.

How to trim the ingredients!

- * This is a reference about how to trim the ingredients, so if you have allergy please choose your own proper ingredients.
- * Please refer to the recipe book for the product usage of each ingredient.

For juicing

Apple, pear, kiwi, oriental melon Fruits like apple, pear, kiwi, oriental melon, etc. put them with seeds and peels. However, apple seeds contain toxicity, so it is better to remove them.

Pomegranate, grapes Separate each grape from the cluster. Peel the pomegranate and use flesh only.

Watermelon, orange, grapefruit Peel off the skin of watermelon, orange, grapefruit and cut them into right size.

Mango, cherry, peach Fruits like mango, cherry, peach, or plum, etc. have hard seeds which are hard to swallow. Those seeds might cause stoppage or parts damage, so they must be removed before using it.

Wheat, chives Put a handful of wheat or chives in not to be scattered.

Water parsleys, angelica, celery, kale Cut fibrous ingredients into small sized less than 3cm.

Use by strainer types

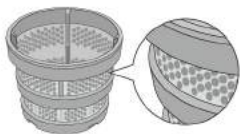

Coarse Strainer

Coarse strainer has larger holes so is good to make thick juice with flesh in it.

It is to make juice with soft fruits and thick juice like banana, strawberry, and also useful for smoothie, latte, or soup.

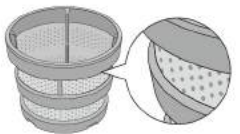

Fine Strainer

Fine strainer has tiny and fine holes good to make clean juice.

When squeezing screw stops during operation

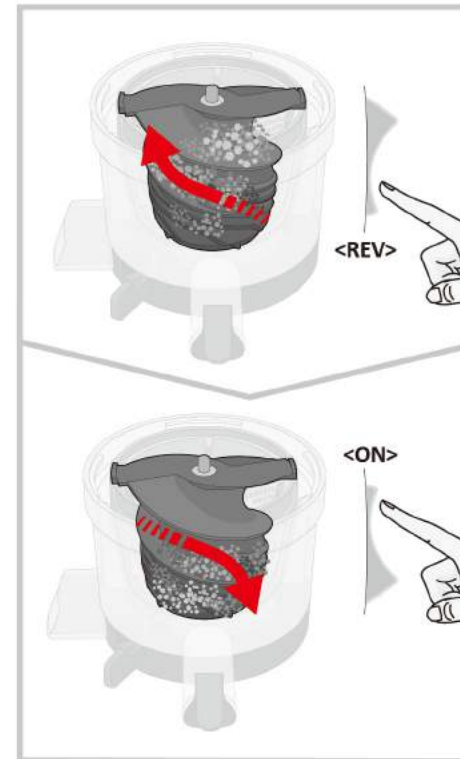

1 Press [REV] button on the operating switch for about 2~3 seconds and stop it. Repeat this 2~3 times.

[REV] is the button to push back the ingredients upward.

[REV] only works while pressing the button, and the rotation of the squeezing screw stops if you release the button.

2 Press [ON] button to operate after reverse operation is completely stopped.

When using [ON] or [REV] button, make sure that the squeezing screw stops completely.

NOTE

Even after following the directions above and still doesn't work, please unplug the power cord and disassemble chamber set, and clean it. And try it again.

Caution when using operation button

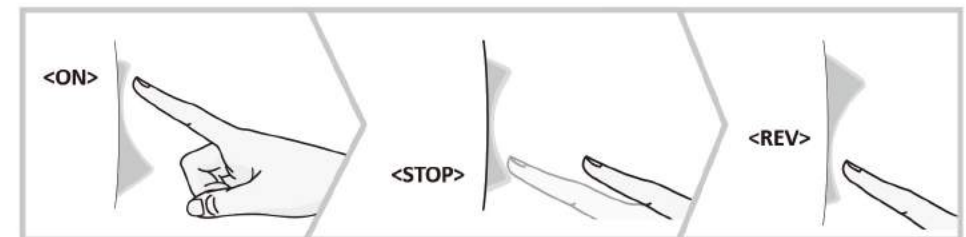

NOTE

In case of reversing during operation, press [REV] button shortly to stop the appliance, then you press [REV] button for operation.

From the feature of the product, even though you stop the operation, it doesn't stop right away. It rotates slowly then stops. If the rotation stops completely, you may press the button to any direction you want.

How to Clean

Clean the parts

1. Unplug the power cord with dry hands after the unit has been completely stopped.
2. Remove the chamber set from the main body. Twist the hopper to open and lift up the parts in order to disassemble the unit.
3. Use a cleaning brush and wash the chamber set under running water.
4. Open the control lever (OPEN ) and juice cap to wash the chamber
5. Wipe the main body with a damp towel or a soft cloth.
6. The silicone packing can be disassembled and washed. (Including juice cap packing, chamber packing, silicone brush)
7. Soak in water diluted with one or two drops of baking soda or natural bleach for dishes for about 30 minutes to sterilize and clean.

※ When you clean the chamber set, wash the residue inside of the chamber first. And then disassemble the chamber packing and wash it under running water.

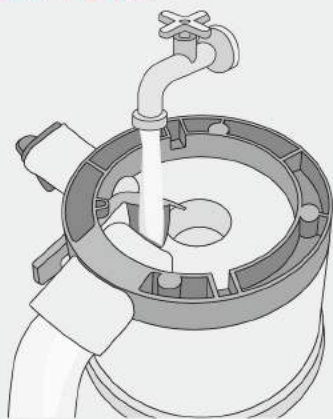

NOTE

1. If the chamber is not cleaned immediately after use, a residue may dry and stick to the unit. This will make disassembling and cleaning difficult as well as lead to performance degradation. Please wash the chamber set immediately after use.
2. Do not wash with hot or boiling water, an iron scrubber, abrasive material, sink solvents, or sharp cleaning tools. Do not put it in a dishwasher or dish dryer. After washing, thoroughly and naturally dry, and store in a clean area.

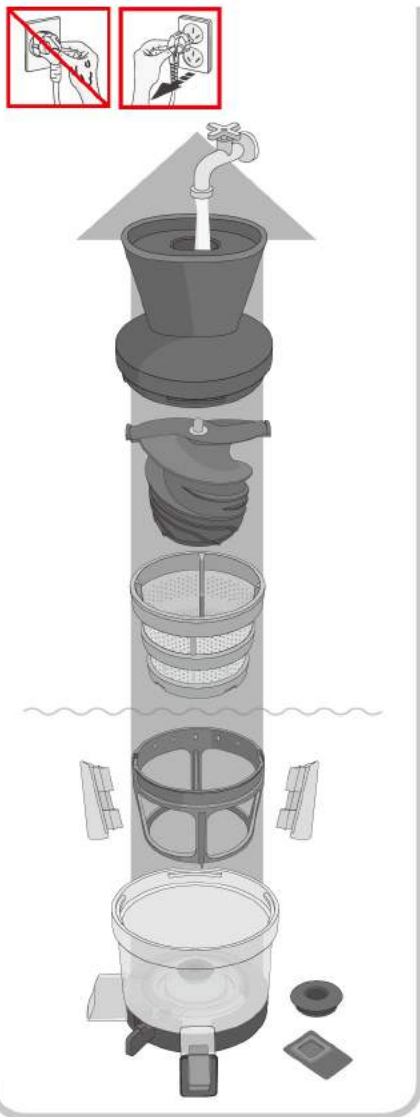

Juice Cap Packing

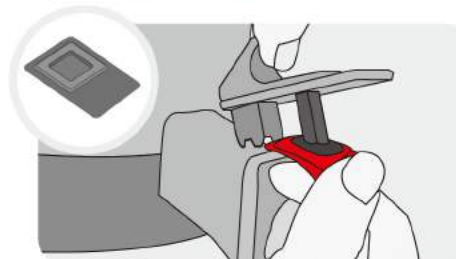

Open the juice cap, hold the chamber and juice cap with one hand, and remove the juice cap packing with your other hand to disassemble.

Please be careful not to drop or damage the juice cap and chamber when disassembling the unit.

Chamber Packing

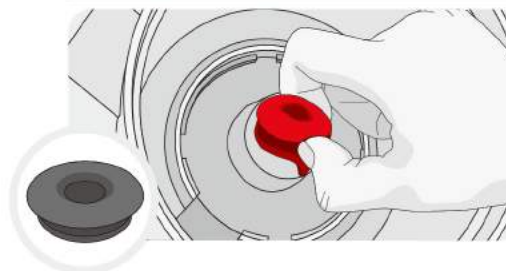

Pinch the chamber packing with two fingers and twist to separate.

Please assemble the upper and lower parts correctly. (Refer to chamber packing image on the left.)

※ When you clean the chamber set, wash the residue inside of the chamber first. And then disassemble the chamber packing and wash it under running water.

Spinning Brush

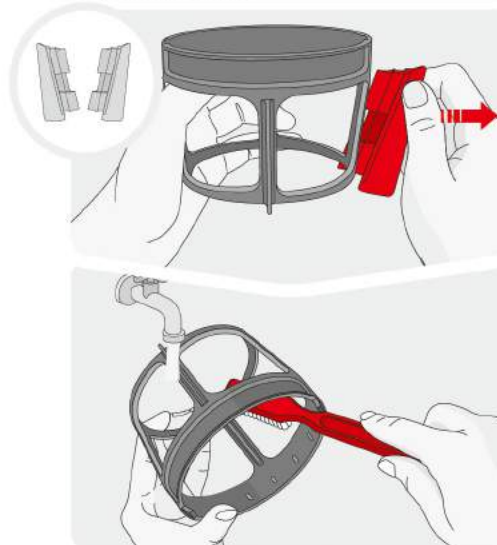

1 Remove the silicone brush from the pinning brush holder.

Please follow the recommended method to separate the silicone brush. Otherwise, it may cause damage of spinning brush holder and silicone brush.

2 Use a cleaning brush and wash the inside and outside of the spinning brush holder under running water.

Wash the silicone brush under running water as the same method.

Before Requesting for Repair

- If you need additional information, please contact your local Customer Service Center or visit www.hurom.com. When applying for after-sales service, please have the manufacturer's serial number or bar code available.



1. The main body itself will not work.

For your safety, this unit only works when it's correctly assembled with the chamber set.

3. The Appliance does not work.

Make sure that the power cord is properly plugged in.

Check if the hopper is assembled properly.

If the hopper has not been locked into place, the appliance will not operate for safety reasons.

Check if the appliance is assembled according to the directions in the manual.

Refer to instructions for assembly in the manual or consult with your Customer Service Center for additional assistance.

4. The appliance stops during normal operation.

Have you inserted heavy loads or large pieces of ingredients into the appliance?

Refer to page 15 of the manual and follow the guideline for using [REV] button.

If the issue is not resolved after following the above process, please contact your local Customer Service Center.

5. The hopper does not open.

There might be a lot of residues inside. Put the control lever in half-closed (Ⓢ) position, and press [ON] button to release residues. Press [REV] button for 3~5 seconds and stop it.

Repeat this process 2~3 times.

Have you placed any foreign substances or solid objects (hard seed such as persimmon seed) in the juicer?

Press [REV] button and push the ingredients back up toward the hopper chute.

Do not attempt to open by force. Please contact your local Customer Service Center for assistance.

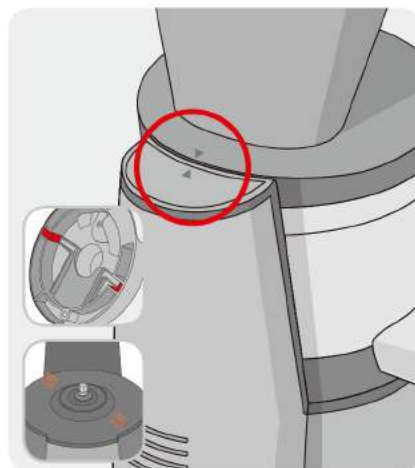

2. Please assemble according to the safety sensor.

For your safety, this unit only works when it's correctly assembled.



6. Do not insert too many ingredients at once.

If you insert an excessive amount of ingredients or thick ingredients, the unit may stop.

8. Juice leaks over the body.

Have you inserted a lot of ingredients into the hopper chute?

If you insert a large amount of ingredients compared to the pulp outlet, the packing is slightly pushed away, so the juice leaks out of the gap. Do not put too much ingredients by force and just put gradually for extraction.

9. There are fine lines or scratch marks around the squeezing screw.

These are molding marks resulting from the normal manufacturing process.

This is a normal product and there is no problem for use.

10. The Chamber shakes when squeezing.

Slight shaking may be caused by the motor.

Depending on the texture of the ingredient, there may be slight shaking.

This is a normal phenomenon as squeezing screw rotates and it is not a malfunction. Hard ingredients (e.g. carrot, potato, radish, beet, etc.) may cause more shaking than soft ingredients.

11. Chamber set does not fit into the body.

If the control lever is in OPEN ○ position, the chamber set does not fit in to the body. Before assembling the chamber set, make sure that the control lever is in ● CLOSE position.

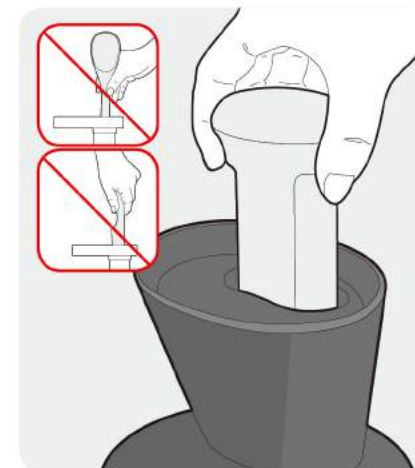

7. Do not use in ways other than pressing on the pusher in the inlet.

It may cause damage, injury, etc.

Product Specifications

• Product Name	Hurom Slow Juicer	• Cord Length	1.4 m
• Model Name	HT Series	• Motor	Single-phase induction motor
• Rated Voltage	120 V	• Fuse	250 V 8 A
• Rated Frequency	60 Hz	• Weight	5.3 kg
• Rated Power Consumption	150 W	• Outward Dimension	Width 260 mm Length 194 mm Height 413 mm
• RPM	43 rpm	• Rated Operating Hour	Less than 30 minutes

Warranty

● Product name	● Customer name	● Model name
● Supplier	● Date of purchase	
● Address	● Manufacture's serial number	

Important: For better protection of your purchase, fill out and mail this form to a local distributor where you purchased the appliance and keep the original receipt.

This certifies that the Hurom Slow juicer is covered under warranty by **HUROM** to be free from defects in material construction and workmanship.

Hurom provides warranty for ten (10) years for the motor and two (2) years for other parts from the date of purchase by the original purchaser. Coverage is valid only with proof of purchase from an Authorized Local Distributor. (No international warranty available)

This warranty does not apply to damages caused by accident, misuse, abuse, commercial use, alteration, failure to follow operating instructions, or damage caused by parts or service unauthorized by **HUROM**. Damages caused by transportation must be claimed with carrier.

HUROM disclaims all responsibilities for consequential damages from incidental losses caused by use of this appliance.

Please check the bottom of your Hurom product for a sticker with a barcode. This barcode sticker helps verify a genuine Hurom product and identify the product manufacturing date. Hurom's manufacturer's warranty does not cover products with missing or damaged barcode stickers. Products are to be inspected upon receipt.

For service and assistance with technical difficulty, please contact our local customer service center.

HUROM Manufacture : **HUROM**
Hurom webpage : www.hurom.com