



# THREE-PHASE HYBRID INVERTER

H8000H-EU/H10000H-EU/H12000H-EU



## User Manual



Dongguan Hinen New Energy Technology Co., Ltd

Add: No.24 Dongkang Road, Dalingshan Town, Dongguan City, Guangdong Province, China

Tel: +86 (769) 8992 0666

Email: [market@hinen.com](mailto:market@hinen.com)

Website: <https://www.hinen.com>

## About This Manual

The manual mainly describes the product information, guidelines for installation, operation and maintenance. The manual cannot include complete information about the photovoltaic (PV) system. The reader can get additional information about other devices at <https://www.hinen.com> or on the webpage of the respective component manufacturer.

## Validity

This manual is intended for: This manual is valid for the following inverter models:

- **H8000-EU**
- **H10000-EU**
- **H12000-EU**

They will be referred to as inverter hereinafter unless otherwise specified.

## Target Group

- qualified personnel who are responsible for the installation and commissioning of the inverter; and
- inverter owners who will have the ability to interact with the inverter.

## How to Use This Manual

Read the manual and other related documents before performing any work on the inverter.

Documents must be stored carefully and be available at all times.

Contents may be periodically updated or revised due to the product development. It is probably that there are changes of manual in the subsequent inverter edition. The latest manual can be acquired via visiting the website at <https://www.hinen.com>

## Disclaimer

**Inverters need to be transported, used and operated under suitable environmental and electrical conditions. In the following cases, the manufacturer reserves the right not to provide after-sales service or assistance:**

- The inverter was damaged during transportation.
- Inverter is out of warranty, or extended warranty not purchased.
- Install or use the inverter under improper environmental or technical conditions without authorization from the manufacturer.
- Install or configure the inverter in violation of the requirements mentioned in the user manual.
- Install and operate the inverter in violation of the requirements or warnings mentioned in this user manual.
- The inverter is damaged by any force majeure such as lightning, earthquake, fire, storm and volcanic eruption.
- Disassemble, change or update the software or hardware of the inverter without the authorization of the manufacturer.
- The inverter is installed, used or operated in violation of any international policies and regulations or local policies and regulations.
- Connect any incompatible batteries, loads or other devices to the inverter system.

### Note

- The manufacturer reserves the right to interpret all content in this user manual. In order to protect the IP65 protection level, the inverter must be well sealed, and the unused terminals/holes are forbidden to be opened. Make sure that no water or dust enters the terminals/holes.
- It is only suitable for professionals who are familiar with local regulations, standards and electrical systems, and who have undergone professional training and are familiar with the relevant knowledge of this product.
- Handle this product with care, and store it in a dry and cool room when not in use.

## Safety and Warnings

The inverter strictly abide by the relevant safety regulations for product design and testing. During installation, operation or maintenance, please carefully read and follow all instructions and precautions in the inverter or user manual, any improper operation may cause personal or property damage.

## Symbol Definition and Explanation



Warning!  
Failure to follow the warning signs in this manual could result in personal injury.



High voltage and electric shock hazard!



Hot surface!



Product components are recyclable.



This side up! Arrows must always point upwards during transport, handling and storage.



Do not stack more than six layers.



Disposal as domestic rubbish is prohibited.



Fragile – Handle packaging or product with care and never let it up side down or hang.



See operating instructions.



Stay dry! Please store product in a dry and protected place, avoid excessive moisture.



After the inverter is powered off, there is a delay in the discharge of internal components. Please wait for 5 minutes until the device is fully discharged.



CE mark

## Safety warning

Any installation and operation must be carried out by a qualified electrician in accordance with local grid or company standards, wiring rules or requirements (such as AS 4777 and AS/NZS 3000 in Australia).

Before doing any wiring or electrical work on the inverter, all batteries and AC power must be disconnected from the inverter for at least 5 minutes to ensure that the inverter is completely isolated to avoid electric shock.

The surface temperature of the inverter cannot be too high during operation, so please make sure it has cooled down before touching it, and keep the inverter stay far away from children.

Do not open the inverter replace any parts without the authorization of the manufacturer, otherwise the warranty commitment of the inverter will be invalid.

Please follow the instructions in this user manual to use and operate the inverter, otherwise it may affect the protection design of the inverter and invalidate the warranty commitment of the inverter.

Please take appropriate measures to protect the inverter from static electricity damage, the manufacturer is not responsible for any damage caused by static electricity.

The PV negative (PV-) and battery negative (BAT-) on the inverter side are not grounded by default, do not ground their negatives.

The photovoltaic modules used on the inverter must meet the IEC61730A level, and the total open circuit voltage of the photovoltaic string/array is lower than the maximum rated DC input voltage of the inverter. Any damage caused by photovoltaic overvoltage is not covered by the warranty.

In Australia, the neutral line of the internal switch of the inverter is incomplete, and an external connection needs to be added.

In Australia, the output terminal on the off-grid side of the distribution box shall be marked "main switch EPS power supply"; and the output terminal on the common load side in the distribution box shall be marked "main switch inverter power supply".

# Contents

## 1. Introduction

1.1 Introduction to operating modes	2
1.2 Product introduction	2
1.3 Specifications parameters	4

## 2. Installation descriptions

2.1 Example of wrong installation	7
2.2 System Wiring Diagram	8
2.3 Packing list	11
2.4 Installation	12
2.4.1 Installation tools	12
2.4.2 Select mounting location	13
2.4.3 Mounting inverter	15
2.5 Electrical connections	16
2.5.1 Connect the PV input line	16
2.5.2 PV wiring connection	17
2.5.3 Connect the battery cable	19
2.5.4 Battery wiring connection process	19
2.5.5 On-grid & Off-grid connection	22
2.5.6 Requirement of AC cable connected to On-grid and Off-grid side	22
2.5.6.1 Off-grid connection	23
2.5.6.2 On-grid connection	25
2.5.7 Connect smart meter	29
2.5.8 Smart meter use	29

2.6 Connection ground fault alarm	32
2.6.1. Inverter ground fault	32
2.6.2. External inverter ground faults	32
2.7 Way of battery terminal wiring	32
2.7.1 Battery connection mode	32
2.8 Connect WIFI module	34
2.8.1 Stick logger installation	34
2.8.2 Logger status	35
2.8.3 Abnormal state processing	36
2.9 The connection mode of COM	37

## 3. Commissioning

3.1 Inspection before commissioning	39
3.1.1 Connection check	39
3.1.2 Electrical inspection	41
3.2 Powering on the system	43
3.2.1 Boot steps	43
3.3 Shutting down the system	44

## 4. App

4.1 Internet connection	45
4.2 App preparation	45
4.2.1 Download & use the app	45
4.2.2 User registration	46
4.3 Plant creation	47
4.4 Add a logger	48
4.5 Device networking	50
4.6 Observe the running status of the device	52

4.7 View the system information and parameters	54
4.8 Settings	62
4.8.1 Common settings	62
4.8.2 Other settings	72
4.9 Trouble codes	89
4.9.1 Fault reference code	89
4.9.2 Warning reference code	91
4.10 Troubleshoot	93

## 5. Other

5.1 Fault details	98
5.2 Hazard avoidance quick checklist	100
5.3 Maintenance	101
5.3.1 Maintenance details	101
5.3.2 Daily maintenance	102

## 1. Introduction

The inverter is called hybrid or bidirectional solar inverter and is suitable for solar systems with participation of PV, battery, loads and grid system for energy management. The energy generated by the photovoltaic system can be used to optimize the structure of household electricity consumption, the excess energy is used to charge the battery, and the remaining energy is exported to the grid. When the photovoltaic energy is not enough to meet the self-use demand, the battery should be discharged to support the load. If the battery is low, the load will be powered by the grid.

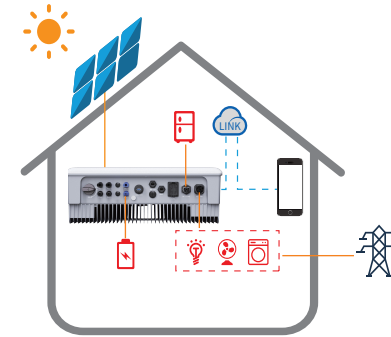

Schematic diagram of the photovoltaic energy storage inverter:

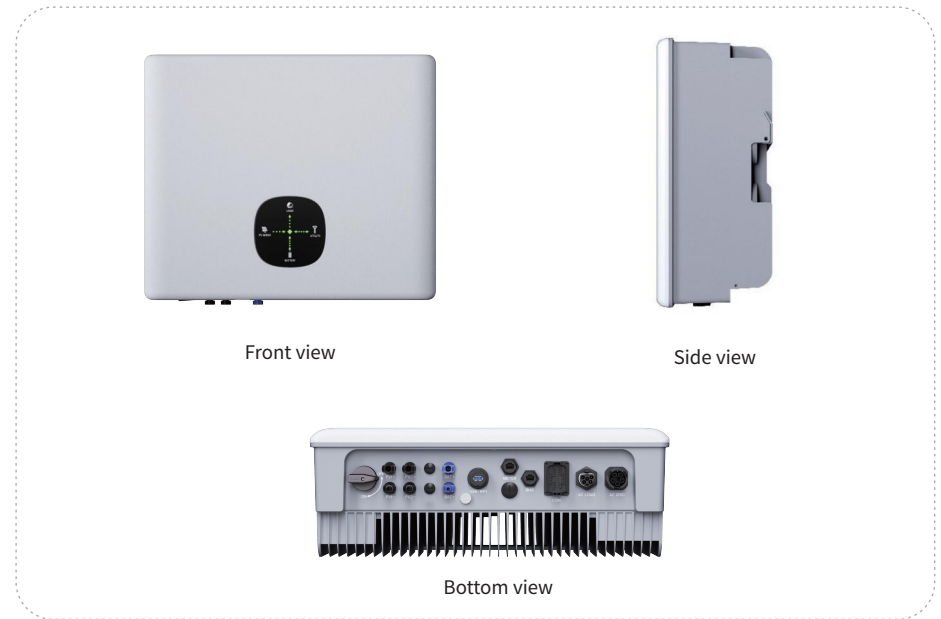

The product introduction section introduces the common working conditions of the inverter system. Users can adjust the inverter operation mode according to the system layout on the SOLARMAN Smart APP.

## 1.1 Introduction to operating modes

According to different system configurations and layouts, the inverter can usually be set to the following operating modes.

Mode 1

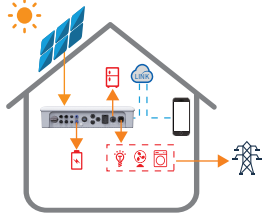

The energy generated by the photovoltaic system is mainly used for self-consumption, the excess energy is used to charge the battery, and the rest is output to the grid.

Mode 2

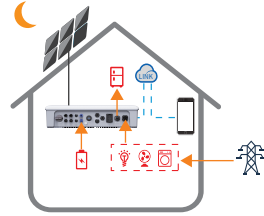

When the photovoltaic side does not input energy and the battery is fully charged, the battery and the grid will supply power to the load at the same time.

Mode 3

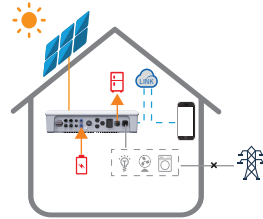

When the grid is powered off, the system automatically switches to the back-up mode, and the photovoltaic side and the battery side can supply power for the back-up load.

Mode 4

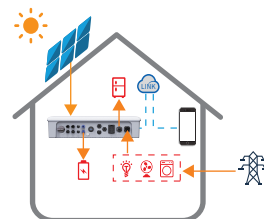

The grid and photovoltaic system can supply power to the load and charge the battery, and the charging time and power can be set through the SOLARMAN Smart software.

## 1.2 Product introduction

### Light Board Display Mode Description

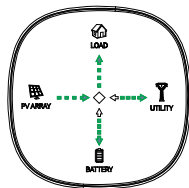

Light Board Display :  
Mode 1

The energy generated by the photovoltaic system is mainly used for self-consumption, the excess energy is used to charge the battery, and the rest is output to the grid.

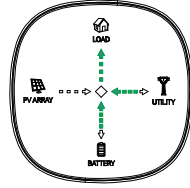

Light Board Display :  
Mode 2

When the photovoltaic side does not input energy and the battery is fully charged, the battery and the grid will supply power to the load at the same time.

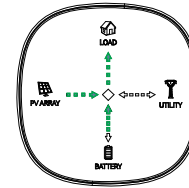

Light Board Display :  
Mode 3

When the grid is powered off, the system automatically switches to the back-up mode, and the photovoltaic side and the battery side can supply power for the back-up load.

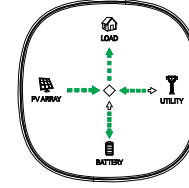

Light Board Display :  
Mode 4

The grid and photovoltaic system can supply power to the load and charge the battery, and the charging time and power can be set through the SOLARMAN Smart software.

### Port Diagram

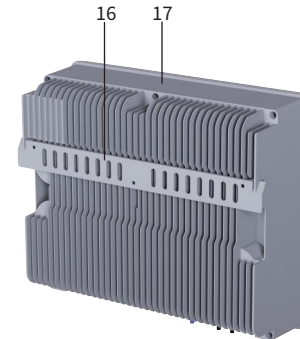
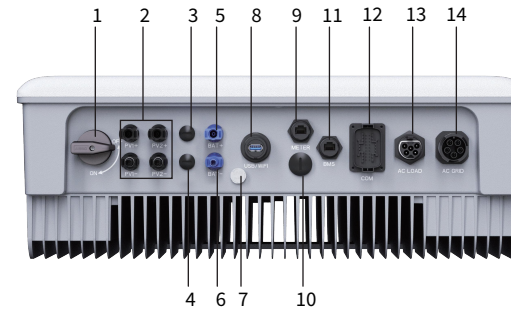

- |                                       |
|---------------------------------------|
| 1. PV switch                          |
| 2. PV Input terminal (PV1/PV2)        |
| 3. Reserved port (not used)           |
| 4. Reserved port (not used)           |
| 5. Battery positive input port        |
| 6. Battery Negative Input Port        |
| 7. Waterproof breathable valve        |
| 8. USB port (WiFi connection port)    |
| 9. METER port (smart meter interface) |
| 10. Reserved port (not used)          |
| 11. BMS port                          |
| 12. COM port (485 port/DRMS signal)   |
| 13. Off-grid port                     |
| 14. Grid-connected port               |
| 15. LED indicator board               |
| 16. mounting plate                    |
| 17. heat sink                         |

### 1.3 Specifications parameters

Model	H8000H-EU	H10000H-EU	H12000H-EU
<b>PV Input data</b>			
Max. recommended PV power	12000W	15000W	18000W
Max. DC voltage	1000V		
Start Voltage	120V		
MPP voltage range	140V-950V		
Nominal voltage	600V		
Number of independent MPPT	2		
Maximum number of input strings for MPPT	1/1		
Max. input current per string	16A/16A		
Max. short-circuit current per MPPT	22A/22A		
Backfeed current to the array	0A		
<b>BAT data</b>			
Type of battery	lithium ion battery		
Battery voltage range	120V~600V		
Nominal Battery voltage	500V		
Max charging and discharging current	45A		
Max charging and discharging power	8000W	10000W	12000W
Charging strategy	BMS instructions		
<b>AC data(grid-connected)</b>			
Rated AC output power	8000W	10000W	12000W
Max AC output apparent power	8800VA	11000VA	12000VA
Max AC input apparent power	16000VA	16000VA	16000VA
AC nominal voltage range	400V/230V, 380V/220V, 3L/N/PE		
AC nominal frequency	50/60Hz		
Max. AC output current	13.4A	16.7A	18.2A
Max. AC input current	24.3A	24.3A	24.3A
Power factor	~1(0.8leading - 0.8lagging)		

THDI @Full load	<3%		
AC inrush current	32A		
MAX. output overcurrent protection	56A		
AC maximum output fault current	56A		
<b>AC Output(Off-grid)</b>			
Rated AC output power	8000W	10000W	12000W
Max AC output apparent power	8800VA	11000VA	12000VA
Peak AC output power	16000 VA,10s	16000 VA,10s	16000 VA,10s
AC nominal voltage range	400V/230V, 380V/220V, 3L/N/PE		
AC nominal frequency	50/60Hz		
Max AC output current	13.4A	16.7A	18.2A
THDV @Linear load	<3%		
<b>Efficiency</b>			
Maximum efficiency	97.6%		
European efficiency	97%		
Max Battery discharge efficiency	97.0%		
MPPT efficiency	99.9%		
<b>Protection</b>			
DC switch	yes		
PV reverse polarity protection	yes		
BAT reverse protection	yes		
Output AC overcurrent protection	yes		
Output AC overvoltage Protection	yes		
Anti-islanding protection	yes (Active Frequency Drift)		
Residual current detection	yes		
Insulation resistance detection	yes		
surge protection	II (DC)/III (AC)		
<b>General Data</b>			
Topology	Transformerless		

Dimensions(W/H/D)	538*452*195mm
Weight	28.5kg
Protective Class	Class I
Installation	Wall mounted
Operating temperature range	-25~60°C
Relative humidity (Non-condensing)	0~100%
Altitude	≤4000m
Cooling	Free cooling
noise	<40dB
Protection class	IP65
<b>Features</b>	
DC connection	MC4
AC connection	5P Connector
Display	LED+APP
Monitor	RS485 / WIFI / GPRS
Warranty	5 years /10 years(optional)
<b>Certification</b>	
Safety	IEC/EN 62109-1, IEC/EN 62109-2, EN 62477-1:2022, IEC 60529
EMC	IEC/EN 61000-6-2, IEC/61000-6-4, IEC/EN 61000-2-2, CISPR11
Grid-connected	VDE 4105, AS 4777.2, EN 50549-1, EN 50438, RD 1699, RD 413, RD 647, UNE 217001, UNE 217002, NTS SEPE:2021, NRS-097, NC RfG:2016, PSE:2018, PTPiREE:2021

## 2. Installation descriptions

### 2.1 Example of wrong installation

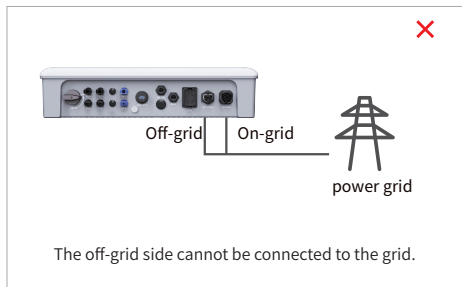
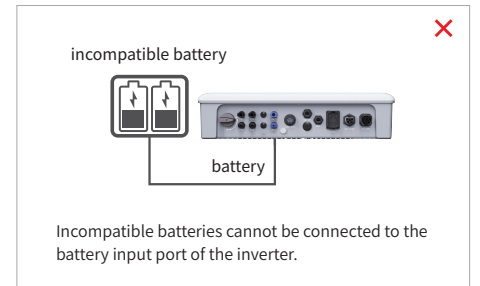
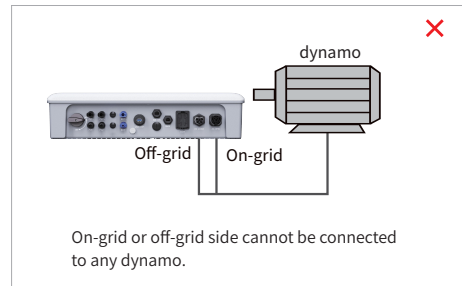
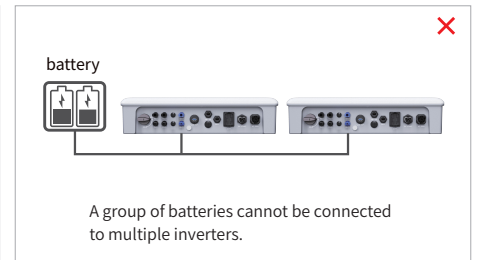
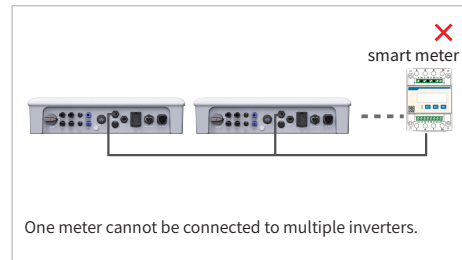
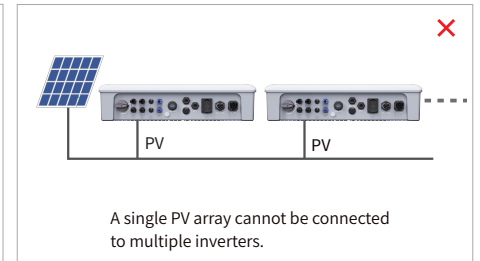
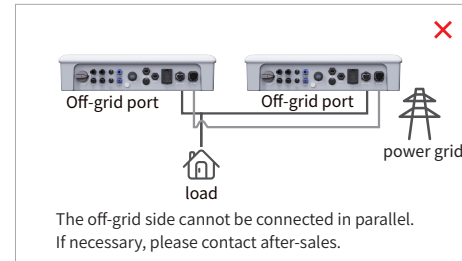



## 2.2 System Wiring Diagram

### The energy storage inverter wiring system

Select a circuit breaker according to the following specifications:

Inverter	①	②	③	④	⑤
The 12K inverter	60A/650V DC circuit breaker	32A/400V AC circuit breaker	32A/400V AC circuit breaker	Depending on load	Depending on load

1. For batteries with circuit breaker, the external DC circuit breaker can be omitted.
2. Only for lithium batteries with BMS communication.
3. The direction of CT cannot be reversed, and the direction of current points to the inverter.

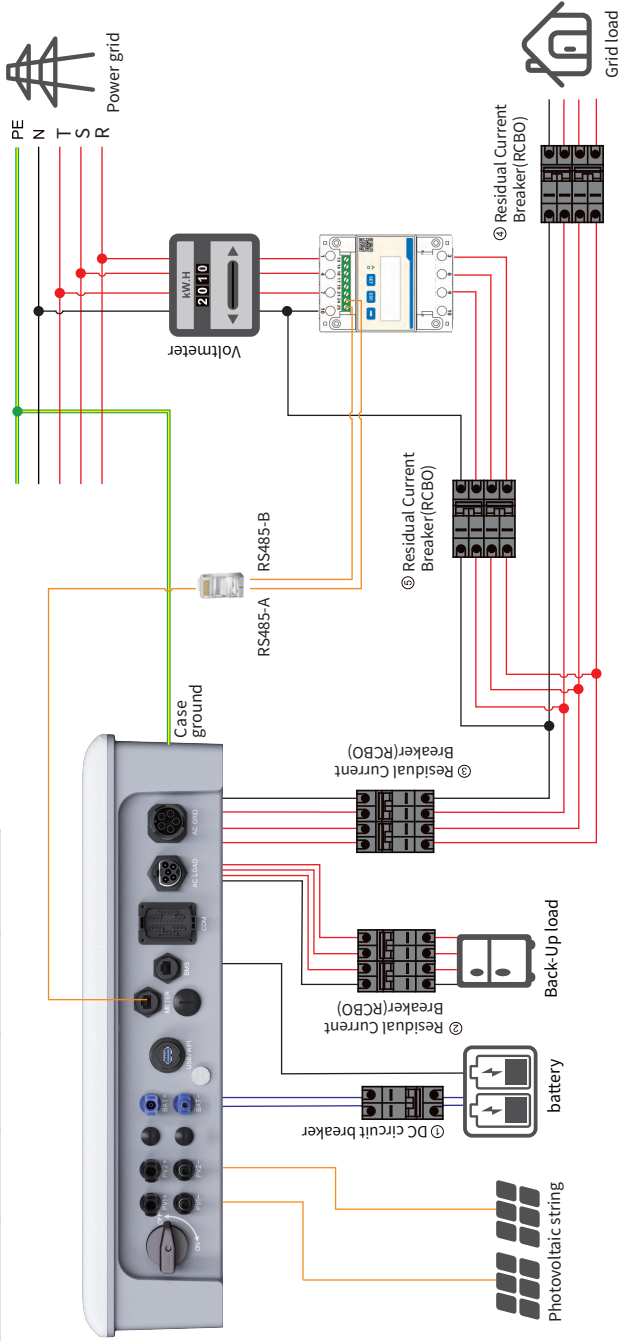

**Note:** This picture is the wiring structure diagram of the energy storage inverter, not the electrical wiring standard.

### System Wiring Diagram

**Note:** According to Australian safety regulations, the neutral wires of the grid-connected side and the off-grid side must be connected together, otherwise the off-grid function cannot be used normally.

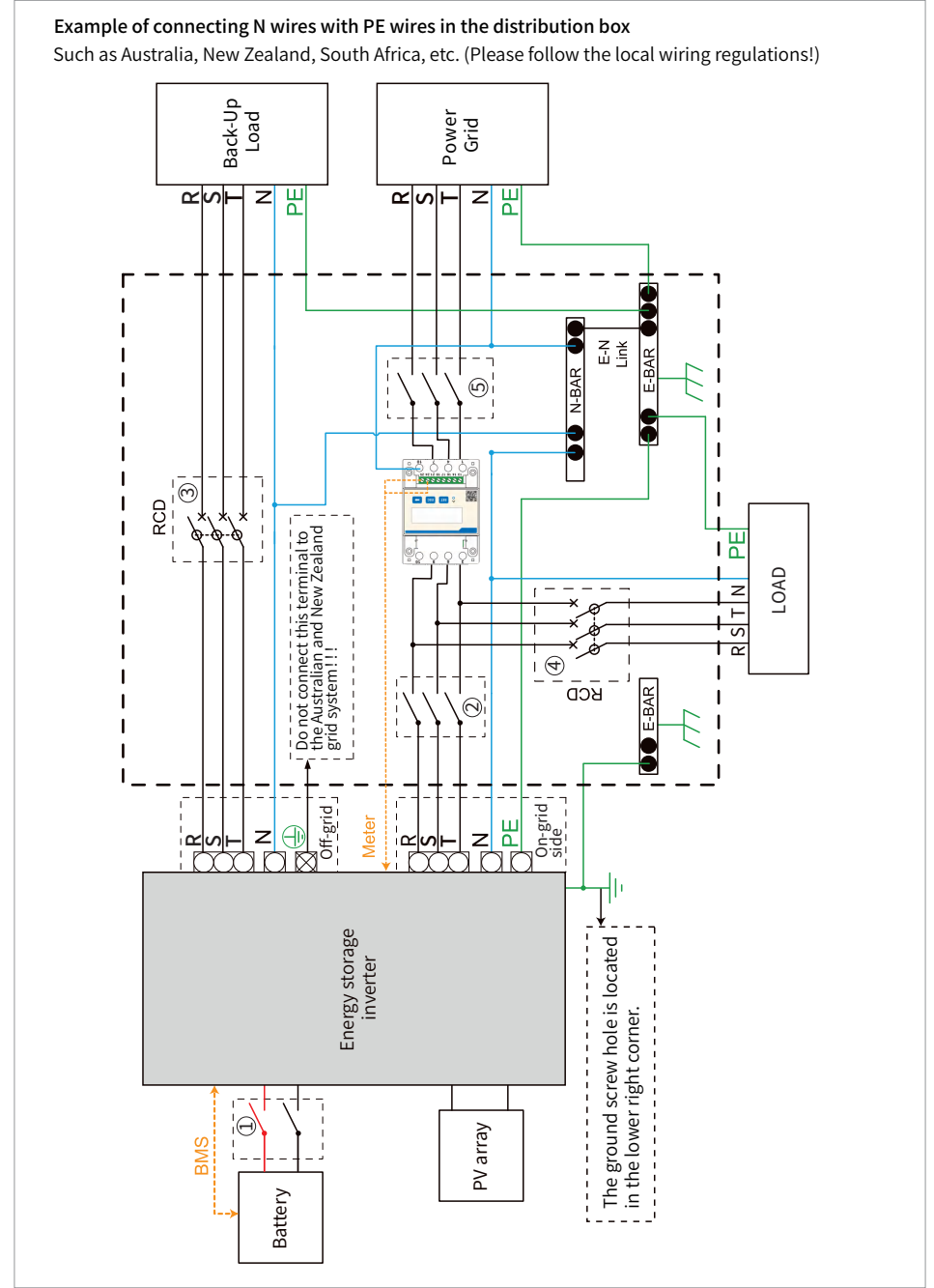

### Schematic representation of grid systems with no special requirements for electrical connections

**Note:** the off-grid ground wire and ground bar must be properly connected to work properly. Otherwise, the off-grid function may be abnormal when the grid fails.

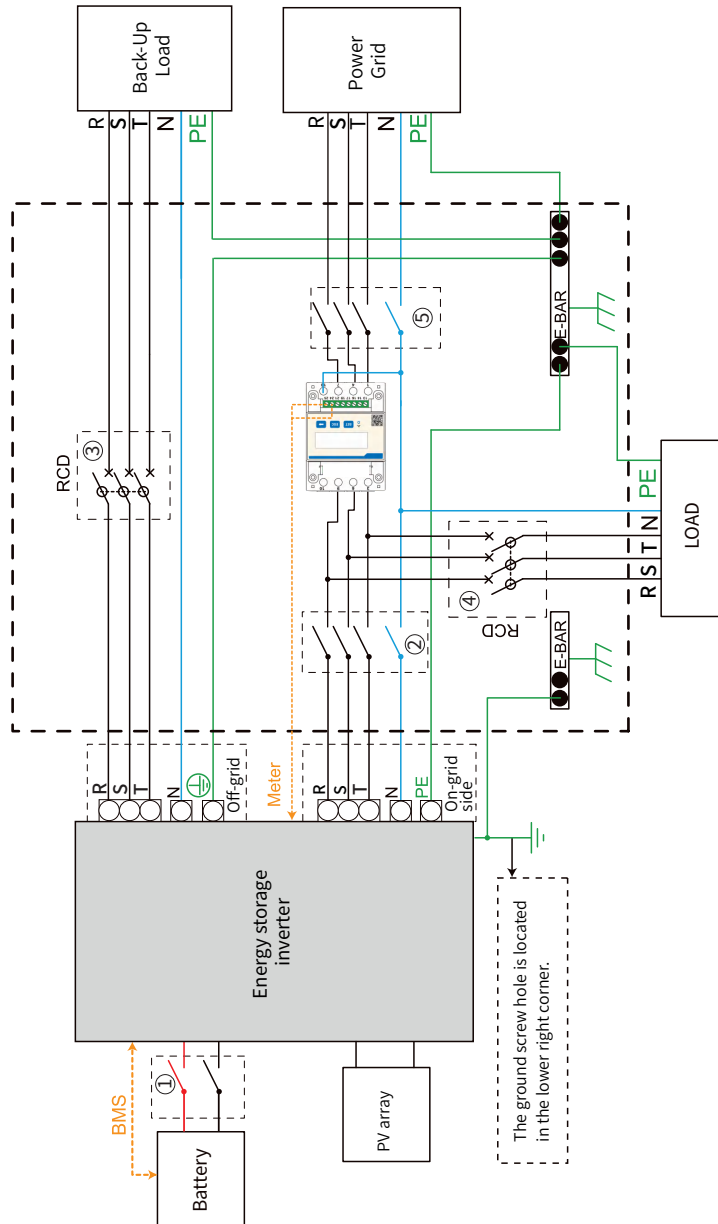

Model	①	②	③	④	⑤
H8000H-EU	60A, $\geq 650V$ DC breaker	32A/400V AC breaker	32A/400V, 3L/N/PE 30mA RCD (Type A)	30mA RCD (Type A), Depending on load	main breaker
H10000H-EU	60A, $\geq 650V$ DC breaker	32A/400V AC breaker	32A/400V, 3L/N/PE 30mA RCD (Type A)	30mA RCD (Type A), Depending on load	main breaker
H12000H-EU	60A, $\geq 650V$ DC breaker	32A/400V AC breaker	32A/400V, 3L/N/PE 30mA RCD (Type A)	30mA RCD (Type A), Depending on load	main breaker

#### Note:

- If the battery has integrated a readily accessible internal DC breaker, then no additional ① DC breaker is required.
- The use of ③④ 30mA RCD is recommended but not mandatory, please comply with local regulations for the system installation.

### 2.3 Packing list

Upon receiving the hybrid inverter, please check if any of the components as shown below are missing or broken

Inverter x1	Wall Mount Bracket x1	Black PV positive Connector x2	Black PV negative Connector x2	Blue positive battery Connector x1
Blue negative battery Connector x1	Smart Meter x1	AC Load Connector x1	GRID Connector x1 Phillips Screws x4 Protective Cover x1	Screw x3
Expansion screw x3	COM x1	WIFI Module x1	Cord End Terminal x18	User Manual x1 Quick Installation Guide x1

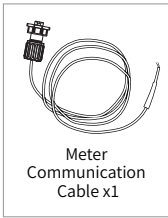

\* The images shown here are for reference. The actual product and quantity are based on delivery.

## 2.4 Installation

### 2.4.1 Installation tools

Recommended installation tools include but are not limited to the following tools. If necessary, additional auxiliary tools can be used on site.

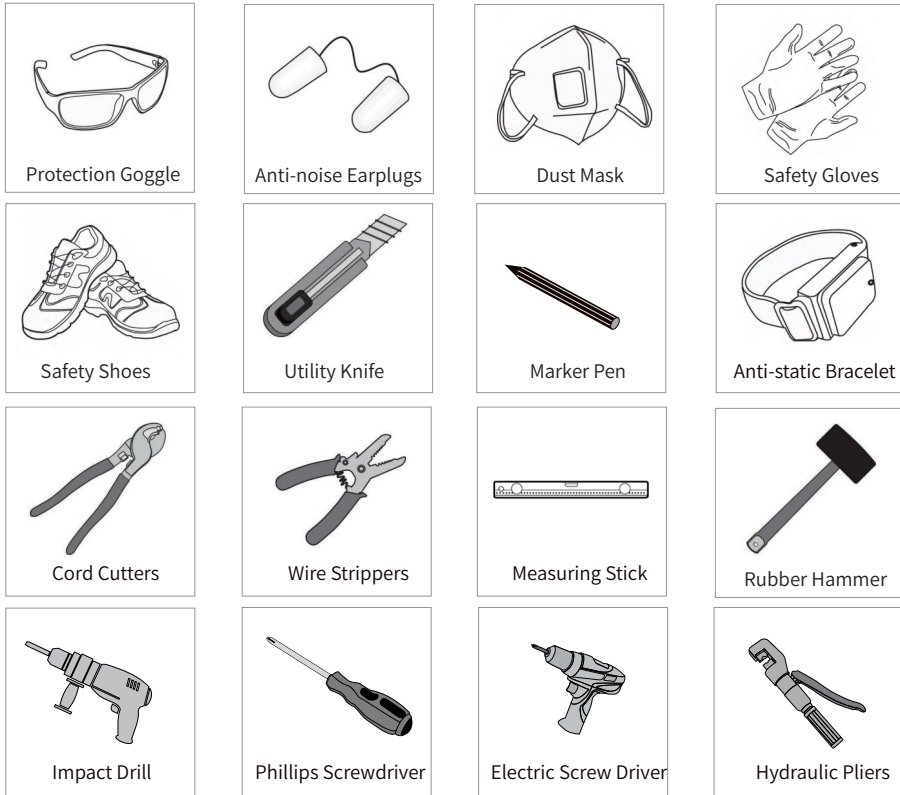

### 2.4.2 Select mounting location

For inverter's protection and convenient maintenance, mounting location for inverter should be selected carefully based on the following rules.

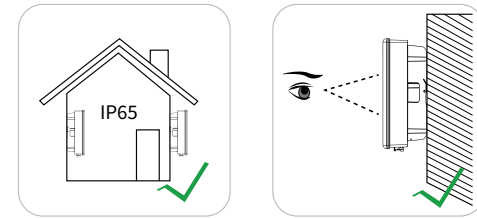

**Rule 1.** The inverter with IP 65 can be installed both indoors and outdoors.

**Warning!** It is recommended that the installation of the inverter should be prevented from direct sunlight, snow, rain and other negative influences which may cause function impact or life aging.

**Rule 2.** Install the inverter in a convenient place for electrical connection, operation, and maintenance. Any part of this system shouldn't block the switch and breaker from disconnecting the inverter from DC and AC power.

**Rule 3.** Inverter should be installed at eye level for convenient maintenance.

**Rule 4.** Product label on inverter should be clearly visible after installation. Do not damage the label.

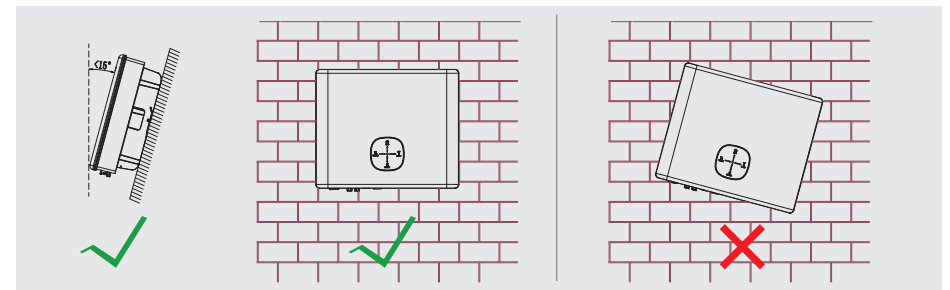

**Rule 5.** Inverter should be installed vertically with a max rearward tilt of 15°.

**Rule 6.** Ambient temperature should be lower than 45°C. (Too high ambient temperature will de-rate the inverter's power efficiency).

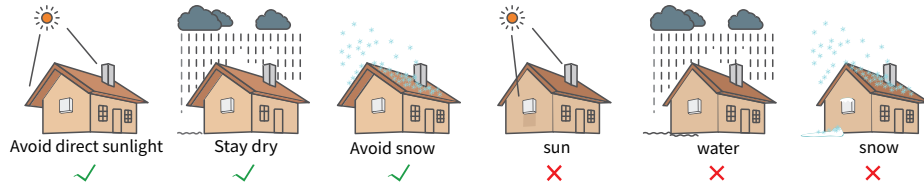

**Rule 7.** The mounting structure where the inverter is installed must comply with local/national standards and guidelines. Ensure that the installation surface is solid enough to bear four times the weight of the inverter (e.g. cement walls, plasterboard walls, etc.).

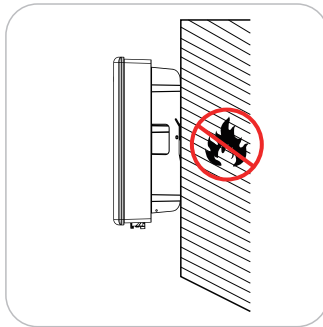

**Rule 8.** Leave enough space around the inverter according to the below figure for natural heat dissipation.

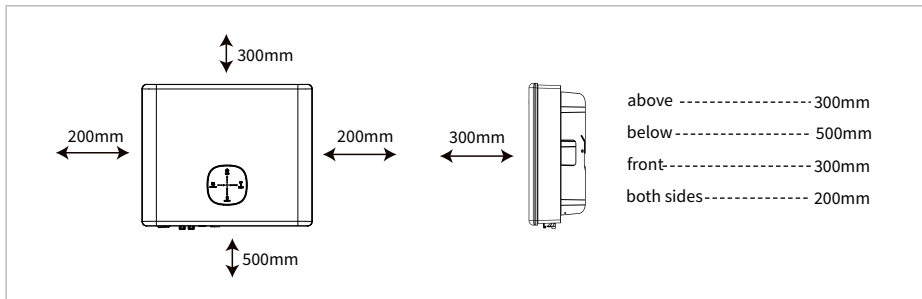

**!** The inverter must not be installed near flammable or explosive materials or near equipment with strong electromagnetic fields.

**!** Remember that this inverter is heavy! Please be careful when lifting out from the package. The inverter is suitable for mounting on concrete or other non-combustible surfaces only.

### 2.4.3 Mounting inverter

**!** The product is heavy, please take it out of the package carefully.

The inverter is only suitable for installation on non-combustible solid surfaces such as concrete.

- 1 The wall hanging is placed horizontally on the installation wall, and the marker pen is used as a punching mark.
- 2 Use a percussion drill to drill a diameter of 8mm according to the marked point, Holes with a depth of 60mm.

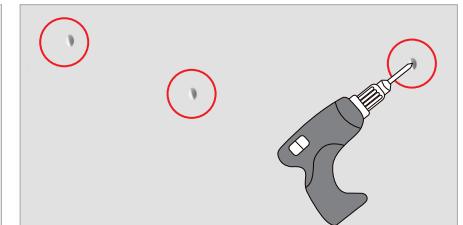
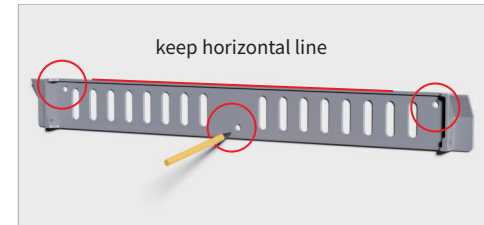

- 3 Put the expansion tube into the wall hole, and use the standard self-tapping screws to install and lock the wall hangings.
- 4 Two people are required to hang the inverter on the wall mount.

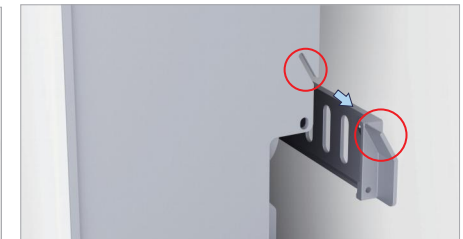
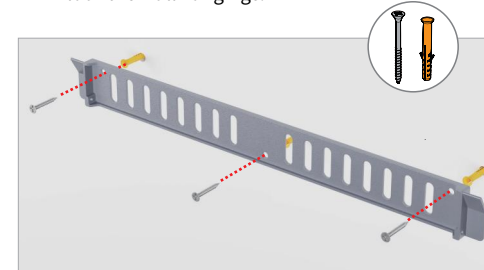

- 5 Use the standard anti-theft screws to lock both sides of the wall hanging.



## 2.5 Electrical connections

### 2.5.1 Connect the PV input line

Connect the PE cable to the grounding plate at the grid side.

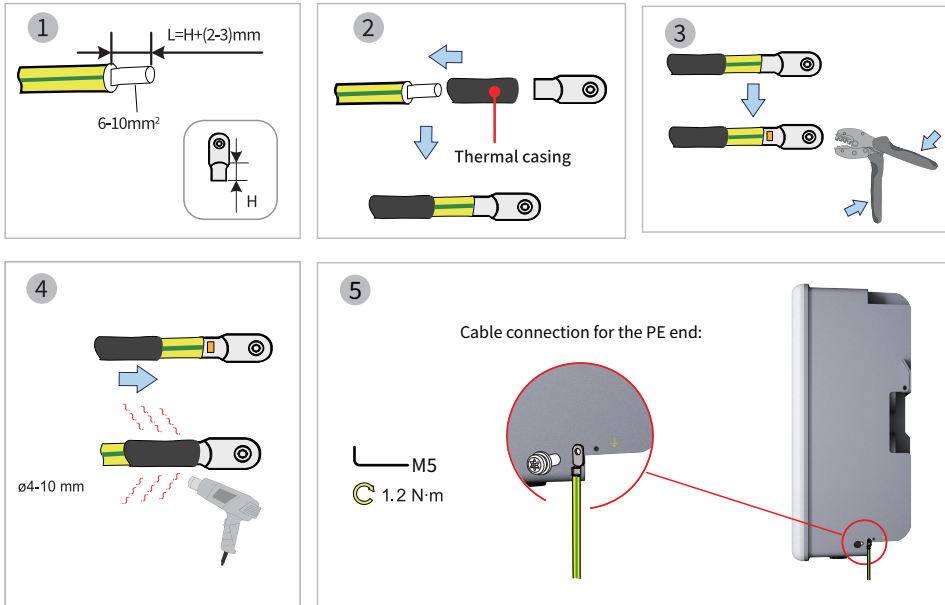

**Note:** All non-current carrying metal parts and device enclosures in the PV power system should be grounded.

### 2.5.2 PV wiring connection

Before connecting PV panels/strings to the inverter, please make sure all requirements listed below are followed.

1. The total short-circuit current of a PV string must not exceed the inverter's max DC current.
2. The minimum impedance to earth of the PV module shall be greater than  $19.33\text{k}\Omega$ .
3. The PV string must not be connected to the earth/grounding conductor.
4. If the inverter is integrated with a PV switch, please make sure it is in the "OFF" position. Otherwise please use an external PV switch to cut off the PV connection during wiring and when necessary.
5. Use the PV plugs in the accessory box for PV connections. Damage to the device due to the use of an incompatible terminal shall not be covered by the warranty.
6. BAT plugs are similar to PV plugs. Please make sure the connectors are correct before using them.

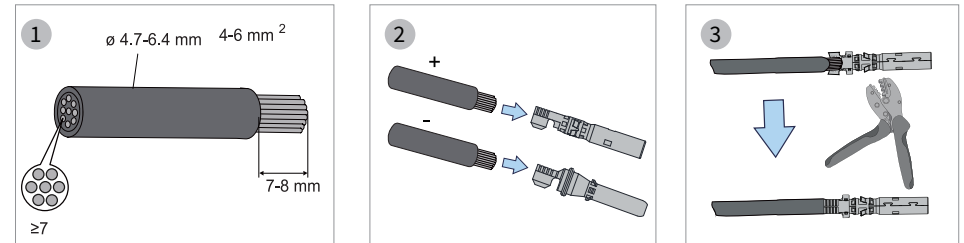

- Strip the insulation from each DC cable by 7-8 mm.
- The conductor cross-sectional area:  $4-6\text{mm}^2$ .
- Assemble cable ends with crimp contacts by PV terminal crimping tool.

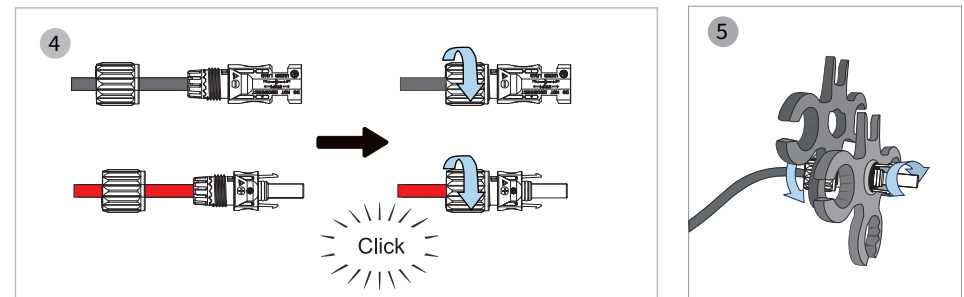

- Lead the cable through the cable gland, and insert the crimp contact into the insulator until it snaps into place.
- Tighten the cable gland and the insulator.
- Gently pull the cable backward to ensure a firm connection.

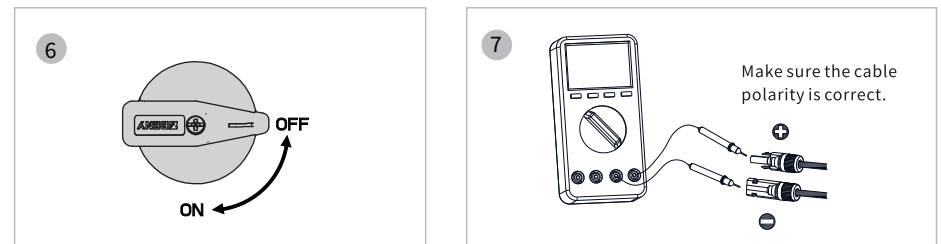

- Check the cable connection of the PV string for polarity correctness and ensure that the open-circuit voltage in any case does not exceed the inverter input limit of 950V.

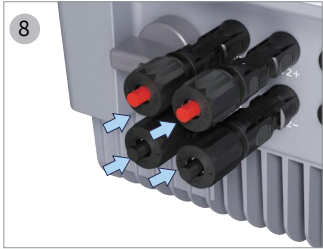

**Note:** You will hear a sound when the connector is inserted into the PV terminal.

**Warning:** The polarity of the PV strings must not be connected in a reverse manner. Otherwise, the inverter could be damaged.

#### Remove the PV plugs

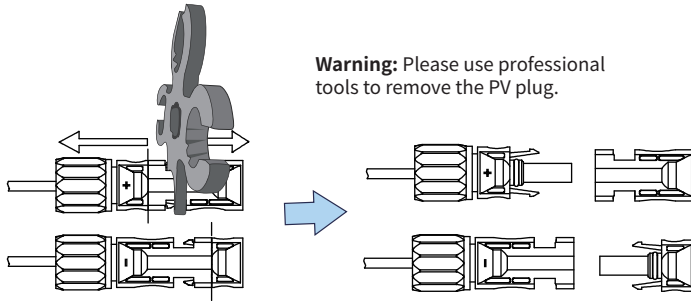

**Warning:** Please use professional tools to remove the PV plug.

#### Notice:

If the PV port is not used, install a dust cap to prevent rain and dust from entering the inverter.

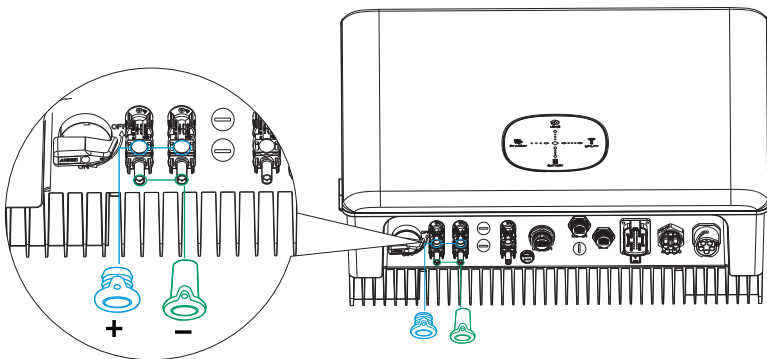

### 2.5.3 Connect the battery cable

Be aware of electrical shock hazards or chemical hazards. If the battery does not have a built-in DC circuit breaker, please ensure that an external DC circuit breaker ( $\geq 60A$ ) is connected.



Before connecting the battery to the inverter, please make sure the circuit breaker is off and the nominal voltage of the battery meets the specifications of the inverter. Make sure the inverter is completely isolated from PV and AC power.

Lithium battery (pack) capacity should be at least 50Ah. It is recommended to use 7AWG wire for the battery cable.



Part	Description	Value
A	Insulation outer diameter	3.5-4.2mm
B	Insulation parts	/
C	Cross-sectional area of conductor core	10.5-13.3mm <sup>2</sup>
D	Allowable current	45A

### 2.5.4 Battery wiring connection process

Prepare battery cables and accessories.

#### Note

- Use the BAT plugs in the accessory box for battery connections. Damage to the device due to the use of an incompatible terminal shall not be covered by the warranty.
- BAT plugs are similar to PV plugs. Please make sure the connectors are correct before using them.
- Make sure the polarity (+/-) of the battery is not reversed. If no battery is configured, it will not work Back-up function.

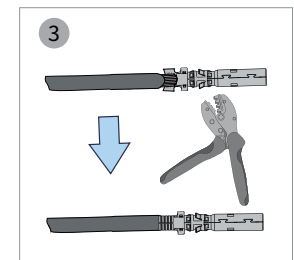
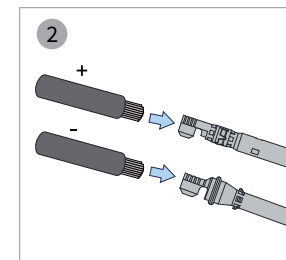
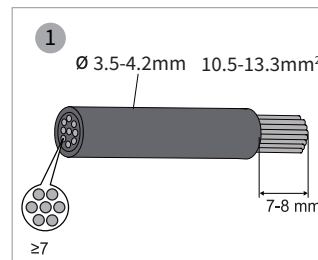

- Peel off the cable sheath to expose a 7-8mm long metal core.
- The cross-sectional area of the conductor is approximately 10.5mm<sup>2</sup>.
- Use a special crimping tool to crimp the crimping terminal

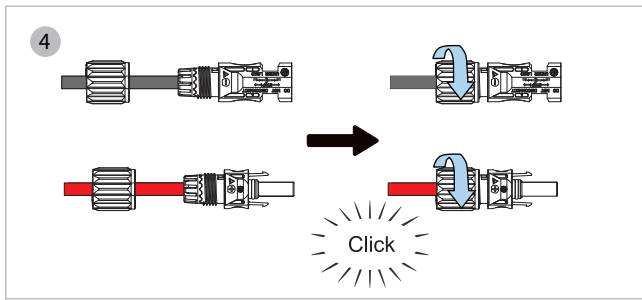

• Thread the cable through the cable gland and insert the crimp contact into the insulator. A clicking sound is heard to indicate that it has snapped into place.

• Tighten the cable gland and insulator using the MC4 wrench.

• Gently pull back on the cable to ensure a secure connection.

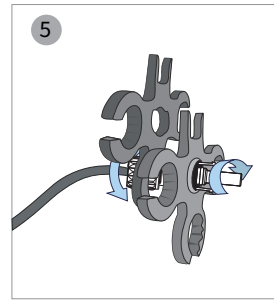

**Note:** Connect the positive and negative battery plugs to the inverter. If connected correctly, it should make a "click" sound.

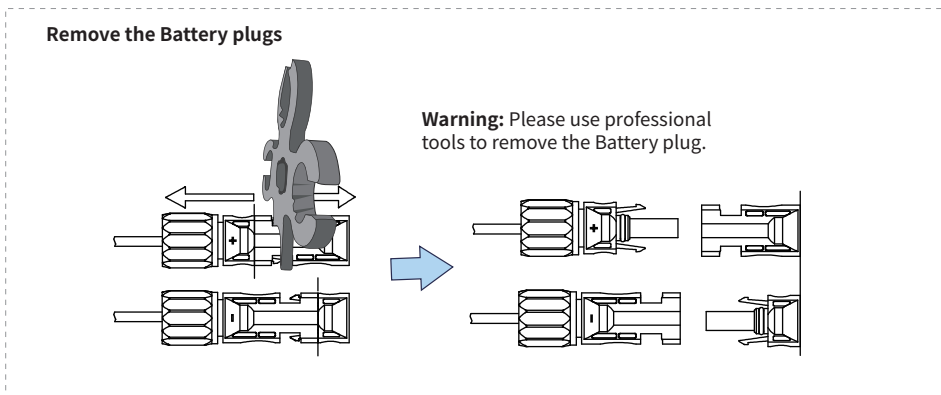

#### Remove the Battery plugs

**Warning:** Please use professional tools to remove the Battery plug.

#### Notice:

If the battery port is not used, install a dust cap to prevent rain and dust from entering the inverter.

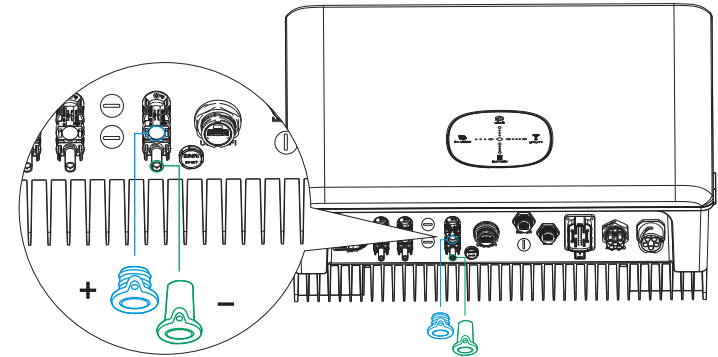

\* For connection of compatible lithium batteries (High-voltage batteries of the same series), refer to the battery manual and this product description for 2.7 Battery connection method.

#### Battery protection

**Under any of the following conditions, the battery will limit the charge/discharge current for protection.**

- Battery SOC is lower than I-DOD (depth of discharge).
- The battery voltage is lower than the discharge voltage.
- Battery Overheating Protection.
- Abnormal battery communication of lithium battery.
- Lithium battery BMS limit.

**When the current limit protection occurs:**

- In grid-connected mode, battery charging and discharging operations may be abnormal.
- In off-grid mode, off-grid power will be turned off.

#### Note

• In off-grid mode, if the off-grid power supply is shut down due to battery, battery SOC or low voltage, all the energy generated

by the photovoltaic side will be used to charge the battery until the battery SOC reaches  $20\% + I-(DOD)/2$ , activate off-grid power.

• In grid-connected mode and off-grid mode, the battery is over-discharged protected by DOD and discharge voltage.

• Setting the battery DOD prevents the inverter from discharging battery backup power. Once the DOD set point is reached, the load will only be powered by the PV side or grid support. If the battery has received little or no charge for several days, the battery may continue to drain itself to maintain communication with the inverter. The batteries produced by different battery manufacturers are different, but if the SOC of the battery reaches a certain level, the inverter will cause the SOC to increase. This protection mechanism prevents the battery SOC from dropping to 0%.

## 2.5.5 On-grid & Off-grid connection

When the inverter is connected to the grid, add an external AC circuit breaker to isolate the grid from the inverter if necessary.

The requirements of the grid parallel circuit breaker are as follows.

Inverter mode	AC Breaker Specifications
The 12K inverter	32A/400V (DZ247-60 C32)

\* For details of AC circuit breaker specifications for other inverter types, refer to section 2.2 System Wiring Diagrams.

**Note:** If an electrical short occurs when the off-grid side is not connected to the AC circuit breaker, the inverter may be damaged.

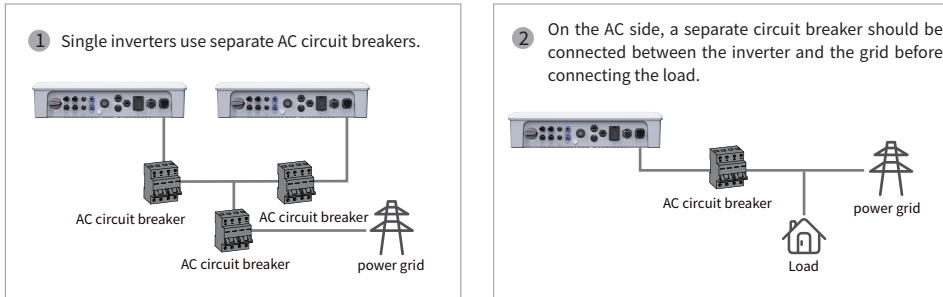

## 2.5.6 Requirement of AC cable connected to On-grid and Off-grid side



Before connecting the AC cables, please ensure that the inverter is completely isolated from the DC or AC power.

1. The N wire is black, the R wire is yellow, the S is green, the T is red, and the protection ground wire is yellow-green.

2. The protective ground wire of the AC cable should be longer than the N wire, R wire, S wire and T wire, so when the AC cable slips or is pulled out, the protective ground conductor can bear the strain last.

Common AC cable specifications are as follows.

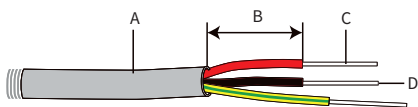

	Description	Value
A	Outer diameter	$\geq 25\text{mm}$
B	Cable length stripped	20-25mm
C	The length of the conductor	7-8mm
D	Conductor cross-sectional area	8.3-13.7mm <sup>2</sup>

## 2.5.6.1 Off-grid connection

The inverter has on-grid and off-grid function. The inverter will transmit power through the AC grid port when the grid is on, and it will transmit power through the AC load port when the grid is off.

Notice :

- Please use the AC load connector in the accessory box. Damage to the unit caused by the use of incompatible connectors is not covered by the warranty.

- Make sure that the AC load power rating is within the AC output power rating of the inverter, or the inverter will shut down with an "overload" warning.

- For non-linear loads, make sure the surge power is within the AC load output power range of the inverter.

- 1 Strip the cable sheath by 20-25mm and the wire insulation by 7-8mm.

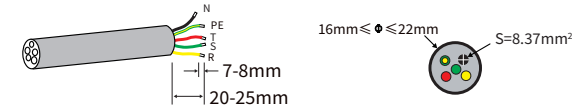

- 2 Unscrew the grid connector counterclockwise, and disassemble the parts in sequence.

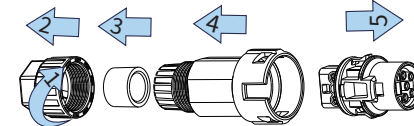

- 3 Insert the cable conductor core into the terminal and crimp. Ensure that the cable sheath is not locked into the connector.

Thread an appropriate length of AC cable through the waterproof terminal.

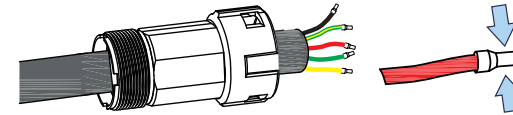

- 4 Secure all cables to the corresponding terminals with a screwdriver at a torque of 2 N·m according to the markings on the connectors.

Assemble the parts in order, making sure to tighten them. Connect the EPS connector to the inverter and tighten it.

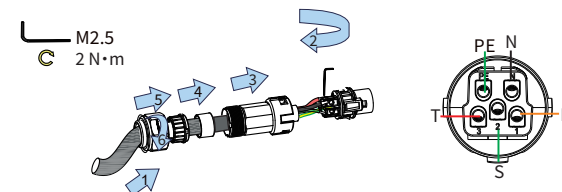



- Align the square opening on the grid terminal with the foot buckle on the inverter grid port and insert. The foot buckle entering the grid terminal and exposing the upper opening followed by a "click" means the connection is correct.



### Remove the off-grid plug

- To remove the grid terminals use a tool to hold down the foot buckle on the inverter grid port so that the square openings on the grid terminals are free from the inverter.

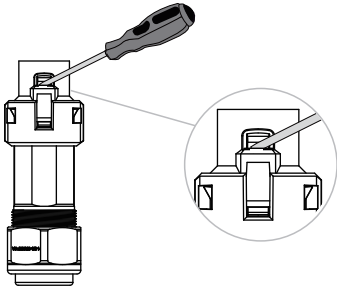

**Warning:** Disconnect power from grid and equipment, and remove grid terminals by professional installer.

- Insert the H type tool and pull it out from the socket.

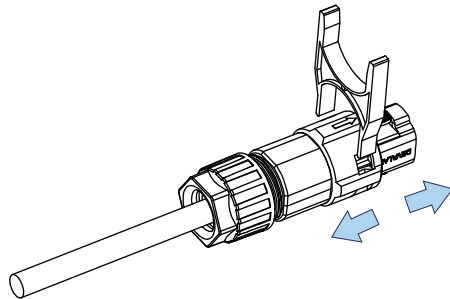

### Notice:

If the off-grid port is not used, please install a dust plug for the AC load connector to prevent rain and dust from entering the inverter.

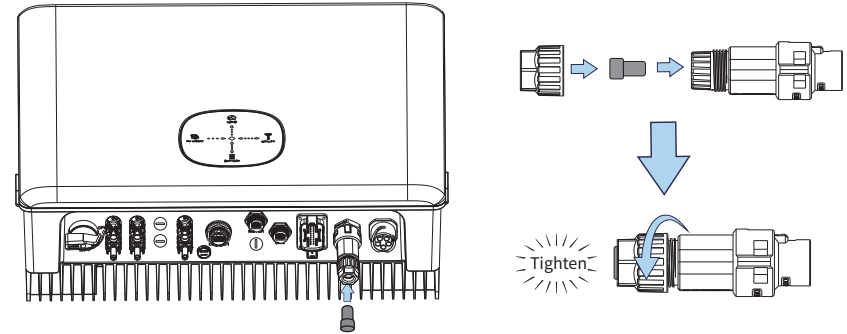

### 2.5.6.2 On-grid connection

**Notice:** Please use the grid connector from the accessory box. Damage to the device due to the use of incompatible connector shall not be covered by the warranty.

- Strip the cable sheath by 20-25mm and the wire insulation by 7-8mm.

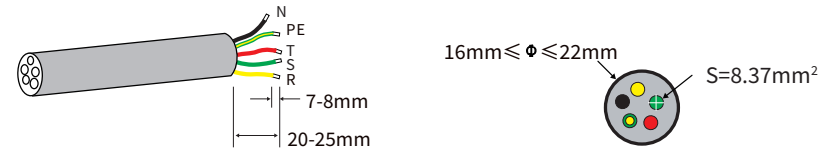

- Unscrew the grid connector counterclockwise, and disassemble the parts in sequence.

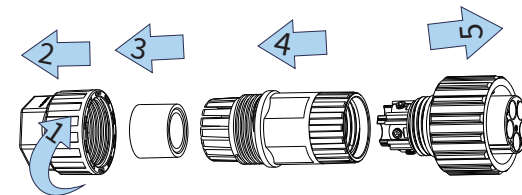

- 3 Insert the cable conductor core into the terminal and crimp. Ensure that the cable sheath is not locked into the connector.

Thread an appropriate length of AC cable through the waterproof terminal.

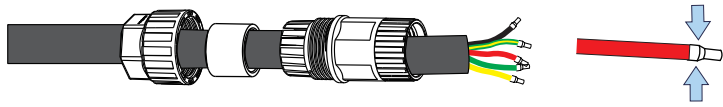

- 4 Secure all cables to the corresponding terminals with a screwdriver at a torque of 2 N·m according to the markings on the connectors.

Assemble the parts in order, making sure to tighten them.

M4  
C 1.2 N·m

Note: After tightening, it must fit tightly.

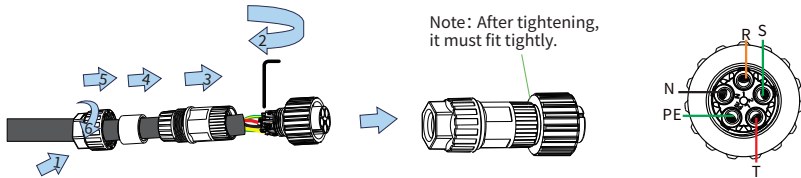

- 5 Connect the grid connector to the inverter and tighten it.



**Note:** After the AC Grid is installed, a protective cover must be added.

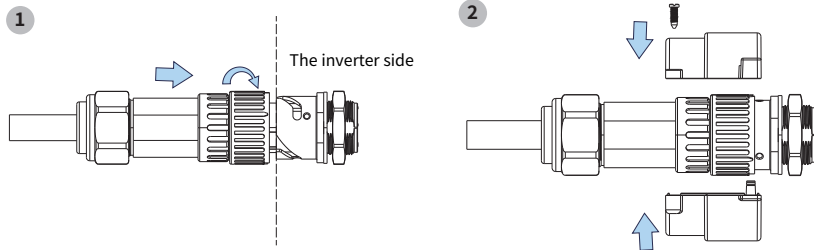

**Notice:**

- All electrical connections must be in accordance with local and national standards.
- Only with the permission of the local utility grid company, the inverter can be connected to the utility grid.

**Remove operation**

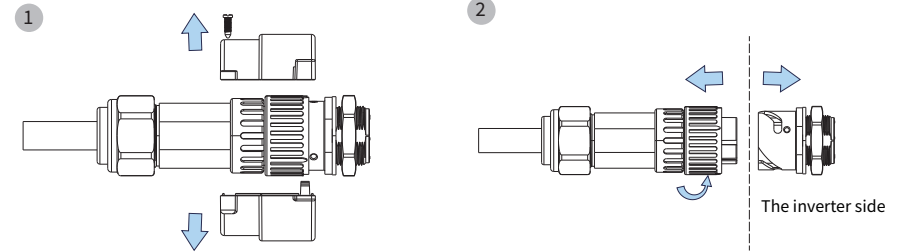

**Notice:**

If the off-grid port is not used, please install a dust plug for the AC load connector to prevent rain and dust from entering the inverter.

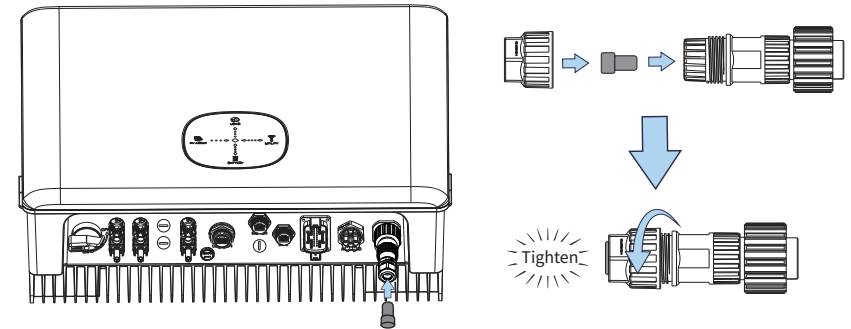

## Declarations for The Back-up Function

The back-up output of the hybrid inverters has over load ability. And the inverter has self-protection derating at high ambient temperature.

1. For the standard photovoltaic installation of the energy storage inverters, it is usually necessary to connect the inverter with photovoltaic panels and batteries. Any consequences resulting from non-compliance with this statement are excluded from the manufacturer's warranty and liability.

2. In general, the off-grid switching time is less than 20ms (considering the minimum conditions of EPS). However, some external factors may cause the system not to start off-grid mode. Therefore, we recommend users to be fully informed and follow the instructions below:

- Do not use this function if the load requires a stable power supply to ensure reliable operation.
- Do not connect loads that may exceed the maximum off-grid capacity.
- Try to avoid loads that may generate high starting current surges, such as high-power pumps, etc.
- Due to the condition of the battery itself, the battery current may be limited by some factors, including but not limited to temperature, weather, etc.

## Acceptable Loads Are as Below

The off-grid side of the 12K inverter can provide a continuous output of 12000VA for the load. The inverter also has a self-protection mechanism for derating at high ambient temperature.

- Inductive load: a single inductive load up to 4KVA.
- Capacitive load: single capacitive load up to 4KVA.

(do not accept any load with high inrush current at startup)

**Note:** To facilitate maintenance, please use an SP3T switch on the off-grid side and on-grid side. After installing the SP3T switch, you can change the load power supply mode by adjusting the circuit breaker switch, such as keeping the default state, grid power supply, and off-grid power supply.

- The off-grid load is powered by the off-grid end.
- Off-grid loads are isolated.
- The off-grid load is powered by the grid-connected end.

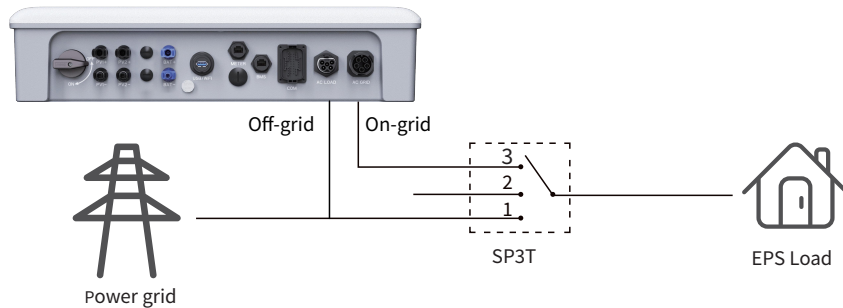

**Note:** When the output of the off-grid end is abnormal, you can manually turn the dial to gear 3 (on-grid end), so that the EPS load can work normally.

## 2.5.7 Connect smart meter



Before connecting the smart meter, make sure the AC cable is completely isolated from the AC power source.

**Note** • Please read the relevant instructions carefully when using the smart meter.  
• [Chint] DTSU666 smart meter is recommended for this product.

### Detailed PIN function of the inverter BMS port/smart meter

Item	Color	Smart meter
1	Orange and white	NC
2	Orange	NC
3	Green and white	485_B
4	Blue	485_A
5	Blue and white	NC
6	Green	NC
7	Brown and white	NC
8	Brown	NC

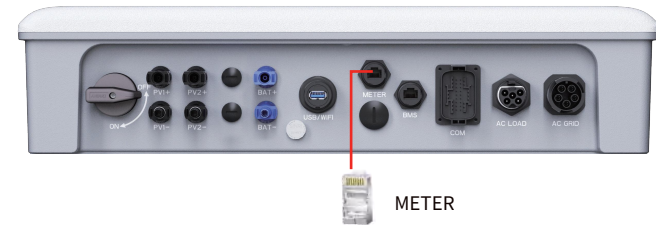

METER

## 2.5.8 Smart meter use

Item	User interface	Description	Item	User interface	Description
1		Combined active energy=10000.00kWh	11		C-phase current=5.002A
2		Forward active energy=10000.00kWh	12		Combined active power=3.291kW
3		Reverse Active Energy=2345.67kWh	13		A phase active power=1.090kW
4		The communication protocol is ModBus-RTU, n1 means no check digit and 1 stop bit; 9,600 means the baud rate is 9600bps	14		B-phase active power=1.101kW
5			15		C-phase active power=1.100kW

Item	User interface	001 means table address	Item	User interface	Description
6	UR 220.0	A phase voltage=220.0V	16	Ft 0500	combined power factor PFT=0.500
7	Ub 220.1	B phase voltage=220.1V	17	FR 1000	A phase power factor PFa=1.000
8	UC 220.2	C phase voltage=220.2V	18	Fb 0500	B phase power factor PFb=0.500
9	IR 5.000	A phase current=5.000A	19	FC -0500	C phase power factor PFC=-0.500
10	Ib 5.001	B phase current=5.001A			

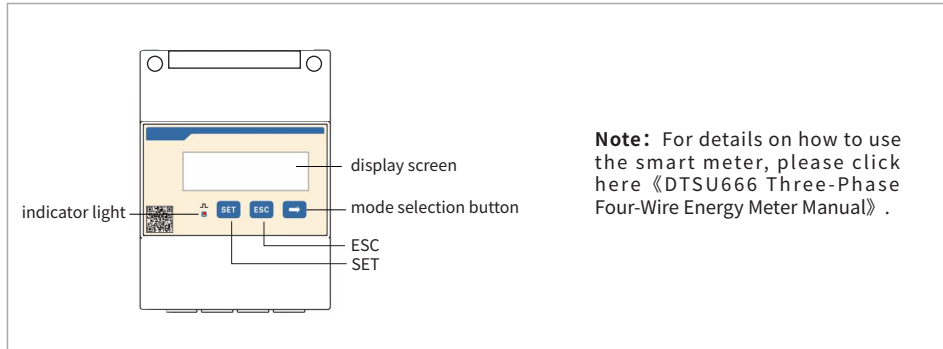

### Smart meter wiring

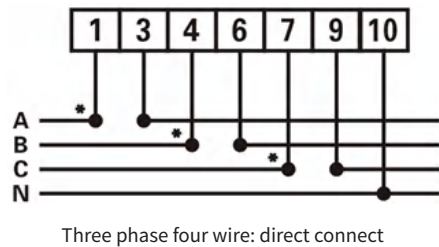

#### Voltage signal (only for meters connected via current transformer):

10-----UN(N phase voltage input terminal)

#### Current signal:

- 1-----IA\* (A phase current input terminal)
- 3-----IA (A phase current output terminal)
- 4-----IB\* (B-phase current input terminal)
- 6-----IB (B-phase current output terminal)
- 7-----IC\* (C-phase current input terminal)
- 9-----IC (C-phase current output terminal)

#### Rs485 communication line:

- 24-----A (RS485 A terminal)
- 25-----B (RS485 B terminal)

#### Auxiliary function:

- 19-----High-end output of active energy and reactive energy
- 21-----Low end of active energy and reactive energy output

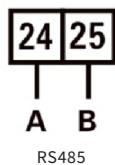

### Smart meter wiring diagram

**Note:** Please be sure to wire according to the above wiring rules, otherwise, the inverter will not operate normally.

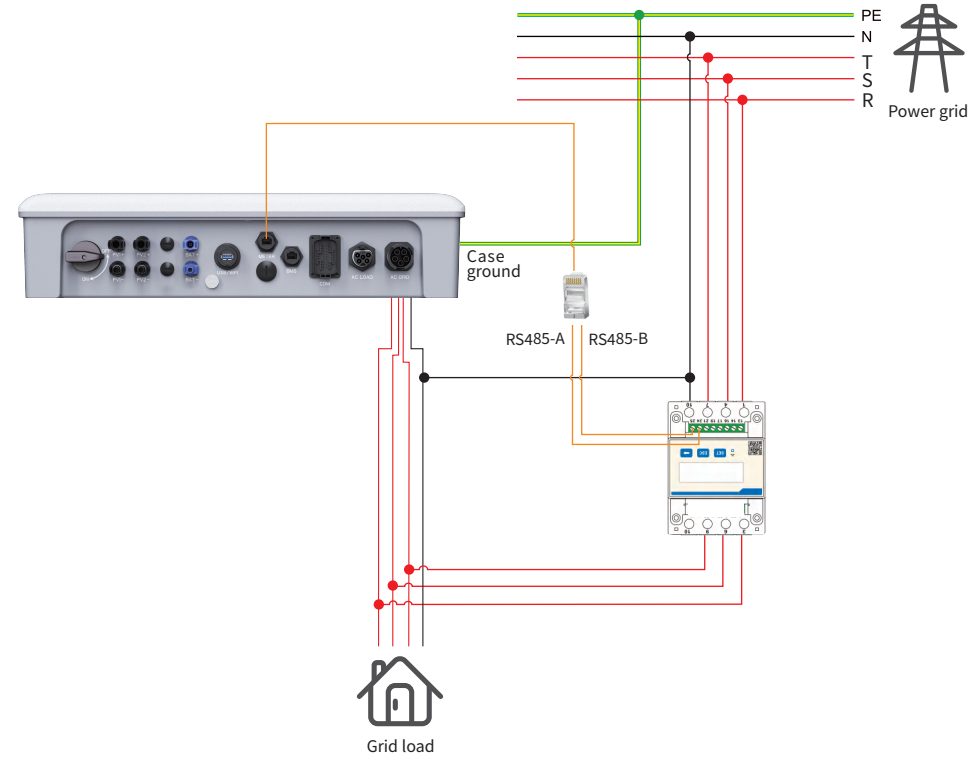

When using a smart meter, please follow the steps below to set the parameters.

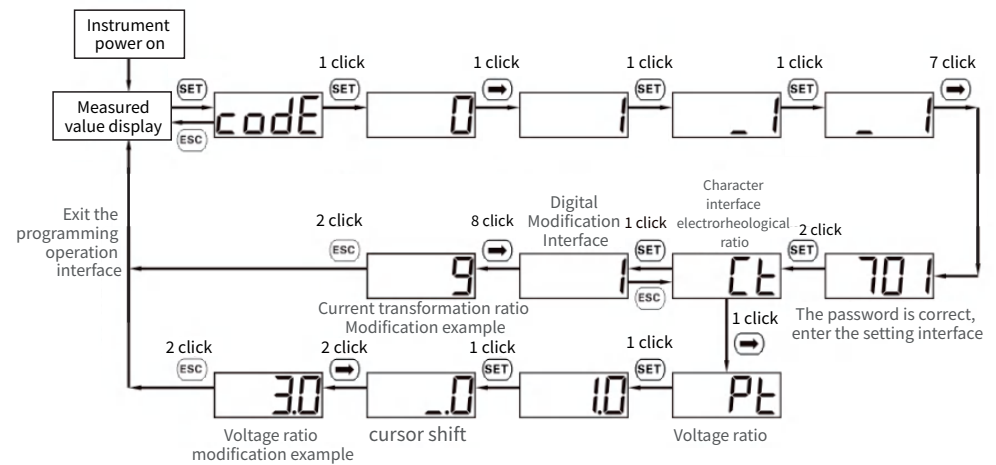

**Note:** When the smart meter is used with this product, the current ratio is set to 30, and the voltage ratio is set to 1.0.

## 2.6 Connection ground fault alarm

### 2.6.1. Inverter ground fault

The inverter complies with ICE 62109-2 13.9. In the event of an inverter ground connection fault, the inverter's fault indicator lights up. To facilitate maintenance, please install the inverter at eye level location.

### 2.6.2. External inverter ground faults

The inverter has integrated a multifunctional dry-contact (DO relay) that can be used for external alarms for earth faults. The external alarm needs to be powered from the grid. Additional equipment required is an indicator light and/or a buzzer.

If a ground fault occurs:

- The DO dry-contact will automatically switch on, signalling a ground fault alarm;
- The internal buzzer of the inverter will also sound a beep;
- The Ethernet communication port can be used to send alarms remotely.

## 2.7 Way of battery terminal wiring

### 2.7.1 Battery connection mode

1. Please refer to Section 2.5.4 for the wiring installation of the positive and negative terminals of the battery.
2. During BMS communication, one end is connected to the CAN end of the inverter, and the other end is connected to the INV\_COM of the battery. A single battery pack does not need to be connected to the Link\_Out and Link\_In terminals.
3. Communication cables are provided by the battery manufacturer.
4. Figure is an example only, please refer to the battery manual for details.

Item	Color	CAN(BMS)
1	Orange and white	WAKE_UP
2	Orange	GND
3	Green and white	NC
4	Blue	CANH
5	Blue and white	CANL
6	Green	NC
7	Brown and white	NC
8	Brown	NC

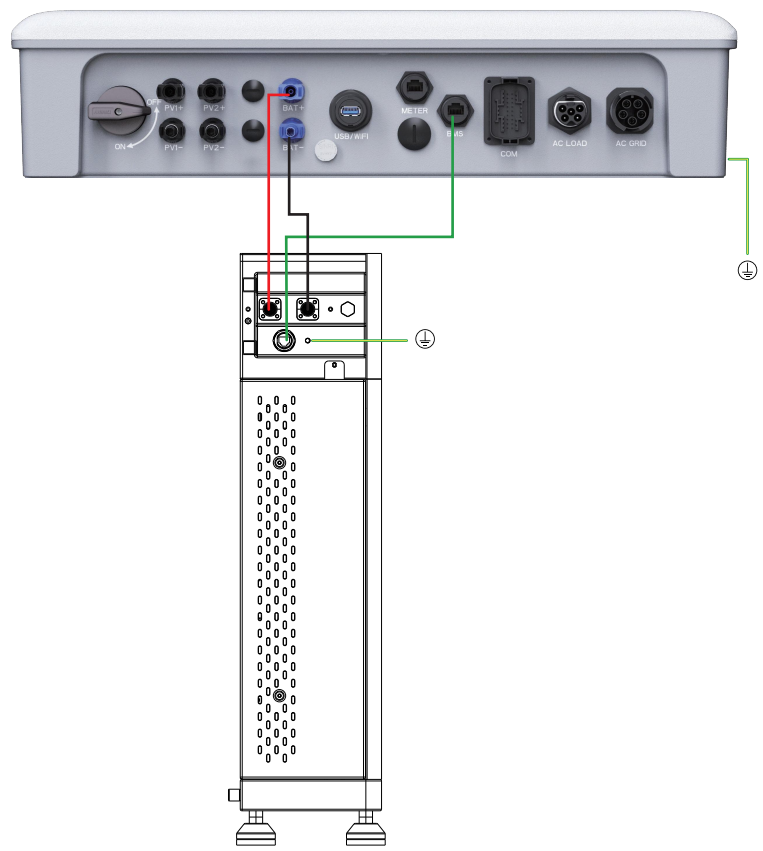

**Notice:** all non-current carrying metal parts and device enclosures in the energy storage system should be grounded.

## 2.8 Connect WIFI module

The WIFI communication function is only applicable to the WIFI module, please refer to the following figure to install the WiFi module



### 2.8.1 Stick logger installation

**Type 1** Assemble logger to the inverter communication interface as shown in the diagram.

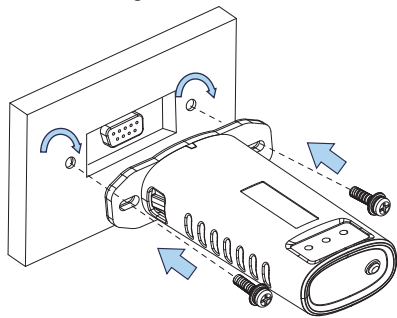

**Type 2** Assemble logger to the inverter communication interface as shown in the diagram.

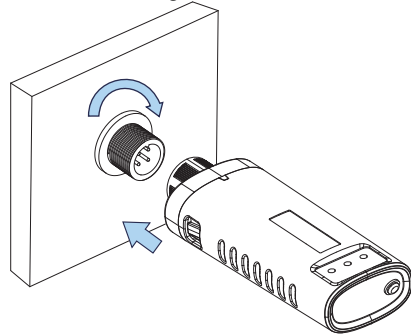

**Type 3** Assemble logger to the inverter communication interface as shown in the diagram.

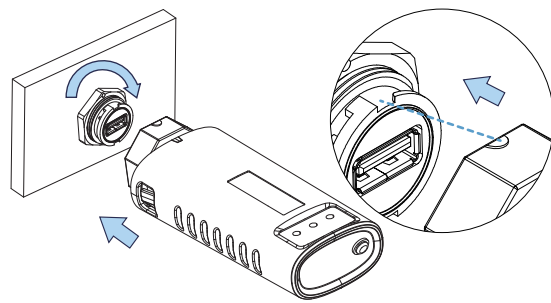

## 2.8.2 Logger status

### Check Indicator light

Lights	Implication	Status Description(All lights are single green lights.)
NET	Communication with router	1.Light off: Connection to the router failed. 2.On 1s/Off 1s(Slow flash): Connection to the router succeeded. 3.Light keeps on: Connection to the server succeeded. 4.On 100ms/Off 100ms(Fast flash): Distributing network fast.
COM	Communication with inverter	1.Light keeps on: Logger connected to the inverter. 2.Light off: Connection to the inverter failed. 3.On 1s/Off 1s(Slow flash): Communicating with inverter.
READY	Logger running status	1.Light off: Running abnormally. 2.On 1s/Off 1s (Slow flash): Running normally. 3.On 100ms/Off 100ms(Fast flash): Restore factory settings.

**The normal operation status of the stick logger, when router connected to the network normally:**

- 1.Connection to the server succeeded: NET light keeps on after the logger powered on.
- 2.Logger running normally: READY light flashes.
- 3.Connection to the inverter succeeded: COM light keeps on.

### 2.8.3 Abnormal state processing

If the data on platform is abnormal when the stick logger is running, please check the table below and according to the status of indicator lights to complete a simple troubleshooting. If it still can not be resolved or indicator lights status do not show in the table below, please contact Customer Support.

(Note: please using the following table query after power-on for 2mins at least.)

NET	COM	READY	Fault Description	Fault Cause	Solution
● NET	● COM	● READY			
Any state	OFF	Slow flash	Communicate with inverter abnormally	1.Connection between stick logger and inverter loosen. 2.Inverter does not match with stick logger's communication rate.	1.Check the connection between stick logger and inverter. Remove the stick logger and install again. 2.Check inverter's communication rate to see if it matches with stick logger's. 3.Long press Reset button for 5s, reboot stick logger.
OFF	ON	Slow flash	Connection between logger and router abnormal	1.Stick logger does not have a network. 2.Router WIFI signal strength weak.	1.Check if the wireless network configured. 2.Enhance router WIFI signal strength.
Slow flash	ON	Slow flash	Connection between logger and router normal, connection between logger and remote server abnormal.	1.Router networking abnormal. 2.The server point of logger is modified. 3.Network limitation, server cannot be connected.	1.Check if the router has access to the network. 2.Check the router's setting, if the connection is limited. 3.Contact our customer service.
OFF	OFF	OFF	Power supply abnormal	1.Connection between stick logger and inverter loosen or abnormal. 2.Inverter power insufficient. 3.Stick Logger abnormal.	1.Check the connection, remove the stick logger and install again. 2.Check inverter output power. 3.Contact our customer service.
Fast flash	Any state	Any state	Networking status	Normal	1.Exit automatically after 2mins. 2.Long press Reset button for 5s, reboot stick logger. 3.Long press Reset button for 10s, restore factory settings.
Any state	Any state	Fast flash	Restore factory settings	Normal	1.Exit automatically after 1mins. 2.Long press Reset button for 5s, reboot stick logger. 3.Long press Reset button for 10s, restore factory settings.

**Warning:** Please do not hold the logger body to rotate while install or remove the logger.

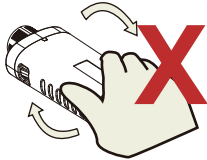

**Notice:** Do not remove waterproof plug.



### 2.9 The connection mode of COM

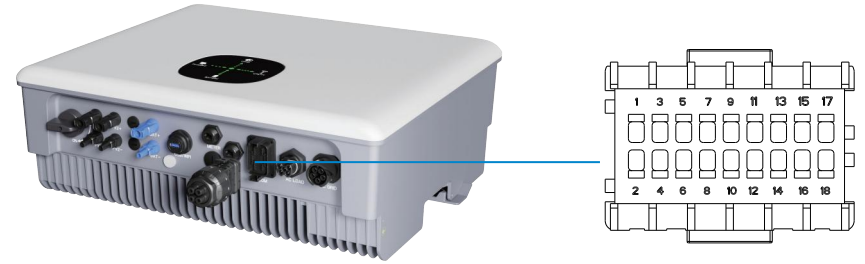

- |                  |              |              |              |
|------------------|--------------|--------------|--------------|
| 1. DRM 1/5       | 2. 485_A     | 3. DRM 2/6   | 4. 485_B     |
| 5. DRM 3/7       | 6. COM/DRM 0 | 7. DRM 4/8   | 8. REF       |
| 9.10. GND_S/NTC- | 11. WET_RLY  | 12. BAT-NTC+ | 13.14. +12VS |
| 15.16. DO-       | 17.18. DO+   |              |              |

1 Disassemble the COM terminal first.

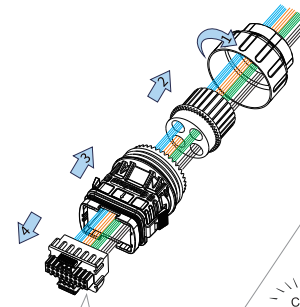

Press and hold the buckles on both ends at the same time.

2 Install the wires as shown below.

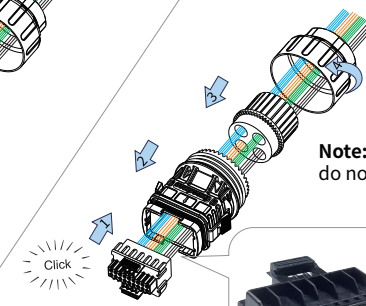

**Note:** Wire colors in this illustration do not represent actual colors.

1. Press and hold the yellow button.
2. Insert the stripped end of the wire into the hole.
3. Release the yellow button.

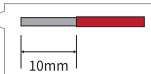

3 Connect the COM to the inverter plug until both are tightly locked on the inverter.

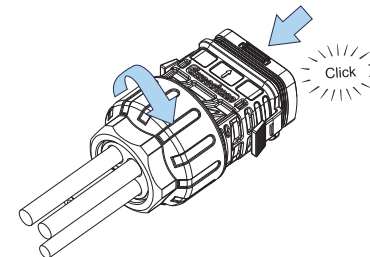

## DRM ("AU"/"NZ")

- When the inverter is applied in Australia, the DRMS terminal needs to be connected.

The following table lists the DRMs supported by the inverter.

Mode	Requirement
DRM0	Operate the disconnection device.
DRM1	Do not consume power.
DRM2	Do not consume at more than 50% of rate power.
DRM3	Do not consume at more than 75% of rate power AND Source reactive power if capable.
DRM4	Increase power consumption (subject to constraints from other active DRMs).
DRM5	Do not generate power.
DRM6	Do not generate at more than 50% of rate power.
DRM7	Do not generate at more than 75% of rate power AND Sink reactive power if capable.
DRM8	Increase power generation (subject to constraints from other active DRMs).

\*The DRM is only for regions with AS/NZW 4777.2 safety regulations.

## 3. Commissioning

### 3.1 Inspection before commissioning

#### 3.1.1 Connection check

##### PV Side

1. Before checking, make sure that the DC switch and the breaker of the combiner box on the AC side are disconnected. Prevent electric shock.
2. The DC cables need to be crimped into MC4 terminals in order to connect with the PV+/PV- terminals of the inverter. The connection should be tightened tightly to ensure good contact of the terminals and prevent water from entering.
3. When wiring the DC side, pay attention to the positive and negative polarity of the cables and the connection sequence of the components, which correspond to the numbers of the branch terminals at the lower end of the inverter. Avoid cross wiring or reverse polarity.

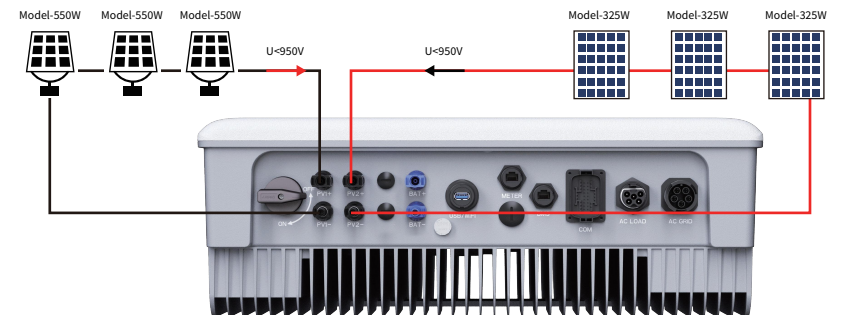
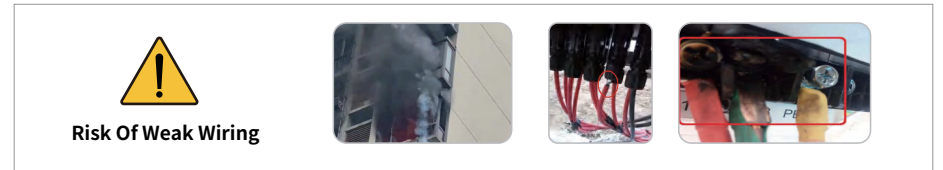
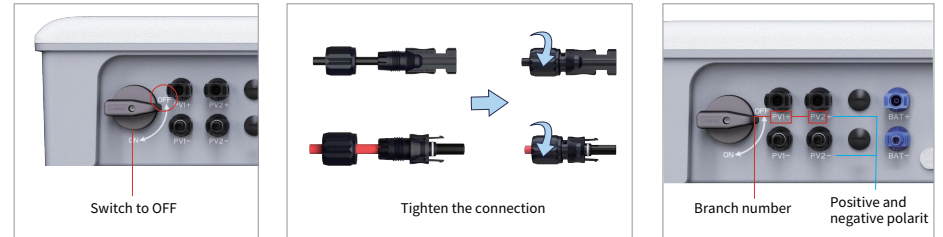



## Photovoltaic Module Access Requirements

1. Under the same MPPT, modules with consistent photovoltaic characteristics should be used for connection.
2. Under the same MPPT, ensure that the number of photovoltaic modules connected is consistent; the number of photovoltaic modules connected to different MPPTs cannot exceed one.
3. The maximum open circuit voltage of each branch cannot be greater than 950VDC under any circumstances.

## AC Side

1. The definition marks of each terminal can be observed on the AC connection terminal. When connecting, pay special attention to the position of the R, S, T, N and PE cables to ensure that the cables are connected correctly without wrong connection or missing connection. The screws on the terminals are tight and there is no looseness.
2. When the AC plug is inserted into the inverter, make sure that the latch is locked firmly.

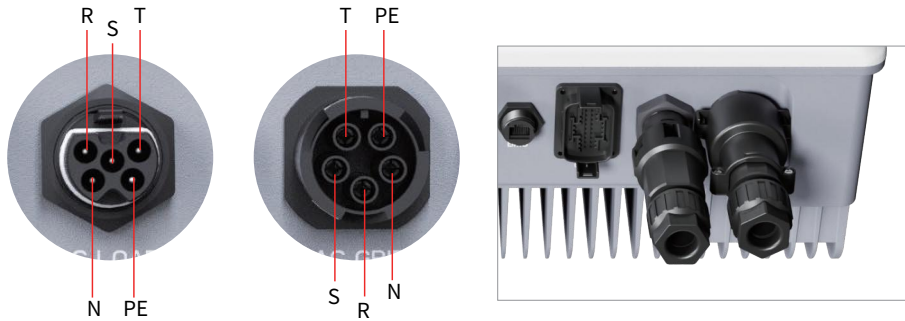

## Battery Side

1. The battery cable must distinguish the positive and negative poles and connect them accordingly.
2. The blue BAT plugs are similar to the black PV plugs. Make sure the connectors are correct before use.

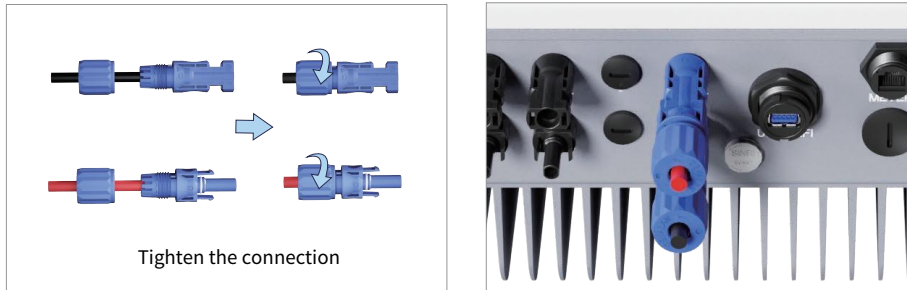

## 3.1.2 Electrical inspection

Observe the table of the three-phase inverter. When wiring, electrical inspection should be carried out to ensure that the AC and DC parameters are within the range of the label to avoid damage to the inverter due to external wiring problems.

\* The pictures shown here are for reference only. The actual products and labels are subject to delivery.

hinen Hybrid Inverter	
Model name	H12000H-EU
PV input data	
Max.PV voltage	1000V <sub>dc</sub>
PV voltage range	160-1000V <sub>dc</sub>
Max.input current	16Ad <sub>c</sub> ±2
PV short current	22Ad <sub>c</sub> ±2
Max.PV input power	18000W
AC input/output data (50/60Hz)	
Max. output power	12000W
Rated output apparent power	12000VA
Minimum voltage	9600W±0.0020W±0.3NPN
Max.input/output current	26.37A <sub>dc</sub>
Nominal frequency	50/60 Hz
Power factor range	±10.0Leading - 0.8Lagging
AC output data(50/60Hz)	
Max. output current	18.2A <sub>dc</sub>
Max AC output apparent power	12000VA
Rated AC output power	12000W
Nominal AC output voltage	9600W±0.0020W±0.3NPN
Nominal AC output frequency	50/60 Hz
Battery data	
Battery voltage range	100-400V <sub>dc</sub>
Max charging and discharging current	45Ad <sub>c</sub>
Type of battery	Lithium ion battery
Others	
Weight	18.5kg
Dimensions(W*H*D)	532*425*193MM
Inverter topology	PV non-isolated, battery non-isolated
Ingress protection	IP65
Protective Class	Class I
Operation ambient temperature	-25℃~+45℃
Copyright Hinen New Energy Technology Co., Ltd	
S/N:H12000HEU012403C00001	

Nameplate

## PV Side

### Open circuit voltage and polarity

• Turn the multimeter to the DC position, connect the red test lead (positive pole) to the positive pole of the string, and connect the black test lead (negative pole) to the negative pole of the string, and the displayed voltage is the current open circuit voltage.

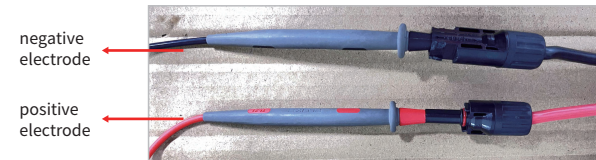

• In the following figure, the multimeter displays the current open circuit voltage of 600V, the red test lead is connected to the positive pole, the black test lead is connected to the negative pole, and the positive and negative polarities are correct; if the positive and negative poles are reversed, the multimeter will display -600V. It is forbidden to turn on the inverter at this time, and you need to contact the construction unit to rectify the cables.

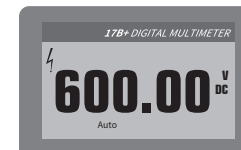

normal circumstances.

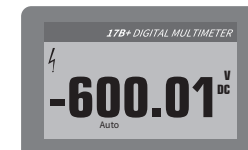

Positive and negative reverse connection

## Checking Method for String Grounding

- Turn the multimeter to the DC voltage position, put the red test lead on the measured cable, and the black test lead on the ground terminal. Under normal circumstances, the voltage to ground is half of the open circuit voltage, and the voltage gradually decreases during measurement.
- If it is found that the voltage to the ground is equal to zero or the open circuit voltage, then the branch cable is grounded, and the construction team must be ordered to make rectification.
- Grid connection is allowed after the rectification is completed and no grounding condition is checked. It is strictly forbidden to connect to the grid before the grounding condition is not resolved.

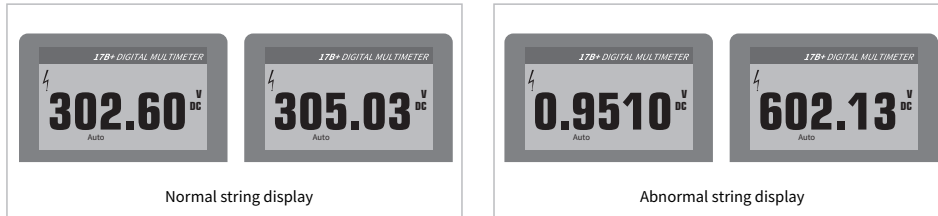

## The multimeter is dialled to the AC voltage level

- Detect the line voltage between the L1/L2/L3 three-phase in turn. Under normal circumstances, the voltage between the L1/L2/L3 three-phase should be roughly equal, about 400V.



Detecting the voltage between three phases

- Detect the voltage between between the L1/L2/L3 three-phase and the N-wire in turn. Under normal circumstances, the voltage between etween the L1/L2/L3 three-phase and the N-wire is roughly equal, about 230V.



Detecting voltage between L1/L2/L3 and N-wire

**Warning:** If the neutral line and live wire are reversed, the measured value is very different from the normal situation, and the machine will report an alarm of abnormal grid voltage and shut down. Please contact the construction party to rectify the AC cable.

## Battery Side

### Open circuit voltage and polarity

- Turn the multimeter to the DC position, connect the red test lead (positive pole) to the red terminal of the battery, and connect the black test lead (negative pole) to the black terminal of the battery, and the displayed voltage is the battery voltage.

- In the picture on the right, the multimeter shows that the current battery voltage is 500V, the red test lead is connected to the positive pole, the black test lead is connected to the negative pole, and the positive and negative polarities are correct; if the positive and negative poles are reversed, the multimeter will display -500V, It is forbidden to connect the battery at this time, and you need to contact the construction unit to rectify the cable.

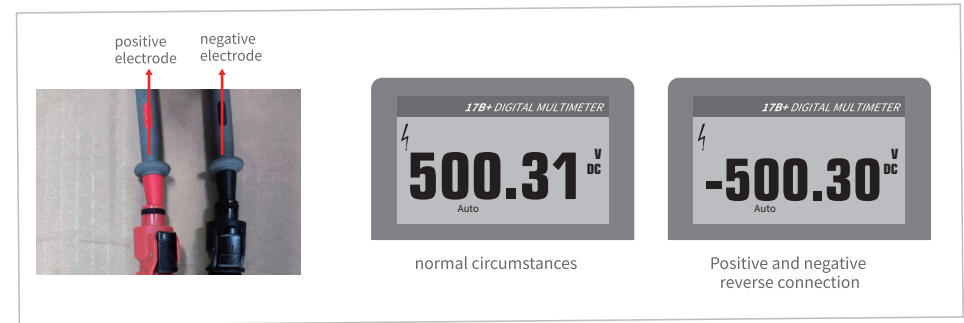

## 3.2 Powering on the system

### 3.2.1 Boot steps

- After ensuring that the electrical connection is completed normally, perform the power-on operation to turn on the inverter.

1. Set the "PV SWITCH" of the inverter to "ON".
2. Turn on the external AC circuit breaker, and the inverter lamp board will self-check.
3. After the self-Inspection is completed, the PV and GRID flowing led light are always on, and the intermediate status lights are always on and wait for grid connection.
4. When the battery is turned on, the BAT flowing led light is always on and still.
5. The APP sends a power-on command. (The first installation will start by default)
6. After passing the 2-3min self-inspection, it will be connected to the grid, the LOAD flow lights will tight up, and all the flow lights will low according to the actual power.

- Execute the above steps, if there is no fault in the system, the inverter starts up successfully.

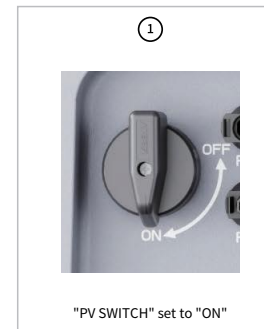

"PV SWITCH" set to "ON"

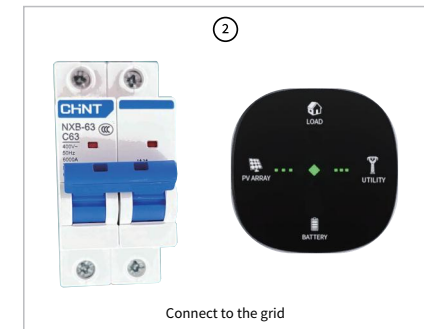

Connect to the grid

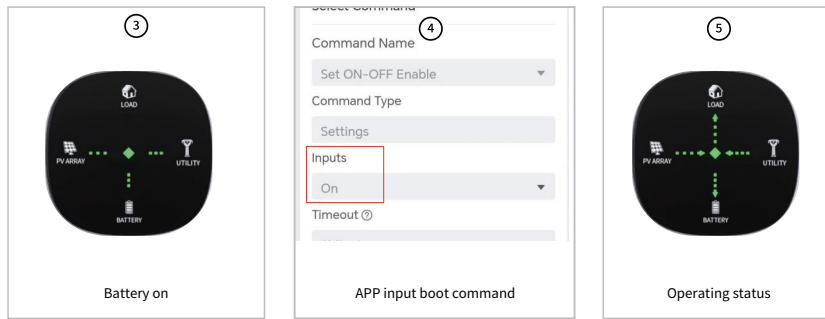

### 3.3 Shutting down the system

#### Shutdown steps

- If maintenance or inspection is required, please follow the steps below to shut down the machine.
1. Send a shutdown command through the data collector or near-end APP software to shut down the inverter.
  2. Disconnect the PV circuit breaker and put the "PV SWITCH" in the "OFF" state.
  3. Turn off the circuit breaker between the inverter and the grid.
  4. Press and hold the battery POWER BUTTON connected to the inverter for 3 seconds to turn off the battery.
  5. Switch off the battery circuit breaker.

#### Precautions

- When powering off the system, be sure to follow the operating instructions and safety regulations.
- After the inverter is shut down, there will be residual power and residual heat in the chassis, which may cause electric shock or burns. Please make sure the inverter is fully discharged, or operate the inverter after 5 minutes.



## 4. APP

### 4.1 Internet connection

With the WIFI module installed, view corresponding information through SOLARMAN APP or SOLARMAN WEB.

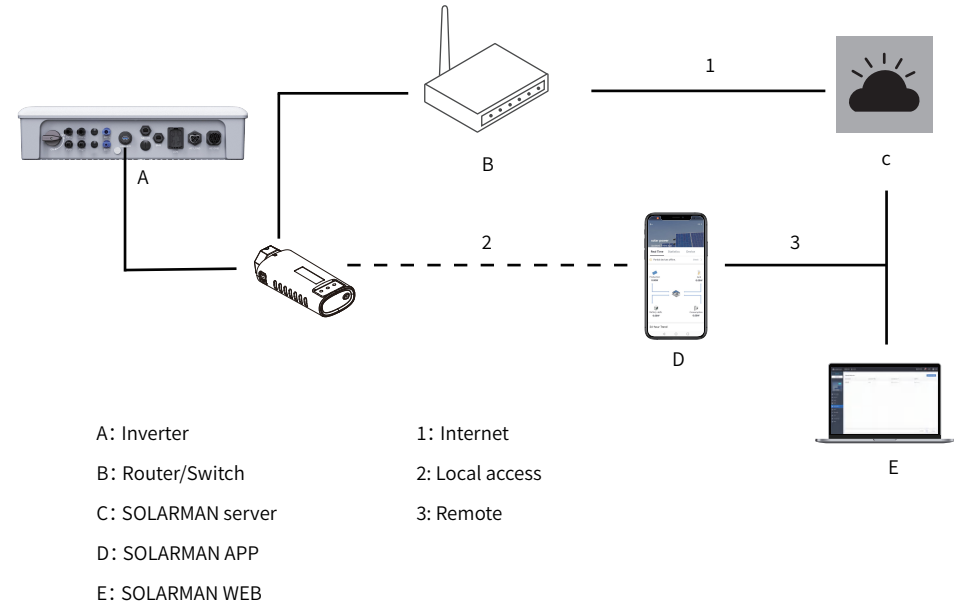

### 4.2 APP preparation

#### 4.2.1 Download & use the APP

##### Method 1

Download and install the App through the following application stores:

- MyApp (Android, mainland China users).
- Google Play (Android, users other than mainland China ones)
- App Store (iOS)

## Method 2

Scan the following QR code to download and install the App according to the prompt information.



- The App icon appears on the home screen after installation.

**Notice:** Screenshots in this manual are based on the V1.7.12 App for Android system, and the actual interfaces may differ.

### 4.2.2 User registration

There are two ways to register: email registration and mobile phone number registration. Enter your mobile phone number or email account number, get the corresponding SMS verification code, set a password yourself, and click "I have read and agreed to accept T&Cs and Privacy Policy" and "Done" to complete the registration.

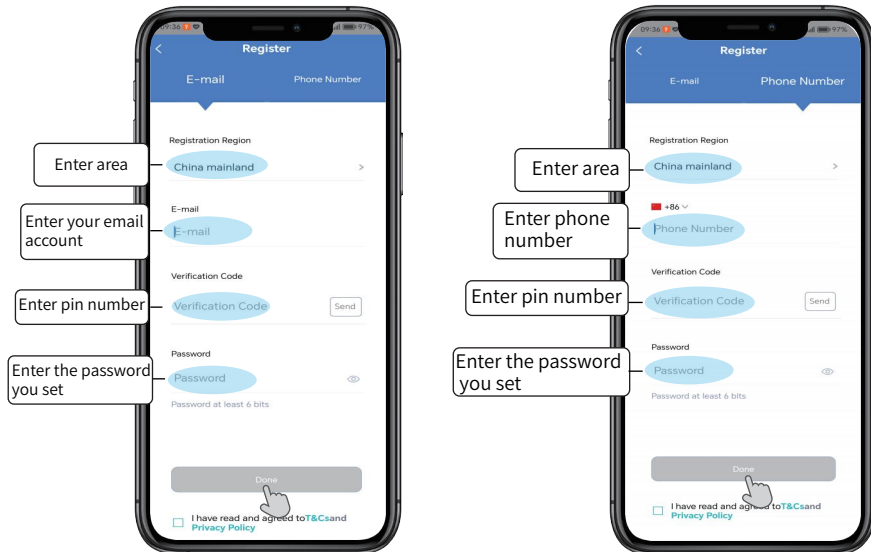

### 4.3 Plant creation

After successful login, enter the main interface, please click the "Add Now" button to enter the add power plant interface. Please choose whether the installer is responsible for the post operation and maintenance of the power plant according to the actual situation.

1

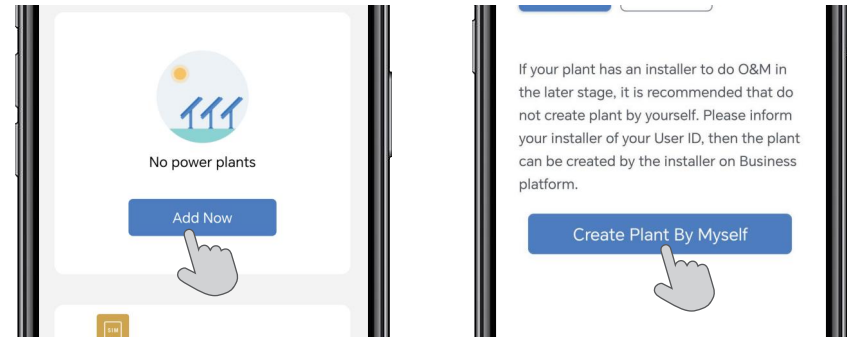

2

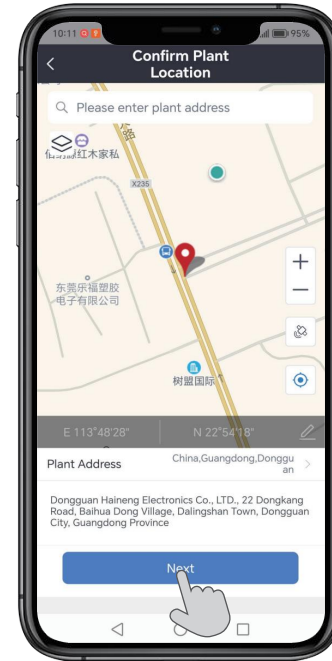

The system will automatically start positioning to confirm the location of the power plant. If the address positioning is not accurate, you can choose to select manual positioning.

**3**

After determining the location of the power plant, enter the power plant information. Please fill in according to your equipment information, and consult the installer if you have any questions.

Take the 12KW Three-Phase Hybrid Solar Inverter as an example. First, give the power plant a name, and then select "Storage System" as the grid-connected type, fill in "12" for the installed capacity according to the model. Fill in the income information according to the local electricity fee, and click "Done" to create the information.

**2**

As shown in the figure, you can enter the serial number of your logger in the serial number input box, or click on the scan code on the right side of the input box to add your logger by scanning the code. The serial number and QR code of your logger are printed on the front of your logger device.

#### 4.4 Add a logger

**1**

After completing the creation, a successful creation interface will appear, we can click "Go to Add" to add a logger.

**3**

Click the Add button when you have finished entering the scan code or serial number to enter the page of selecting related equipment. Please choose to automatically associate devices, and click "Done".

## 4.5 Device networking

1

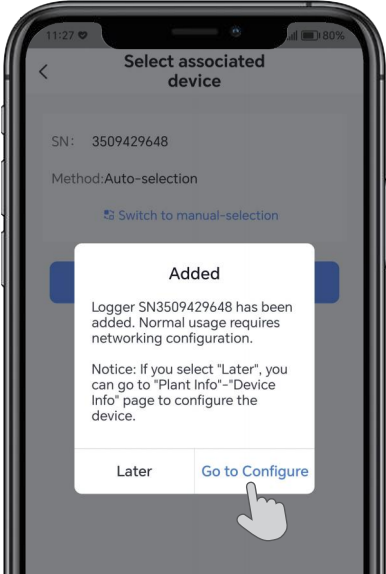

After adding the logger successfully, the prompt box of adding the logger successfully will pop up, where you can choose "Go to Configure" to configure the network for the logger.

2



Before networking configuration, you need to connect WiFi and turn on the Bluetooth function according to the prompts. If there is no shared WiFi in your area, you can also use your mobile phone to turn on the hotspot to connect the logger to WiFi.

After Bluetooth is turned on and WiFi connection is successful, we will enter the following interface and enter the password to confirm that there are no errors in succession. Click "Start to configure" to enter the interface of configuring equipment detection. Please wait patiently.

3

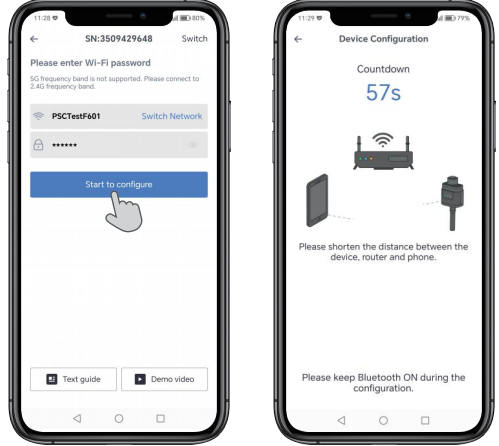

3

4

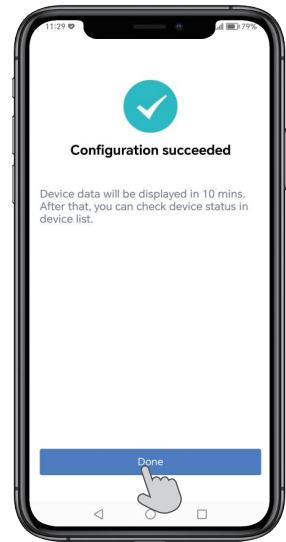

Configuration succeeded.

Click "Done" and we will go to the home page.

## 4.6 Observe the running status of the device

After the power plant is built and the logger is successfully added, we can see the working status of the entire energy storage system in real time. In "Real Time", we can see the working situation of the energy storage system, the situation of 24 hours of generation power and discharge power, and the statistics of how much discharge and power generation today.

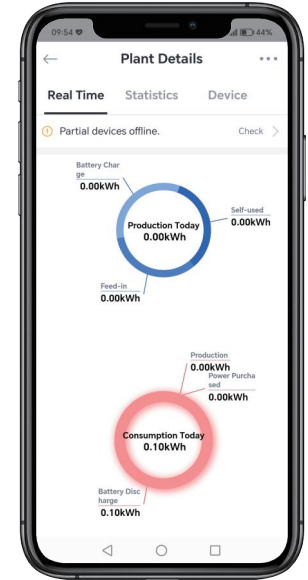
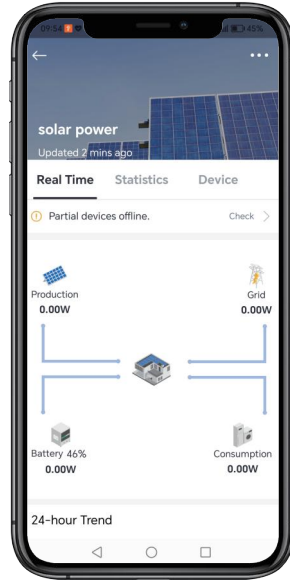

In the "Statistics" interface, we can also see the data information of system operation.

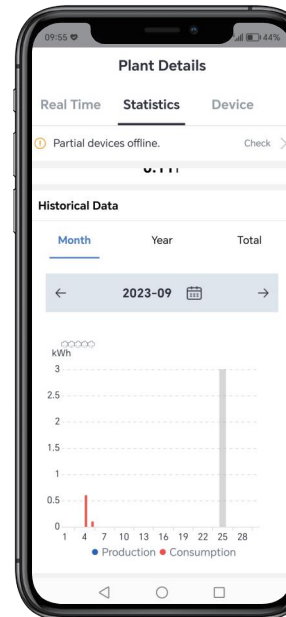
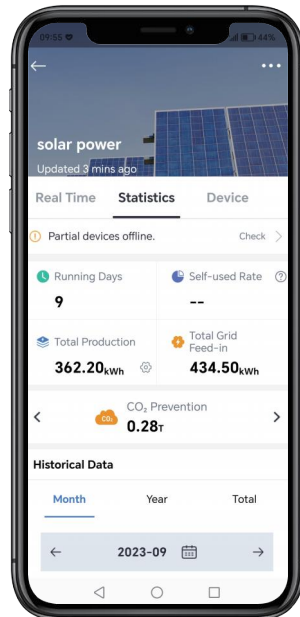

## 4.7 View the system information and parameters

### Enter to view the system information and parameters

- 1 Click anywhere on this page to enter the power station.

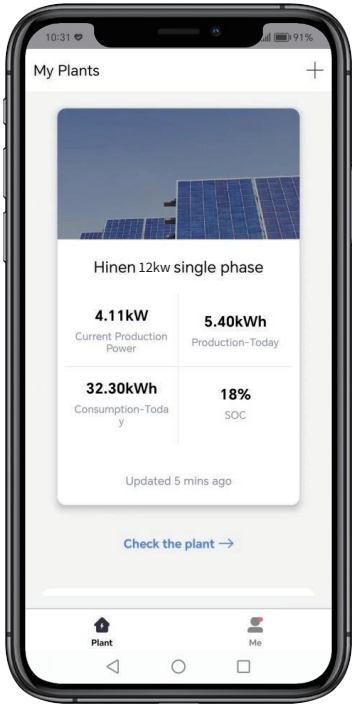

- 2 Click on "Devices".

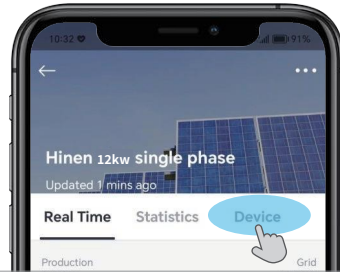

- 3 Click "Inverter" and "Inverter name/SN number".



- 4 Enter the following interface, the first one is "Device Parameters".

Click on "System Parameters".

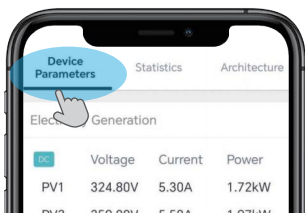

### System information and parameter introduction

No	Name	Description
1	Electricity Generation	Shows the information on DC power generation, AC power generation, total power generation, etc.
2	Basic information	Shows the main inverter model, rated power, system type, operating mode and other basic information.
3	Version Information	Shows the software version of the inverter, the software version of the matched battery and the hardware version of the battery.
4	Power Grid	Shows the total power of the grid, the cumulative amount of grid connection, the cumulative amount of purchased power, etc.
5	Electricity Consumption	Shows the power consumption, total power consumption, cumulative power consumption, today's power consumption, etc.
6	Battery	Shows the status of the battery, battery type, battery voltage, battery power, etc.
7	BMS	Indicates the basic information of the battery management system BMS: including the maximum discharge current of the BMS, the battery CV voltage, the number of parallel batteries and other basic information.
8	Temperature	Shows the main system operating ambient temperature, inverter radiator temperature, radiator temperature information.
9	State	Shows the current working state of the inverter: there are several states such as on-grid state, off-grid state, fault state and so on.
10	Alert	Shows mainly the alarm information of the system, when the system malfunctions, the corresponding fault code will be displayed, which mainly includes the fault code of the inverter and the fault code of the BMS battery.
11	Control	Indicates the current priority of the system: generally there are three priority modes: load priority, battery priority, and grid priority.
12	Off-grid	The main information here is the frequency, voltage and current of the off-grid side.



Electricity Generation			
<b>DC</b>	Voltage	Current	Power
PV1	327.80V	3.50A	1.16kW
PV2	354.00V	3.60A	1.30kW
<b>AC</b>	Voltage	Current	Frequency
R	233.50V	12.60A	49.96Hz
S	0.00V	0.00A	--
T	0.00V	0.00A	--
PV Total Power: 2.46kW		Total Power Generation: 49.70W	
Local load power: 3.02kW		Total AC Output Power (Active): 2.46kW	
Total Active Power: 3.17kW		inspecting power: 3.17kVA	
Reactive Power: 0.00kvar		Reactive Power-R phase: 0.00Var	
Reactive Power-S phase: 0.00Var		Reactive Power-T phase: 0.00Var	
Apparent Power-R phase: 3174.10VA		Apparent Power-S phase: 0.00VA	
Apparent Power-T phase: 0.00VA		Power factor: 1.0	
Cumulative Production (Active): 45.30kWh		Daily Production (Active): 5.70kWh	

## Electricity Generation

The main information here is the generation information of the system, including DC generation, AC generation, total PV power, total generation power, local load power, total AC output power (active), and total active power. Here there are mainly three phases R\S\T and the corresponding active power, reactive power and apparent power. As well as the power factor, the cumulative power generation (active) at the last time, and the power generation (active) of the day.

Basic Information	
SN: SH6KL-01-2241-C-000 07	Rated Power: 6.00kW
Device Type: Single-phase energy storage converter	Working Mode: S0EU01T00E0FP0600B0 600
System Time: 2023-12-02 10:35:48	

## Basic information

Here is the basic information of the system, including the SN number of the inverter, power rating, device type, system operating mode, and current time of the system.

Version Information	
Monitoring Software Version: MAHN3	Software Version Identifier: ALHN030303
Production Compliance Version: AL1.0	Battery software version: 742
Battery Hardware Version: 2307	

## Version Information

Here is the system version information, including the system's software version, battery software version, and battery hardware version. The system software version includes the monitoring software version, the software version identification and the safety regulation version.

Power Grid	
Total Grid Power: 33.00W	Cumulative Grid Feed-in: 1.50kWh
Cumulative Energy Purchased: 102.20kWh	Daily Grid Feed-in: 0.00kWh
Daily Energy Purchased: S Phase Grid Active Power: 27.30kWh 0.00W	
T Phase Grid Active Power: 0.00W	R-phase Grid Active Power: 3.16kW
R-phase Power Extraction: 0.00W	S Phase Power Extraction: 0.00W
T-phase Power Extraction: 0.00W	R-phase Power Generation: 33.00W
S-phase Power Generation: 0.00W	T-phase Power Generation: 0.00W
Grid Charging Power: 0.00W	

## Power Grid

The main information here is about the grid, including the total power of the grid, the cumulative amount of grid connection, the cumulative amount of power purchased, the amount of grid connection on the day, and the amount of power purchased on the day. There are a total of three phases of the grid, R/S/T, including active power, withdrawal power, generation power, and grid charging power for each phase.

Electricity Consumption	
Electric Power: 3.27kW	Total Consumption Power: 3.12kW
Output Power (%): 0%	Cumulative Consumption: 151.50kWh
Daily Consumption: 32.90kWh	

## Electricity Consumption

This refers to the system's power consumption, total power consumption, percentage of power output, cumulative power consumption and power consumption for the day.

Battery	
Battery Status: Discharging	Battery Charging Type: Lithium Battery
Battery Voltage: 51.90V	Battery Voltage1: 52.20V
Battery Power: 690.00W	Battery Discharging Power: 690.00W
Battery Charging Power: 0.00W	SoC: 18%
SoH: 97%	Total Charging Energy: 10.10kWh
Total Discharging Energy: 15.40kWh	Daily Charging Energy: 1.80kWh
Daily Discharging Energy: 1.50kWh	Highest Individual Voltage No.: 0
Lowest Individual Voltage Number: 0	Highest Temperature Number: 0
Lowest Temperature Number: 0	Battery Factory: 3
Cycle Count: 0	Pack Fault ID: 0
Battery Maximum Soc: 0	Minimum Battery Soc: 0
BDU_Battery_Number: 0	

## Battery

Here is the information about the batteries assigned to the system: current battery status, battery type, battery host voltage, battery slave voltage, battery power, battery charging power, battery discharging power, remaining battery capacity (SOC), battery health index (SOH), cumulative battery charging, cumulative battery discharging, battery charging on the day, battery discharging on the day, and so on.

Temperature	
Environment Temperature: 48.20°C	Inverter radiator temperature: 46.40°C
Radiator Temperature: 36.30°C	

## Temperature

The main information here is the ambient temperature at which the system operates, the temperature of the inverter's heat sink, the temperature of the heat sink.

State	
Inverter status: Grid-connected State	Debug Information 1: 0
Debug Information 2: 12	Debug Information 3: 0
debug info 4: 4	debug info 5: 5
debug info 6: 6	debug info 7: 7
debug info 8: 0	debug info 9: 0
debug info 10: 2	debug info 11: 3994
debug info 12: 4734	debug info 13: 5
debug info 14: 6	debug info 15: 7
debug info 16: 0	BMS state: 0
Busbar Voltage 1: 395.40V	Busbar Voltage 2: 395.70V

## State

Here is the working status of the inverter, which mainly includes grid-connected status, off-grid status, fault status, etc., system debugging information, BMS status, system bus voltage 1, system bus voltage 2, etc.

Control
Charging Source Priority Selection: Load Priority

## Control

Here is the main system priority information, the system mainly has load priority, battery priority, grid priority these three priority. Load priority that is not set to charge the battery fast charging and discharging, the default is load priority, priority power supply to the load to use; battery charging that is set to charge the battery, it is the battery priority; set the battery to the grid when the battery is discharged, that is, the grid priority. But no matter which kind of priority, it is the priority to supply power to the load, and more power then to the battery or the grid.

Alert	
Fault Code1: 0	Fault Code2: 0
Fault Code3: 0	Fault Code4: 0
Fault Code5: 0	Fault Code6: 0
Fault Code7: 0	Fault Code8: 0
BMS Failure: 0	

## Alert

Here is mainly the system's alarm information, when the information is faulty, the alarm code will be displayed, generally fault code 1 is the main fault code, fault code 2-8 is the sub-fault code as well as the BMS battery failure information.

If you want to know more detailed information, please refer to the user manual on the APP, as shown below:

BMS	
BMS Voltage: 51.80V	BMS Current: -10.00A
BMS Temperature: 19.50°C	BMS Max Charge Current: 71.40A
BMS Max Discharge Current: 89.60A	BMS_SOC: 18%
battery cell maximum temperature: 0.00°C	Minimum temperature of battery cell: 0.00°C
Maximum Pressure Difference Of Single Cell: 0	Battery CV Voltage: 57.60V
Highest Monomer Voltage: 0.00V	Lowest Monomer Voltage: 0.00V
Number Of Batteries In Parallel: 1	Gauge RM: 0
Gauge FCC: 0	

**BMS**

Here is the main battery management system BMS related information, including BMS battery voltage, BMS battery current, BMS temperature, BMS maximum charging current, BMS maximum discharging current, BMS SOC and so on.

Off-grid	
Off-Grid Frequency: 0.00Hz	R-Phase Off-Grid Voltage: 234.70V
R-Phase Off-Grid Current: 0.20A	R-Phase Off-Grid Apparent Power: 60.00VA
R-Phase Off-Grid Active Power: 0.00W	S-Phase Off-Grid Voltage: 0.00V
S-Phase Off-Grid Current: 0.00A	S-Phase Off-Grid Apparent Power: 0.00VA
S-Phase Off-Grid Active Power: 0.00W	T-Phase Off-Grid Voltage: 0.00V
T-Phase Off-Grid Current: 0.00A	T-Phase Off-Grid Apparent Power: 0.00VA
T-Phase Off-Grid Active Power: 0.00W	Off-Grid Output Load Factor: 0%

**Off-Grid**

The main information here is the off-grid information of the system, which mainly includes off-grid frequency, R/S/T phase off-grid voltage, off-grid current, off-grid apparent power, off-grid active power, and off-grid output load factor.

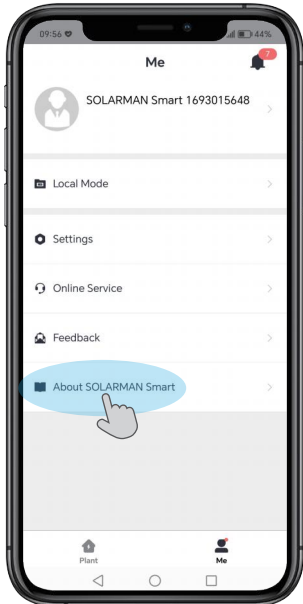
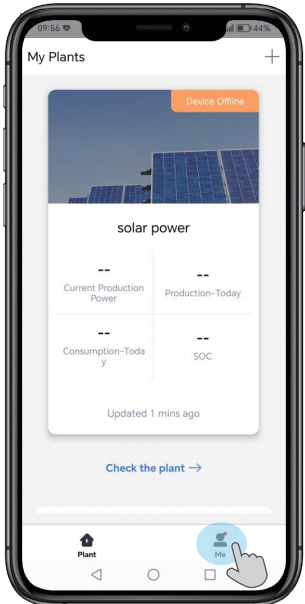

- 1
- 2
- 3
- 4

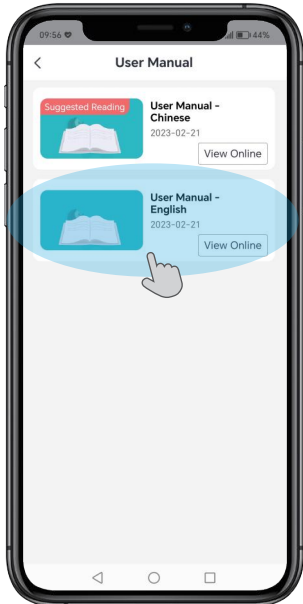
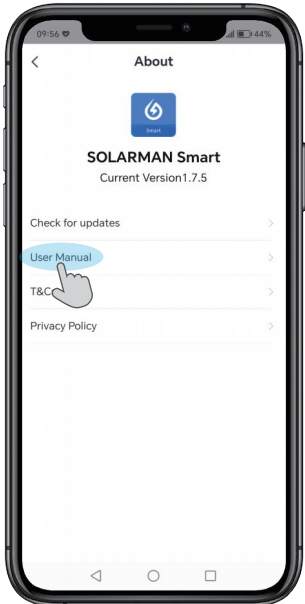

## 4.8 Settings

The following settings with "⚠️" can only be viewed but not changed. If you need to change them, please contact your installer or HINEN.

\* The following is an example of a user version that can only read view fields/commands. The user will not be able to click on any of the locked fields / commands after the system has been commissioned.

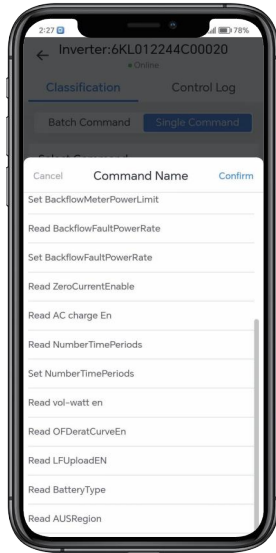

### 4.8.1 Common settings

Click "Device" to enter the following interface, click "Remote Control".

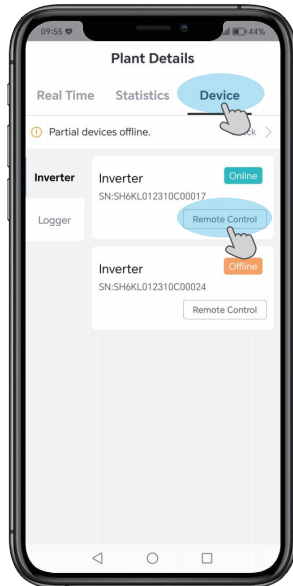

## Remote Power Control

You can find the "Remote Power Control" function in the "Batch Commands", which is a setting to control fast charging and discharging.

• **Setting fast charging and discharging enable:** Enable/Disable for Enable Setting, Disable Setting.

• **Setting fast charging and discharging time:** from "0:00" to "23:00", which means that it can only be charged and discharged in the set time.

**Note:** under normal circumstances, the battery stops charging when it is charged to 100%, and stops discharging when it is discharged to 10%. The start and stop SOC of the battery when it is charging or discharging can be set using "Load First Settings".

• **Setting fast charging and discharging power:** the range is from "-100 to 100" %, from "-100 to 0" % for discharge power, from "0 to 100" % for charging power.

• **In the charge and discharge setting,** if the set time is "0:00", that is, charge and discharge all the time, without limiting the time, stop charging when the power reaches 100%, and stop discharging when the power reaches 10%. The start and stop SOC of the battery when it is charging or discharging can be set using "Load First Settings". If the inverter is suddenly disconnected, that is, the grid and the battery are all disconnected, the set charge/discharge settings will become invalid.

• **After the Settings are completed,** you need to click the "Setup" button to send instructions.

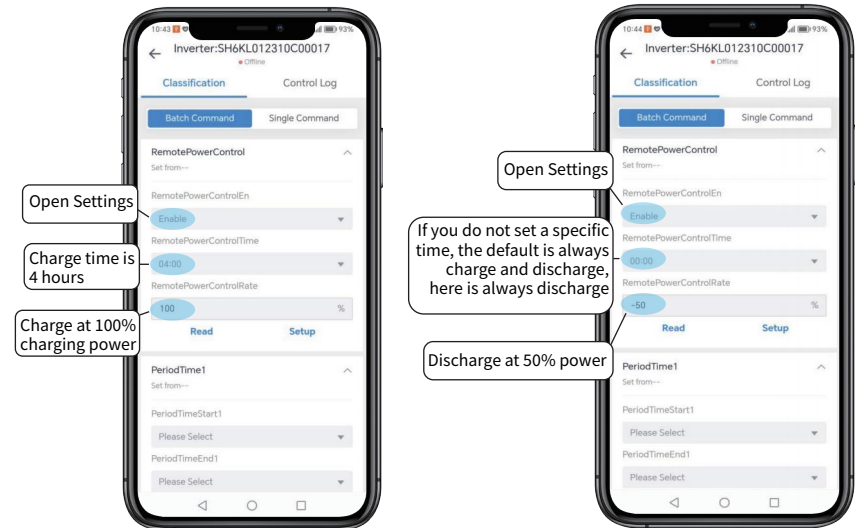

**Note:** If you set fast charge and discharge, the priority period will be invalid. The priority of the fast charge and discharge setting is higher than that of the later priority period setting. When the preset period of fast charge and discharge coincides with a preset priority period, the preset period of fast charge and discharge is activated preferentially.

## Period Time

There are 20 priority periods in the APP, and each period has three setting options.

- **Period N Start time:** The value ranges from 0:00 to 23:59.
- **Period N End time:** The value ranges from 0:00 to 23:59.
- **Period N charge and discharge power:** The range from "-100 to 100" %, from "-100 to 0" % is the discharge power, that is, discharge the battery; 0 to 100 % indicates the charging power, that is, the battery is charged.

1. If you set multiple priority periods, the number of effective depends on the set "number of priority periods".
2. At the same time, in the effective priority period, not in accordance with the set priority period serial number < such as from 1-20 to run in sequence >, but in accordance with the set time period to charge and discharge.

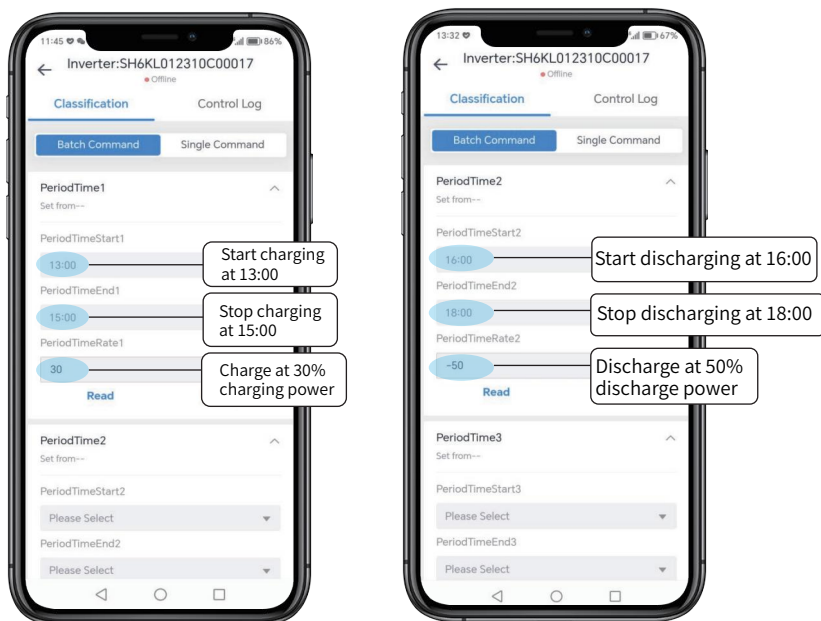

### Note:

1. After setting the priority period, you need to set the number of charge and discharge periods immediately to activate the preset priority period.
2. At the same time, you cannot set two overlapping periods. For example, if you set the time ranges from 0:00 to 01:00 and from 01:00 to 02:00, and the time ranges from 01:00 to 01:00 coincide with each other, you need to set the priority time ranges from 0:00 to 01:00 and from 01:01 to 02:00.
3. When the inverter suddenly loses power, that is, when the grid and battery are all disconnected, the set priority periods are automatically saved.

## Number Time Periods

After setting all the charging and discharging periods, we can set the "Number Time periods" to activate the set charging and discharging periods.

For example, a total of 5 charge and discharge periods are set, but the number "2" is entered in "Number Time Periods", then the first two of the priority periods are activated.

Generally, priority periods are set from period 1 in numerical order (For example, period 1, period 2, period 3...). The charging and discharging periods is also activated in sequence (For example, time period 1, time period 2, time period 3, time period 4, time period 5 is set, but the charging and discharging period is set to 2, then the time period 1 and 2 are activated)

After the setup is complete, you need to click the "Send Command" button to activate the instruction.

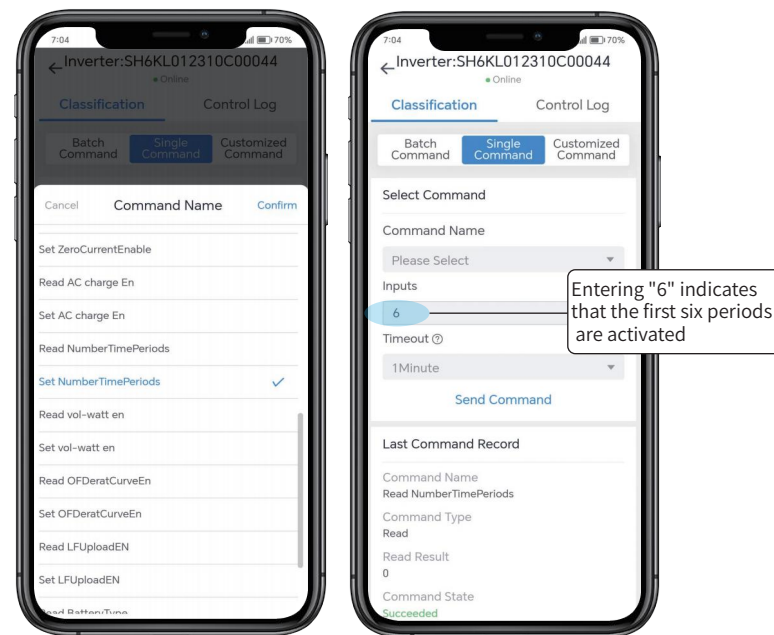

Entering "6" indicates that the first six periods are activated

**Note:** When the "Number Time Periods" is entered as "0" and activated, the preset priority periods will be cleared and need to be reset.

## Prioritization Mode

In the actual use of the inverter, it usually involves the setting of the priority level, and there are generally three priority setting methods: "Load Priority", "Battery Priority" and "Grid Priority".

### Types Of Prioritization Models

- **Load Priority Mode:** The inverter system is turned on to prioritize power to the loads, which can draw power from the grid, PV, or batteries. If "Remote Power Control" and "Period Time" settings are not enabled, the default setting is Load Priority.
- **Battery Priority Mode:** Excess power exists after the inverter system is turned on to satisfy the load, charging the battery is prioritized. In the "Remote Power Control" and "Period Time" settings, the battery priority mode can be turned on if the charging power is set between 0% and 100%.
- **Grid Priority Mode:** Excess electricity that exists after the inverter system is turned on to satisfy the load is prioritized to be discharged to the grid. In the "Remote Power Control" and "Period Time" settings, grid priority mode is turned on if the discharge power is set between -100% and 0%.

### View Priority Mode Status

Click on the inverter you want to view, then click on the "Device Parameters" button and locate "Control" in this screen to display the relevant priority information.

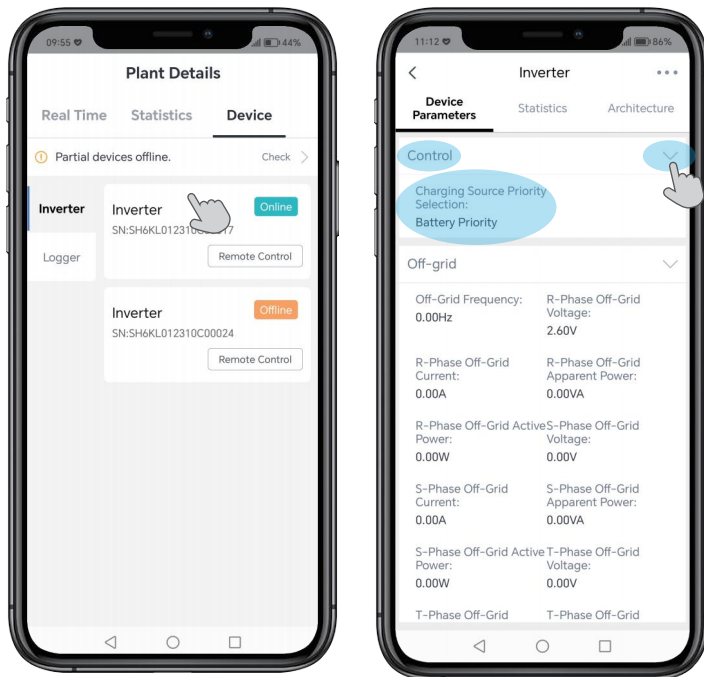

## Set ON/OFF Enable

This is the device start switch. After plugging in the device, the device will enter standby mode and the device will run when the switch is turned on.

Click "Single Command" → "Select Command" → "Command Name", select "Set ON/OFF Enable" function, click "Confirm", and click "On/Off" to open or close the inverter. After the setup is complete, you need to click the "Send Command" button to activate the instruction.

Click "On" and "Confirm" to open the inverter

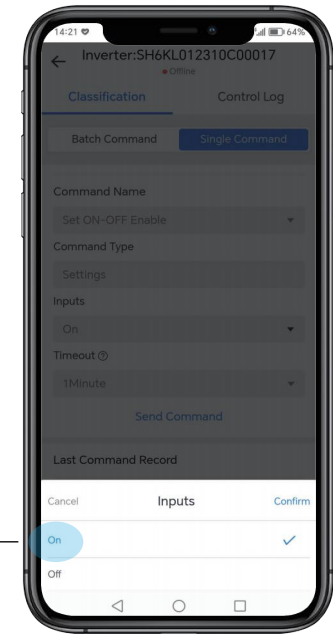

## ⚠ CT Mode

Please select METER/CT Mode according to the actual condition of your equipment.

Click "CT" and "Confirm" to set up CT

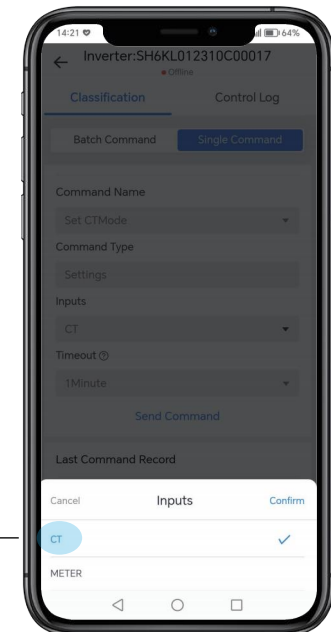

## Anti-Reverse Current Function

In the single command, Anti-Reverse Current function is divided into such as "Read/Set Local Anti-Backflow Enable", "Read/Set Backflow Meter Power Limit", and "Read/Set backflow Fault Power Rate".

### • Local Anti-Backflow Enable:

select **Local Anti Backflow Enable** to limiting the power supplied by the whole system to the power grid. If your equipment is a three-phase inverter, you can select **Three-phase Independent Back Prevention Enable**.

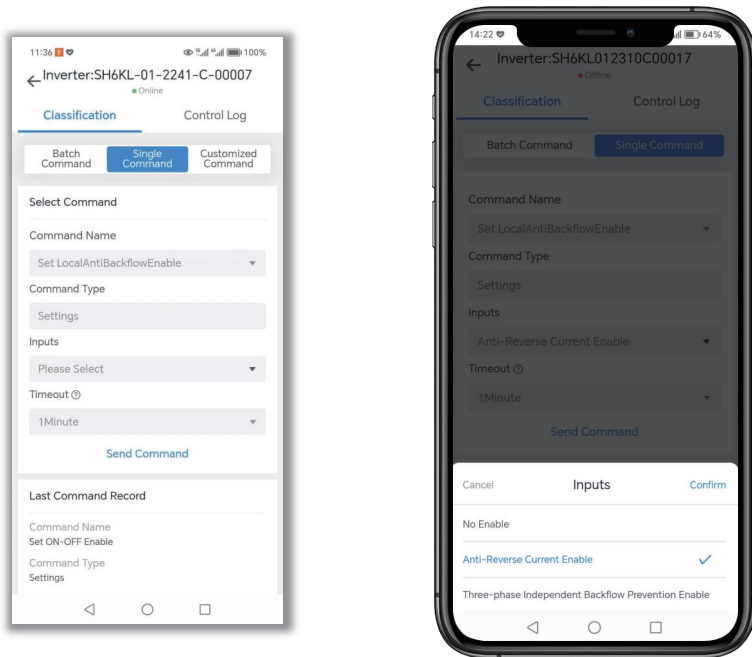

### • Set back flow meter power limit:

After the anti-reverse current function is turned on, and the input is from 0 to 100%, which is mainly to control the grid-connected power of the whole system. "0%" means that the whole system does not supply power to the grid, and "100%" means that the whole system supplies power to the grid with the maximum power.

After turning on the anti-reverse current enable switch, we need to input 0%-100% to limit the grid-connected power.

Taking the 12KW three-phase inverter as an example, inputting 50 % means that the grid-connected power of the whole system is 6000W.

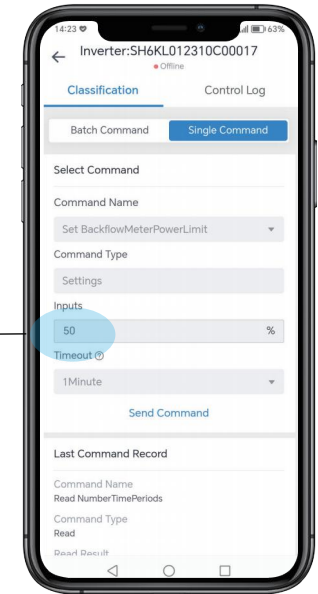

### • Backflow Fault Power Rate:

If a smart meter is used, this setting controls the grid-connected power of the entire system when the smart meter fails or is damaged.

Before we use the back flow fault power rate, we need to turn on the anti-reverse current enable first, and then input 0%-100% to limit the output power of the entire inverter.

Taking a 12KW three-phase inverter as an example, setting 60% means the output power of the whole inverter is 7.2KW, which we can use in the case of meter fault.

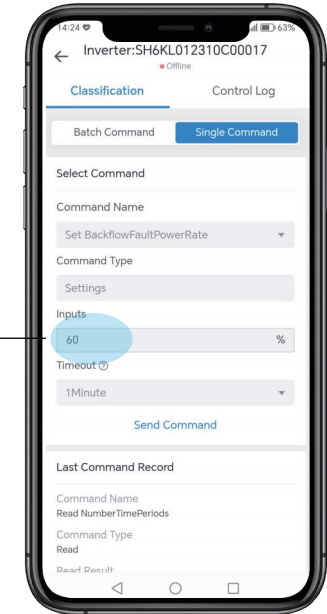

**Note:** Set "Backflow Meter Power Limit" and "Back flow Fault Power Rate" only after the anti-reverse current function is enabled.

No.	Name	Description
1	Read Local Anti-Backflow Enable	Read the current state of the anti-reverse flow enable.
2	Set Local Anti-Backflow Enable	Set "no enable", "single-phase reverse current enable" (for single-phase inverters), "three-phase reverse current enable" (for three-phase inverters).
3	Read Backflow Meter Power Limit	Read current anti-reverse current power rate (access to smart meter or CT).
4	Set Backflow Meter Power Limit	Set current anti-reverse current power rate (access to smart meter or CT).
5	Read Backflow Fault Power Rate	Read current anti-reverse current power rate (when the smart meter fails or is damaged).
6	Set Backflow Fault Power Rate	Set current anti-reverse current power rate (when the smart meter fails or is damaged).

## Battery Protocol Settings

In the "Single Command", we pull down the scroll bar, find the second derivative setting "Set Battery Type", and click "Confirm" after selecting it.

Enter the corresponding battery protocol code (0 to 20) on the following screen.

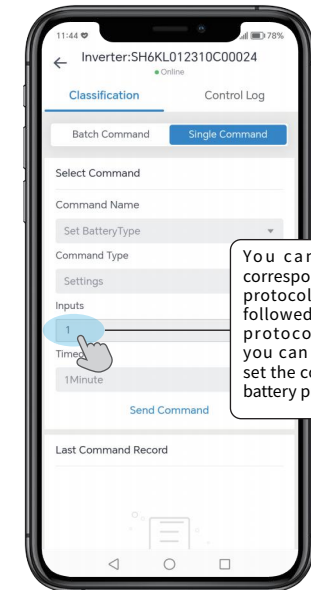
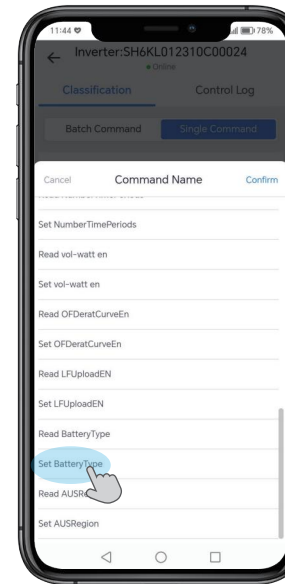

You can enter the corresponding battery protocol code (0-20), followed by a battery protocol appendix, you can refer to and set the corresponding battery protocol.

Enter the number corresponding to the battery protocol and send the command.

Battery Protocol Code		
	Single-phase inverter	Three-phase inverter
0		PYLON Protocol
1		HINEN Protocol
2		Growatt Protocol
3		Growcol Protocol
4		SHOTO Protocol
5		GoodWE Protocol
6		YUZEI Protocol
7-20		Battery 7~20



## 4.8.2 Other Settings

The following settings with "⚠️" are only for users to view and cannot be changed. If you need to change the settings that require professional operation, please contact your installer or HINEN.

### Batch Command

#### ⚠️ Battery Type

There are two options: lead-acid battery and lithium battery. Please select the corresponding battery type according to your device.

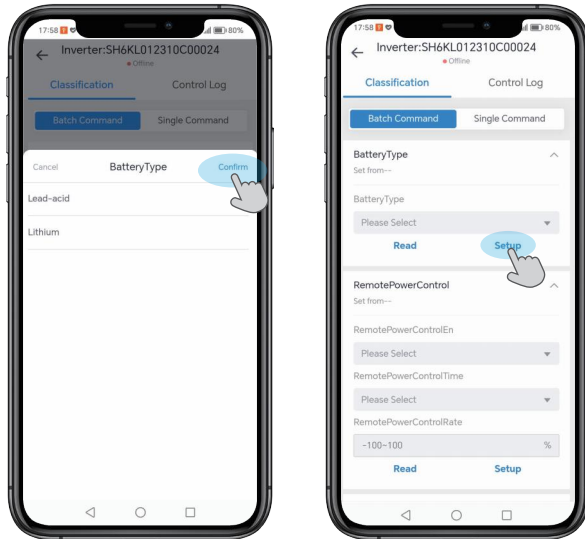

#### ⚠️ First Order Protection

In the first order protection parameters, the main setting is to disconnect the grid when the grid voltage or grid frequency is higher or lower than the set, and protect the circuit. This setting does not affect the use of off-grid load.

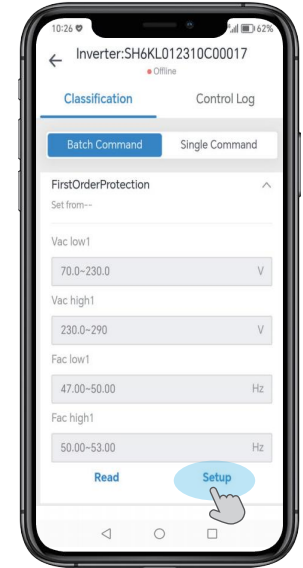

#### ⚠️ Second Order Protection

According to the different safety regulations of each country, the setting and function of the second order protection parameters are the same as that of the first order protection parameters.

In practical application and detection, the second order protection parameters will be detected first. If the second order parameters trigger protection, the first order parameters will not be detected again. If second order protection is not triggered, first order parameters are detected. In short, the higher the order, the higher the priority, both are protection Settings.

**Note:** The first and second order protection parameters are set after the grid connection.

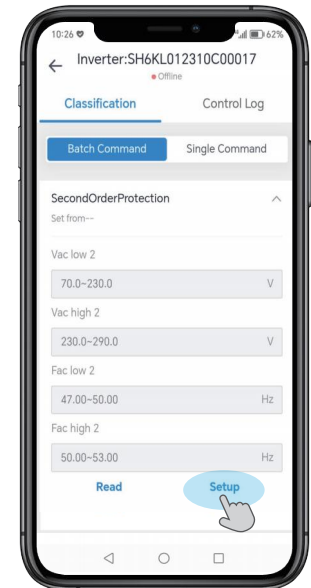

## ⚠ On Line Limit

This setting is before the grid connection, when the grid-connected voltage is within the range of low voltage and high voltage, and at the same time within the low grid frequency and high grid frequency, it can be connected to the grid. Beyond or below this range, the inverter can not be connected to the grid.

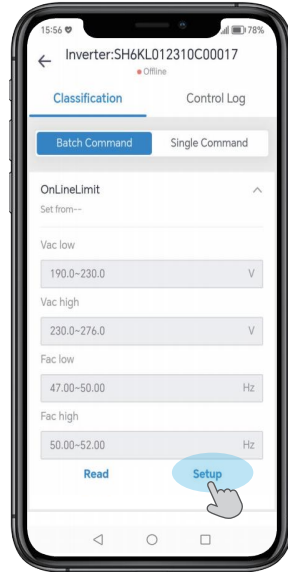

## ⚠ Lead Acid Limit

This setting is set for the battery used by the user. If the user uses a lead-acid battery, it is set according to the relevant parameters of the battery.

- **Float charge current limit** refers to the maximum charge current.
- **Vbat Stop For Discharge** refers to the minimum discharge voltage.
- **Vbat constant charge** refers to the maximum charge voltage.

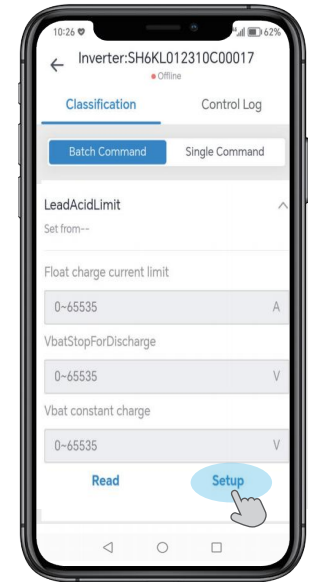

## ⚠ Off Grid Settings

According to the safety regulations of each country are different, you can set the corresponding off-grid voltage and off-grid frequency according to the safety requirements of the user.

Off-grid voltage has 230V/240V/208V three voltage range options, off-grid frequency has 60Hz/50Hz two frequency range options.

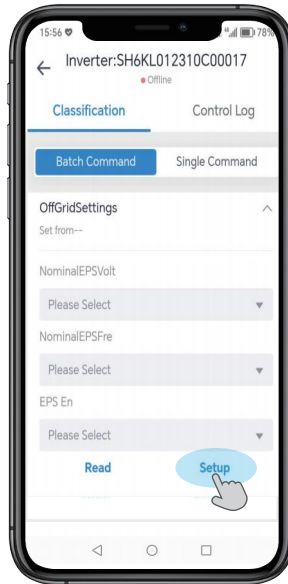

## ⚠ Load First Settings

This is a setting for the battery, which is performed in the load priority mode. (For details on priority settings, refer to "Prioritization Mode" in "Common Settings".)

- **Load Frist Charge Rate & Load Frist Discharge Rate** refers to the charging/discharging power of the battery with load priority.
- **Bat Frist stop SOC** refers to charging the battery to the set SOC value to stop charging. If the PV is turned on, the battery is charged for the PV and the grid together.
- **Grid First Stop SOC** means the battery is discharged to the grid up to the set SOC value to stop discharging.
- **Load Frist Stop SOC** means the battery is discharged to the load up to the set SOC value to stop discharging.

The battery is charged/discharged at the set power with load priority.

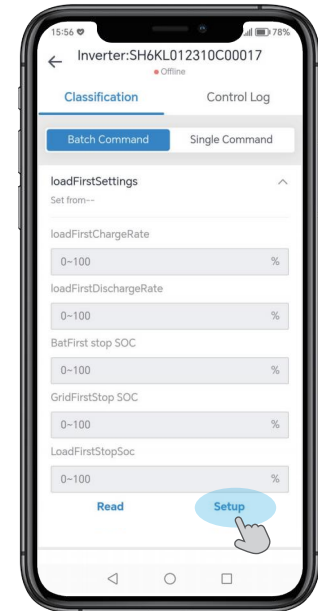

\***SOC**: State of Charge, refers to the available state of charge remaining in the battery.

## PF Model

Power Factor (applicable to specific countries, please refer to local grid requirements).

Mode	Comment
Off	/
FixedPFSetMode	Power factor
UserSetLinePFMode	/
ConstQLeadPFMode	Q_Percentage
ConstQLagPFMode	Q_Percentage
Q(P)PFMode	QP_p1 Rate
Q(u)PFMode	QU_PercentMax
	QU_Q2Percent
	QU_Q3Percent
	QU_PercentMin
	QU_UV_Stop
	QU_UV_Start
	QU_OV_Start
	QU_OV_Stop
Qu Delay Time	
Qu Lock in Power	
Qu Lock Out Power	
DefaultLine2RunPFMode	/
Static_QLeadPFMode	/
Static_QLagPFMode	/

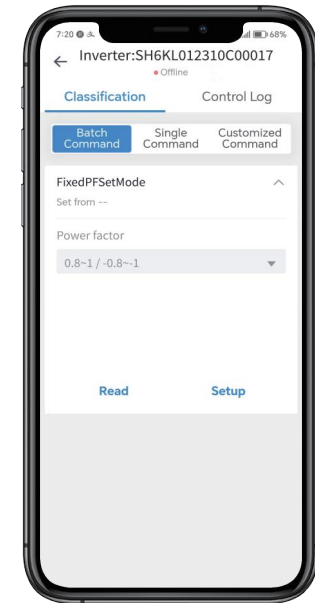
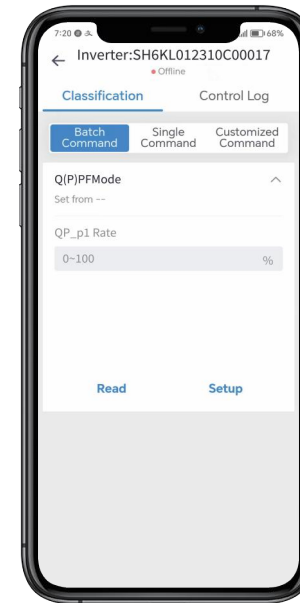
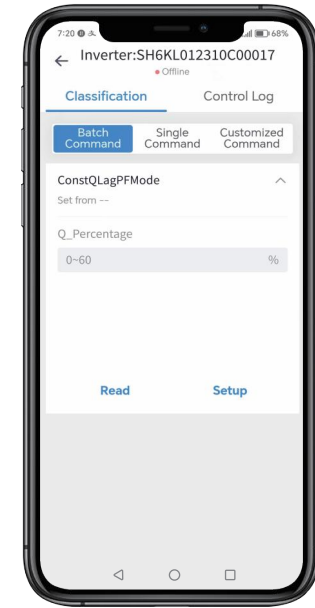
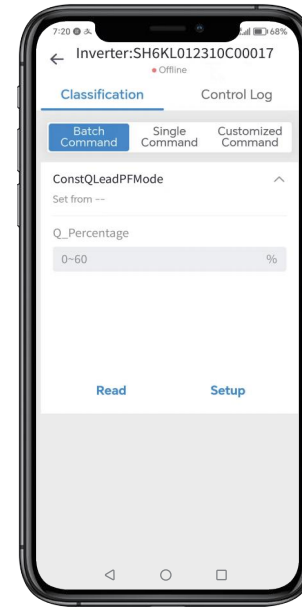
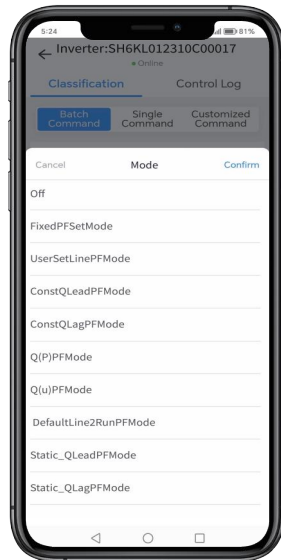
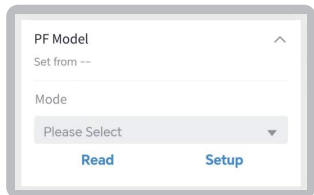

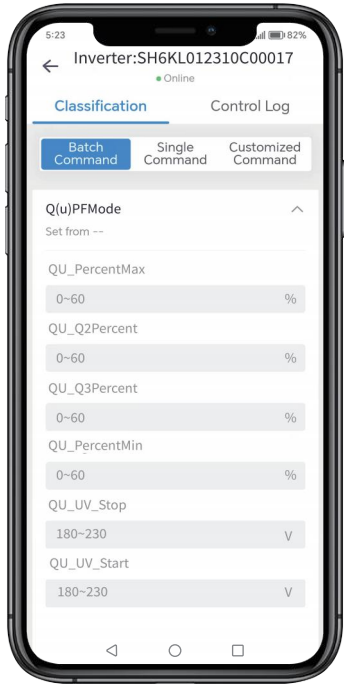

## Volt-watt

Mode	Comment
Voltage active work	PU_Enable
	PU_VL_Stop
	PU_VL_Start
	PU_VH_Start
	PU_VH_Stop
	PU_VLStopPower
	PU_VLStartPower
	PU_VHStartPower
	PU_VHStopPower
	PU_DelayTime

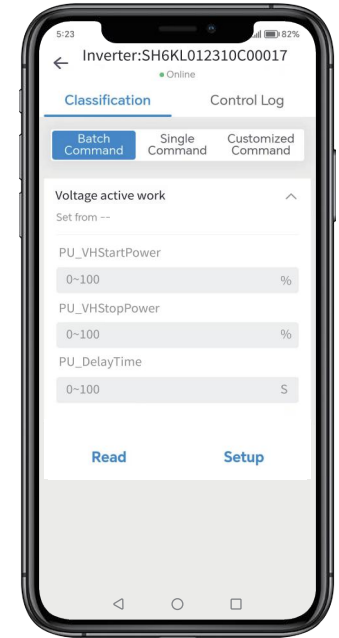
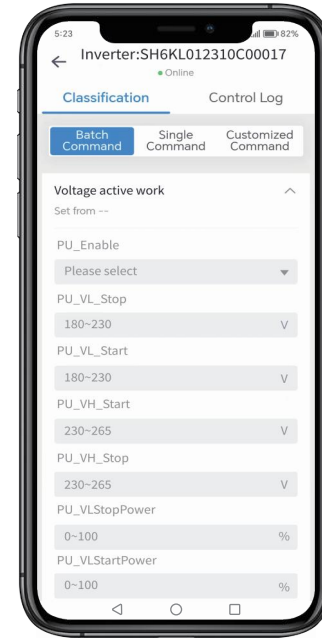

Mode	Comment
Power Restart Slope EE	Power Restart Slope EE (1-1000%/min)
Active Power Rate Slope EE	Active Power Rate Slope EE (1-1000%/min)
Active Power Percent	Active Power Percent (0-100%)

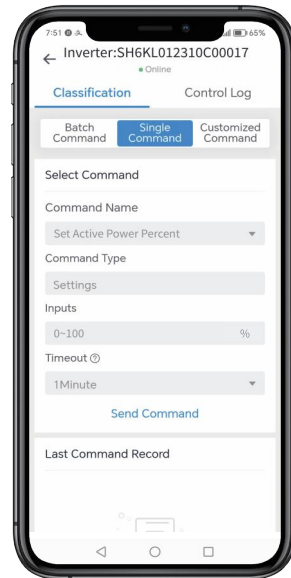
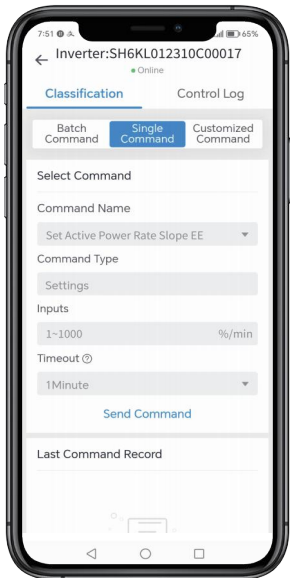
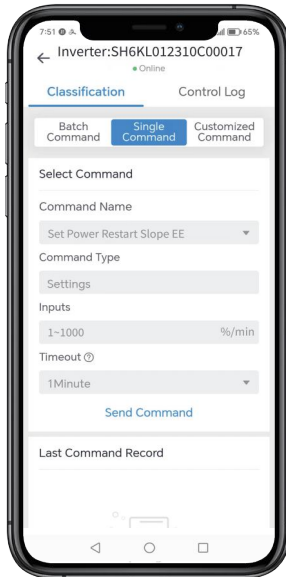

Reactive power control, reactive power standard curve  $\cos \varphi = f(P)$

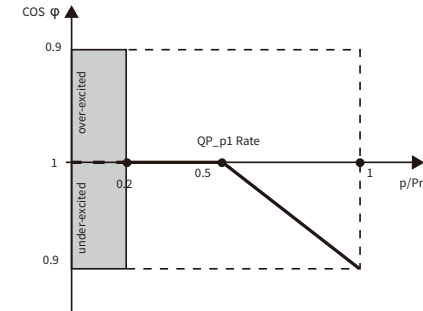

Reactive power control, reactive power standard curve  $Q = f(V)$

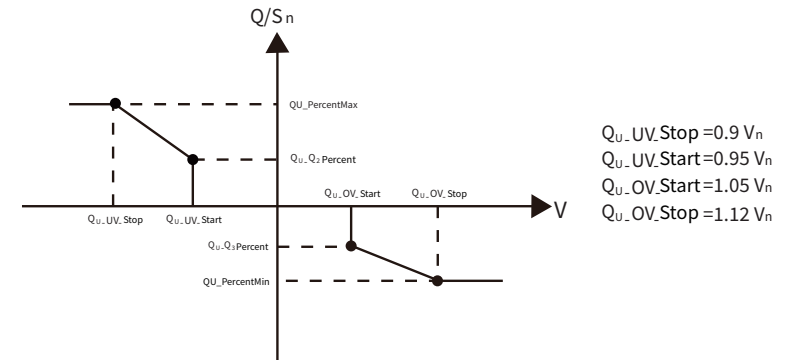

Active power control, active power standard curve  $P = f(V)$

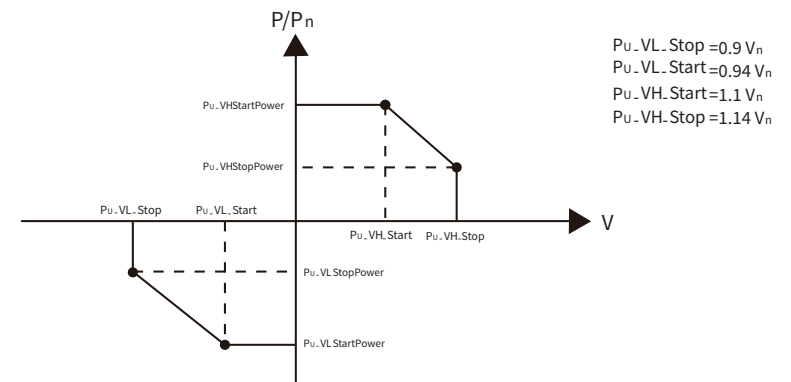

## Single Command

### Anti-islanding Enable

The inverter uses the active frequency drift (AFD) method, also known as frequency biasing, to prevent the islanding effect.

The anti-islanding enable is on by default, so please select it carefully in order to protect equipment and personnel from harm!

\* The islanding effect means that when the power grid is cut off, the grid-connected power generation system fails to detect the power outage and still supplies power to the power grid. This is very dangerous for the maintenance personnel and the power grid on the transmission line.

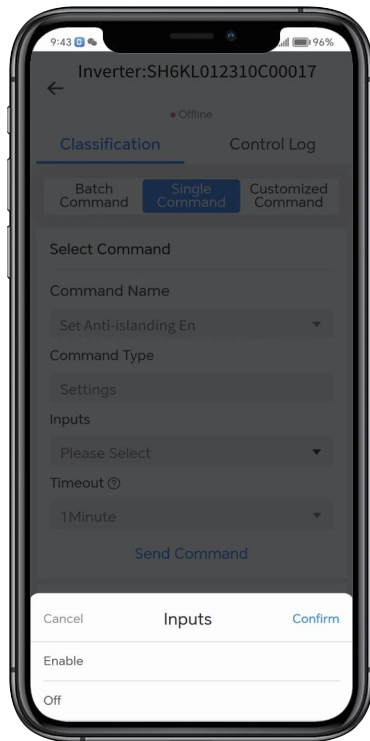

### Power Control

Power control Power control, divided into Active P Rate and Reactive P Rate, selectable range is 0%-100%.

**Active P Rate** refers to the output active power, which is the electric power needed to maintain the normal operation of electrical equipment.

**Reactive P Rate** refers to the output reactive power, which does not consume electric energy in the grid, and is an essential power in the grid.

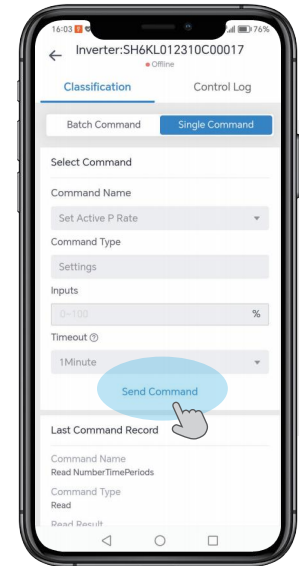

### Zero Current Enable

- If before the first and second protection times of the grid, if the voltage is too high or too low, the current will drop to zero.

- If within the first and second protection times of the grid, the voltage will return to normal, and the current will also return to normal.

- If the first and second protection times of the grid are exceeded, the grid will be disconnected.

- If the voltage is too high or too low for a short period of time, the current will drop to zero instantly.

- After the voltage returns to normal, the current will also return to normal.

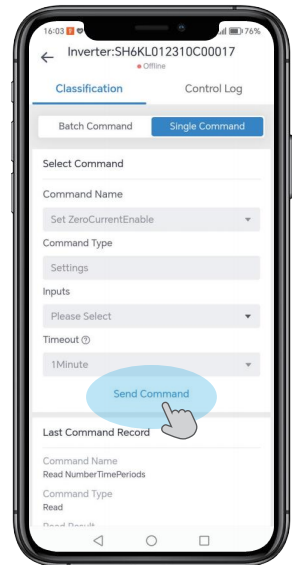

## AC Charge Enable

When AC Charging is enabled, it will allow the grid to charge the batteries.

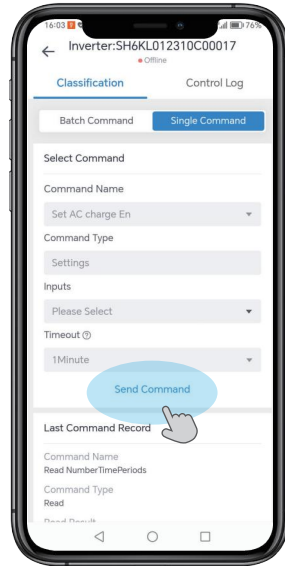

## OFDerat Curve Enable

This is "Over frequency load reduction Enable" setting. When it is enabled, the active power of the grid begins to decrease when the frequency reaches a certain value.

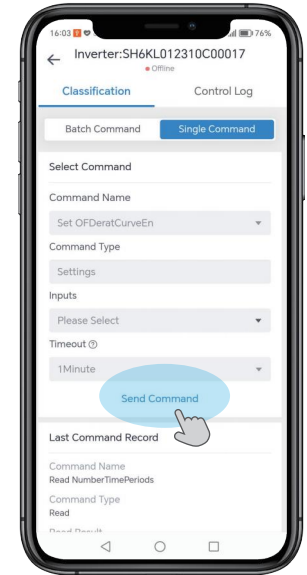

## Voltage-watt Enable

This is "Voltage Active Enable" setting. When the voltage reaches the overvoltage or undervoltage point, the active power starts to decrease until the voltage reaches the end point of the overvoltage or undervoltage, and the power reaches the end point.

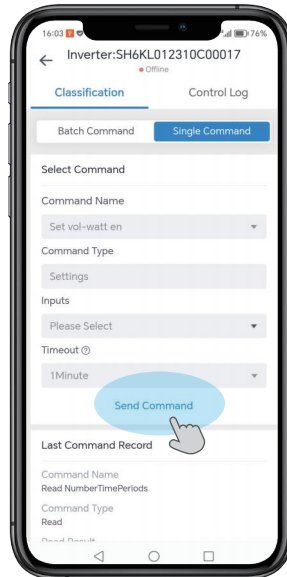

## LFUpload Curve Enable

This is "Under frequency load increase Enable" setting. When it is enabled, the active power of the grid starts to rise when the frequency reaches a certain value.

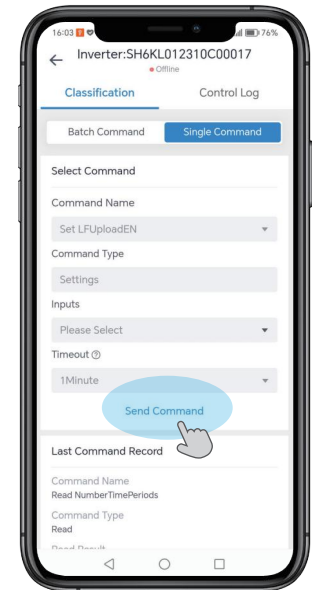

## AUS Region

This setting is for the safety of different regions in Australia. If the customer is an Australian customer, the setting is based on the customer's region. There are four main regions: A, B, C and NZ. (NZ stands for New Zealand region).

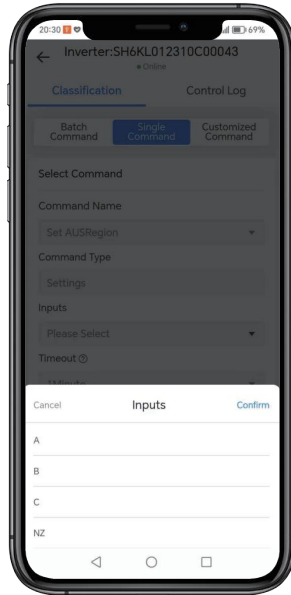

Regional application Standard	Electric Company
Australia A	N/A
Australia B	N/A
Australia C	N/A
New Zealand	N/A

### Notice:

1. For compliance with AS/NZS 4777.2:2020 please select from Australia A/B/C. Please contact your local electricity grid operator for which region to select.
2. For changes to default settings please contact the installer or HINEN.

For installers, the specific steps to set up this command are as follows:

- 1 Find "Set AUSRegion" in the "Single Command".



- 2 Select and click "Confirm".

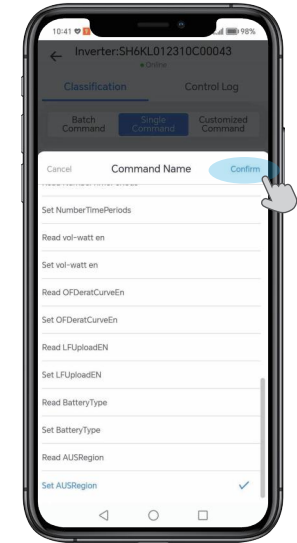

- 3 Select the input box.

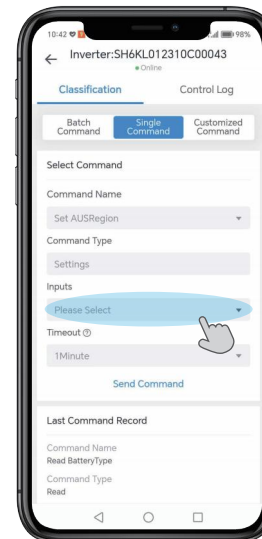

- 4 Select the region where the inverter is installed and click "Confirm".

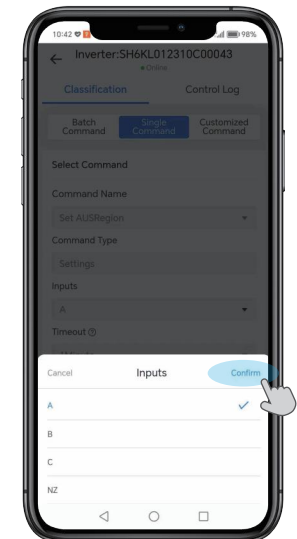



5 Click "Send Command" to complete the setup.

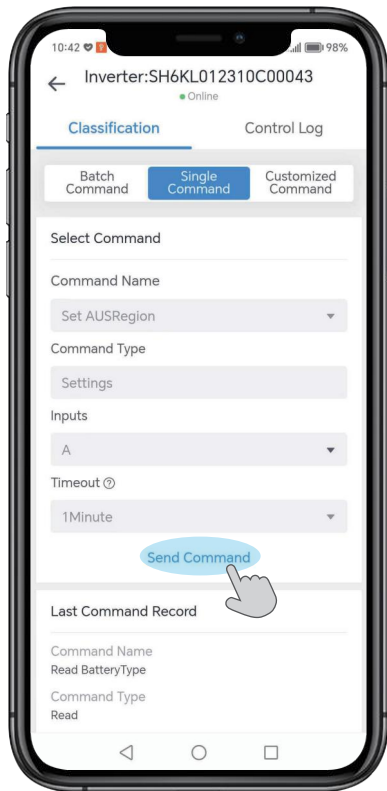

## 4.9 Trouble codes

### 4.9.1 Fault reference code

Main Fault Code	Inverter State	Fault Discription	Suggestion
Error 108	Error/Off	NTC Temperature too high	1. After shutdown,Check the temperature, normal restart the inverter. 2. If the error message still exists, contact manufacturer.
Error 109	Error/Off	Bus voltage abnormal	1. Restart inverter. 2. If error message still exists,contact manufacturer.
Error 110	Error/Off	Communication fault	1. After shutdown,Check communication board wiring. 2. If the error message still exists, contact manufacturer.
Error 113	Error/Off	Over current protected by software	1. Restart inverter. 2. If error message still exists,contact manufacturer.
Error 114	Error/Off	Over current protected by software	1. Restart inverter. 2. If error message still exists,contact manufacturer.
Error 116	Error/Off	GFCI Module damage	1. After shutdown,Check the leakage current module. 2. If the error message still exists, contact-manufacturer.
Error 121	Error/Off	buck_boost current Abnomal	1. Restart inverter. 2. If error message still exists,contact manufacturer.
Error 123	Error/Off	BUS balance current Abnomal	1. Restart inverter. 2. If error message still exists,contact manufacturer.
Error 206	Error/Off	Leakage current too high	1. Restart inverter. 2. If error message still exists,contact manufacturer.
Error 207	Error/Off	DCI too high	1. Restart inverter. 2. If error message still exists,contact manufacturer.
Error 208	Error/Off	AC active Power too high	1. Restart inverter.reduce Eps Load 2. If error message still exists,contact manufacturer.

Main Fault Code	Inverter State	Fault Discription	Suggestion
Error 300	Error/Off	EPS OP Short Fault	1. Restart inverter. 2. If error message still exists,contact manufacturer.
Error 401	Error/Off	The DC input voltage is exceeding the maximum tolerable value	1. Immediately disconnect the DC switch and check the voltage. 2. If the fault code still exists after the normal voltage is restored, contact manufacturer.
Error 402	Error/Off	PV Isolation Low	1. After shutdown,Check if panel enclosure ground properly. 2. If error message still exists,contact manufacturer.
Error 403	Error/Off	The DC input current is exceeding the maximum tolerable value.	1. After shutdown,Check if panel enclosure ground properly. 2. If error message still exists,contact manufacturer.
Error 500	Error/Off	BMS Communication fault	1. Check 485 cable between SP and battery. 2. Check if battery is sleeping. 3. If error message still exists,contact manufacturer.
Error 502	Error/Off	Battery voltage low	1. Check battery voltage. 2. If error message still exists,contact manufacturer.
Error 503	Error/Off	Battery Voltage High	1. Check whether the battery voltage too high; if battery OK, please restart the inverter; if not, please replace battery. 2. If error message still exists,contact manufacturer.
Error 504	Error/Off	Battery temperature out of specified range for charge or discharge	1. Check battery temperature. 2. If error message still exists,contact manufacturer.
Error 505	Error/Off	Battery terminals reversed	1. Check battery terminals. 2. If error message still exists,contact manufacturer.
Error 506	Error/Off	Battery terminal open (only for lithium battery)	1. Check battery terminal. 2. If error message still exists,contact manufacturer.
Error 508	Error/Off	Bat Relay Fault	1. Restart inverter. 2. If error message still exists,contact manufacturer.

#### 4.9.2 Warning reference code

Main Warning Code	Inverter State	Warning Discription	Suggestion
Warning 1102	Warning/On	Optimizer and inverter communication is abnormal	1. Check if the meter is reversed or not. 2. Check the machine and the meter connection is normal.
Warning 1103	Warning/On	Optimizer and inverter communication is abnormal	1. Check if the optimizer is on. 2. Check whether the connection between the optimizer and the inverter is normal.
Warning 1104	Warning/Off	Bus voltage Low	1. Restart inverter. 2. If error message still exists,contact manufacturer.
Warning 1105	Warning/Off	EPS Relay Open	1. Restart inverter. 2. If error message still exists,contact manufacturer.
Warning 1200	Warning/On	No Utility	1. Please confirm grid is lost or not. 2. If error message still exists,contact manufacturer.
Warning 1201	Warning/On	Grid voltage outrange	1. Check the AC voltage is in the range of standard voltage in specification. 2. If error message still exists,contact manufacturer.
Warning 1202	Warning/On	Grid frequency outrange	1. Check the frequency is in the range of specification or not. 2. If error message still exists,contact manufacturer.
Warning 1204	Warning/On	Smart Meter Communication Abnormal	1. Check if AC current sensor is connected well. 2. If error message still exists,contact manufacturer.
Warning 1207	Warning/On	Grid Phase outrange	1. Check R/S/T phasewire. 2. If error message still exists,contact manufacturer.
Warning 1302	Warning/On	Off-grid output voltage is too High	1. Restart inverter. 2. If error message still exists, contact manufacturer.
Warning 1303	Warning/On	Off-grid output voltage is too low	1. Restart inverter. 2. If error message still exists, contact manufacturer.
Warning 1304	Warning/Off	EPS OP OverLord Warning	1.Restart inverter. 2. If error message still exists,contact manufacturer.

Main Warning Code	Inverter State	Warning Discription	Suggestion
Warning 1404	Warning/On	Dryconnect function abnormal	1. After shutdown,Check the dry Dryconnect wiring. 2. If the error message still exists, contact manufacturer.
Warning 1501	Warning/On	Battery terminal open (only for lithium battery)	1. Check the battery is connected. 2. If error message still exists,contact manufacturer.
Warning 1503	Warning/On	Battery temperature outrange	1. Check the environment temperature of battery is in the range of specification or not. 2. If error message still exists,contact manufacturer.
Warning 1504	Warning/On	Lithium battery Over Load warning	1. Check whether output load over Lithium battery rate power; If load too large, please reduce load. 2. If error message still exists, contact manufacturer.
Warning 1505	Warning/On	Lithium battery only charge warning	1. Check whether output load over Lithium battery rate power; If load too large, please reduce load. 2. If error message still exists, contact manufacturer.
Warning 1506	Warning/On	Lithium battery need charge warning	1. Check whether output load over Lithium battery rate power; If load too large, please reduce load. 2. If error message still exists, contact manufacturer.
Warning 1507	Warning/On	Lithium battery charge full warning	1. Check whether output load over Lithium battery rate power; If load too large, please reduce load. 2. If error message still exists, contact manufacturer.
Warning 1508	Warning/On	Lithium battery disable charge for bus High warning	1. Check whether output load over Lithium battery rate power; If load too large, please reduce load. 2. If error message still exists, contact manufacturer.
Warning 1509	Warning/On	Lithium battery disable discharge for bus High warning	1. Check whether output load over Lithium battery rate power; If load too large, please reduce load. 2. If error message still exists, contact manufacturer.
Warning 1510	Warning/On	Temperature sensor connection is abnormal	1. After shutdown,Check the temperature sampling module is connected properly. 2. If the error message still exists, contact manufacturer.

Main Warning Code	Inverter State	Warning Discription	Suggestion
Warning 1511	Warning/Off	Battery voltage low	1. Check battery voltage 2. If error message still exists,contact manufacturer.

## 4.10 Troubleshoot

### Check before AC power-on

- Battery connection: Make sure that the polarity (+/-) is connected correctly when connecting the inverter to the battery, see Figure 1.
- PV input connection: Make sure the polarity (+/-) connection is correct when connecting the inverter and battery, see Figure 2.
- Grid-connected and off-grid connection: Make sure that the polarity is correct when connecting the grid-connected side to the grid and the off-grid side to the load, and the R wire, S wire, T wire and N wire are connected in sequence, see Figure 3.

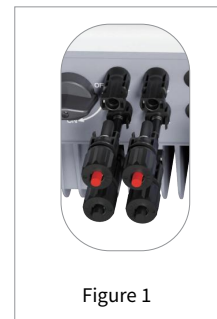

Figure 1

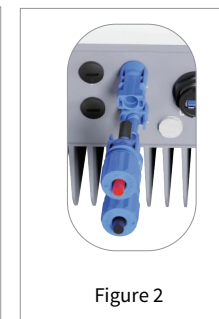

Figure 2

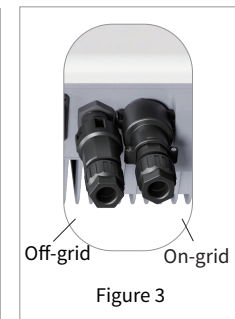

Figure 3

### Check before start-up and AC power-on

#### Battery Settings, BMS Communication and Security Country:

After connecting the data logger, please check the parameters in the SOLARMAN Smart app to make sure the selected battery type is the same as the one you installed, and the safety country is selected correctly. If it is not set correctly, please set it correctly in the settings.

**Note:** For compatible lithium batteries, after selecting the correct battery manufacturer, the BMS status will display "Normal".

## Operational problems

Operational problems	Solution
Cannot start with PV.	<ol style="list-style-type: none"> <li>1. Make sure the photovoltaic voltage is higher than 140V.</li> <li>2. Make sure that the polarity (+/-) is not reversed when connecting the inverter and PV panel.</li> </ol>
The inverter outputs when it is off-grid and does not discharge .	<ol style="list-style-type: none"> <li>1. Make sure the state of discharge (SOC) is higher than I-DOD (depth of discharge). If the battery is discharged below I-DOD, it will only be discharged again when the SOC charge is greater than <math>(20\%+I-DOD)/2</math> and <math>SOC&gt;105\%-DOD</math>.</li> <li>2. Check whether the charging time has been set on the APP, because the battery will not discharge during charging. The battery will be charged preferentially when the charging and discharging time is consistent.</li> </ol>
The battery does not charge when the PV power is higher than the load power.	<ol style="list-style-type: none"> <li>1. Check the discharge time setting in SOLARMAN Smart.</li> <li>2. Check whether the battery is fully charged, or whether the battery voltage reaches the charging voltage.</li> </ol>
High power fluctuations when charging or discharging the battery.	<ol style="list-style-type: none"> <li>1. Check whether the load power fluctuates.</li> <li>2. Check whether the PV power fluctuates.</li> </ol>
The battery is not charging.	<ol style="list-style-type: none"> <li>1. If it is a lithium battery, please check the SOLARMAN Smart to ensure that the BMS communication is normal.</li> <li>2. Check whether the smart meter is connected in the correct position and in the right way.</li> <li>3. Check whether the total load power is much higher than the PV power.</li> </ol>

## Q & A

### About SOLARMAN Smart Operation and Monitoring

#### 1. Why can't I find a Solar-WiFi\* signal on my mobile device?

Normally, the inverter can search for Solar-WiFi\* signal after it is powered on. But when the inverter is connected to the internet, the Solar-WiFi signal disappears. If you need to change settings, connect to your router to make changes. If you can't find a WiFi signal or can't connect to your router, please reload your WiFi.

#### 2. Why can't my phone connect to the Solar-WiFi\* signal?

The WiFi module can only connect to one device at a time. If a WiFi signal is already connected to another device for some reason, you cannot connect to it.

#### 3. Why can't the WiFi module connect to the network after selecting the correct router hotspot and entering the correct password?

It may be that there are special characters in the hotspot password that the module does not support. Please modify the password to contain only Arabic numerals or upper/lower case letters.

#### 4. Why can't I save the settings on the SOLARMAN Smart app?

Probably disconnected from Solar-WiFi\*.

(1) Make sure you have connected Solar-WiFi\* (make sure no other devices are connected) or a router (if connecting Solar-WiFi\* to a router). The home page of the App shows that the connection is good.

(2) Restart the inverter 10 minutes after changing some settings, because in normal mode the inverter will save the settings every 10 minutes. We recommend changing the setup parameters while the inverter is in standby mode.

#### 5. Why is the data displayed on the home page different from the data displayed on the parameter page, such as charge and discharge, PV value, load value or grid value?

The data refresh frequency is different, so there will be data inconsistencies between different pages of different apps, and between web pages and app pages.

#### 6. Why do some columns show NA, such as battery SOH, etc.?

NA means that the app is not accepting data from the inverter or the server due to communication problems, such as battery communication problems, communication problems between the inverter and the app.

## About battery operation

---

### 1. Why does the battery not discharge when the grid is not available, but it can discharge normally when the grid is available?

Turn on the off-grid output and off-grid function on the APP to discharge the battery in off-grid mode.

### 2. Why did the battery SOC suddenly jump to 95%?

Generally, the lithium battery BMS communication fails. If the battery goes into top-up mode, the SOC will automatically reset to 95%.

### 3. Why is there no output from the off-grid terminal?

For off-grid power, you must turn on "Off-Grid Power" on the SOLARMAN Smart app. In off-grid mode or when the power grid is cut off, the "off-grid output switch" function must also be turned on.

**Note:** For "off-grid output switch", please do not restart the inverter or battery, otherwise the function will be automatically turned off.

### 4. Why does the battery always trip when it starts up (lithium battery)?

The usual reasons for a lithium battery switch trip are as follows:

- (1) BMS communication failed.
- (2) The battery SOC is too low, and the battery trips to protect itself.
- (3) Electrical short circuit on battery connection side.

If you still have problems after checking the above reasons, please contact the after-sales service.

### 5. What kind of battery should I use for the inverters?

The inverter can be connected with a compatible lithium battery with a nominal voltage of 120-600V. The BAT port input rated voltage of the inverter is 500V, so it is recommended to use a compatible lithium battery rated at 500V. For compatible lithium batteries, please refer to the battery list in the SOLARMAN Smart app.

## About Smart Meter Functions

---

### 1. How to enable the output anti-reverse current function?

For the inverter system, this function can be realized in the following ways:

- (1) Make sure the smart meter connection and communication are good.
- (2) Turn on the anti-reverse current function on the App, and set the maximum allowable backflow power to the grid on the App.

**Note:** Even if the allowed reverse current power limit is set to 0W, there may still be a maximum deviation of about 100W in the power output to the grid.

### 2. Why is there still power output to the grid after I set the power limit to 0W?

The output limit can be 0W in theory, but there will be a deviation of about 50-100W for the inverter system.

### 3. Can I use other brands of meters to replace the smart meters in the inverter system or modify some settings of the smart meters?

Cannot. Because inverters and smart meters integrate communication protocols, other brands of meters cannot communicate. Additionally, any manual setting changes may cause meter communication failures.

## Other problems

---

### 1. Is there a way to get the system to work quickly?

Please refer to this user manual.

### 2. What kind of load can be connected to the back-up side?

It can be connected to critical loads in the home, such as refrigerators, computers, lights, etc. Please note that the load power cannot exceed the specification.

### 3. Is the warranty of the inverter still valid if it is not installed or operated 100% according to the instructions in the user manual in some special cases?

In general, we will still provide technical support for problems caused by failure to follow the instructions in the user manual, but we cannot guarantee that the product can still be returned or exchanged. Therefore, if you cannot follow the instructions 100% under special circumstances, please contact after-sales consultation.

## 5. Other

### 5.1 Fault details

When a fault occurs, the following error information can be viewed through SOLARMAN Smart.

Error message	Explanation	Reason	Solution
Utility loss	Grid power is unavailable (power failure or grid connection failure).	The inverter does not detect grid information.	<ol style="list-style-type: none"> <li>1. Use a multimeter to check whether there is voltage on the AC side, and ensure that the power grid is available.</li> <li>2. Make sure the AC cable is firmly connected.</li> <li>3. If everything is ok, try disconnecting the AC breaker and reconnecting it after 5 minutes.</li> </ol>
VAC failure	The grid voltage is out of the allowable range.	The inverter detects that the AC voltage exceeds the normal range required by safety regulations.	<ol style="list-style-type: none"> <li>1. Make sure the safety country setting of the inverter is correct.</li> <li>2. Use a multimeter to check whether the AC voltage between the R wire, S wire, T wire, and N wire on the side of the AC circuit breaker is within the normal range. *If the AC voltage is high, please ensure that the length of the AC cable is not too long, and the specifications meet the requirements in the user manual. *If the AC voltage is low, please ensure that the AC cable is well connected and the protective cover is not pressed into the AC terminal.</li> <li>3. Make sure the grid voltage in your area is stable and within normal limits.</li> </ol>
FAC failure	Grid frequency is out of allowable range.	The inverter detects that the grid frequency exceeds the normal range required by safety regulations.	<ol style="list-style-type: none"> <li>1. Make sure the safety country setting of the inverter is correct.</li> <li>2. If the safety country is set correctly, please check whether the AC frequency (Fac) of the inverter is within the normal range.</li> <li>3. If FAC failures are rare and resolved quickly, occasional grid frequency instability may be the cause.</li> </ol>
Over temperature	Inverter internal temperature is too high.	Inverter working environment temperature is too high.	<ol style="list-style-type: none"> <li>1. Keep the surrounding temperature as low as possible.</li> <li>2. Make sure to follow the installation instructions in the user manual.</li> <li>3. Try turning off the inverter for 15 minutes and then turning it on again.</li> </ol>
Isolation failure	There may be many reasons for isolation failure, such as poor grounding of photovoltaic panels, broken DC cables, aging of photovoltaic panels or moderately large surrounding areas, etc.	There may be many reasons for isolation failure, such as poor grounding of photovoltaic panels, broken DC cables, aging of photovoltaic panels or high ambient humidity, etc.	<ol style="list-style-type: none"> <li>1. Use a multimeter to check if the resistance between the ground and the inverter frame is close to 0, if not, make sure the wiring is good.</li> <li>2. Isolation failure may occur if humidity is too high.</li> <li>3. Check the resistance of PV1+/ PV2+/BAT+/PV-to ground, if the resistance is lower than 33.3K, please check the system wiring.</li> <li>4. Please try to restart the inverter and check if the fault still exists. If the fault disappears, it is an accidental situation, otherwise please contact the after-sales service.</li> </ol>
Ground failure	Ground leakage current is too high.	The ground fault may be caused by various reasons such as the AC side N-wire not being connected properly or the surrounding humidity is high.	<ol style="list-style-type: none"> <li>1. Keep the surrounding temperature as low as possible.</li> <li>2. Make sure to follow the installation instructions in the user manual.</li> <li>3. Use a multimeter to check if there is voltage between the ground and the inverter frame. In general, the voltage should be close to 0. If there is voltage, it means that the N wire and the ground wire on the AC side are not connected properly. If this fault occurs in the early morning/dawn/rainy day with high air humidity and recovers soon, it should be normal.</li> </ol>
DC bus high	BUS voltage is too high.		Try restarting the inverter and check if the fault persists. If the fault does not exist, it is an occasional condition. Otherwise, please contact the after-sales service immediately.
Back-up over load	Back-up side over load	The back-up load power is higher back-up rated output power.	Reduce the off-grid load to ensure that the total load power is lower than the off-grid rated output power.

## 5.2 Hazard avoidance quick checklist

1. Do not install the inverter near flammable, explosive or strong electromagnetic equipment.
2. The inverter is heavy, be careful when taking it out of the bag.
3. Before connecting the battery to the inverter, ensure that the battery circuit breaker is disconnected, and the nominal voltage of the battery meets the requirements of safety regulations, and ensure that the inverter is completely isolated from the photovoltaic and AC power sources.
4. Before connecting the AC cables, make sure the inverter is completely isolated from any DC or AC power source.
5. Before connecting the smart meter, make sure the AC cable is completely isolated from the AC power.

Appendix: Definition of protection level

### Definition of Overvoltage Classification

Level I overvoltage	Equipment suitable for connection to circuits in which measures are taken to limit transient overvoltages to low levels.
Level II overvoltage	Applies to equipment not permanently attached to a fixed installation. For example, appliances, portable tools and other plug-in devices.
Level III overvoltage	Applicable to equipment permanently connected in fixed installations (i.e. equipment installed downstream of the power switchboard, including the switchboard itself), e.g. switches and other equipment in industrial installations.
Level IV overvoltage	Applicable to equipment that has been permanently connected at the start of the installation (i.e. equipment installed upstream of the power distribution panel), for example, electricity meters, primary overcurrent protection equipment and other equipment directly connected to outdoor power lines.

### Wet Location Class Definitions

Humidity parameter	Grade		
	3K3	4K3	4K4H
Temperature	0~+40°C	-33~+40°C	-20~+55°C
Humidity	5%~85%	15%~100%	4%~100%

### Environmental Class Definition

Environmental conditions	External temperature	Relative humidity	Apply to
Outdoor	-20~50°C	4%~100%	PD3
Indoor, unregulated	-20~50°C	5%~95%	PD3
Indoor, regulated	0~40°C	5%~85%	PD2

### Definition of Pollution Level

Pollution degree 1	No pollution or only dry non-conductive pollution.
Pollution degree 2	Normally only non-conductive pollution, but occasional transient conductivity due to condensation must be taken into account.
Pollution degree 3	Conductive pollution, or dry non-conductive pollution becoming conductive due to expected condensation.
Pollution degree 4	Cause persistent conductive pollution, such as pollution caused by conductive dust or rain and snow.

## 5.3 Maintenance

### 5.3.1 Maintenance details

#### Inverter should be maintained regularly, details as below.

Before maintenance, make sure that the inverter is totally isolated from both PV and AC power for at least 5 minutes.

**Heat sink:** please use a clean towel to clean the heat sink every year.

**Torque:** use a torque wrench to tighten the AC and DC connections every year.

**DC breaker:** check the DC breaker regularly and turn the DC switch on and off for ten consecutive times every year to make sure that it is working properly.

**DC breaker:** clean the contacts and it will extend the DC breaker lifetime.

**Waterproof plate:** check if the waterproof plate of device like RS485 is changed every year.

### 5.3.2 Daily maintenance

1. Before maintenance, please use a multimeter and other instruments to detect the voltage between the metal parts that need to be touched or may be touched and the grounding copper bar to avoid electric shock.
2. During maintenance, please pay attention to the warning labels of the inverter to prevent personal injury caused by high voltage.
3. During maintenance, please ensure that the DC input switch PV Switches are all disconnected.
4. After the maintenance is completed, follow the normal operation steps to start the machine.

String Inverter Maintenance Items and Cycle				
Check parts	Check item	Check items	Treatment question	Inspection cycle
overall inspection	exterior	Observe whether the appearance of the inverter is damaged or deformed?	In severe cases, please replace it in time	Every six months to one year
	system cleaning	Is there any foreign matter or dust on the surface of the inverter box?	Clean up foreign objects and dust	
		Whether the heat sink is blocked or dusty ?	Remove occlusion, clean up dust	
system running	operating status	Does the inverter make abnormal noises during operation?	In severe cases, please replace it in time	Every six months to one year
	operating parameters	When the inverter is running, check whether the parameters are set correctly?	Exclude abnormal settings	
connecting part	fall off, loose	Check whether the cable connection is disconnected or loose?	Tighten the connection according to the regulations	Half a year after the first commissioning, then once every six months to one year
	damage	Check whether the cable is damaged, and focus on checking whether the skin of the cable in contact with the metal surface has cut marks?	In severe cases, please replace it in time	
	terminal	Check whether the waterproof covers of unused ports such as RS485 and RJ45 are locked?	Guaranteed to be sealed	