

CONFIDENTIAL

SWAY BRACING IS REQ'D,
REFER TO MANUAL.
HANGER DETAIL SHOWN IS OUR STANDARD
DESIGN AND MAY NOT REPRESENT THE ACTUAL
HANGER DESIGN UTILIZED ON THIS SYSTEM.

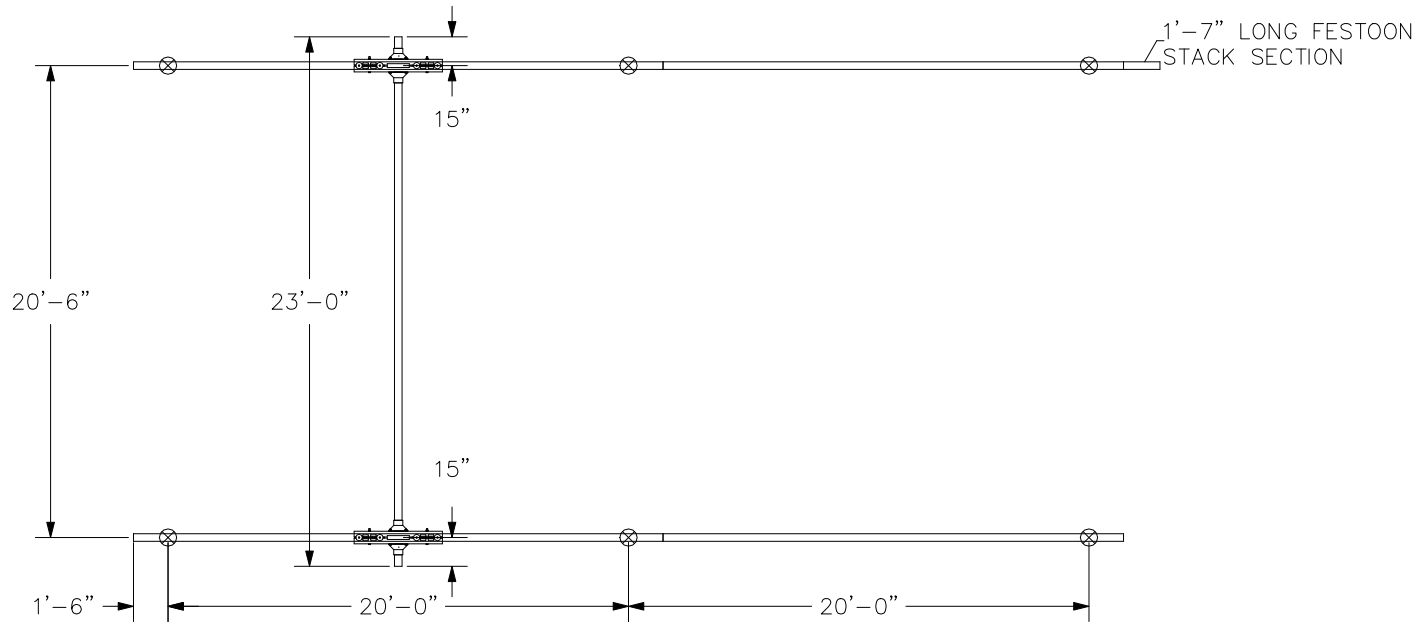

NOTE C: MINIMUM THD ROD DROP MUST MAINTAIN
3" OF CLEARANCE BETWEEN BRIDGE
AND LOWEST OBSTRUCTION.

BRIDGE TROLLEY TRAVEL IS 18'-6 1/16".
ENDTRUCK TRAVEL IS 38'-7 1/2".

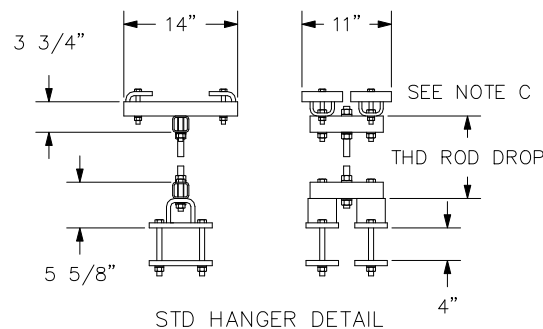
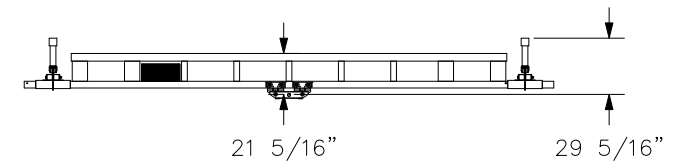
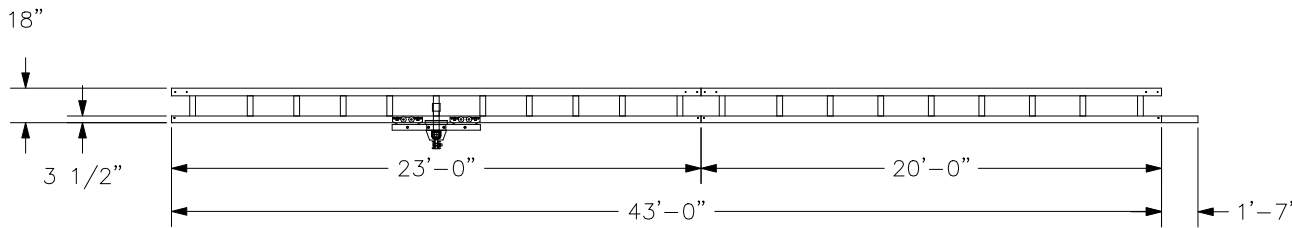

HANGERS ARE ON 20' CENTERS MAXIMUM
WITH A 48" CANTILEVER ON EACH END MAXIMUM.
HANGERS MUST BE WITHIN 48" OF SPLICE JOINT
⊗ = HANGER POINT
DO NOT SCALE FROM DRAWING.
DIMENSIONS ARE STEEL TO STEEL AND MAY VARY.
HANGER POSITION TOLERANCE = ±3 1/2"

CREATED BY: WISCOLIFT INC

CRANE INFORMATION		GORBEL 600 FISHERS RUN P.O. BOX 593 FISHERS, NY 14453-0593	
CAPACITY: 4000LBS/BR BRIDGE OAL: 23'-0" BRIDGE SERIES: 4000 RUNWAY OAL: 43'-0" RUNWAY SERIES: 4000			
TOLERANCE: ±1/8		GLCS4000-23-43	
QUANTITY: 1		GENERAL ARRANGEMENT	
I.D. #: DEMO4000C.4A		BY: bilcon	DATE: AUG 12, 2015
		LINE #: 4	P/N: DEMO4000C.4A