



Performance
IntelliSUPPLY

USER GUIDE

Microprocessor Controlled Multi-Stage 12V/14V/16V
Automatic Power Supply and Battery Charger
P/N PSC15 / PSC30 / PSC60

Sleek On-Board Design / Remote LCD Display
Three Mode Operation / XS Flex Output Leads / 120V & 230V AC Input

XS Power *Intelli*SUPPLY User Guide

About XS Power

XS Power designs and manufactures custom charging solutions for street rods, racing applications, and the mobile audio industry. These products include high performance batteries, chargers, and related accessories.

Trademarks

Trademarks, registered trademarks, and product names are the property of their respective owners and are used herein for identification purposes only.

Notice of Copyright

*Intelli*SUPPLY User Guide © January 2014 by XS Power. All rights reserved.

Disclaimer

UNLESS SPECIFICALLY AGREED TO IN WRITING, XS POWER:

(a) MAKES NO WARRANTY AS TO THE ACCURACY, SUFFICIENCY OR SUITABILITY OF ANY TECHNICAL OR OTHER INFORMATION PROVIDED IN ITS MANUALS OR OTHER DOCUMENTATION.

(b) ASSUMES NO RESPONSIBILITY OR LIABILITY FOR LOSS OR DAMAGE, WHETHER DIRECT, INDIRECT, CONSEQUENTIAL OR INCIDENTAL, WHICH MIGHT ARISE OUT OF THE USE OF SUCH INFORMATION. THE USE OF ANY SUCH INFORMATION WILL BE ENTIRELY AT THE USER'S RISK.

The following conventions are used in this guide.

▲ WARNING

Warnings identify conditions that could result in personal injury or loss of life.

▲ CAUTION

Cautions identify conditions or practices that could result in damage to the charger or battery.

***Important*:** These notes describe an important item that you must pay attention to.

Chapter 1, Introduction	p. 1-6
Quick Start Guide	
Chapter 1 contains information on safety guidelines, and the features, switches, and indicators on the front panel of the <i>Intelli</i> SUPPLY.	
Chapter 2, Operation	p. 7-11
Chapter 2 explains how to operate the <i>Intelli</i> SUPPLY correctly to charge a performance battery and use the power supply feature.	
Chapter 3, Troubleshooting	p. 12
Chapter 3 will help you identify and correct the common problems than can occur with the <i>Intelli</i> SUPPLY.	
Appendix A, Specifications	p. 13
Appendix A lists the specifications for the <i>Intelli</i> SUPPLY.	
Appendix B, Battery Charging	p. 14
Appendix B describes battery charging in more detail.	
FAQs.....	p. 15-16
Warranty	p. 17
Contact Information.....	p. 18

General Safety Precautions

▲ WARNING: Before installing and using the charger, read all instructions and cautionary markings on the charger, the batteries, and all appropriate sections of this guide.

- 1) Do not expose the *Intelli*SUPPLY to rain, snow, spray, or bilge water. To reduce risk of fire hazard, do not cover or obstruct the ventilation openings. Do not install the charger in a zero-clearance compartment. Overheating may result.
- 2) The *Intelli*SUPPLY is designed to be permanently connected to your AC and DC electrical systems.
- 3) The *Intelli*SUPPLY is designed to charge 12V, 14V and 16V lead-acid batteries of all types. Do not attempt to use with batteries of other voltages
- 4) Never use chargers at a location where there is danger of gas or dust explosions.
- 5) Use only attachments recommended or sold by the manufacturer. Doing otherwise may result in a risk of fire, electric shock, or injury to persons.
- 6) Do not disassemble the *Intelli*SUPPLY. Attempting to service the unit yourself may result in a risk of electrical shock or fire. Internal capacitors remain charged after all power is disconnected.
- 7) Do not open the *Intelli*SUPPLY. There are no user serviceable parts inside the unit. For service see the Returns policy in the back of this guide.
- 8) The charger must be provided with an equipment-grounding conductor connected to the AC input ground.
- 9) To reduce the risk of electrical shock, disconnect both AC and DC power from the charger before attempting any maintenance or cleaning or working on any circuits connected to the charger. Turning off controls will not reduce this risk.
- 10) Do not operate the charger if it has received a sharp blow, been dropped, or otherwise damaged in any way.
- 11) Be sure AC and DC cords are not pinched or otherwise damaged by hoods, doors, or other moving engine components.
- 12) Never attempt to charge a frozen battery.
- 13) **Fuse Holder:** Contains a 10A fuse in case of overload.
- 14) **AC Cord:** Grounded 3-pin 110V cord for use with grounded outlets only.
- 15) **Battery Clamps and Cord:** Allow for connection to the battery.

Features of the XS Power IntelliSUPPLY

The IntelliSUPPLY is an advanced power supply unit and battery charger designed specifically for high performance lead-acid batteries. This power supply/charger uses MOSFET rectifier technology with an advanced microprocessor control board to create a battery charger and power supply that can rapidly and safely recharge 12V, 14V and 16V flooded, maintenance free, deep cycle, gel-cell, and AGM (Absorbed Glass Mat) batteries in several sizes. The wireless remote and digital display makes the IntelliSUPPLY very easy to use.

Multi-Stage Charging

At the heart of the technology in the XS Power IntelliSUPPLY are the three distinct charging stages and DC power output. During the first stage, called "Bulk" charging, the charger will regulate the current the voltage is allowed to float. During this stage, 80% of the battery's capacity is restored.

When the battery's cell voltage comes up to the correct level, the second stage called "Absorption" charging is engaged. During this stage the voltage is fixed according to the battery type and voltage switches on the front panel and the current is allowed to float. The battery is brought to 100% during this stage and the cells are equalized.

The third stage is float charging. During this stage the voltage and current are reduced to a level that will maintain the battery indefinitely.

Several microprocessors are used to tightly control the entire process. This is the same technique that battery manufacturers recommend and use in the production of new batteries and it is the fastest and safest technique for battery charging.

Compatible With All Lead-Acid Type Batteries

Lead-acid batteries have different charging requirements based on their specific design. Flooded and maintenance free batteries require a higher voltage per cell than do sealed valve regulated types such as AGM and gel-cell batteries. Overcharging will reduce the life of any battery as sealed valve regulated batteries are especially sensitive to high charging voltages and overcharging. Some sealed valve regulated batteries are more sensitive to overcharging than others. If in doubt as to which battery setting to use for your application, contact the manufacturer of the battery being charged. Overcharging an AGM or gel-cell battery will cause permanent damage.

Power Supply Mode

Along with charging batteries, the XS Power PSC Chargers can operate as Power Supplies. When this mode is selected, the Charger will maintain a constant output voltage and current. Power Supply mode is to be used for audio display boards and can be used as test bench power supplies. Power Supply Mode should not be used to charge AGM Batteries.

Desulfation Mode

At the end of a battery's life, or in the event that a battery has sat uncharged for an elongated amount of time, it can become sulfated. This would reduce the capacity and performance of the battery. The PSC Chargers have the ability to recondition a battery that has sulfated. Through a complex charging cycle and microprocessor controlled pulsed output, the PSC charger can break down the sulfated crystals inside the battery which cause the lack in performance. Using this mode on older batteries once every few months is advisable to prolong battery life.

Remote Control/ Display

A remotely mounted display will show the status of the charging functions of the PSC models. This feature will allow the user to control power on/off. The remote will display important charger and battery information such as voltage, charge rate, mode, fault, and status of the battery being charged.

Voltage Monitoring

The battery's terminal voltage is measured every five minutes by the on-board microprocessors and this information is analyzed in addition to the elapsed time to dynamically control the Battery Charger for optimum charging performance.

Automatic Computer Analysis/Auto Shutdown

The microprocessors will analyze the battery when connected. If the battery's voltage is below 4V or the battery will not come up to the correct voltage in a ten-hour period the charger will automatically shut off.

UL Approved Battery Cables

Six feet of durable battery cables are provided that are resistant to cuts and abrasion. The copper plated battery clamps are compact and custom designed easy connections. All clamp connections are soldered for maximum current flow.

Internal Cooling Fan

A cooling fan automatically operates during charging to keep the transformer and other internal components at a constant safe temperature.

Front and Rear Panel Switches and Indicators

PSC15 / PSC30 Product Introduction

⚠ WARNING: Before installing and using the PSC unit, read all instructions and cautionary markings on the unit, the batteries, and all appropriate sections of this guide.

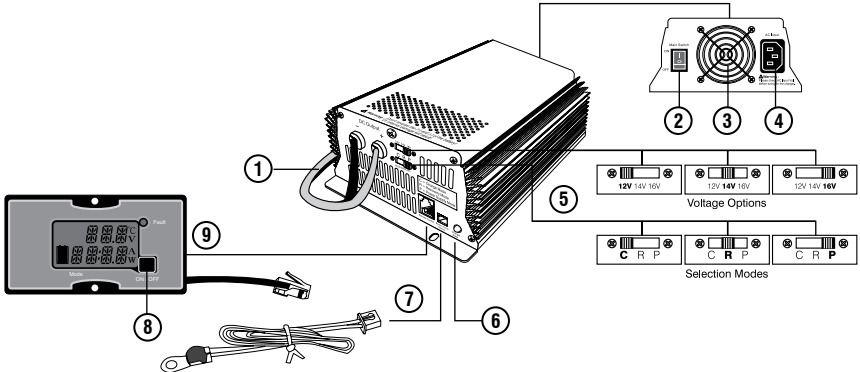

1- DC Output(+ Red / - Black) 2- Main On/Off Switch 3- Unit Cooling Fan 4- AC Input 5- Mode/Voltage Selection
6- Charging Status 7- Battery Temperature Sensor(note1) 8- Slave Switch(note2) 9- LCD Remote Control

PSC60 Product Introduction

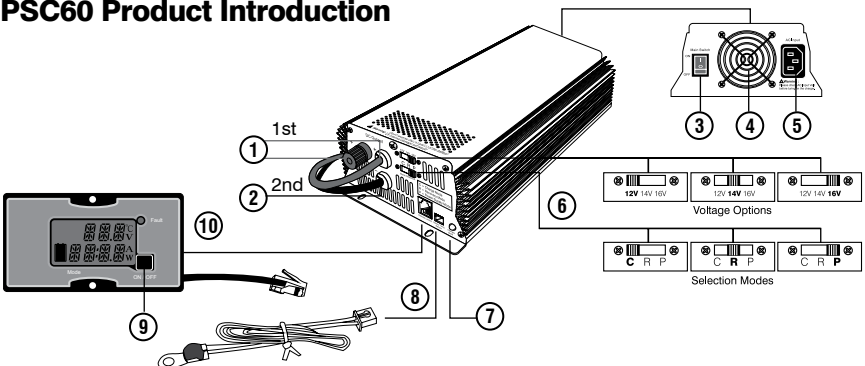

1- DC Output(+ Red-Primary[1st] / Secondary[2nd]) 2- DC Output(- Black) 3- Main On/Off Switch 4- Unit Cooling Fan 5- AC Input 6- Mode/Voltage Selection 7- Charging Status 8- Battery Temperature Sensor(note1)
9- Slave Switch(note2) 10- LCD Remote Control

⚠ WARNING: Don't reverse the (+) and (-) of the battery! Or internal damage will result!

Note 1: Battery Temp. Sensor: To detect the battery temp. while charging, please connect the wire sensor to the battery housing (the ring terminal should touch the battery housing) with adhesive or tape.

Note 2: The slave switch of the remote control just cuts out the output. If you want to turn off the charger completely, please switch off main switch of charger body.

Installation Diagram

⚠ IMPORTANT: Before charging, read the instructions. Disconnect the PSC unit before making or breaking the connections to the battery.

PSC15 / PSC30

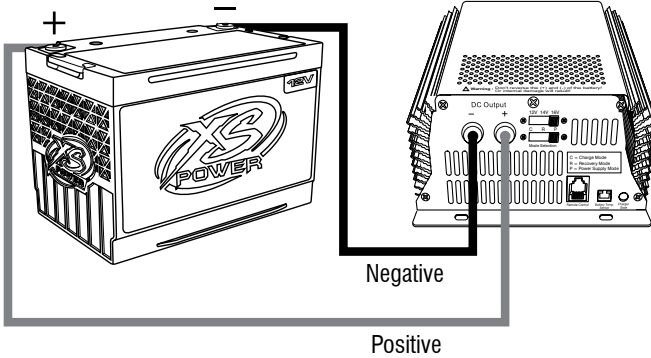

PSC60

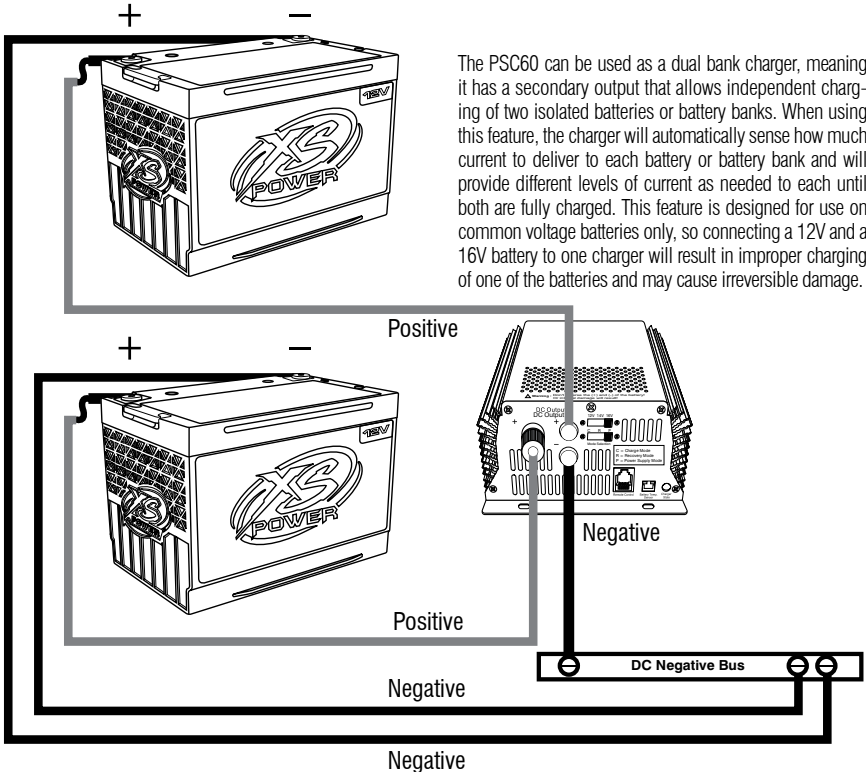

The PSC60 can be used as a dual bank charger, meaning it has a secondary output that allows independent charging of two isolated batteries or battery banks. When using this feature, the charger will automatically sense how much current to deliver to each battery or battery bank and will provide different levels of current as needed to each until both are fully charged. This feature is designed for use on common voltage batteries only, so connecting a 12V and a 16V battery to one charger will result in improper charging of one of the batteries and may cause irreversible damage.

Installation Location: Physical Requirements

Requirements For Installation

▲ IMPORTANT: This product is best mounted in a Horizontal position. If the unit is mounted in a vertical position the Cooling Fan Must Be at the bottom of the unit.

CONDITION	DESCRIPTION
Clean	Do not expose the charger to metal filings or any other form of conductive contamination. The presence of conductive contamination can cause damage and void your warranty.
Cool	For best performance, the ambient air temperature should be between 5°F (-15°C) and 113°F (45°C)- the cooler the better. At higher ambient temperatures, the output current will be automatically reduced to protect the charger from high internal temperatures.
Dry	The unit is intended for use in a dry location. Do not allow water or other fluids to drip or splash on the charger. Do not mount the charger in an area subject to rain, spray or splashing bilge water.
Safe	Working in the vicinity of lead-acid batteries is dangerous. Batteries generate explosive gases during normal operation. It is safest not to install electrical equipment in these areas.
Ventilated	Allow at least 4 inches (10 cm) of clearance around all sides of the charger for air flow. Ensure that the ventilation openings on the unit are not obstructed. If mounting in a compartment, ventilate the compartment with louvers or cut-outs to prevent overheating.
Close to AC Junction Box	Avoid the use of extended wire lengths if possible.
Close to Batteries	Avoid excessive cable lengths and use the recommended wire lengths and sizes. Undersized or overly long cables may affect charging accuracy.

LCD Display Mounting Bracket



FRONT VIEW

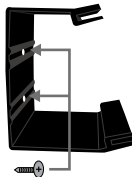

SIDE VIEW

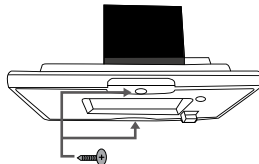

TOP VIEW

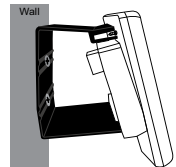

SIDE VIEW

LCD Remote Display

fault indicator

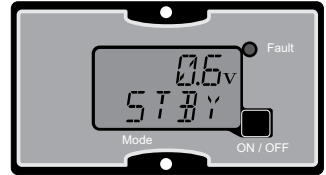
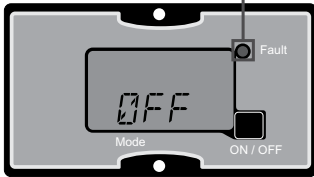

battery volt

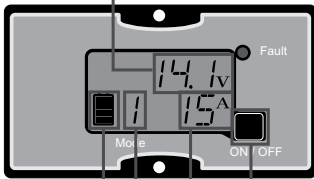

battery capacity
charging mode
ON/OFF switch
charging current

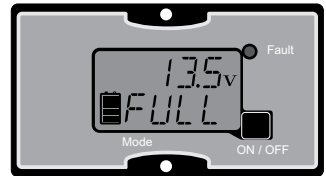

power supply DC output volt

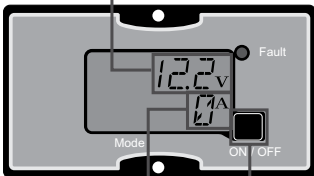

output current
ON/OFF switch

fault indicator (red lighting)

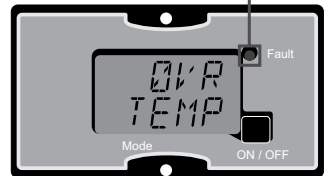

fault indicator (red lighting)

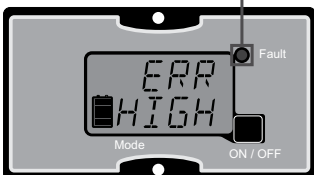

Charging Lead-Acid Batteries

⚠ WARNING: Before you start to charge batteries read the “Important Safety Instructions” on page (1) and take all safety precautions when working with batteries.

The IntelliSUPPLY has been designed to provide fully automatic recharge of 12V, 14V and 16V AGM and gel-cell batteries.

To charge your 12V, 14V or 16V battery:

- 1) If possible, disconnect all loads from the battery, by removing battery cables, opening a disconnect switch, or switching loads off.

⚠ CAUTION!

Although this is best, in a racing environment this may not be possible. Supplemental loads such as an electric water pump or cooling fans may be operated while charging during stage one. Please note though that supplemental loads will reduce the amount of amperage available to the battery. The charger detects that a battery is fully charged when its charging current drops below a preset limit in a specific elapsed time. The presence of electrical loads on the battery will interfere with this process. Therefore when the charger is in stage two-absorption charging it is necessary for the battery to be isolated from loads. The IntelliCHARGER is in stage-two when the charge rate is declining.

- 2) Select the correct battery voltage.
- 3) Connect the red positive (+) clip of the charger cables to the positive (+) terminal of the vehicle battery.
- 4) Connect the black negative (-) clip of the charger cables to a solid chassis ground. If this is not possible, connect it to the negative (-) battery terminal.
- 5) Flip the power switch on the front panel to ON.

The microprocessors will analyze the battery and then after a short delay, the charging status LED indicator will turn red beginning the three-stage charging sequence.

⚠ CAUTION: Do not change the voltage type during charging. Use the correct battery type at all times.

During stage one-bulk charging, the amperage will begin at 20A. During stage two-absorption charging, the amperage will start to fall to zero as the battery comes up to 100%. When the charging process is complete, the charging status LED indicator will turn green. The cooling fan inside the charger will stop and the battery can be left in this state indefinitely.

*Note that the charger will automatically restart the charging sequence if the charge current rises above a factory preset threshold.

- 6) When complete, flip the power switch to OFF.
- 7) Remove the black negative (-) clip and the red positive (+) clip from the vehicle's battery terminals.

PSC15 Specifications

MODEL		PSC15							
INPUT									
Voltage Range	120VAC (90~130VAC)								
Frequency Range	60Hz								
Efficiency	> =85%								
Power Factor	1.0 at full load (±5%)								
Input Socket	IEC plug								
OUTPUT									
Mode Selection	Charge Mode			Recovery Mode			Power Supply Mode		
Voltage Selection	12V	14V	16V	12V	14V	16V	12V	14V	16V
Bulk Stage	14.4V	16.8V	19.2V	/	/	/	14.4V	16.8V	19.2V
Absorption Stage	14.4V	16.8V	19.2V	14.4V	16.8V	19.2V	14.4V	16.8V	19.2V
Float Stage(2A Max)	13.56V	15.52V	18.08V	13.56V	15.52V	18.08V	13.56V	15.52V	18.08V
Max Current	15A								
Continuous Current	15A								
PROTECTION									
Over Temperature	131° ± 9°F / 55° ± 5°C								
Overload	YES								
Output Short Circuit	YES								
Microprocessor Check	YES								
ENVIRONMENT									
Working Temperature	5° ~ 113°F / -15° ~ 45°C								
Working Humidity	20 ~ 90% RH Non-Condensing								
Storage Temperature	-22° ~ 149°F / -30° ~ 65°C								
Storage Humidity	10 ~ 95% RH								
Temp Coefficient	±0.09%° (32° ~ 122°F) / ±0.05%° (0° ~ 50°C)								
FEATURES									
Remote Control	YES								
SIZE		SAE				METRIC			
Dimension (LxWxH)	8.4 x 5.6 x 2.85 in				213 x 142 x 72 mm				
Weight	4.2lbs				1.9kgs				

**The above spec. ±0.5V for 12V spec.; Amp. ±10% is acceptable.

△ Note: Specifications subject to change without notice.

PSC30 Specifications

MODEL		PSC30							
INPUT									
Voltage Range	120VAC (90~130VAC) / 230VAC (180~264VAC)								
Frequency Range	45 ~ 65Hz								
Efficiency	> =85%								
Power Factor	1.0 at full load (±5%)								
Input Socket	IEC plug								
OUTPUT									
Mode Selection	Charge Mode			Recovery Mode			Power Supply Mode		
Voltage Selection	12V	14V	16V	12V	14V	16V	12V	14V	16V
Bulk Stage	14.4V	16.8V	19.2V	/	/	/	14.4V	16.8V	19.2V
Absorption Stage	14.4V	16.8V	19.2V	14.4V	16.8V	19.2V	14.4V	16.8V	19.2V
Float Stage(2A Max)	13.56V	15.52V	18.08V	13.56V	15.52V	18.08V	13.56V	15.52V	18.08V
Max Current	30A								
Continuous Current	30A								
PROTECTION									
Over Temperature (F)	131° ± 9°F / 55° ± 5°C								
Overload	YES								
Output Short Circuit	YES								
Microprocessor Check	YES								
ENVIRONMENT									
Working Temperature	5° ~ 113°F / -15° ~ 45°C								
Working Humidity	21 ~ 90% RH Non-Condensing								
Storage Temperature	-22° ~ 149°F / -30° ~ 65°C								
Storage Humidity	10 ~ 95% RH								
Temp Coefficient	±0.09%° (32° ~ 122°F) / ±0.05%° (0° ~ 50°C)								
FEATURES									
Remote Control	YES								
SIZE		SAE				METRIC			
Dimension (LxWxH)	9.9 x 5.6 x 2.85 in				252 x 142 x 72 mm				
Weight	5.5lbs				2.5kgs				

**The above spec. ±0.5V for 12V spec.; Amp. ±10% is acceptable.

△ Note: Specifications subject to change without notice.

PSC60 Specifications

MODEL		PSC60							
INPUT									
Voltage Range	120VAC (90~130VAC) / 230VAC (180~264VAC)								
Frequency Range	45 ~ 65Hz								
Efficiency	> =85%								
Power Factor	1.0 at full load (±5%)								
Input Socket	IEC plug								
OUTPUT									
Mode Selection	Charge Mode			Recovery Mode			Power Supply Mode		
Voltage Selection	12V	14V	16V	12V	14V	16V	12V	14V	16V
Bulk Stage	14.4V	16.8V	19.2V	/	/	/	14.4V	16.8V	19.2V
Absorption Stage	14.4V	16.8V	19.2V	14.4V	16.8V	19.2V	14.4V	16.8V	19.2V
Float Stage(2A Max)	13.56V	15.52V	18.08V	13.56V	15.52V	18.08V	13.56V	15.52V	18.08V
Max Current	60A								
Continuous Current	60A								
PROTECTION									
Over Temperature	131° ± 9°F / 55° ± 5°C								
Overload	YES								
Output Short Circuit	YES								
Microprocessor Check	YES								
ENVIRONMENT									
Working Temperature	5° ~ 113°F / -15° ~ 45°C								
Working Humidity	22 ~ 90% RH Non-Condensing								
Storage Temperature	-22° ~ 149°F / -30° ~ 65°C								
Storage Humidity	10 ~ 95% RH								
Temp Coefficient	±0.09%° (32° ~ 122°F) / ±0.05%° (0° ~ 50°C)								
FEATURES									
Remote Control	YES								
SIZE		SAE				METRIC			
Dimension (LxWxH)	13.2 x 5.6 x 2.85 in				335 x 142 x 72 mm				
Weight	7.2lbs				3.5kgs				

**The above spec. ±0.5V for 12V spec.; Amp. ±10% is acceptable.

△ Note: Specifications subject to change without notice.

Precautions Working With Lead-Acid Batteries

Follow all instructions published by the battery manufacturer and the manufacturer of the equipment in which the battery is installed.

- 1) Make sure the area around the battery is well ventilated.



- 2) Never smoke or allow a spark or flame near the battery(ies).



- 3) Use caution to reduce the risk of dropping a metal tool on the battery. It could spark or short circuit the battery or other electrical parts and thereby cause an explosion.

- 4) Remove all metal items, like rings, bracelets, and watches when working with lead-acid batteries. Lead-acid batteries produce a short circuit current high enough to cause a severe burn.



- 5) Have plenty of fresh water and soap nearby in case battery acid contacts skin, clothing, or eyes.



- 6) Wear complete eye protection and clothing protection. Avoid touching eyes while working near batteries.



- 7) If battery acid contacts skin or clothing, wash immediately with soap and water. If acid enters your eye, immediately flood it with running cold water for at least twenty minutes and get medical attention immediately.

- 8) If you need to remove a battery, always remove the ground terminal from the battery first. Make sure all accessories are off to minimize the potential of a spark.

- 9) Someone should be in the range of your voice or close enough to come to your aid when working with a lead-acid battery.



- 10) Do not attempt to remove the vent covers on sealed lead-acid batteries such as the XS Power 16V AGM battery. Sealed batteries operate on a slight positive cell pressure. Venting this pressure will ruin the battery.

Chapter 3 will help you identify and remedy the common problems than can occur with the IntelliSUPPLY. Please read this chapter before calling Customer Service. If you cannot solve the problem with the IntelliSUPPLY, record the information asked for on “Information About Your System” on the back page and then call Customer Service.

⚠ WARNING: Electric shock hazard

Do not disassemble the IntelliSUPPLY. The IntelliSUPPLY does not contain any internal user-serviceable parts and attempting to service the unit yourself could result in electrical shock or burn.

• Power light does not come on when the power switch is flipped ON:

- Check fuse.
- Check cord and input power.

• Voltage LED will not illuminate for 12V, 14V or 16V:

- The battery is not connected.
- The battery is below 4.0V.

• Charge rate does not come up to the selected charge rate initially:

- The battery charger has already moved into stage two charging.
- Input voltage is below 120VAC.
- The battery may be defective and resisting the charge current.

• “Fault” indicator is illuminated:

- This illuminates when the battery cannot be completely charged in a 10 hour period at the selected charge rate

To reset this error, switch the battery charger OFF and remove the battery connections. Insure the battery polarity is correct. If you are charging a large battery at the 5A rate, try a higher charge rate. If the error persists, replace the battery.



Appendix A Specifications

Important: PSC15(15A), PSC30(30A), PSC60(60A) Output – Three amperage output models to choose from and isolated outputs for powering any size load. Specifications are subject to change without notice.

Physical Specifications

- Dimensions PSC15 - 8.4" L x 5.6" W x 2.8" H
PSC30 - 9.9" L x 5.6" W x 2.8" H
PSC60 - 13.2" L x 5.6" W x 2.8" H
- Weight PSC15 - 4.2 lbs (1.9 kg)
PSC30 - 5.5 lbs (2.5 kg)
PSC30 - 7.7 lbs (3.5 kg)
- AC Input Connections 5.0' (1.5 m) AWG 16
- DC Output Connections 6.0' (1.8 m) AWG 10

Electrical Specifications

- | | <u>12V</u> | <u>14V</u> | <u>16V</u> |
|----------------------------------|---------------|---------------|------------|
| - Absorption Voltage | 14.40 VDC ... | 16.80 VDC ... | 19.20 VDC |
| - Float Voltage at no Load | 13.56 VDC ... | 15.82 VDC ... | 18.08 VDC |
| - Maximum Output Voltage ... | 14.40 VDC ... | 16.80 VDC ... | 19.20 VDC |
| - Power Supply Voltage | 14.40 VDC ... | 16.80 VDC ... | 19.20 VDC |

AC Input Specifications

- AC Input VoltagePSC15 - 120VAC (100~130VAC)
PSC30 - 120VAC (100~130VAC) / 230VAC (180~240VAC)
PSC60 - 120VAC (100~130VAC) / 230VAC (180~240VAC)
- AC Input Current 10A RMS fuse protected

Appendix B

Battery Charging

Appendix B describes battery charging in more detail.

The *Intelli*SUPPLY charges batteries in a sequence known as multi-stage charging. The charging voltage delivered to the battery depends on the battery's depth of discharge.

The three automatic stages are:

- Stage One - Bulk
- Stage Two - Absorption/Equalization
- Stage Three - Float

Bulk Charge

In the first stage, known as “bulk” charging, the *Intelli*SUPPLY delivers its full-rated output current. This constant current is delivered to the batteries until the battery voltage approaches its absorption voltage, either 2.5V per cell or 2.375V per cell depending on battery type selected. The bulk charge stage restores about 75% of the battery's charge and this stage completes very quickly unless the battery is deeply discharged. During this stage the charge rate current on the ammeter should close to the charge rate selected on the front panel switch.

Absorption/Equalize Charge

During the second stage, known as “absorption” charging, the charging voltage is held constant near the gassing voltage, and the charging current is allowed to diminish as the battery comes up to 100% charge. Complex algorithms considering the time, voltage level, and charging current determine when the charger exits this mode and goes to stage three, float charging. The length of time of this mode depends on the battery and is not fixed.

Float Charge

The third stage, called “Float” charging is a maintenance mode in which the output voltage of the charger is reduced to a lower level, typically about 2.26 V per cell to maintain the battery's charge without losing electrolyte through gassing. In the float mode, the charger will initiate a new charge cycle if:

- AC power is disconnected and reconnected
- The current demand on the *Intelli*SUPPLY exceeds the battery recharge current setting.

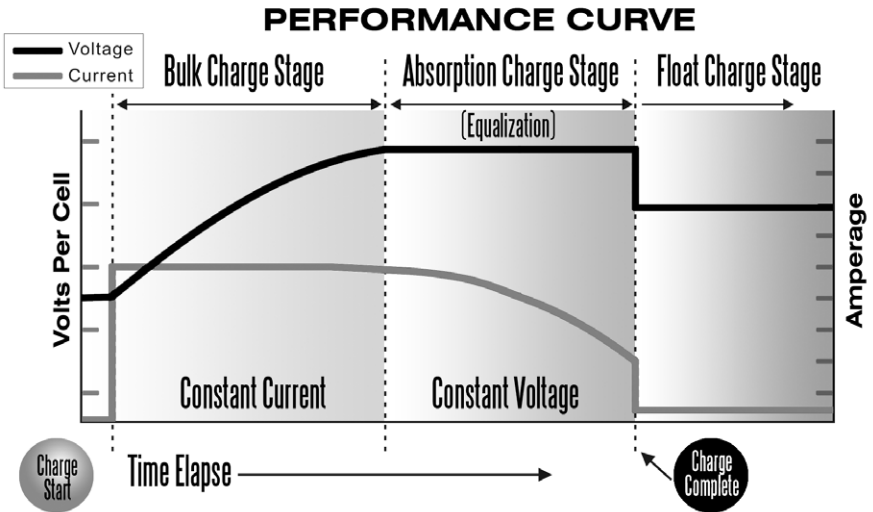

Figure B-1 Three-stage charging profile

FAQ's

Can I change the clamps on the charger with quick disconnects?

Yes. We recommend soldering all electrical connections where possible.

Can I run my electric water pump and cooling fan while charging?

Yes with a word of caution. There are two issues. First the charger will only provide 25A maximum charge current. Any amperage being consumed by extra electrical loads (ie. electric water pumps, etc.) will take away from the amperage available for battery charging. The battery charge time will be increased. In addition, the battery charger monitors the battery voltage and time to determine when the battery is at 100% charge. Extra electrical loads on the system will give the charger false information and therefore will prevent the charger from properly completing stage two.

Second, some electrical items can be damaged by high voltages. Data loggers, computers, and other items may lose data or be seriously damaged if subjected to the 19.0~20.0VDC of charging voltage. We do not recommend retrieving this information while charging. If in doubt about a particular component, consult with its manufacturer concerning its maximum input voltage.

⚠ CAUTION: Data loggers, computers of all sorts, and light bulbs may be damaged by the 19.0~20.0VDC of input voltage during charging. Do not operate these items while charging. We recommend disconnecting the battery from the system while charging.

Can I run this charger from a portable generator?

Yes with a word of caution. Since the output of the battery charger is directly proportional with the input voltage, we recommend portable generators with automatic voltage regulation. The *IntelliSUPPLY* is calibrated at the factory assuming 120VAC, 60Hz. Deviations from this voltage will cause deviations in the output voltage and overall performance.

How many batteries can I recharge at one time with the *IntelliSUPPLY*?

This depends on the size of the batteries. All batteries in the bank must be of the same type and size. In addition, the *IntelliSUPPLY* is expecting the battery bank to be at full charge in ten hours or less. Therefore the size of the batteries and their depth of discharge will play a role in the answer here. Given they were all XS Power 16V AGM batteries with a size of 45Ah at 100% discharged, you can charge up to four in parallel in ten hours.

Calculating External Battery Charging Time

Charging time will depend on the amp-hour capacity of your battery and on how deeply it is discharged. The following equation calculates an approximate charging time:

$$\text{Charging Time} = \frac{\text{CAP} \times \text{DOD}}{\text{CC} \times 80\%} \text{ where:}$$

Charging Time = Battery recharge time in hours
CAP = Battery capacity in amp-hours

DOD = Battery depth of discharge in percent.
A fully discharged battery has 100% DOD.

CC = Charge current. The rated current output of the charger in amps.

80% = Typical charging efficiency for lead-acid batteries.

Example:

An XS Power 16V AGM battery rated at 100 amp-hours is 40% discharged, that is, it has a DOD = 40%. Charging time with an *IntelliSUPPLY* 15A unit is calculated as follows:

$$\text{Charging time} = \frac{100\text{Ah} \times 40\%}{15\text{A} \times 80\%} = 1.35 \text{ hours (3.3 hours)}$$

Warranty

We take great pride in our quality, value and performance and believe that this product should offer you trouble free operation throughout its lifetime providing you take care to follow the simple instructions in the product documentation.

If you experience any problems with your product, please read the warranty details listed below carefully.

Limited Warranty

XS Power provides a one year warranty from the date of purchase, to the original purchaser. This warranty covers manufacturing defects in material and workmanship only.

XS Power does not cover damage or failure caused by abuse, misuse, faulty installation, improper maintenance, or any attempted repairs not carried out by XS Power.

There will be no obligations or liability on the part of XS Power for consequential damages arising from the use of the product or any indirect damages with respect to loss of property, revenue, or costs for removal, installation, or reinstallation.

For warranty service, the problem must be reported to XS Power to receive a unique RGA number (return goods authorization) and at that time you will be advised of where to send the faulty product.

All shipping charges for returns should be prepaid. If the requested repairs or service are within the terms of this warranty then the item will be returned to you on completion without any charge. The unit must be in its original packaging with any original accessories. XS Power will not be responsible or accept any liabilities for any loss or damage to additional items which are sent with returned product.

If the product is not covered under the terms of this warranty. XS Power will advise you of the costs to carry out any repairs necessary and the unit will be shipped to you on receipt of payment for the work including the return freight charges.

Please allow 2 to 4 weeks for return of your product. Under normal circumstance we try to ensure we carry out warranty repairs within 5 working days. We cannot be held responsible for delays in shipping.

Product

THIS LIMITED WARRANTY IS THE SOLE AND EXCLUSIVE WARRANTY PROVIDED BY XS POWER IN CONNECTION WITH YOUR XS POWER PRODUCT AND IS, WHERE PERMITTED BY LAW, IN LIEU OF ALL OTHER WARRANTIES, CONDITIONS, GUARANTEES, REPRESENTATIONS, OBLIGATIONS AND LIABILITIES, EXPRESS OR IMPLIED, STATUTORY OR OTHERWISE IN CONNECTION WITH THE PRODUCT, HOWEVER ARISING (WHETHER BY CONTRACT, NEGLIGENCE, PRINCIPLES OF MANUFACTURER'S LIABILITY, OPERATION OF LAW, CONDUCT, STATEMENT OR OTHERWISE), INCLUDING WITHOUT RESTRICTION ANY IMPLIED WARRANTY OR CONDITION OF QUALITY, MERCHANTABILITY OR FITNESS FOR A PARTICULAR PURPOSE. ANY IMPLIED WARRANTY OF MERCHANTABILITY OR FITNESS FOR A PARTICULAR PURPOSE TO THE EXTENT REQUIRED UNDER APPLICABLE LAW TO APPLY TO THE PRODUCT SHALL BE LIMITED IN DURATION TO THE PERIOD STIPULATED UNDER THIS LIMITED WARRANTY.

IN NO EVENT WILL XS POWER BE LIABLE FOR ANY SPECIAL, DIRECT, INDIRECT, INCIDENTAL OR CONSEQUENTIAL DAMAGES, LOSSES, COSTS OR EXPENSES HOWEVER ARISING WHETHER IN CONTRACT INCLUDING WITHOUT RESTRICTION ANY ECONOMIC LOSSES OF ANY KIND, ANY LOSS OR DAMAGE TO PROPERTY, ANY PERSONAL INJURY, ANY DAMAGE OR INJURY ARISING FROM OR AS A RESULT OF MISUSE OR ABUSE, OR THE INCORRECT OPERATION OF THE PRODUCT.

Exclusions

If this product is a consumer product, federal law does not allow an exclusion of implied warranties. To the extent you are entitled to implied warranties under federal law, to the extent permitted by applicable law they are limited to the duration of this Limited Warranty. Some states and provinces do not allow limitations or exclusions on implied warranties or on the duration of an implied warranty or on the limitation or exclusion of incidental or consequential damages, so the above limitation(s) or exclusion(s) may not apply to you. This Limited Warranty gives you specific legal rights. You may have other rights which may vary from state to state or province to province.

Information About Your System

Tell Us About Your System

As soon as you unpack your XS Power IntelliSUPPLY, record the following information and be sure to keep your proof of purchase.

Serial Number (on back panel) _____

Purchased From _____

Purchase Date _____

If you need to contact Customer Service, please record the following details before calling. This information will help our representatives give you better service.

Battery type, brand, and voltage: _____

Is this used with a portable generator? _____

Description of the problem: _____

Contact Information

XS Power

2847 John Deere Dr. Suite 102
Knoxville, TN 37917

Ph: 888.497.7693 (toll free North America)

Ph: 865.688.5953

Fax: 865.281.9844

info@xspowerbatteries.com

www.xspowerbatteries.com



REAL POWER
UNREAL PERFORMANCE™

865.688.5953

• XSPowerBatteries.com