



Onyx

Compact, eye-catching, contactless payment and telemetry device

Onyx Installation Guide

© Property of Nayax

All rights reserved

For more information contact us at support@nayax.com

Table of Contents

| | |
|-----------------------------------|----|
| General Information..... | 3 |
| Organization of the Manual | 3 |
| Device Overview..... | 4 |
| Device Cables..... | 4 |
| Device Components | 5 |
| Parts Included in the Box..... | 6 |
| Optional Accessories | 7 |
| Installation Process | 8 |
| System Requirements | 8 |
| Installation..... | 8 |
| Operating and Testing..... | 10 |
| Appendix 1- Insert SIM Card | 11 |

General Information

This section explains the classification of the manual and the purpose for which it is intended.

Organization of the Manual

The installation guide consists of four sections namely General Information, Device Overview, and Installation Process.

General Information section explains the purpose for which the manual is intended.

Device Overview section provides an overview of the device. The summary outlines the device configuration, additional accessories and the various cable configuration used for different machines.

Installation Process provides instructions as for how to manually install/dismantle the device, inserting the SIM card separately and performing final tests before using the device.





Lastly, Appendix 1 – Insert SIM Card provides a detailed description of the SIM Card installation process, if required.

Device Overview

This chapter provides an overview of the device components along with the additional accessories.

Device Cables

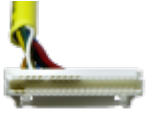
Nayax provides different configuration cables to suit different machines. The below table refers to each cable and its configuration.

| Image | Connector | Connects to |
|---|-------------------------|-------------------------|
|  | MDB | MDB at vending machines |
|  | DEX | DEX |
|  | RS232 DB9 Female Output | Serial |
|  | Device 40-pin | Nayax Onyx |
|  | LAN | LAN cable |

Device Components

Front Panel

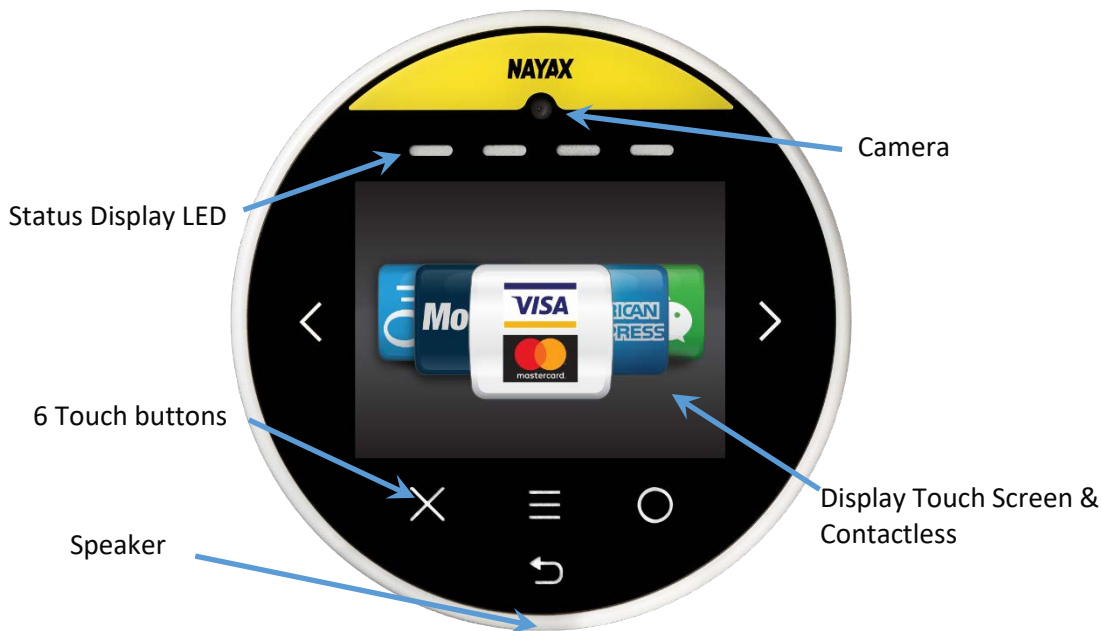

Front Panel Color - Yellow / Black

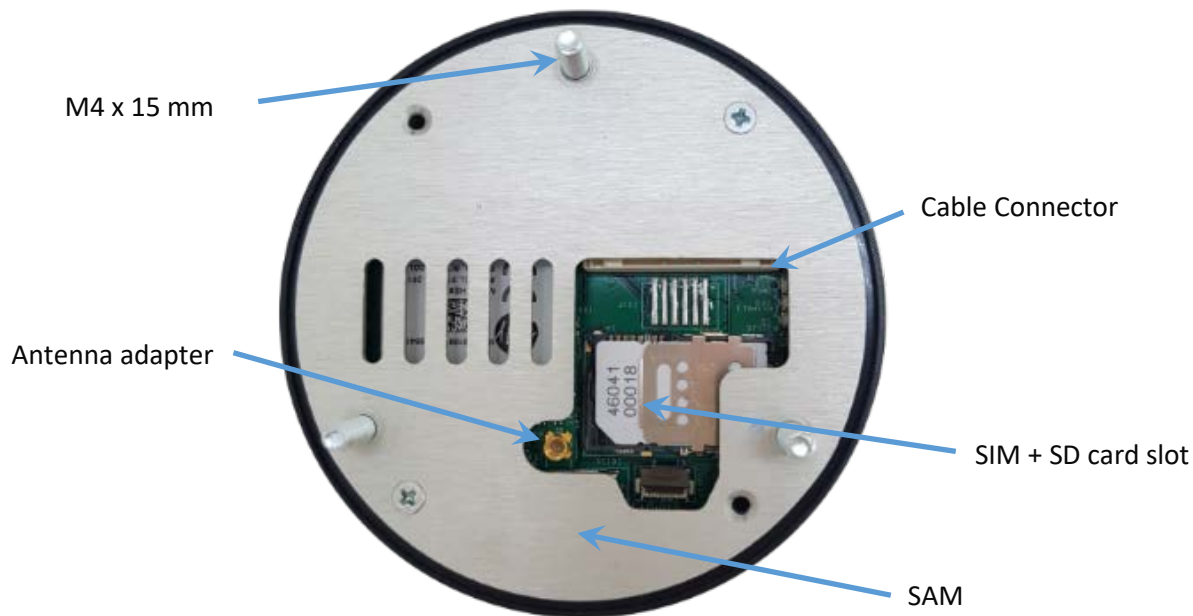

Rear Side

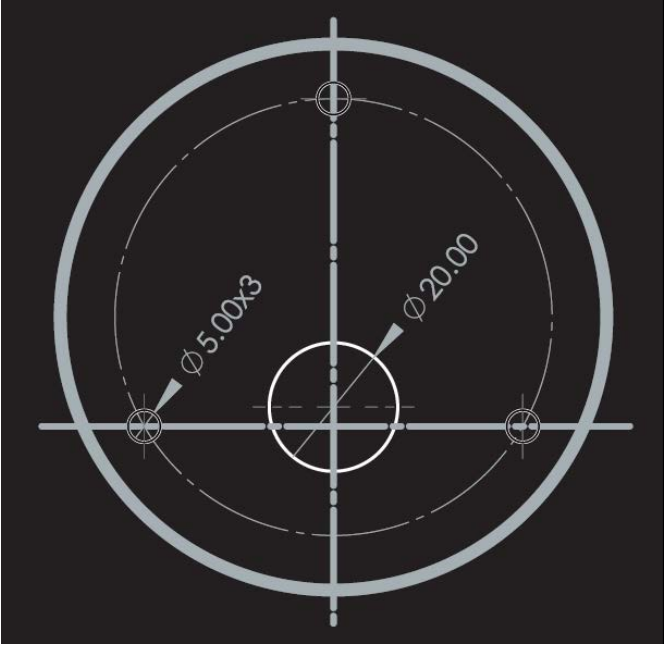

Parts Included in the Box

| | |
|------------------|--|
| Stencil |  |
| Soft cloth |  |
| External Antenna |  |

Optional Accessories

Mounting Bracket (Internal Installation)

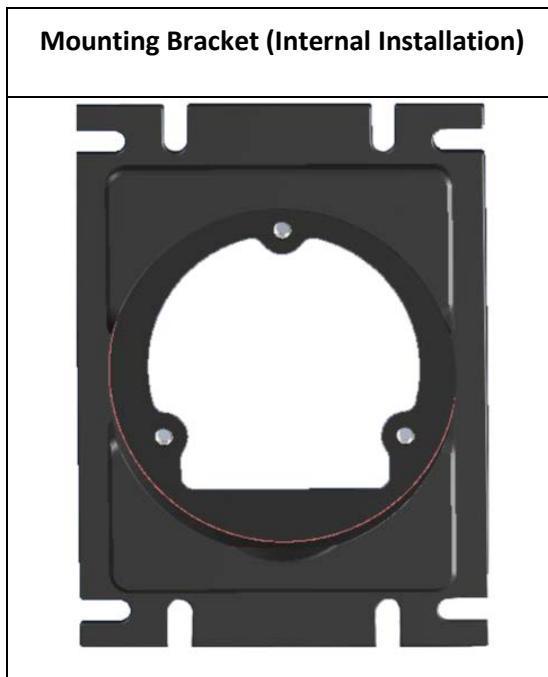

External Case

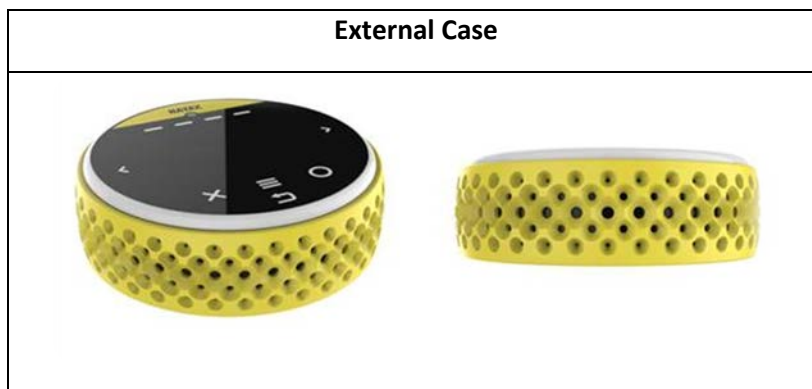

**Note: On purchase of external case, the Nayax device is not included.*

Installation Process

This comprehensive installation guide refers to the latest device version. It is important to read the guide before proceeding with the installation process.

System Requirements

Prior to installation, the NayaxVend Management System needs to be updated from the backend. Keep in mind upon purchase, the device is preconfigured to a machine with the standard parameters by Nayax support.

It is recommended that the machine is loaded with products and that the prices are updated in the system before testing the device.

Installation

Step 1. Install Nayax Onyx to the machine

Option A : External Installation

- Unscrew the 3 nuts from the rear end of the device.
- Select a location on the external door for installing the device.



Ensure that the door switch does not interfere with the working of the machine

- Use the stencil to mark and then drill 3 holes (5mm each). An additional hole of minimum 20 mm ($\frac{13}{16}$ inch) is required for passing the cable and antenna.

Option B: Internal Installation (in case additional accessories is purchased)

- Unscrew the 3 nuts from the rear end of the device.
- Attach the device to the Internal mounting bracket using the 3 device nuts. Fasten the nuts to secure the device into the bracket.
- Dismantle the window cover from the machine. Keep the machine's 4 screws.

Pro Tip

For a pulse machine installation, refer to the Nayax Pulse Manual.

Step 2. Connect Onyx cables

- Connect 40-pin connector plug to the device
- In case a coin mechanism is connected to the machine:
 - i. Disconnect the coin mechanism connector from the machine
 - ii. Connect coin mechanism connector to the Onyx cable
- Connect MDB/JVMA/Fuji connector to the machine's connector

Step 3. Connect the external antenna

Step 4. Secure the device

Attach the bracket and the device with the help of 4 screws



Pro Tip: You may need a swiss spanner wrench / Philips screwdriver for dismantling purposes.

Operating and Testing

1. Turn on the machine.
2. Once the Onyx is powered-up, a Self-Test is automatically initiated that performs a SIM card and Server Connectivity check.

i *Note: If the device is not installed correctly, you may see an error message on the screen.*

3. Once the Onyx is fully initialized, carry out the following trial purchases:
 - a. Cash /Credit purchase
 - b. E-money (E.g. A prepaid card) transaction
 - c. Canceled transaction to confirm that credit is not retained

Once all trial purchases are successfully completed, the unit is fully installed and ready for use!

Pro Tip

Make sure not to damage the cable/antenna wires.

Appendix 1- Insert SIM Card

The SIM Card is installed and included in the device. However, for any reason, if you need to insert a new SIM then follow the steps below.

Step 1: Lift the SIM card slot by pulling the cradle towards you and insert the SIM card in the slot



Step 2: Lock SIM card in place by pushing the cradle down onto the main board. Slip the silver clutch up to lock the card in place.



i **Note: Make sure that the SIM is inserted in the right direction as shown in the image above.**