

EN

up+tec®



Pedestal system
for raised floors

 **profil+tec**
positive profile

up+tec[®]



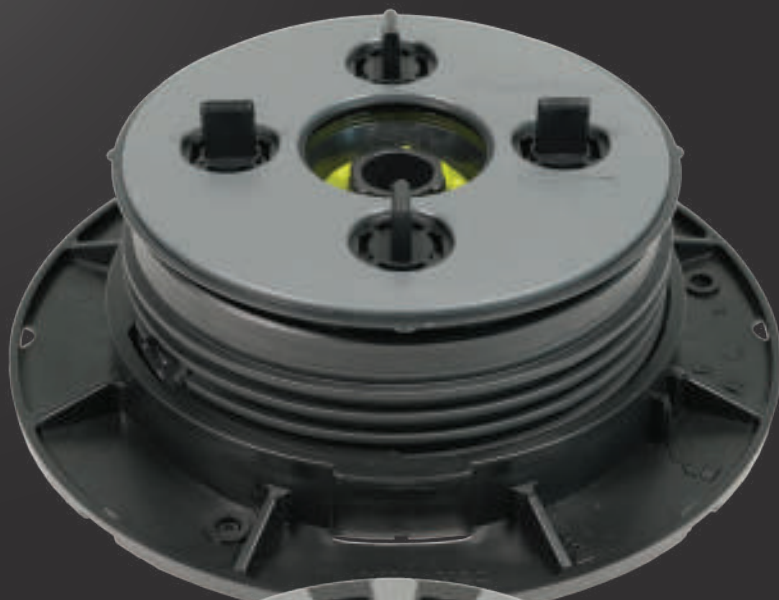

up+tec®

Pedestals for raised floors with integrated system for switching from self-levelling to fixed head.



Patented system



up+tec® FX

Fixed head pedestals for raised floors.



Patented system

RAISED FLOORS

The installation of raised floors offers benefits that go beyond a simple aesthetic function. They are ideal for hiding pipes and electrical systems, promote rain water outflow, reduce footstep noise, and the ease of inspection makes the system versatile and safe. Profillitec's uptec system is the best solution for outdoor raised floors such as terraces, gardens, pool sides, verandas and public places while offering very high load resistance.

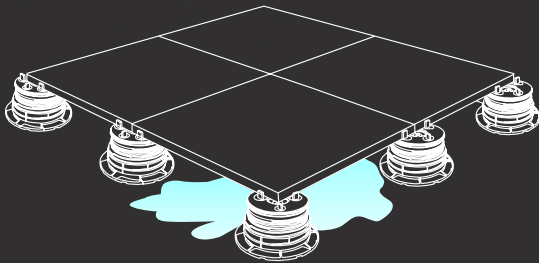

Rapid water outflow

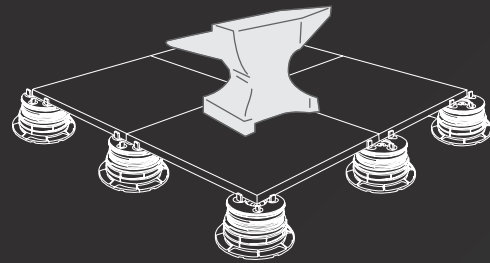

High load resistance

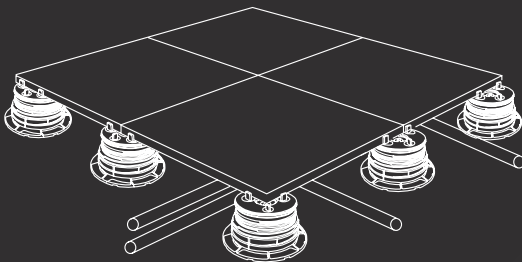

Ideal for hiding pipes and installation cables

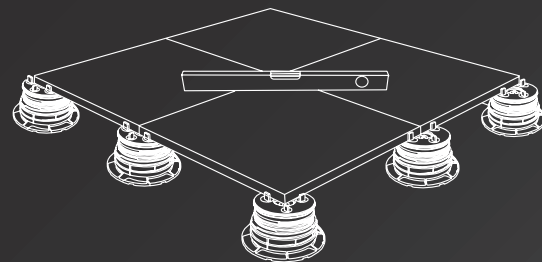

Level and easy to inspect floor



Applications

Terraces
Poolsides
Roof decks
Walkways

Gazebo
Hot tubs
Gardens
Bars and restaurants

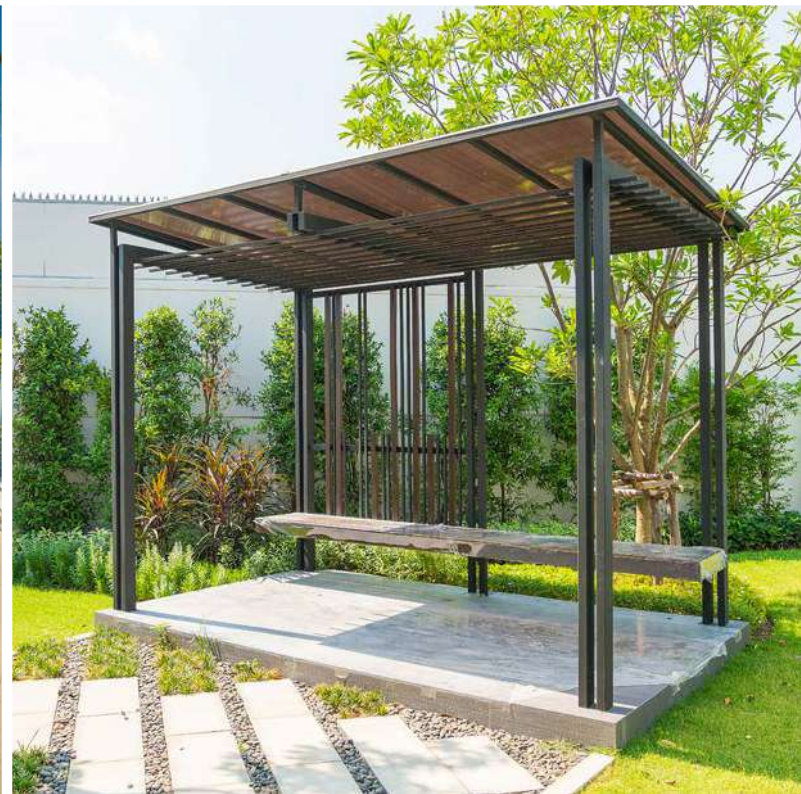

SELF-LEVELLING AND FIXED HEAD PEDESTALS

uptec

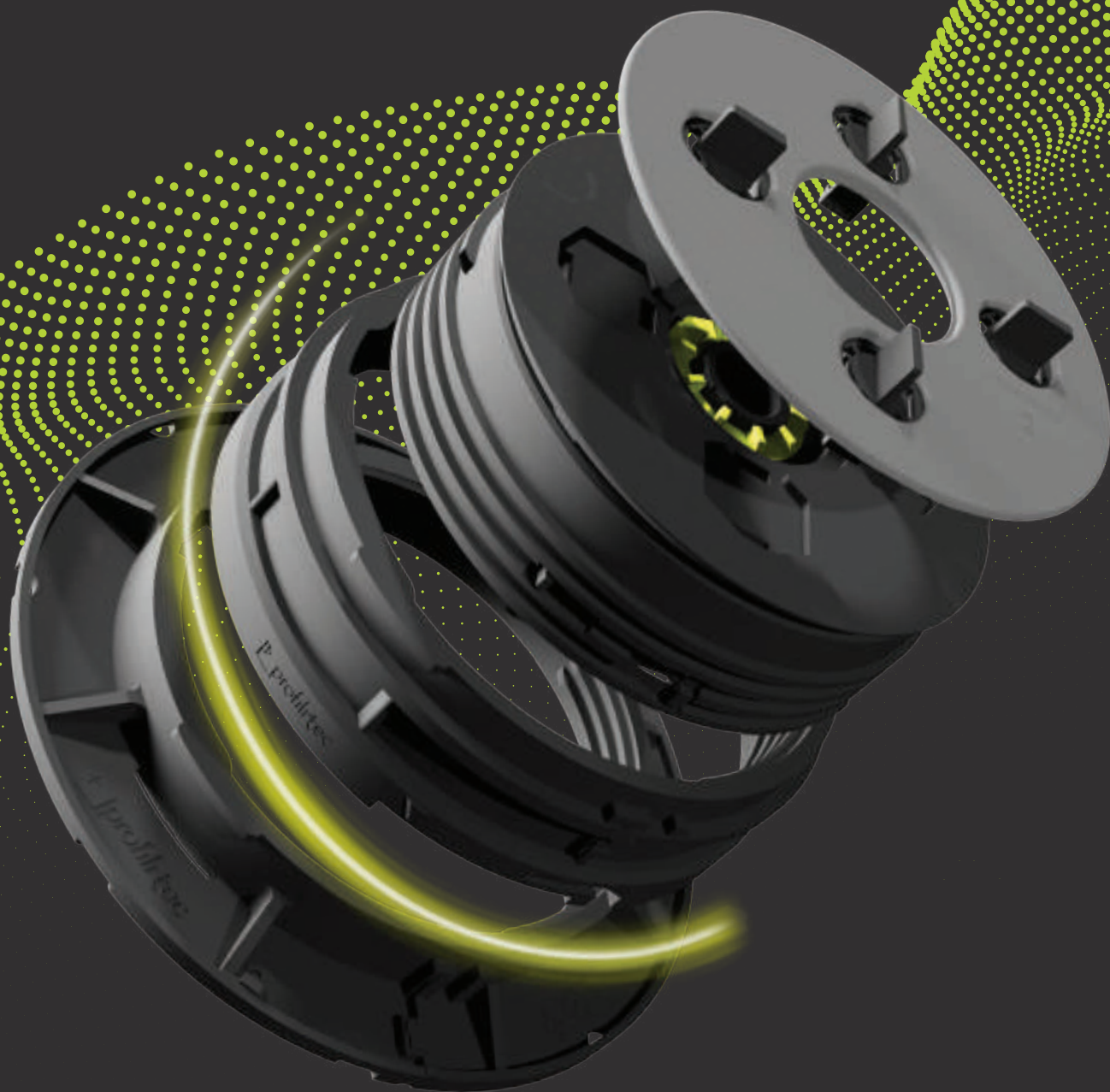



uptec® 

Uptec is a system consisting of self-leveling and fixed head supports adjustable in height for the realization of raised floors. Uptec is based on the **3-in-1** concept, three products (3 base items) that offer a unique logistical advantage and can achieve any height and compensate up to 5% slope with the combination of only 3 components.

uptec[®]

uptec



SUPAL

Low pedestal



SUPAS

Standard pedestal



SUPAR

Extension ring

combinable with

SUPA2

SUPA4

SUPAW



Head with 5/64"
(2 mm) tabs



Head with 5/32"
(4 mm) tabs

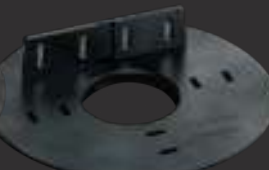

Head to be fixed on
wooden joists

COMPOSITION

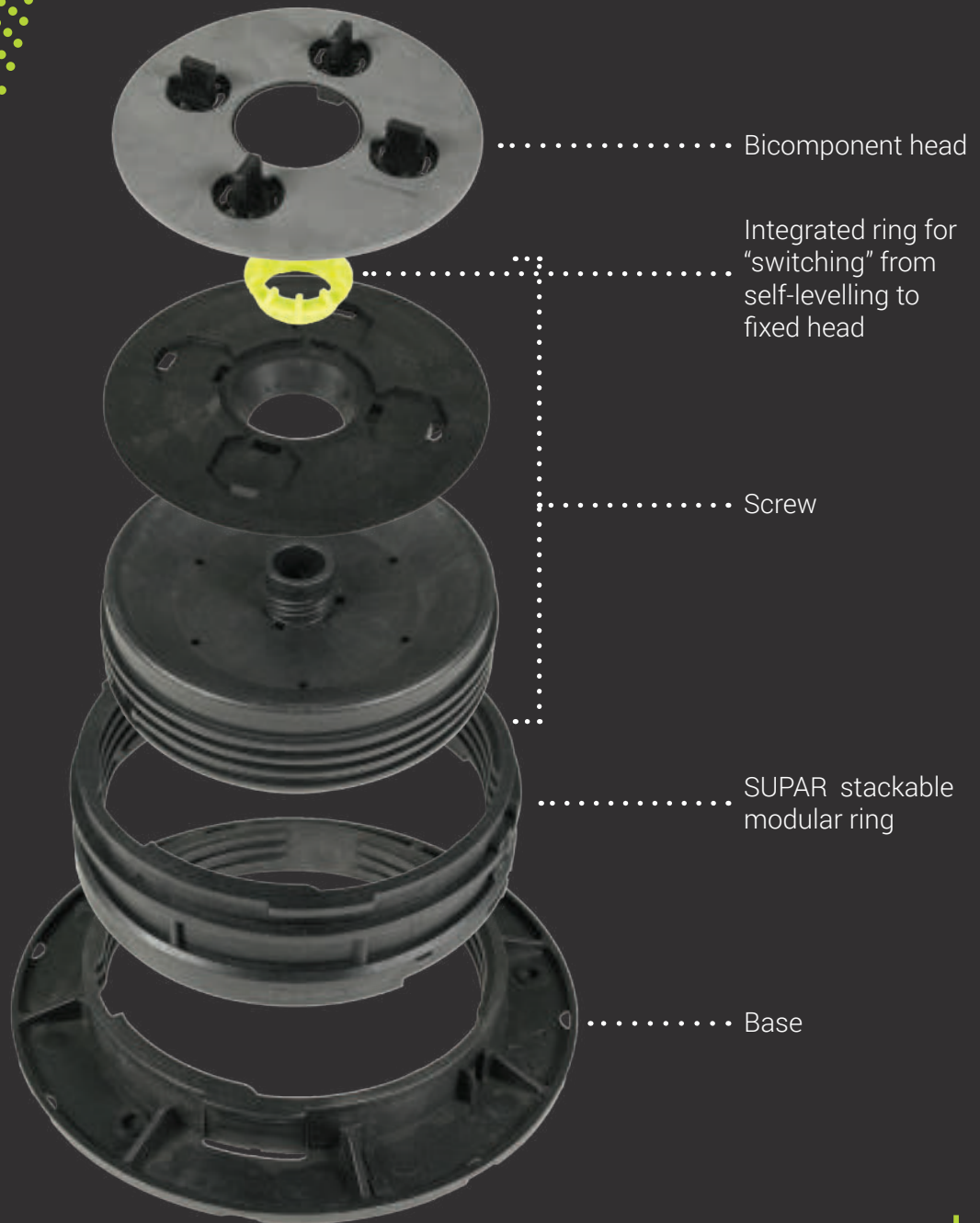

HEIGHT PROGRESSION

The combination of the three elements, along with the special self-levelling or fixed head, offers the possibility to achieve notable installation heights even when the underlying surface is sloped (up to 5%). An advantage that allows an extraordinary versatility even during installation.

uptec



Stackable modular rings designed to achieve **any installation height** (from 2 9/32" - 58 mm).



1 SUPAR
+ 1 3/16"
(+ 30 mm)

uptec

uptec®

SELF-LEVELLING AND FIXED HEAD

The uptec system offers an innovative solution in which the switch from a self-levelling to a fixed head system is made quickly and accurately by adjusting a specially designed ring nut, which is already assembled.

uptec

SELF-LEVELLING



5% SLOPE



FIXED



0% SLOPE

SUPAK MULTIFUNCTION KEY

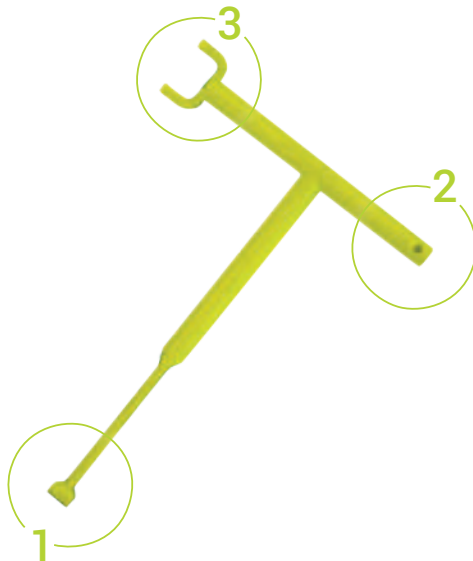

1 Height adjustment

2 Tab removal

3 From self-levelling to fixed head



FEATURES AND FUNCTIONS

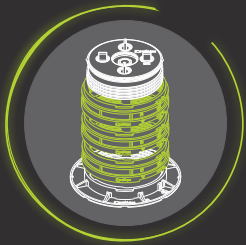

Modular height

Add SUPAR ring to increase the height of the pedestal

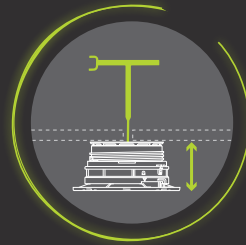

Adjustable height

Height of the pedestal can be adjusted from the top even when the floor is laid



Self-levelling and fixed head

Simple integrated switching mechanism from self-levelling head to fixed head

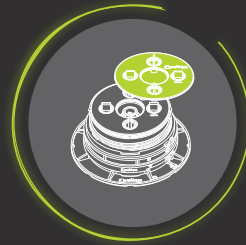

Interchangeable heads

Interchangeable heads for standard, wood or aluminum joist installations



Anti-slip and anti-noise

Heads equipped with anti-slip and anti-noise rubber to reduce noise from footsteps and impacts

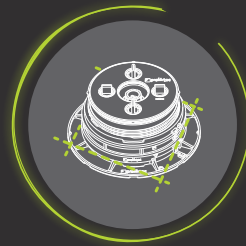

Pre-cut base

Cut marks on the base to facilitate placement on corners and perimeters



Low environmental impact

Made completely from recycled and recyclable material



Load resistance

Resistance to loads up to 3086 lb (1400 kg)

FIXED HEAD PEDESTALS

uptec FX

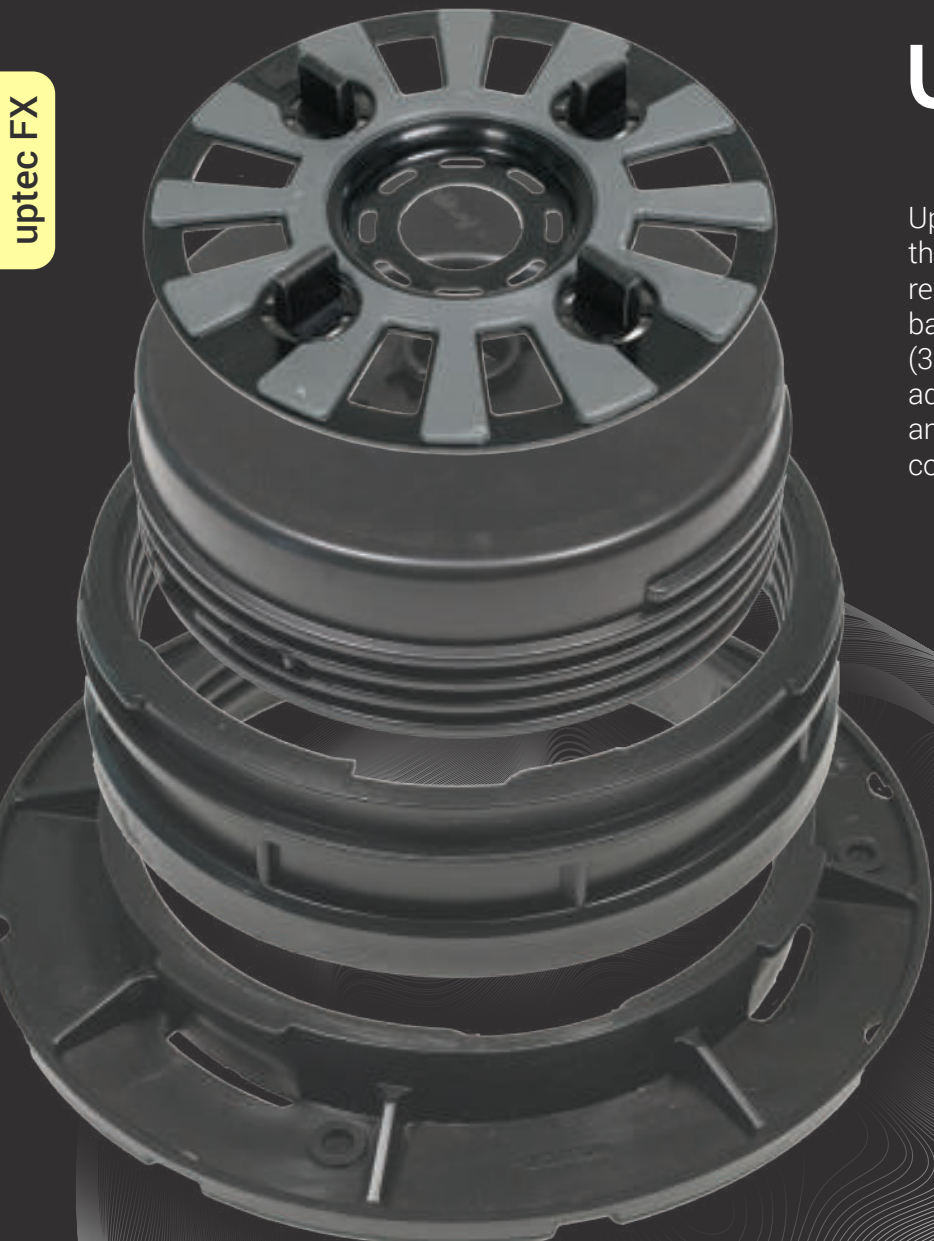

uptec[®] FX

Uptec FX is a system of fixed head supports that can be adjusted in height for the realization of raised floors. Uptec FX is also based on the **3-in-1** concept, three products (3 base items) that offer a unique logistical advantage and make it possible to achieve any height with the combination of only 3 components.

The ideal solution in terms of ease of use in the case of large, horizontal and planar surfaces.



FX



uptec FX

uptec[®] FX

SUPALFX

Low pedestal

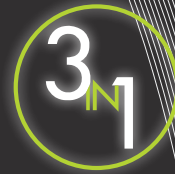

SUPASFX

Standard pedestal

SUPAR

Extension ring

..... combinable with

SUPA2FX

SUPA4FX



Head with 5/64"
(2 mm) tabs



Head with 5/32"
(4 mm) tabs

uptec FX

COMPOSITION

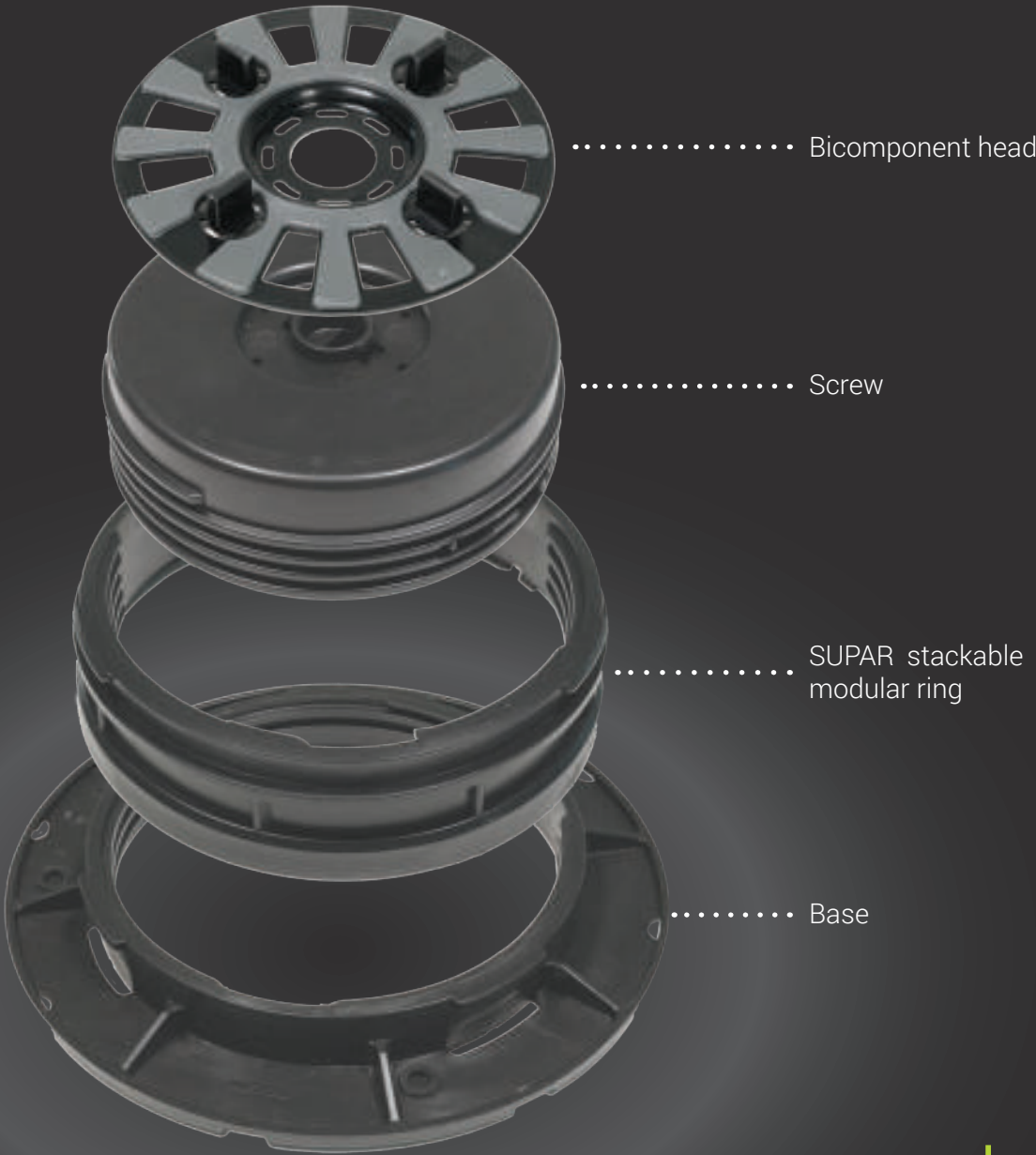

uptec FX

HEIGHT PROGRESSION

The combination of the 3 components makes it possible to achieve any installation heights. An advantage that offers extraordinary versatility during ongoing installation.

uptec FX



SUPAK MULTIFUNCTION KEY

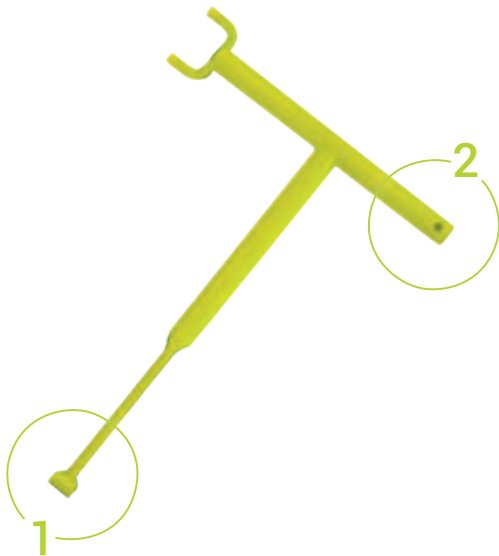

1 Height adjustment

2 Tab removal



FEATURES AND FUNCTIONS



Modular height

Add SUPAR ring to increase the height of the pedestal



Adjustable height

Height of the pedestal can be adjusted from the top even when the floor is laid

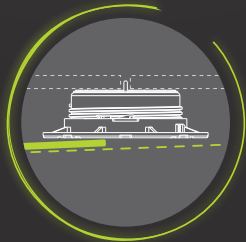

Slope compensation

Dedicated accessory for slope correction when needed

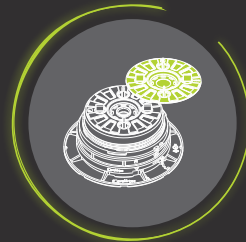

Interchangeable heads

Interchangeable heads for standard or aluminum joist installations



Anti-slip and anti-noise

Heads equipped with anti-slip and anti-noise rubber to reduce noise from footsteps and impacts

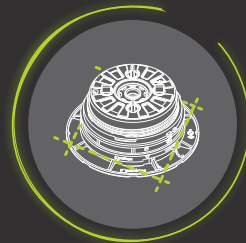

Pre-cut base

Cut marks on the base to facilitate placement on corners and perimeters



Low environmental impact

Made completely from recycled and recyclable material



Load resistance

Resistance to loads up to 3086 lb (1400 kg)



Uptec ground is a support system for the creation of raised floors featuring reduced height, for outdoor use. Two adjustable support models from 3/8" - 10 to 9/16" - 15 mm, SUPT (for 5/64" - 2 mm joints) or SUPT4 (for 5/32" - 4 mm joints). Height can be increased by 5 mm using the stackable accessory SUPB (up to a maximum of 3). The system is manually adjustable and does not require the use of an adjustment key.

uptec ground



SUPT/ SUPT4

Adjustable pedestal
from 3/8" to 9/16"
(from 10 mm to 15 mm)



SUPB

Extension + 3/16" (+5 mm)

HEIGHT PROGRESSION

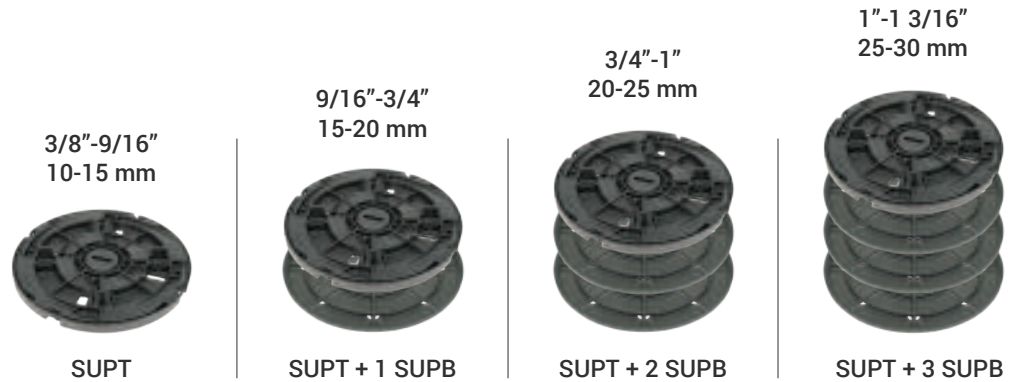

uptec ground

FEATURES AND FUNCTIONS



Height can be adjusted by 1/32" (0.5 mm) at the time



Desired height is clearly visible in inches and mm



Made completely from recycled and recyclable material

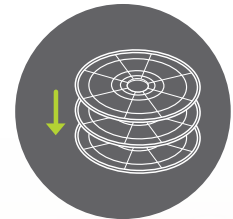

Stackable extension to obtain greater heights

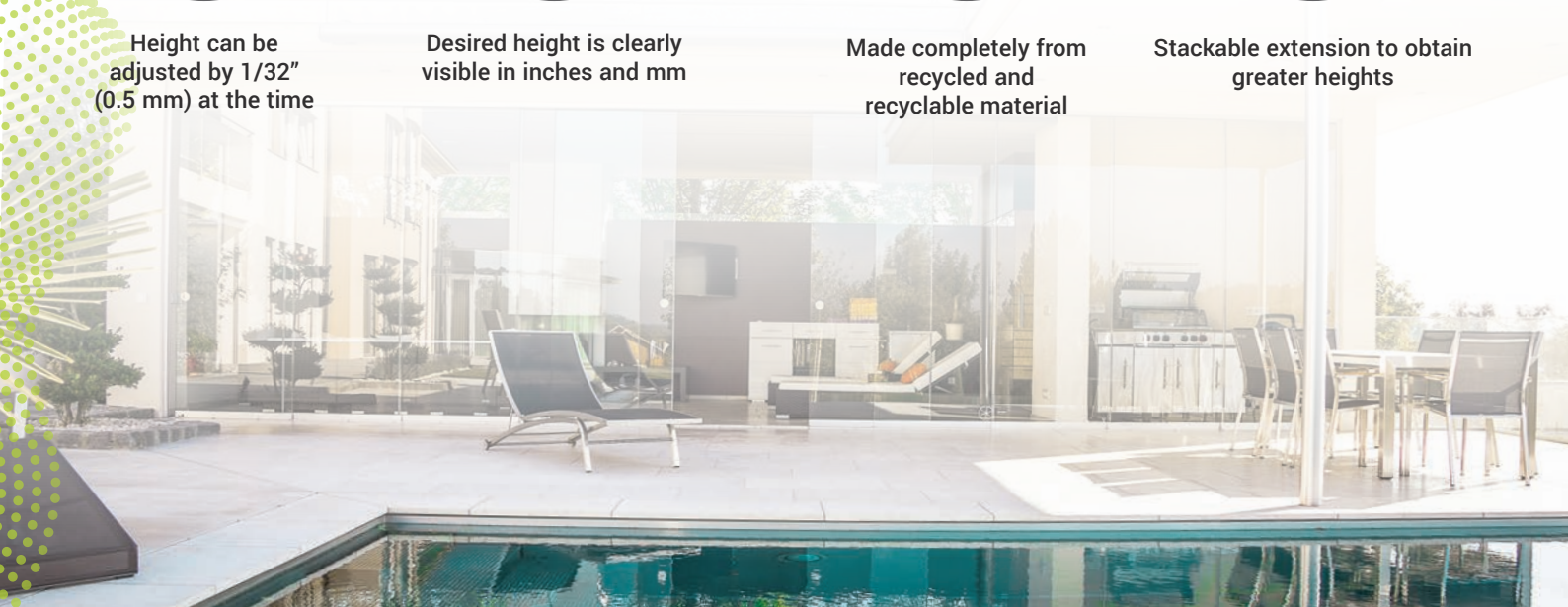

THE MODULARITY OF UPTEC AND UPTEC FX

ADVANTAGES AT THE CONSTRUCTION SITE



Minimized returns

Any leftover items are easily used in future installations.

Installation delay risk reduced

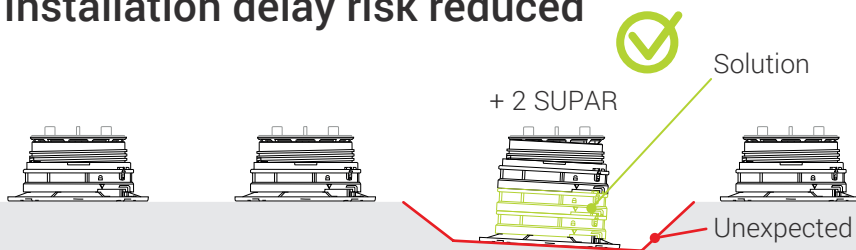

Unexpected obstacles due to ground configuration can be quickly resolved.
Back-and-forth between construction site and warehouse are avoided in case of unexpected complications.



ADVANTAGES IN WAREHOUSE



Optimized stock management

Minimal number of SKUs permits:

- Extremely simplified management of the entire supply chain.
- Minimized returns from the construction site.

Profilitec



Other solutions



Minimum stocked volume and value



Profilitec



Other solutions

PRODUCT ENGINEERING

Profilltec applies state of the art engineering calculation methods to ensure the highest quality and performance standards.

FEM (Finite Element Method) is a numerical technique that is used in load bearing analysis to evaluate the behavior of a product or structure under stress.

Applying the expected loads, the FEM calculates the stresses, deformations, and structural reaction. The results obtained provide an assessment of the stability and thus the safety of the structure, enabling optimization of the design and prevention of possible failure or collapse.

Degree of load distribution



Thanks to the FEM calculation, simulating loads applied to the uptec head, it is noticeable that the load stress on the screw thread develops vertically on the support. This **stress is concentrated only in the circumference** and is not distributed on the base. This means that due to the larger diameter, uptec has an ideal load distribution ensuring **high weight resistance**.

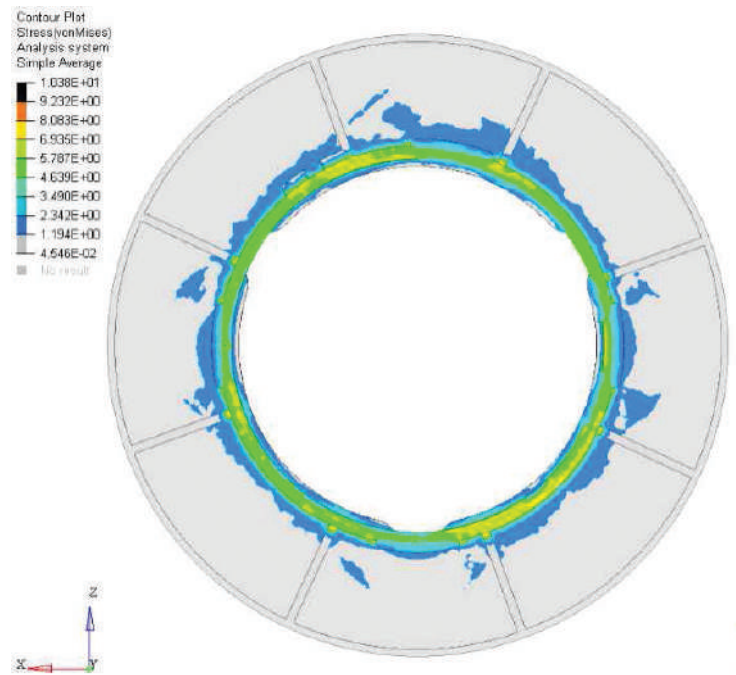
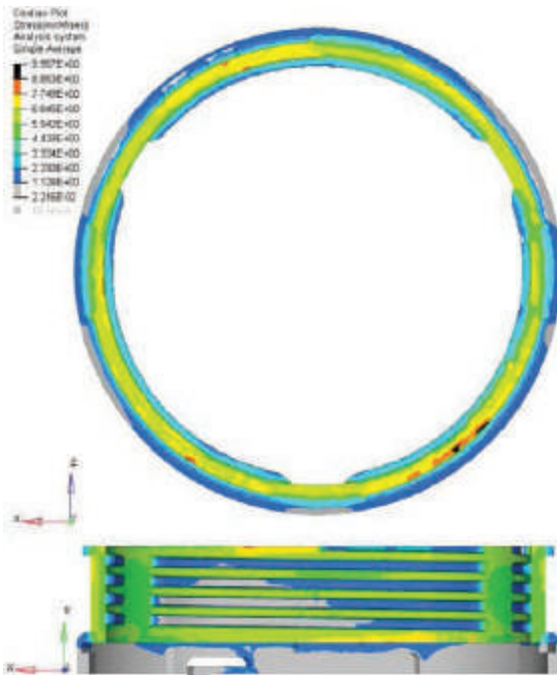

RECORD-BREAKING STRENGTH, STABILITY AND SAFETY

Uptec has an exceptional load resistance of 3086 lb - 1400 kg. Moreover, thanks to the large head surface and the large diameter of the fifth wheel, it offers greater stability to the tile when it is placed and perfect load distribution. These features guarantee outstanding safety and stability performance.

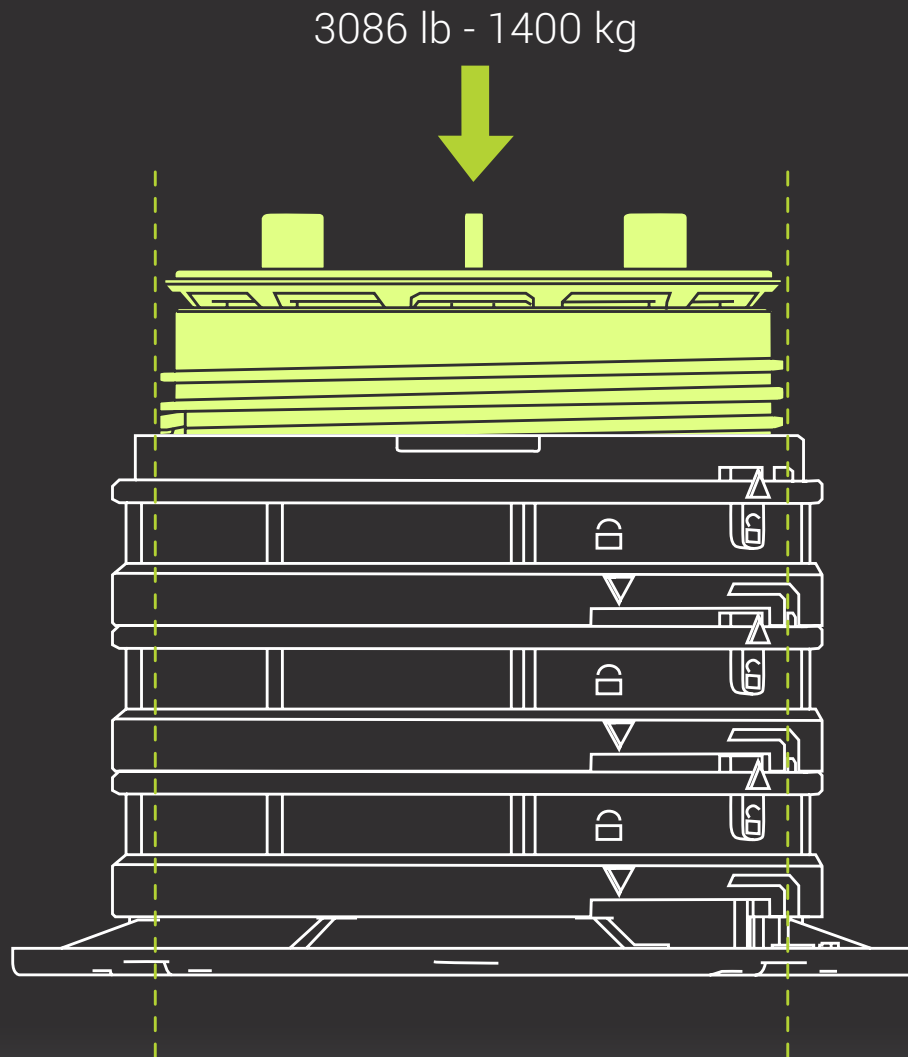

ACCESSORIES

SUPACLPB

Clip for perimeter - Base to hold 3/4" (2 cm) tiles



SUPACLPT

Clip for perimeter - Head to hold 3/4" (2 cm) tiles



SUPACLPP

Perimeter tile spacer to hold tiles



SUPL2 - SUPL3

Leveling disk
3/32" (2 mm) and 1/8" (3 mm) and
uptec FX slope compensation

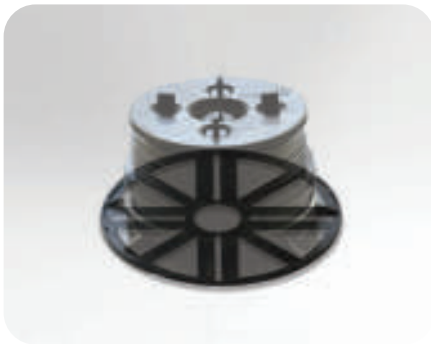

SUPAR120

Modular ring
of 4-3/4" (120 mm)
height



SUPATG

Mat for substrate
protection



PERIMETER BORDERS

Profilitec offers a wide range of high-quality border profiles, raised floors with uptec and uptec FX systems can be vertically finished with a choice of 3 different perimeter profiles that fully meet architectural requirements in terms of installation heights, configurations and colors.

BSJ

Profile with decorative visible part of 3/4" (2 cm)



BSR

Perimeter profile for 3/4" (2 cm) tiles



BST

Profile with minimal top-visible edge



Standard finishes:



Finishes on demand:

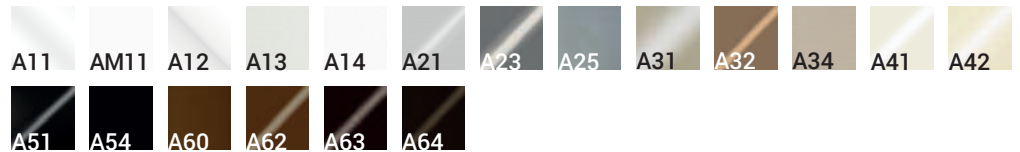

Perimeter border available for both uptec and uptec FX

PERFORATED JOIST WITH RUBBER INSERT

SUPAANG240 is a patented aluminum joist for raised floors that offers freedom and flexibility in the choice of materials, size, and flooring installation pattern.

Anti-slip and anti-noise rubber

The upper part is equipped with two special rails where anti-slip and anti-noise rubber gaskets are inserted. The joist is supplied with pre-applied rubber, saving installers valuable time and ensuring a quick and easy installation.

Punched openings

The lower part includes openings that ensure perfect water outflow and allow for height adjustment during and after installation. Additionally, the dented geometry of the openings ensures a secure and stable attachment to the head of the pedestal.



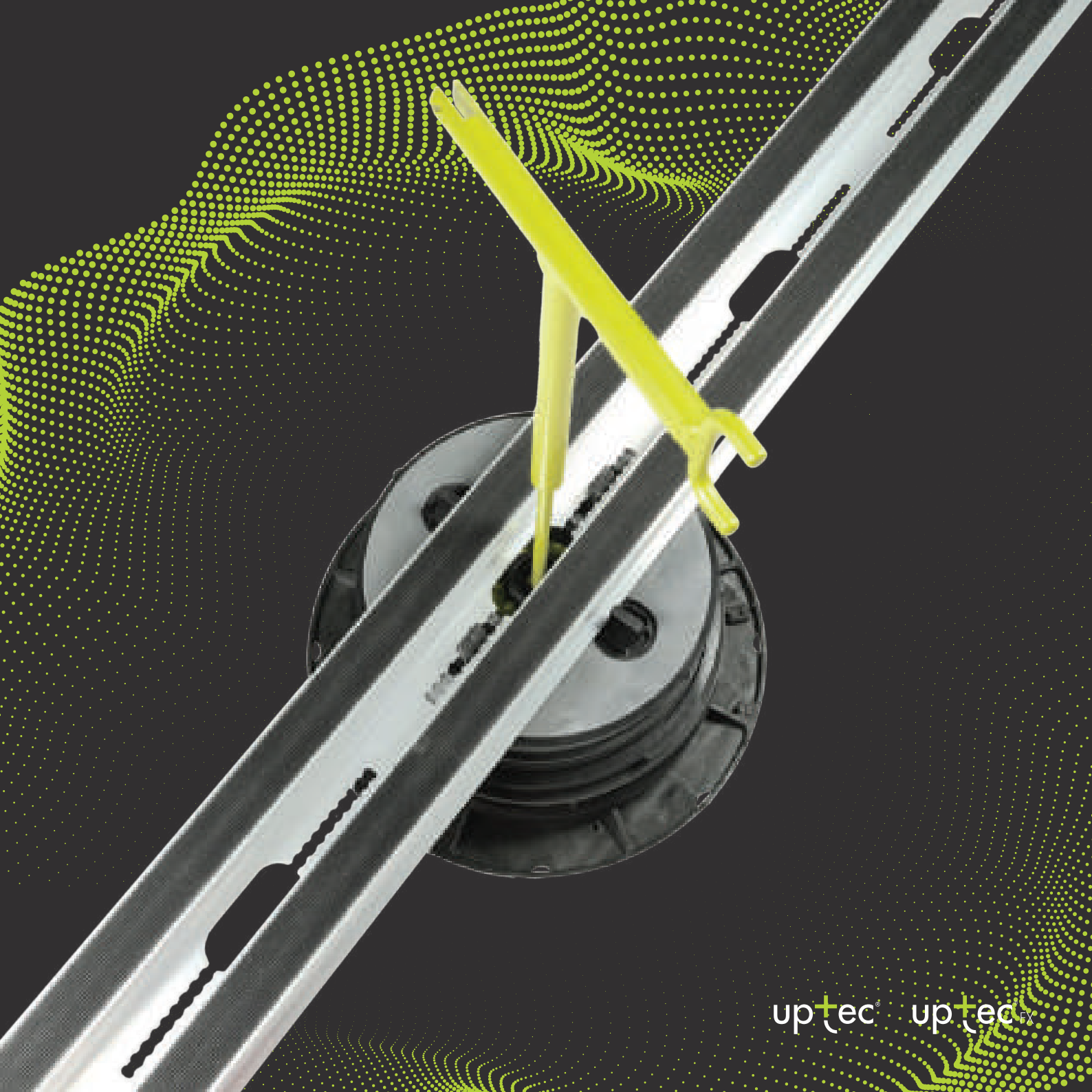

up+tec® up+tec®

FEATURES AND FUNCTIONS



SUPAANG240 offers maximum freedom and flexibility in terms of tile sizes to be used and allows for floors with different laying options and various covering materials.



SUPAANG240 ensures maximum performance for a structurally stable, safe and quick installation.

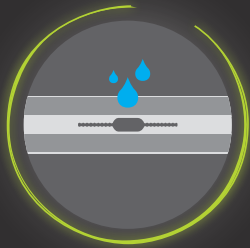

Openings on the base ensure proper water outflow.

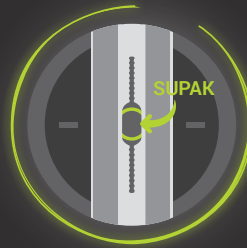

Openings on the base allow the height to be adjusted with the SUPAK key during and after installation.



SUPAANG240 comes with the anti-noise rubber bands already installed to save installers valuable time.

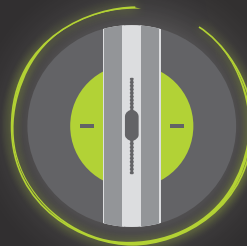

Openings on the base ensure safe and stable attachment to the pedestal head.

JOIST SYSTEM ACCESSORIES

SUPDG

Tile spacer
to be used with SUPAANG240



SUPCLIPG

Perimeter and central clips
to be used with decking and in
combination with SUPAANG240

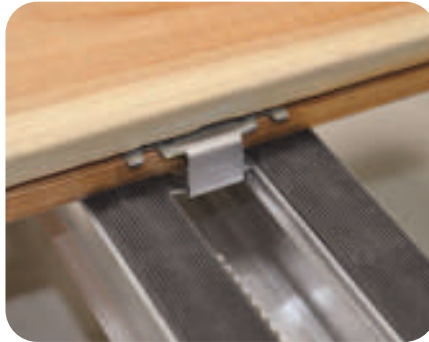

SUPAJG

Joist junction



SUPACLPPT

Perimeter tile spacer
to hold tiles



Accessories available for both uptec and uptec FX

up+tec[®]

CALCULATOR

www.profilitec.com/uptec-configurator

Uptec pedestal calculator is an online program to create your own raised floor and calculate the number of supports required for your project.

It is possible to design the area or upload an architectural drawing, choose from an extensive list of tile sizes, select the width of the joints, and set the desired height of the flooring. The Uptec pedestal calculator automatically determines which and how many supports and accessories are required for the project.

It is an easy and intuitive tool that offers a wide range of functions to simplify your work. It also provides additional information such as calculation of tiles to be used and lb (kg) of CO₂ saved per ft (m²) of floor area.



EPD Certification

Uptec is EPD certified. In building assessments, building products are evaluated through environmental product declarations (EPDs) conducted in accordance with ISO 14025 and EN 15804:2012+A2:2019.

The analysis evaluates the life cycle of the Uptec system and measures it in terms of carbon footprint with independent third-party verification of the statement and data, according to ISO 14025:2006. A series of case studies have shown that Uptec has an improvement of more than 70 percent in terms of carbon footprint over traditional methods of exterior floor assembly, such as glued tiles on a lightweight screed.



Discover more



EPD

ZERTIFIZIERUNG

SYSTEM COMPONENTS AND ACCESSORIES

Code	Product description	Pieces for packaging
SUPAL	Low pedestal	24
SUPAS	Standard pedestal	24
SUPALFX	Low fixed head pedestal	24
SUPASFX	Standard fixed head pedestal	24
SUPAR	Modular ring of 1 3/16" (30 mm)	24
SUPAR120	Modular ring of 4 3/4" (120 mm)	24
SUPT	Reduced height pedestal with 5/64" (2 mm) tabs	50
SUPT4	Reduced height pedestal with 5/32" (4 mm) tabs	50
SUPB	Extension for SUPT/SUPT4 pedestals	50



SUPAL



SUPAS



SUPALFX



SUPASFX



SUPT - SUPT4



SUPB



SUPAR



SUPAR120

Code	Product description	Pieces for packaging
SUPA2	Head with 5/64" (2 mm) tabs	240
SUPA4	Head with 5/32" (4 mm) tabs	240
SUPAW	Head to be fixed on wooden joists	240
SUPA2FX	Head with 5/64" (2 mm) tabs for low fixed head pedestals	240
SUPA4FX	Head with 5/32" (4 mm) tabs for standard fixed head pedestals	240



SUPA2



SUPA4



SUPAW



SUPA2FX



SUPA4FX

Code	Product description	Pieces for packaging
BSJ	Perimeter profile	10
BSR	Perimeter profile	5/10
BST20	Perimeter profile	5
SUPL2	3/32" (2 mm) leveling disk	600
SUPL3	1/8" (3 mm) leveling disk	500
SUPATG	Mat to protect the substrate	24
SUPACLPBSET5	Perimeter clip - Base	5
SUPACLPTSET5	Perimeter clip - Head	5
SUPACLPPSET5	Perimeter clip	5
SUPAK	Multifunction key	1



Code	Product description	Pieces for packaging
SUPAANG240	Aluminum joist for SUPA4 and SUPA4FX	10
SUPAANGB240	Black aluminum joist for SUPA4 and SUPA4FX	10
SUPDG	Tile spacer	500
SUPCLIPG	Perimeter and central clips (Deck)	50
SUPAJGSET20	Joint for joist	20
SUPACLPPT	Perimeter clip to hold tiles	5



up+tec®



www.profilitec.com



Profilitec S.p.A.



Via Scotte, 3
36033 Isola Vicentina
(Vicenza) Italy



profilitec@profilitec.com



+39 0444 268311

Profilitec Corp.

472 Meeting Street
Suite C - #301
Charleston, SC 29403, USA

customerservice@profilitec.com

+1 855 290 9591

BOOKUPT/EN

