

Eclipse
PreXion3D



PreXion™

The Quality Leader in 3D Cone Beam CT

The Complete 2-in-1 or 3-in-1 Multi-modality Solution

PreXion, with over 15 years of innovation in the medical and dental fields, introduces the **PreXion3D Eclipse**. The **PreXion 3D Eclipse** – a true 2-in-1 or 3-in-1 multi-modality solution – combines the superb image quality that you have come to expect from the PreXion3D Elite with enhanced versatility – all at an affordable cost that will benefit you and your patients.

Ideal for dental offices that want to perform in-office surgical implant procedures, the **PreXion3D Eclipse** also excels at 3D imaging for diagnosis in general dentistry, periodontics, orthodontics, and endodontics, along with planning in oral-maxillofacial surgery.

Included with your **PreXion3D Eclipse** is the **PreXion3D Viewer Software** – a breakthrough program that contains easy-to-use modules for evaluating dedicated 2D Panoramic, 2D Cephalometric, and 3D images. Utilizing fully integrated software with state-of-the-art imaging technology, PreXion provides the clinician with the most accurate assessment of bone and surrounding anatomy.

The **PreXion3D Eclipse** also comes with the **PreXion data server solution**, which allows you to seamlessly integrate our technology into your office – no additional hardware required, no costly network upgrades, and no hidden charges.



A New Dimension in Imaging

A Powerful Visual Aid for You and Your Patients

The **PreXion3D Eclipse** boasts the smallest focal spot size in the industry – providing clinicians with the highest quality image without distortion.

3D images help visualize dental anatomy via multiplanar and double oblique views, including the option for dynamic rotational slices – creating

excellent tools for diagnosing clinical criteria with higher levels of accuracy.

In addition, the stunning images generated by the **PreXion3D Eclipse** provide a powerful visual aid for educating patients on available treatments.

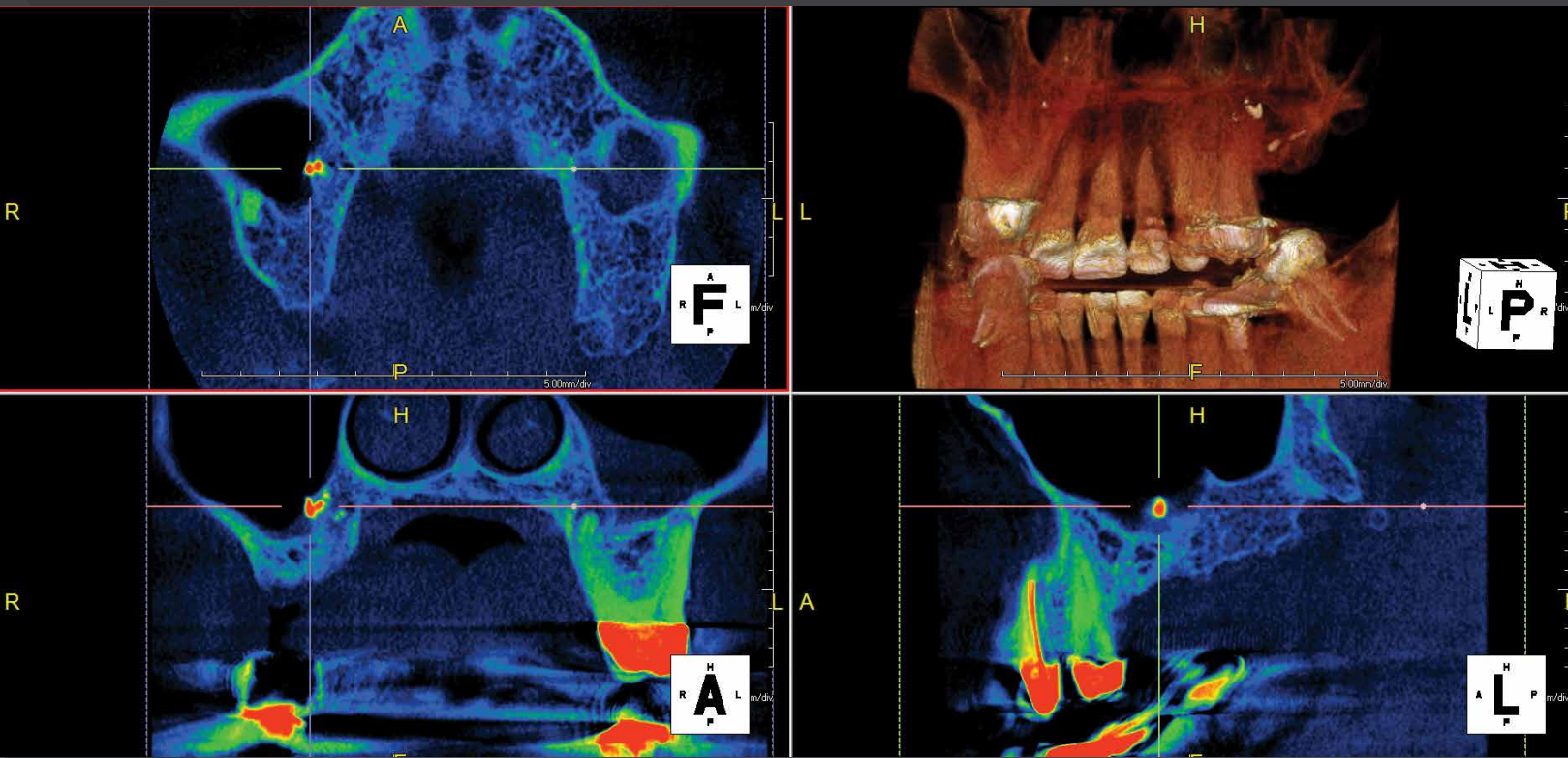

»» PreXion3D Eclipse's 3D image

Highest Resolution

A smaller focal spot increases resolution. The **PreXion3D Eclipse** uses a 0.2 mm focal spot – smallest in its class.

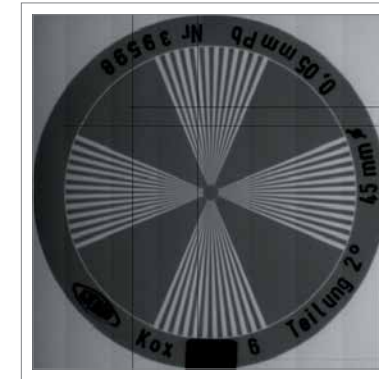

Sharp
0.2 mm PreXion3D

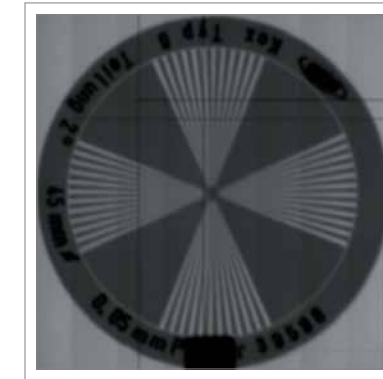

Blurred
0.5 mm average

Comparative Superiority

Traditional panoramic images cannot evaluate the full buccal-lingual width. With 3D images generated by the **PreXion3D Eclipse**, clinicians can evaluate cases from different angles and planes, resulting in more accurate diagnoses.

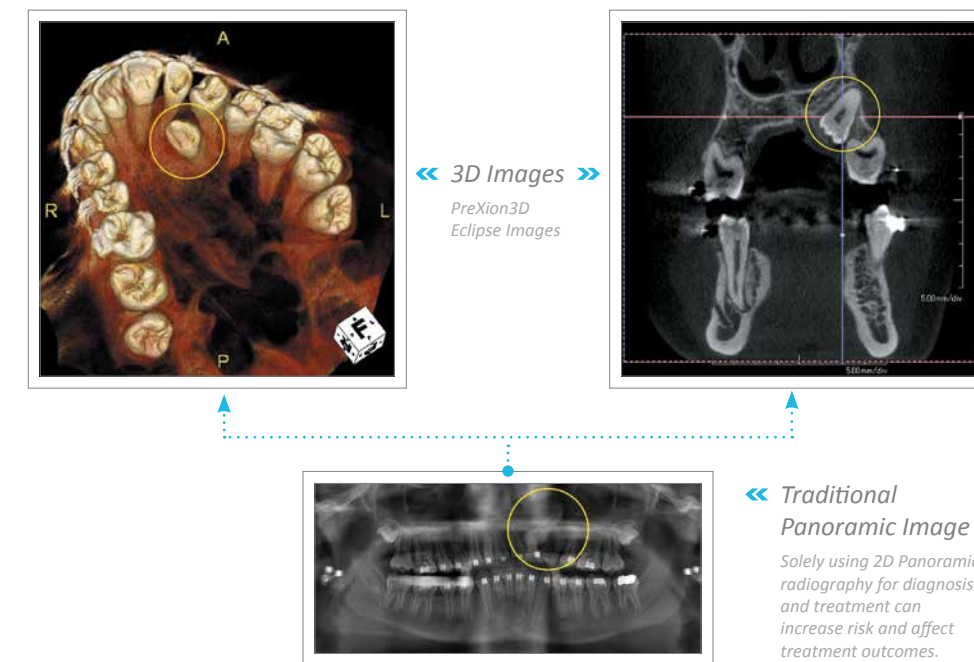

Get the Right Picture

The PreXion3D Eclipse Offers Two Fields of View (FOV) and Four Scanning Modes for Precise Diagnoses

PreXion leads the market in the quantity and quality of projected views per scan, resulting in clearer, higher quality images for your diagnosis. All PreXion3D Eclipse scan sizes are safe for general practitioners to read and do not require licensed radiology reports.

Light Mode

- » FOV 81 mm x 75 mm
- » Scan Time 8.7 secs
- » Projected Views 269

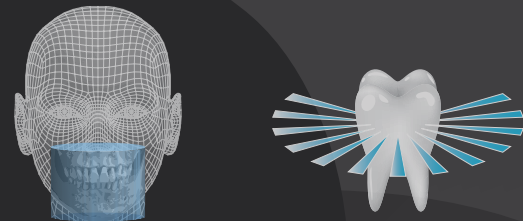

High Definition Mode

- » FOV 81 mm x 75 mm
- » Scan Time 8.7 secs
- » Projected Views 269

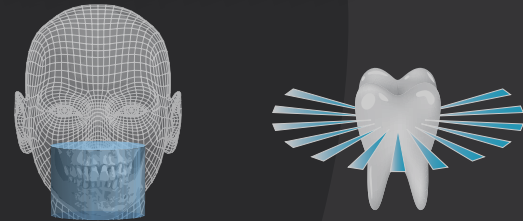

Ultra High Definition Mode

- » FOV 81 mm x 75 mm
- » Scan Time 17.4 secs
- » Projected Views 538

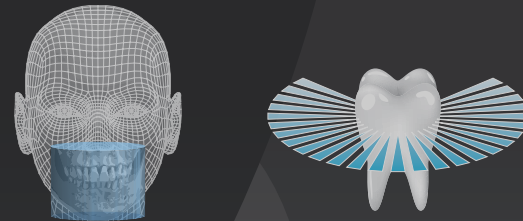

Wide Mode

- » FOV 113 mm x 72 mm
- » Scan Time 9.1 secs x 2 times
- » Projected Views 564

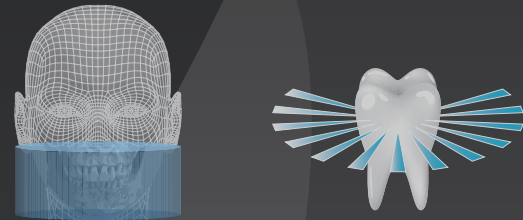

« Simultaneous Panoramic Image

Panoramic images are automatically generated with each scan. No separate panoramic scan is required.

Flexible Capabilities with Dedicated Pan and Ceph

Easily capture dedicated 2D panoramic for post-op or general exams. Optional Ceph is great for Orthodontics.



» Panoramic Modes

Mode	Scan Time
Standard	16 secs

« Dedicated 2D Panoramic Image



» Cephalometric Modes

Mode	Scan Time	Picture Size
PA	12 secs, 15 secs	7.99 in x 10.00 in / 203 mm x 254 mm
LA	10 secs, 12 secs	12.01 in x 10.00 in / 305 mm x 254 mm
Carpus	8 secs	8.00 in x 10.00 in / 203.2 mm x 254 mm

« Cephalometric Image

PreXion Diamond Warranty and Direct Sales & Support

PreXion's direct sales and support offers a superior advantage over dealerships.

- » Covers 100% parts and labor with no additional fees or deductibles
- » Includes 1 full day on-site training
- » Includes software updates and phone support
- » Includes exclusive access to PreXion Online Help Center

Superior Clinical Results

Implant

PreXion3D can provide you with the highest quality images for both pre- and post-op assessment. Accurate evaluation of the implant position and the bone thickness can be quickly & accurately evaluated. DICOM data can be transferred for use in surgical guide fabrications and accuracy in the placements of dental implants.

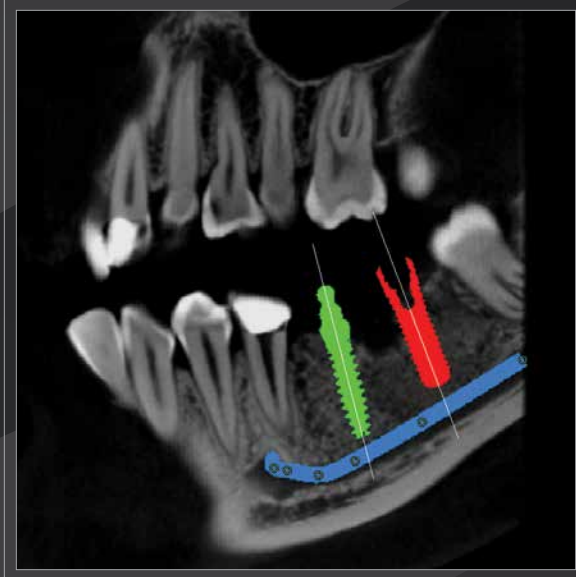
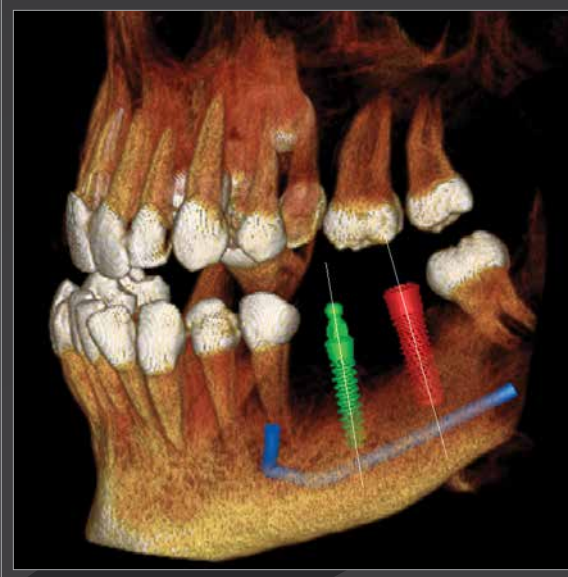

TMJ

The clarity and crisp detail of PreXion's 3D imaging provides accurate assessment of the position and condition of the condyle. Measurement tools provide exact distances between the condyle and the bony fossa giving precise detail in aiding the design and/or positioning of corrective appliance.



The PreXion3D Eclipse Provides Clinicians with the Highest Quality Images for Exceptional Clinical Results

Endo

Eclipse scans aid in both pre-endo treatments plus evaluation of post re-treatments of endodontic failures. Information gathered from the cone beam scans can accurately determine if a re-treatment will be successful or if the tooth requires an extraction.



Perio

The combination of 3D and multi-slice cone beam CT images provides a clear understanding of the bony defects within relation to surrounding anatomy. In addition to helping the dentist plan for treatment options, 3D CBCT imaging is an excellent tool for educating patients about their own perio issues and bone degeneration resulting in better treatment acceptance.

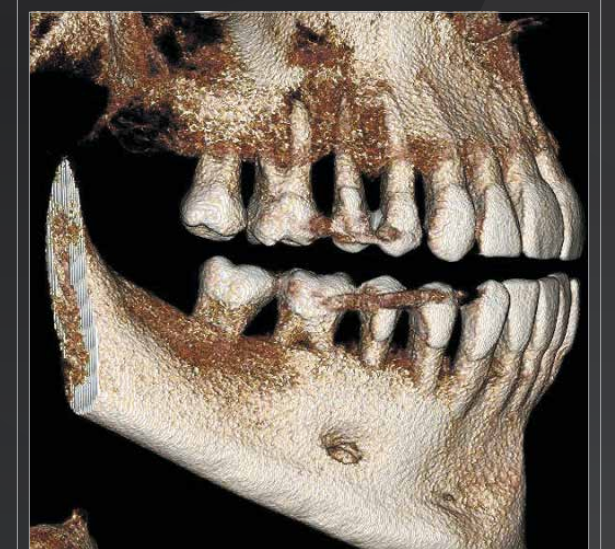

Superior Clinical Results (cont.)

Molar

Both upper and lower molars are more accurately evaluated for position, number of root canals, and the distance near the inferior alveolar canal if extractions are planned. Excellent for impacted third molar studies to distal third roots. Rotational and multi-slice features further enhance the accuracy of evaluations, especially with deep or curved roots. In addition, the Wide mode feature allows dentists to view the entire distal 3rd molar root.

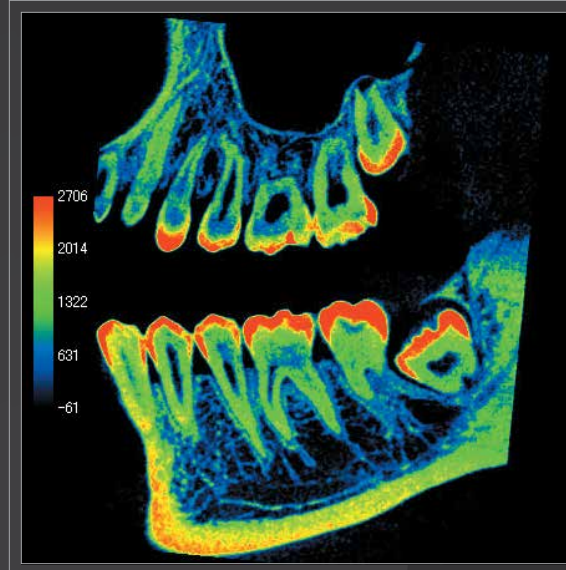

Bone Augmentation

Pre-surgical planning is essential for successful bone grafts. Accurate measurements for graft materials, membranes or surgical meshes can be accomplished prior to actual surgery. An additional benefit is the ability to accurately gauge the amount of graft material needed resulting in cost savings. Bone density can also be measured and determined prior to surgery.

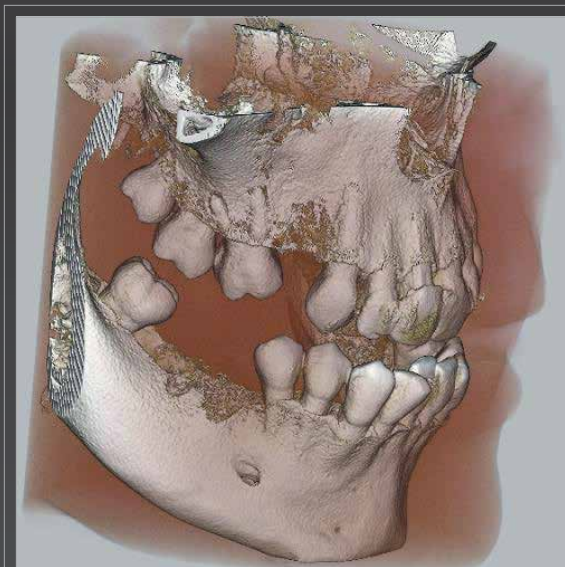

Maxillary Sinus

The sinus floor is included in a standard scan. Accurate diagnosis and evaluations of the sinus, including the nasal septum, is an added benefit. This information is also crucial when planning sinus lifts for visualizing depth, volume, landmarks or septae to consider during the planning phase. Conditions of sinusitis may reveal mucus or thick buildup in the sinus cavity and can be evaluated in both 3D and MPR images.

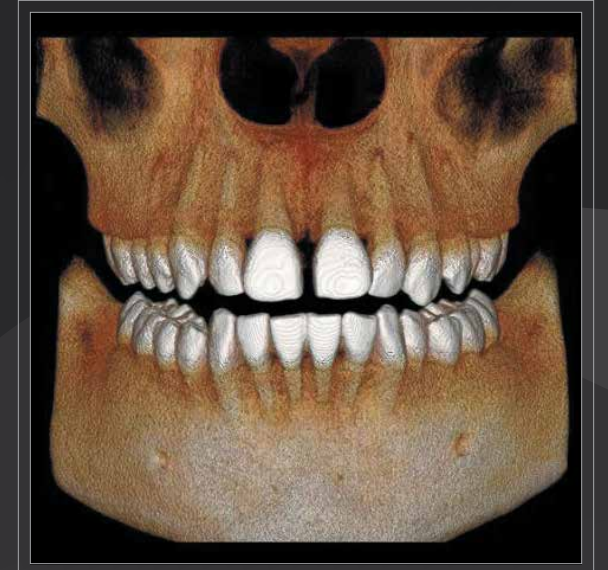
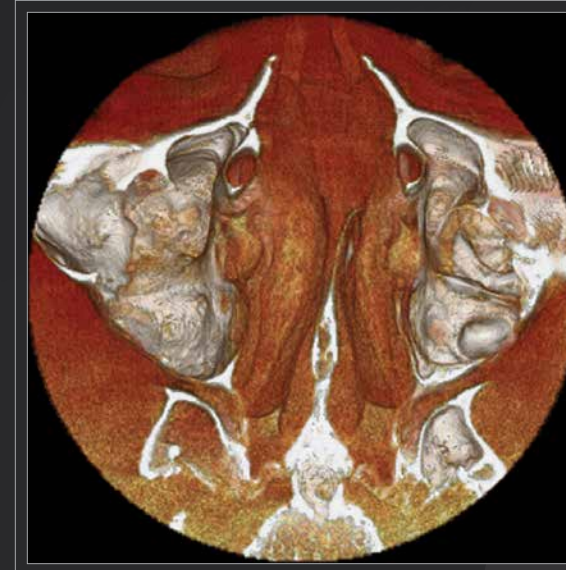

Root Abscess

The cause of root abscess such as endodontic failure and implants can be accurately evaluated using the high quality images of the PreXion3D system, and assist in exact treatment planning options.



Breakthrough Software

Fully Integrated PreXion3D Viewer Software

The **Prexion3D Viewer software**, included with the PreXion3D Eclipse at no additional charge, contains easy-to-use modules for evaluating dedicated 2D Panoramic, 2D Cephalometric, and 3D images. The **Prexion3D Viewer software** provides the clinician with the most accurate assessment of the bone and surrounding anatomy while making 1:1 exact measurements. This assures optimal implant placement without the superimposition of tissue or projection distortion compared to conventional panoramic systems. The **Prexion3D Viewer** images reconstruct to DICOM 3.0 format and are compatible with major 3rd party surgical planning software systems.

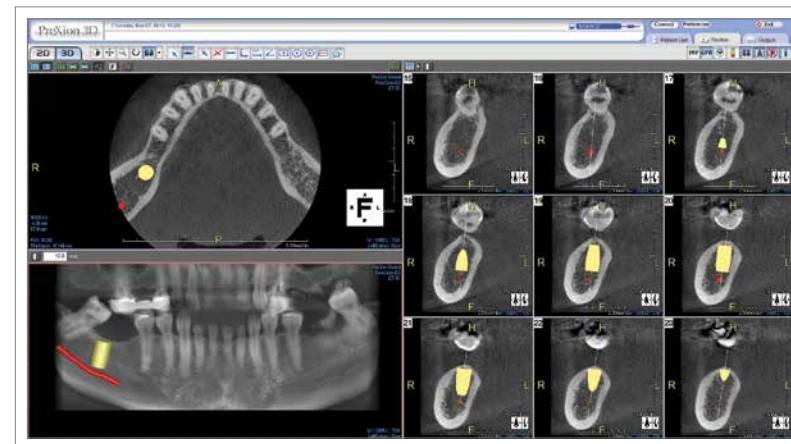

Prexion3D Viewer Curved Planar Reconstruction (CPR) Mode

Create custom troughs around arches and view cross-sections trans-axially.

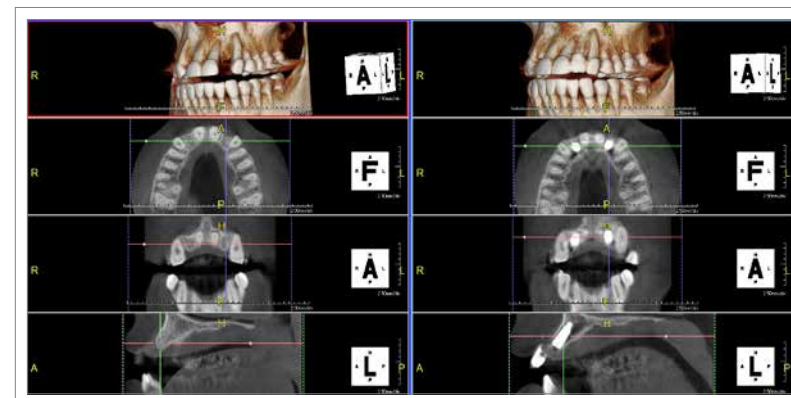

Multi-Data View

Easily compare pre-operative scans with post operative scans, synchronize them and quantify measurable results on a single screen, slice-by-slice.



PrexViewer CD

Make patient discs with 'free' 3D viewer.

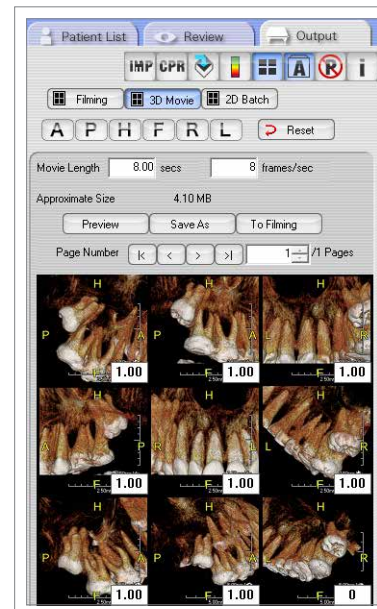

Prexion3D Movie Maker

Easily create compelling 3D animated movies for patients and increase understanding and case acceptance.

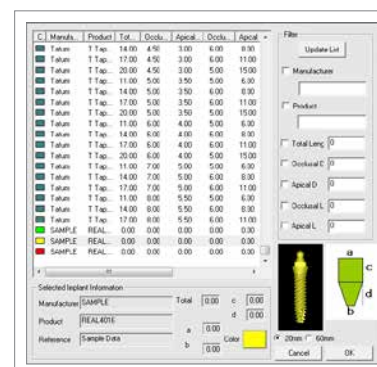

Implant Planning

Easily locate and mark the Inferior Alveolar Nerve, measure 1:1 ratios, place and move implants in 3D.

Seamless Workflow

"Scan Once, View Many" with the PreXion Data Server Solution

Prexion's 'scan once, view many' solution allows immediate access to 3D scans from any computer or laptop on the office network – without any hardware upgrades. The **Prexion Data Server solution** is unique because it won't slow down networks caused from downloading and loading scans from different rooms.

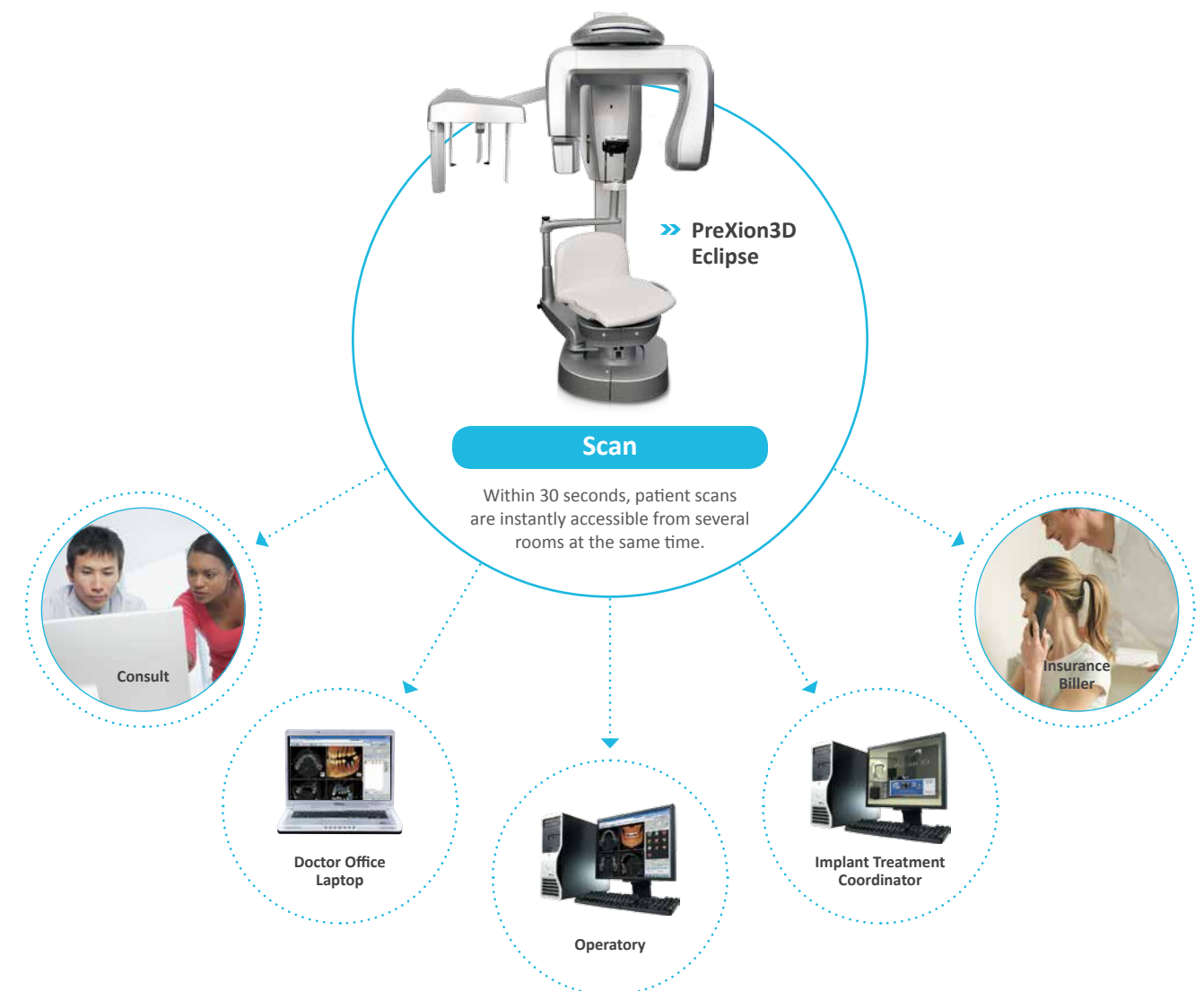

Compact Styling

Ergonomic design with a small footprint

The **PreXion3D Eclipse** offers a smart, stylish design that is both ergonomically-friendly to the patient and compact in size. The small footprint of the **PreXion3D Eclipse** allows it to fit in almost any location previously occupied by a panoramic x-ray system – with no office expansion typically necessary.



Ergonomic Design

The **PreXion3D Eclipse** has an ergonomically designed chair that results in a more relaxed and stable patient.



Live Video Camera with Scout View
Easily scan a desired region of interest.

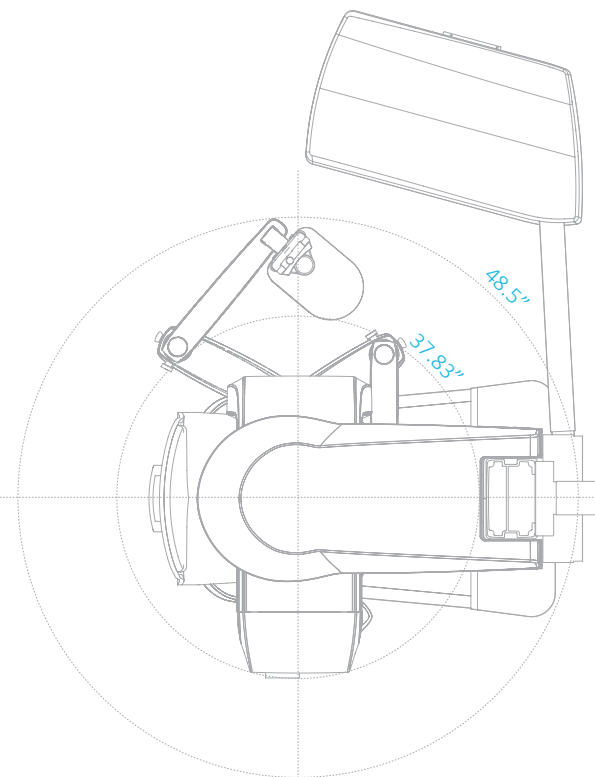

Compact Size

The size of the **PreXion3D Eclipse** allows it to fit in the same space as the panoramic x-ray system it is replacing.

Specifications

Device Type	CBCT + Panorex + Ceph (Optional)	
FOV (Diameter by Height)	Light Mode	3.18 in x 2.95 in / 81 mm x 75 mm
	High Definition Mode	3.18 in x 2.95 in / 81 mm x 75 mm
	Ultra High Definition Mode	3.18 in x 2.95 in / 81 mm x 75 mm
	Wide Mode	4.45 in x 2.83 in / 113 mm x 72 mm
Scan Mode	CT	Light Mode: 8.7 secs, High Definition mode: 8.7 secs Ultra High Definition mode: 17.4 secs, Wide mode: 9.1 secs x 2
	Panorex	Standard mode: 16 secs
	Ceph	LA, PA, Carpus: 8, 10, 12, 15 secs
X-ray Output	90 kV (50 to 90 kV in Ceph scan) 4 mA (1.0 to 4.0 mA in Ceph scan) *CT has 2.6 mA and 4 mA mode	
CBCT Sensor	FPD, 14 bits	
Focal Spot	0.2 mm (200 μm)	
Power	120 V, Single phase, 1.5 kVA	
Patient Position	Seated	
Included Computers	Two Computers: Console (1) and Viewer (1) – (Network Client is available)	

Dimensions

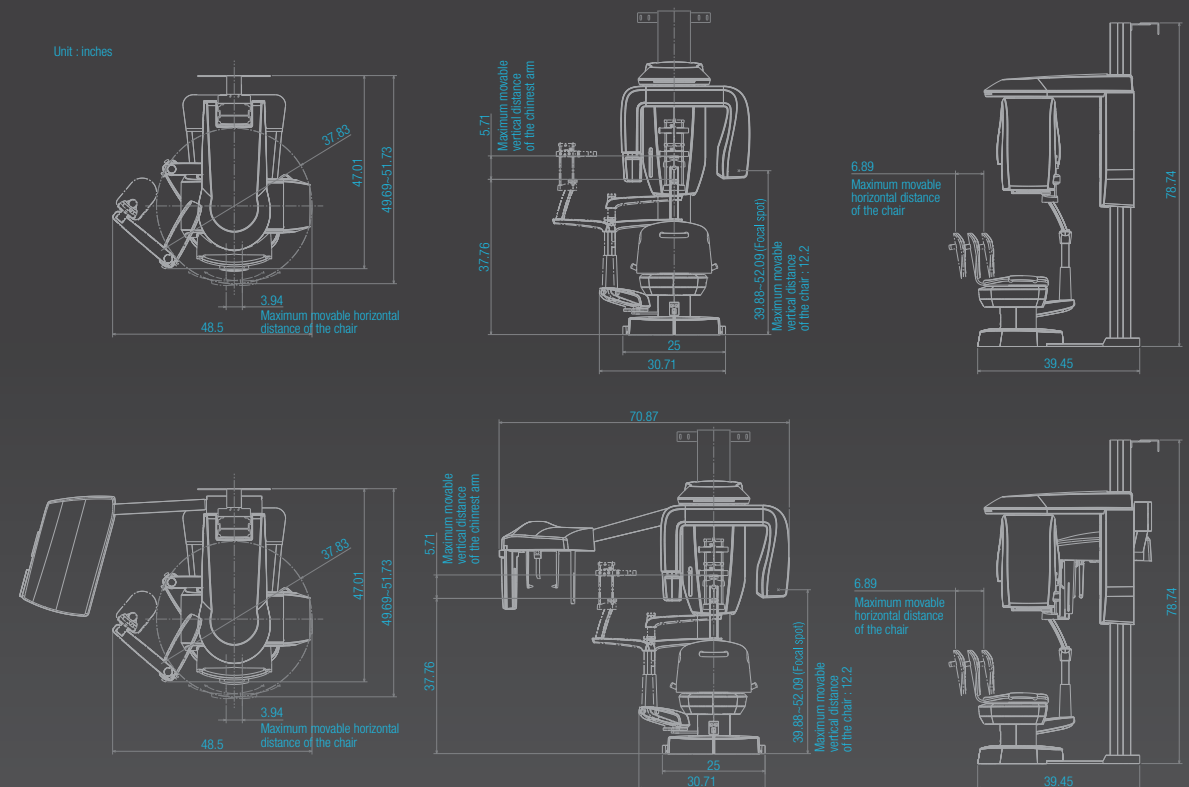



USA

PreXion, Inc.
411 Borel Avenue, Suite 550,
San Mateo CA 94403, USA
Tel:650-212-0300 Fax:650-212-0310
E-mail:info@prexion.com

www.PreXion.com

Japan

XTrillion
1-14-1 Kanda Suda-Cho, Chiyoda-ku Tokyo,
101-0041 Japan
Tel:+81-3-5297-2822 Fax:+81-3-5297-7552
E-mail:info@prexion.co.jp

www.PreXion.com