

PreXion3D Elite

WITH CLEARimage™ SCANNING TECHNOLOGY



PreXion

Quality Leader in 3D CBCT Imaging

QUALITY LEADER IN 3D CBCT IMAGING



Cone beam CT brings imaging to the next dimension by providing 3D images that allow dental diagnoses not seen before.

PreXion3D offers the highest image quality and most powerful software in the cone beam CT industry for precise implant planning, oral surgery, endodontics, periodontics, restorative, general dentistry and much more.

PreXion's advanced technology allows for greater functionality and provides you with excellent tools for diagnosing clinical criteria with higher levels of accuracy.

The stunning images generated by PreXion3D provide a powerful visual aid for educating patients to help explore the options of available treatments in the new standard of care. The investment in high quality diagnostic imaging will be one that greatly benefits both you and your patients.

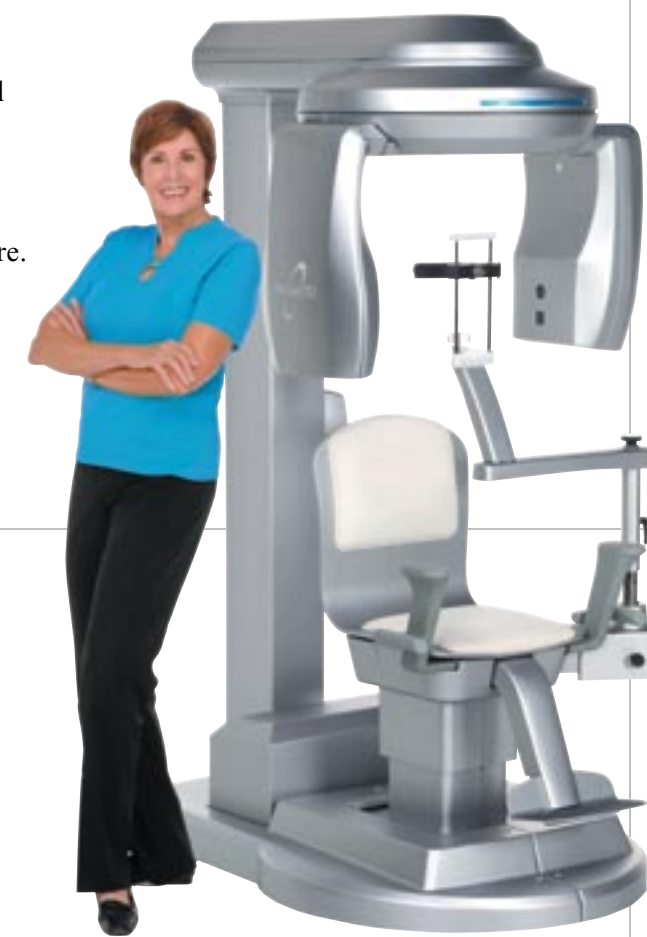

PRODUCT OVERVIEW

Industry Leading High Quality, Highly Diagnostic Images

Faster Scan Times

Four new scanning modes, all faster and with reduced radiation:

- Rapid** 8.6 (50% faster) second full mandible & maxilla scan for use in most clinical situations
- High Def** 16.8 (12% faster) second full mandible & maxilla scan providing higher resolution and detail for difficult clinical cases
- High Res** 16.8 (12% faster) second limited area scan providing higher resolution and detail for targeted quadrant diagnosis
- Ultra High Def** 33.5 (10% faster) second full mandible & maxilla scan providing the highest level of resolution and detail for maximum clarity and anatomical detail

Reduced Radiation

Lower doses while maintaining high image quality

- Rapid Mode** 50% Reduction
- High Def/High Res Modes** 12% Reduction
- Ultra High Def Mode** 10% Reduction

Main Features



• *Highest Image Resolution*

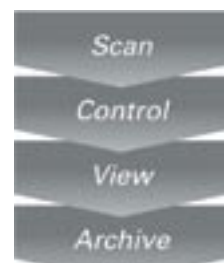

• *Seamless Workflow*

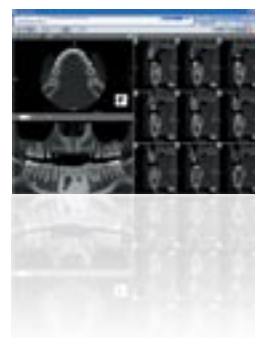

• *User-Friendly Interface*



• *Stylish and Compact*



HIGHEST IMAGE RESOLUTION

3D images enable you to visualize dental anatomy via multiplanar and oblique views including the option for dynamic rotational slices.

PreXion3D also offers the smallest focal spot size in the industry; making it possible to provide high quality images without any distortion.



PreXion's 3D image

Highest Resolution

Smaller focal spot increases resolution. PreXion3D uses a 0.2mm focal spot, smallest in class.



Sharp
0.2mm PreXion3D

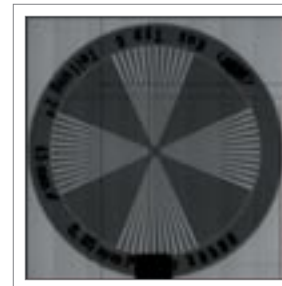

Blurred
0.5mm average

Comparative Superiority

Traditional Panoramic images cannot evaluate the full buccal-lingual width. 3D images can be evaluated from different angles and planes.

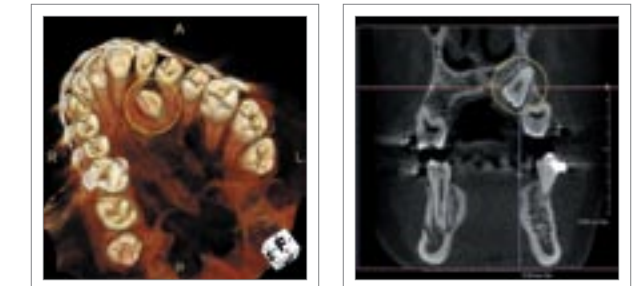

3D images

Traditional
Panoramic
image

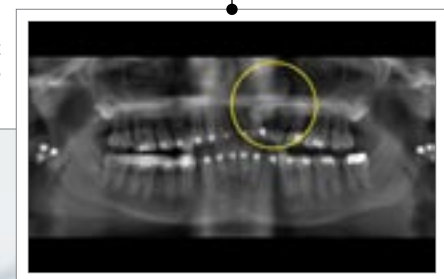

HIGHEST IMAGE RESOLUTION II

Four Scanning modes

Two Field's of View (FOV) and three scan modes allow you to select the best mode for your specific clinical need. You can select the appropriate one for your diagnosis.

FOV
<p>Full Mandible/Maxilla FOV Rapid, High Def & Ultra High Def Mode</p>
<p>Targeted/Directed FOV High Res Mode</p>

Scan Mode
<p>Rapid 8.6 sec. for 260 frame images</p>
<p>High Def & High Res 16.8 sec. for 512 frame images</p>
<p>Ultra High Def 33.5 sec. for 1024 frame images</p>



Flat Panel Detector

Produces highly detailed and brilliant digital images.



Simultaneous Panoramic Image

Panoramic images are automatically generated with each scan. No separate panoramic scan is required.



USER-FRIENDLY INTERFACE

PreXion3D viewer software's interface is extremely intuitive and easy to use with a simple PC mouse, which enables anyone to easily operate the powerful PreXion3D software.

Diagnostic images can be easily obtained with simple operation. The simulating function for implant and oral surgery planning are included in the software.

3D & MPR images can be seen and operated from any operatory.

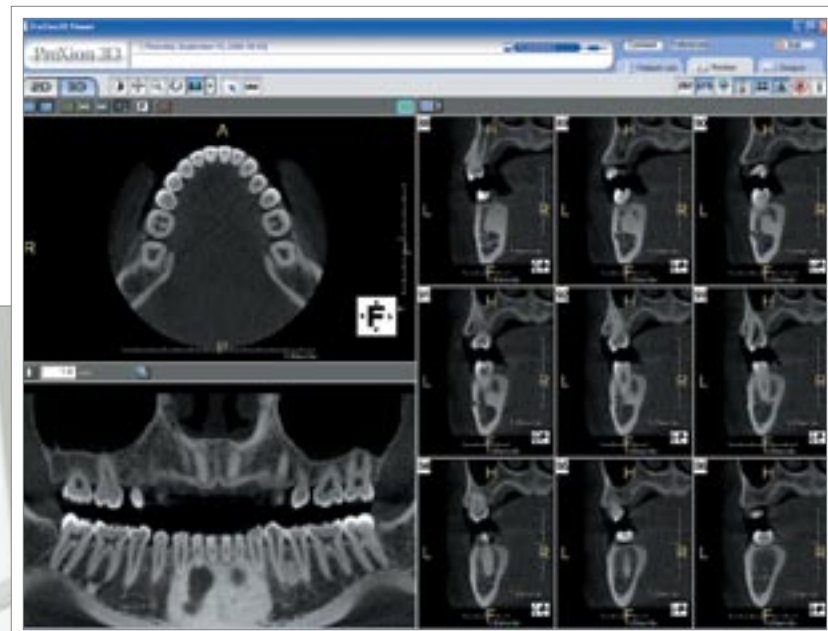

PreXion3D Viewer

User-friendly interface designed for quick diagnoses.

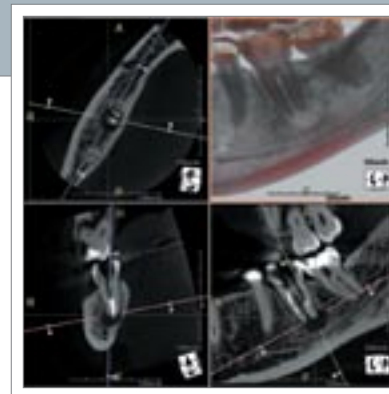

Double Oblique Function

Resliced images can be examined from any angle or direction.



Implant Planning

The implant planning can be confirmed on the 3D images in real time. Implant Planning makes it easy to explain and confirm the pre and post-operational diagnoses to the patients.

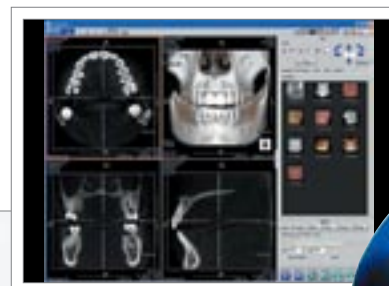

PreViewer

Real-time 3D and CT images can be downloaded to a CD with PreViewer software. Allows referring doctors or clinics to evaluate the PreXion CBCT scans from the CD media. The scanned patient data on PreViewer CD is fully interactive and can be manipulated & measured in 3D & MPR views.

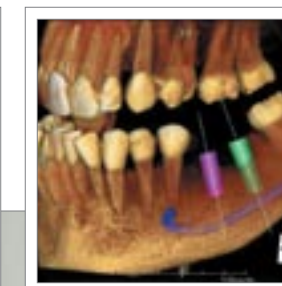

DICOM 3.0 format compatible with major 3rd party software and systems.

USER-FRIENDLY INTERFACE II

Operators can perform scans easily & quickly. The field of view can be adjusted with proper positioning of the patient.

Proper patient seating and positioning helps to achieve higher quality scans.

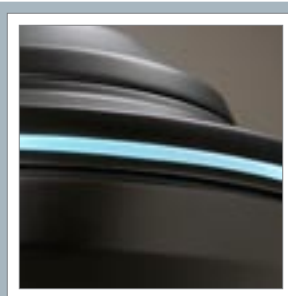

Colored Lights indicate the status of the scan.

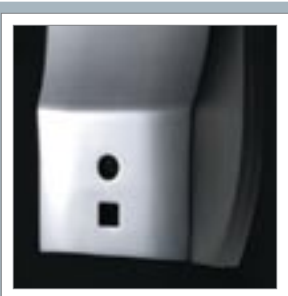

A camera focuses on the patient to achieve the right position to get appropriate images within seconds.

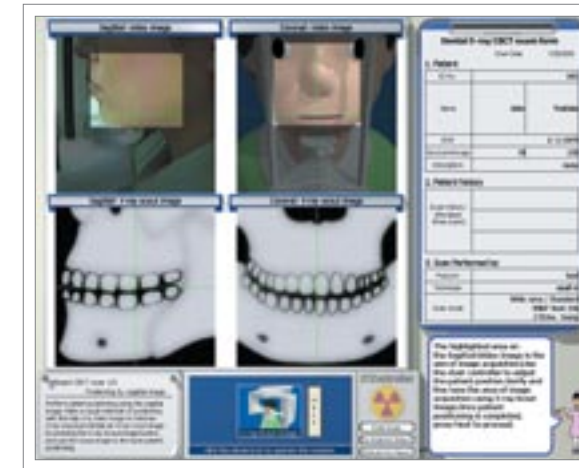

Patient Positioning Screen

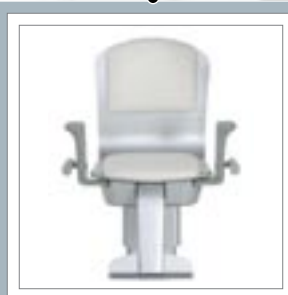

The chair can be remotely & easily moved from right to left, forward to backward and up and down for correct position.



CT Scanner



SEAMLESS WORKFLOW

PreXion3D provides you with a seamless and fast operating environment to efficiently manage scanning functions, image processing, patient study recall and data management.

PreXion's advanced & proprietary image transfer technology enables you to rapidly & seamlessly access patient cone beam CT data from anywhere you wish within your networked facility.

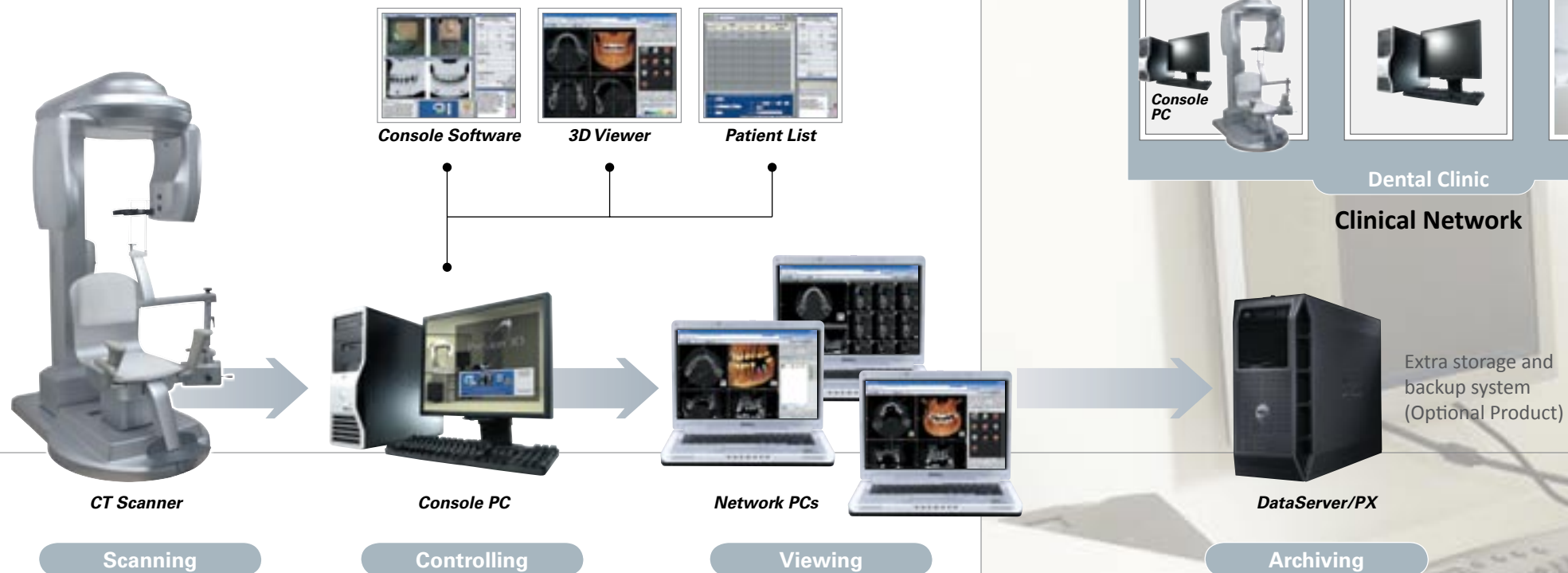

PreXion3D's image transfer technology enables you to quickly, easily access data anytime from anywhere.

3D images in the server can be quickly shared with client PCs anywhere on the network and without having to download patient datasets to each computer.

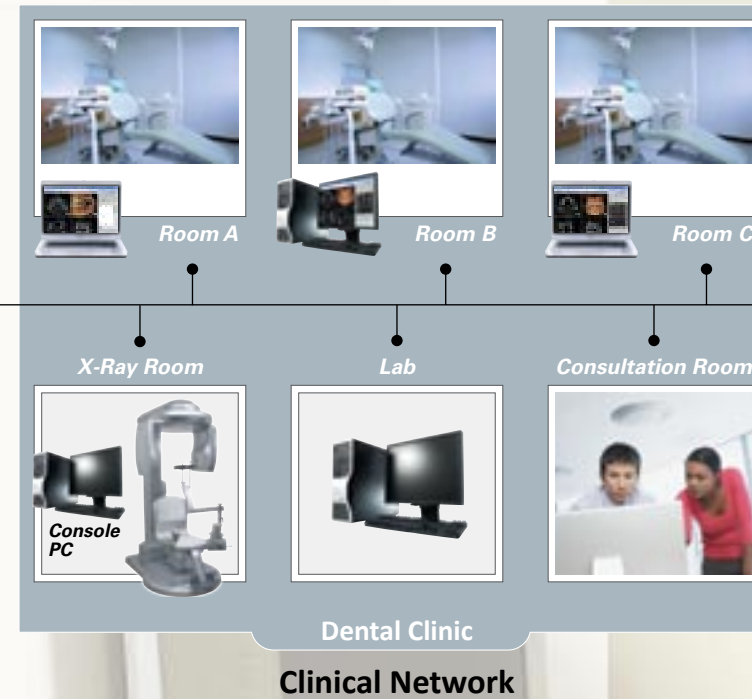

Secure DICOM Server for automated archiving of CT scan data. (DICOM 3.0 support)



STYLISH AND COMPACT

PreXion's high-tech, stylish and comfortable design is one of the most compact of all CBCT scanners and fits in almost any location previously occupied by a panoramic x-ray system. No office expansion is typically necessary.



Stylish Design

Stylish design and high-end technology impresses patients.

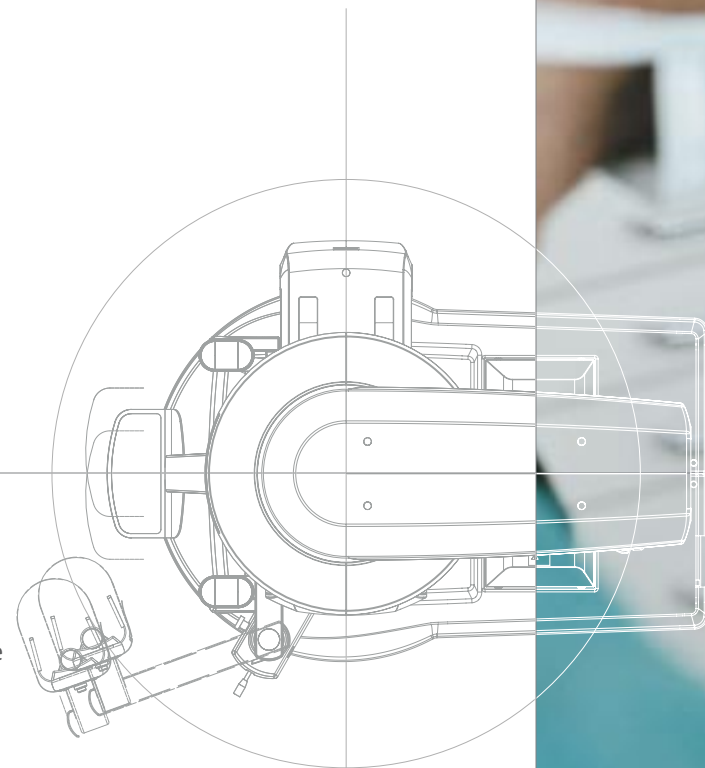

Compact Design

The compact design allows the PreXion3d to fit in the same space as the panoramic x-ray system it is replacing.



Clinical Case I

Implant

PreXion3D can provide you with the highest quality images for both pre & post op assessment. Accurate evaluation of the implant position and the bone thickness can be quickly & accurately evaluated. DICOM data can be transferred for use in surgical guide fabrications and accuracy in the placements of dental implants.

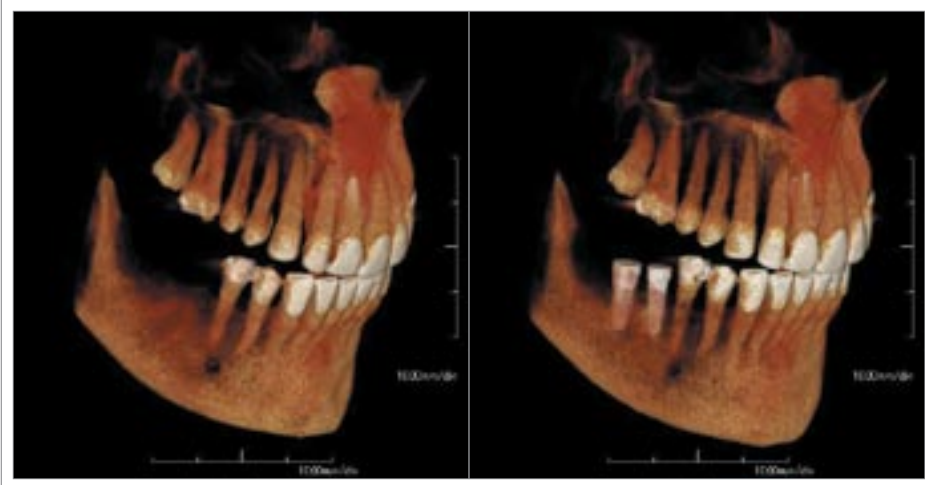

TMJ

The clarity and crisp detail of PreXion's 3D imaging provides accurate assessment of the position and condition of the condyle. Measurement tools provide exact distances between the condyle and the bony fossa giving precise detail in aiding the design and/or positioning of corrective appliance.

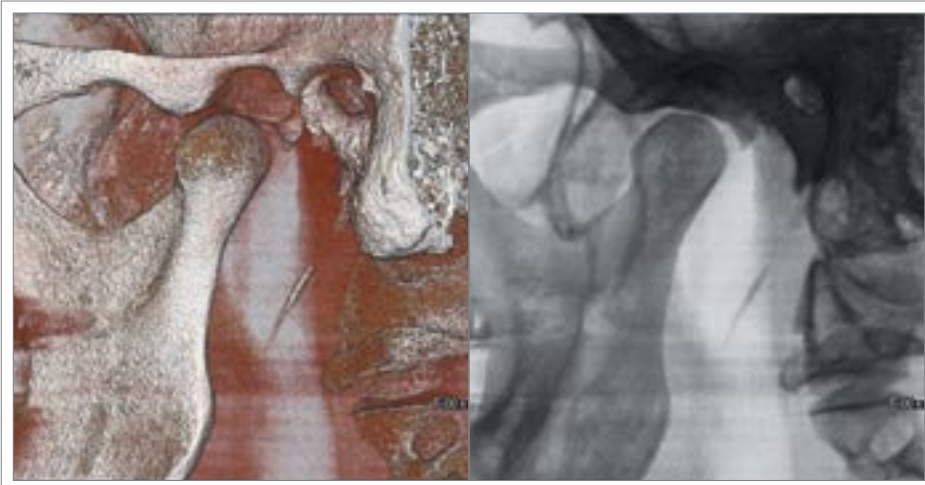

Endo

PreXion scans aid in both pre-endo treatments plus evaluation of post re-treatments of endodontic failures. Information gathered from the cone beam scans can accurately determine if a re-treatment will be successful or if the tooth requires an extraction.



Perio

The combination of 3D and multi-slice cone beam CT images provides a clear understanding of the bony defects within relation to surrounding anatomy. In addition to helping the dentist plan for treatment options, 3D CBCT imaging is an excellent tool for educating patients about their own perio issues & bone degeneration resulting in better treatment acceptance.



Clinical Case II

Molar

Both upper and lower molars more accurately evaluated for position, number of root canals and also the distance near the inferior alveolar canal if extractions are planned. Rotational and multi-slice features aid greatly and especially with deep or curved roots.

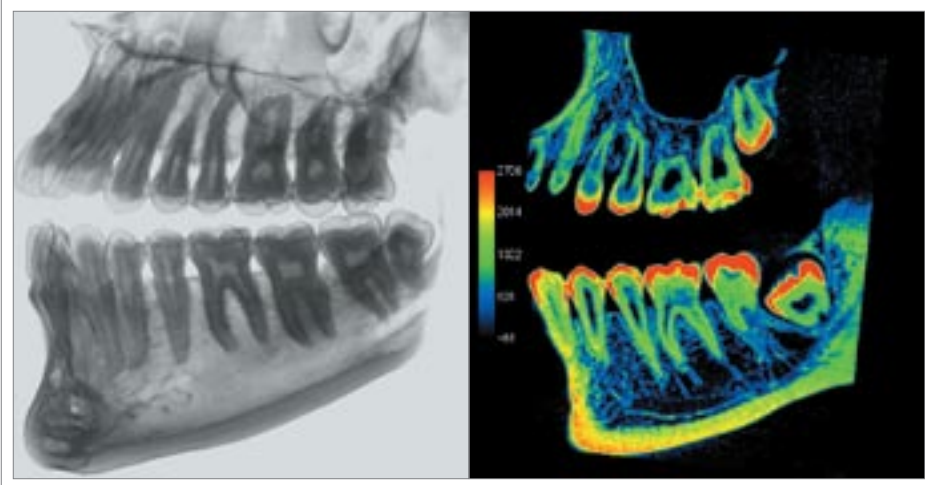

Bone Augmentation

Pre-surgical planning is essential for successful bone grafts. Accurate measurements for graft materials, membranes or surgical mesh can be accomplished prior to actual surgery. An additional benefit is the ability to accurately gauge the amount of graft material needed resulting in cost savings. Pixel Bone density can also be measured and determined prior to surgery.

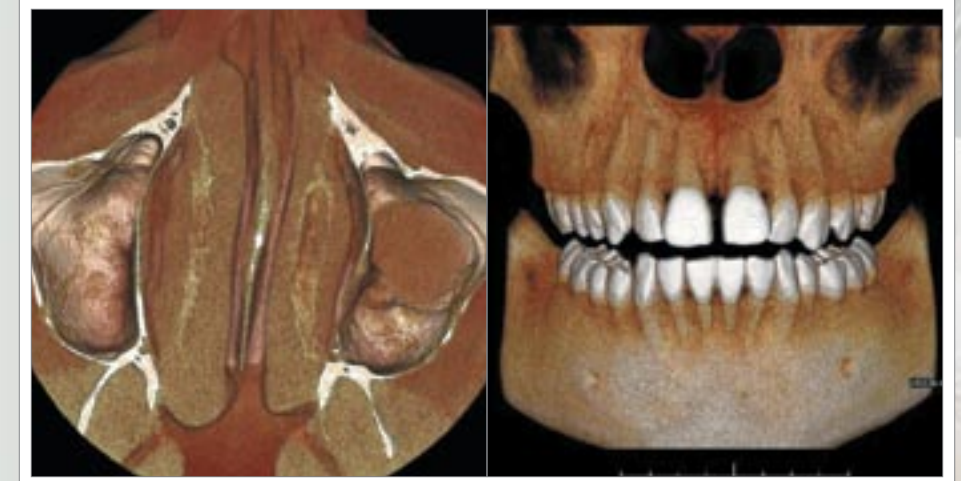
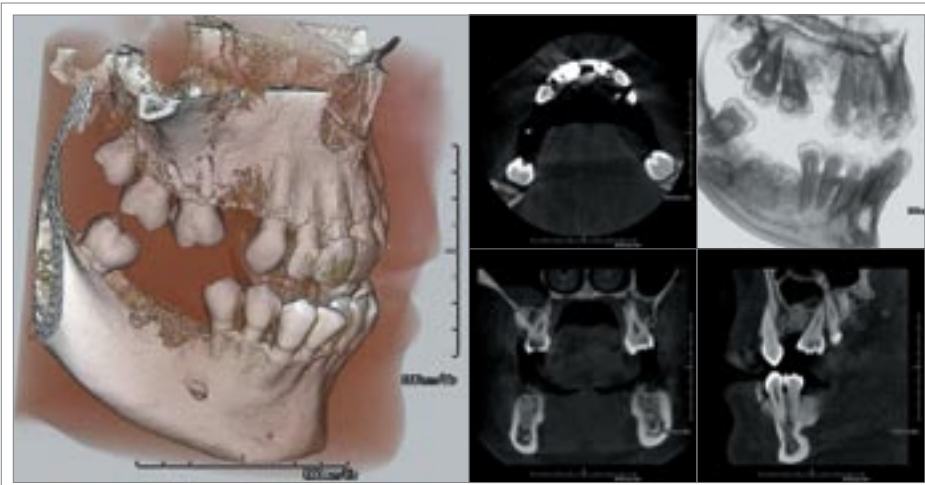

Maxillary Sinus

The sinus floors are included in a full arch scan. Accurate diagnosis and evaluations of the sinus, including the nasal septum, is an added benefit. This information is also crucial when planning sinus lifts for visualizing depth, volume, landmarks or septae to consider during the planning phase. Conditions of sinusitis may reveal mucus or thick buildup in the sinus cavity and can be evaluated in both 3D and MPR images.

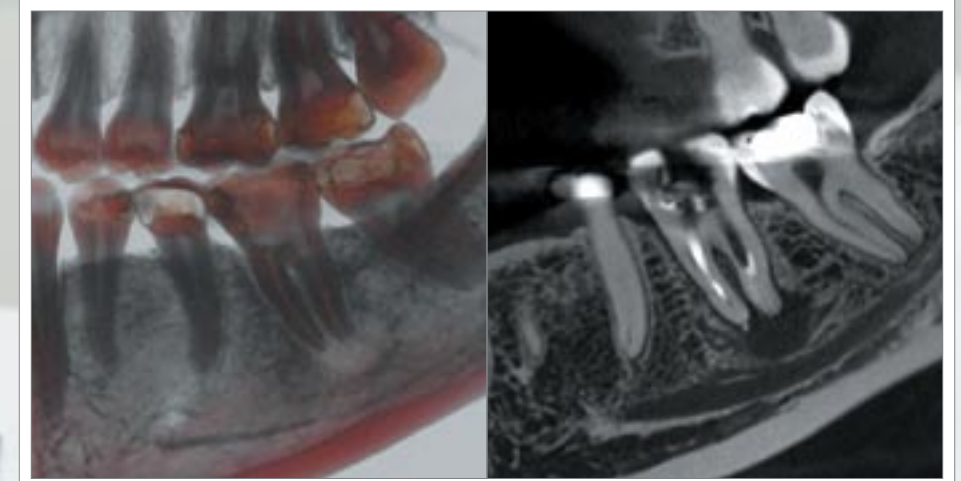

Root abscess

The cause of root abscess such as endodontic failure and implants can be accurately evaluated using the high quality images of the PreXion3D system, and assist in exact treatment planning options.



TECHNICAL DATA



PreXion

21

The World's Best Image Quality

Specifications

X-ray output	90 kV, 4mA (fixed, continuous)
Detector	FPD, 13 bits
Focal spot	0.2 mm (200 um)
Voxel size	0.147 mm (Wide mode), 0.101 mm (High-resolution mode) 512 x 512 x 512 slices
Power	120 V, Single phase, 1.5 KVA
Scan mode	217 degree rotation RAPID MODE: 8.6 sec/260 view 360 degree rotation HIGH DEF: 16.8 sec/ 512 views HIGH RES: 16.8 sec/ 512 views ULTRA HIGH DEF: 33.5 sec/ 1024 views
FOV (diameter by height)	RAPID, HIGH DEF & ULTRA HIGH DEF MODES: 81mm X 75mm/3.18" X 2.95" HIGH RES MODE: 56mm X 52mm/2.2" X 2.04"



Dimensions

CT Scanner

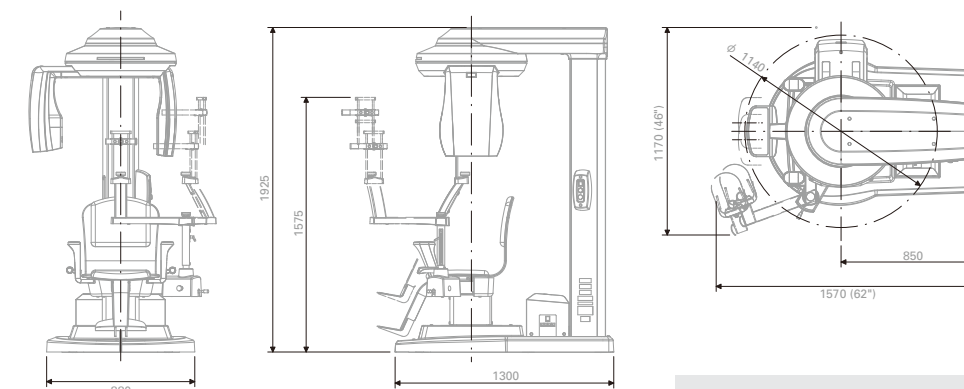

CT Scanner size:
46" (1170 mm) x 62" (1570 mm) x 76" (1925 mm)

Console PC

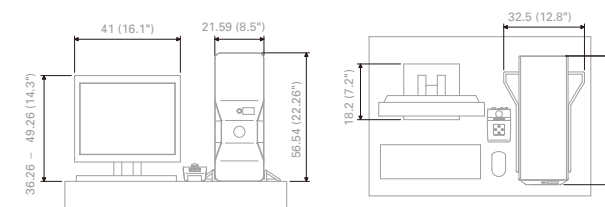

Monitor size:
16.1 in x 7.2 in x 14.3 in
(41 cm x 18.2 cm x 36.26 cm - 49.26 cm)

Workstation size (T3500):
6.8" x 17.6" x 18.4"
(17.2 x 44.7 x 46.8cm)



USA

PreXion, Inc.

411 Borel Avenue, Suite 550,
San Mateo CA 94403, USA
Tel:650-212-0300 Fax:650-212-0310
E-mail:info@prexion.com
<http://www.prexion.com>

Japan

PreXion Co., Ltd.

1-12-3-4F Kanda Suda-Cho, Chiyoda-ku Tokyo,
101-0041 Japan
Tel:+81-3-5297-2822 Fax:+81-3-5297-7552
E-mail:info@prexion.co.jp
<http://www.prexion.com>