

# 2D imaging

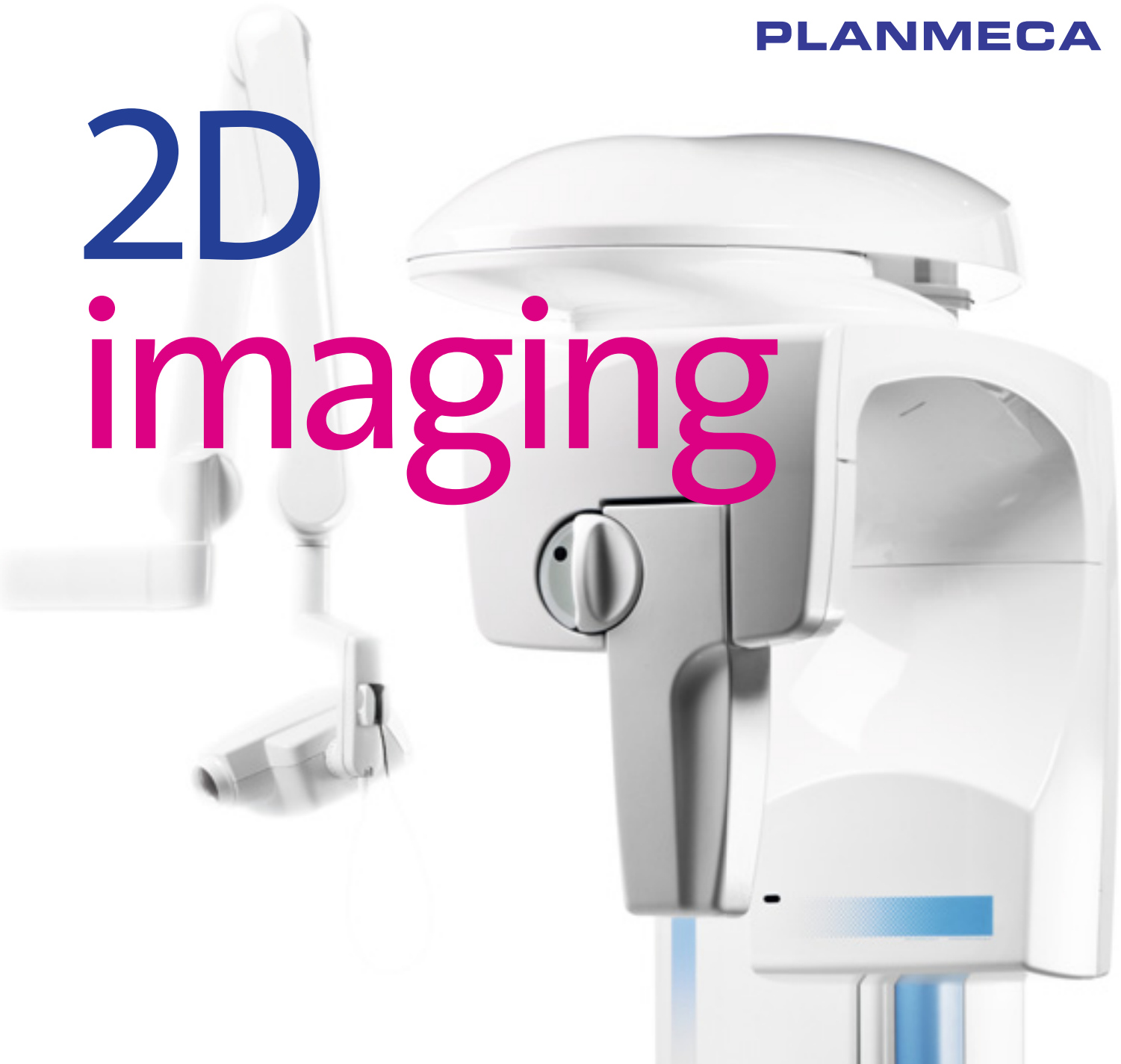

# Welcome

## An introduction from our President

Industry-leading 2D X-ray units .....	4
A new benchmark for extraoral imaging .....	6
<b>Planmeca ProMax® 2D</b> .....	8
Perfect panoramic images – every time.....	10
Effortless and comfortable.....	12
Robotic arm technology.....	14
All the imaging programs you need .....	16
Extraoral bitewings .....	18
New opportunities for tomography .....	20
Quality cephalometry for orthodontics .....	22
Easy upgrade from 2D to 3D.....	24
<b>Planmeca ProOne®</b> .....	26
Optimal imaging programs .....	28
Intraoral imaging .....	30
<b>Planmeca ProX™</b> .....	32
<b>Planmeca ProSensor® HD</b> .....	34
<b>Planmeca ProScanner®</b> .....	36
<b>Planmeca Romexis® – one software for all your needs</b> .....	38
High-performance 2D imaging.....	40
Access to unique X-ray device data .....	42
Your mobile world of imaging.....	43
Share images and expertise online.....	44
Technical specifications .....	46



“It’s my great pleasure to introduce you to our pioneering 2D X-ray units. Our comprehensive range of digital units meets all your daily imaging needs – working perfectly with our highly advanced **Planmeca Romexis®** software for the most detailed extraoral and intraoral examinations possible.

I’m extremely proud of our product innovations, and for over 40 years we’ve worked closely with dental professionals to set new standards in our field. What makes us a bit different is that all core product development and manufacturing takes place in Finland – ensuring exceptional quality and unmatched attention to detail at every stage of the process.

And we also have a dedicated team of R&D professionals behind the scenes, developing breakthrough innovations that make a real difference. Our robotic SCARA technology, for example, offers flexible, precise and complex movements needed for extraoral maxillofacial imaging. Our **Planmeca ProMax® 2D** X-ray units are all 3D-ready, which means you can easily upgrade at a later point. Therefore I’m thrilled to invite you to discover our world of 2D imaging.”

*Heikki Kyösti  
President and founder  
Planmeca Group*

# Industry-leading 2D X-ray units

Mac and Windows compatible

*Introducing our world-class range of 2D X-ray units  
– offering the most advanced and versatile devices and software  
to meet all your 2D extraoral and intraoral imaging needs.*



Planmeca ProOne®



Planmeca ProX™

Planmeca ProSensor® HD

Planmeca ProScanner®

Planmeca ProMax® 2D

# A new benchmark for extraoral imaging

*Planmeca extraoral units offer two alternative solutions to maxillofacial imaging. **Planmeca ProMax**® – the complete imaging centre – sets a new benchmark in panoramic and cephalometric imaging. **Planmeca ProOne**® is designed with simplicity in mind. It is a compact and easy-to-use panoramic X-ray unit that's both cost-effective and flexible.*



# Planmeca ProMax<sup>®</sup> 2D



*Planmeca ProMax<sup>®</sup> is a complete maxillofacial imaging system. The design and operation principles are based on the latest scientific research, technological innovations and the most demanding needs of modern-day radiology.*

## Key features:

### Advanced technology

- **Autofocus\*** positions the focal layer automatically for perfect panoramic images
- **Dynamic Exposure Control (DEC)** measures the patient's radiation transparency and automatically adjusts exposure values
- Patented **SCARA** (Selectively Compliant Articulated Robot Arm) technology guarantees an anatomically accurate imaging geometry for clear, error-free images
- Easy upgrades – add cephalostat or 3D imaging capability at any time

### Effortless use

- Full-view patient positioning with triple-laser patient positioning lights
- Side entry for comfortable access
- Easy-to-use graphical interface
- **ProTouch™ Desktop** for remote control panel operation on the imaging workstation
- Versatile **Planmeca Romexis<sup>®</sup>** 2D imaging software
- TWAIN support and full DICOM compliance

\* Available in Planmeca ProMax 2D S3

# Perfect panoramic images – every time

**Imagine** if your X-ray unit could recognise your patient's anatomy

The unique **Autofocus** feature automatically positions the focal layer using a low-dose scout image of the patient's central incisors. It uses landmarks in the patient's anatomy to calculate placement, enabling practically error-free patient positioning and dramatically reducing the need for retakes. The result is a perfect panoramic image.

Our unique Autofocus for SCARA3 units

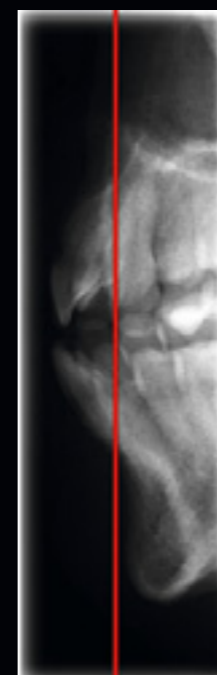
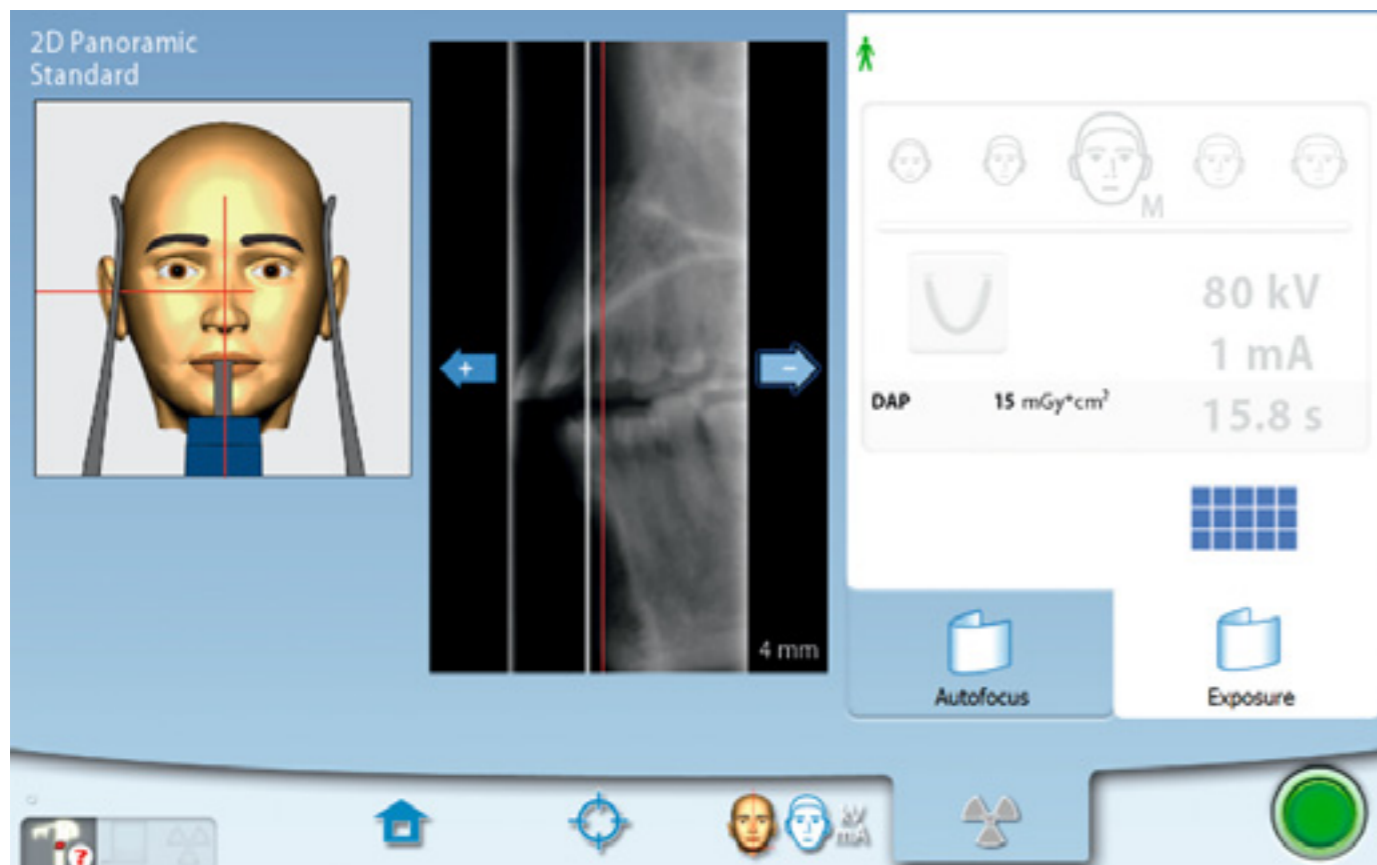

Positioning errors are now a thing of the past – with SCARA technology you can take an ultra-low-dose scout image of your patient's central incisors for a fast diagnostic panoramic image every time.

# Effortless and comfortable

Our industry-leading **Planmeca ProMax®** unit is known across the world for incredible ease of use and exceptional patient comfort. A relaxed patient means a smooth imaging workflow and the best possible image quality.

## Open patient positioning

- Position patients effortlessly thanks to open-face architecture
- Correct patient positioning either with Autofocus or manually
- Make fine adjustments using positioning lasers and joystick
- Work with an unrestricted view of your patient
- Avoid claustrophobic feelings in patients
- Accommodate wheelchairs easily with side-entry access

## User-friendly control panel

- Clear and straightforward graphical user interface guides you smoothly through your work
- Pre-programmed sites and exposure values for different image types and targets save you time and allow you to focus on your patients
- The control panel can also be operated remotely from the imaging workstation

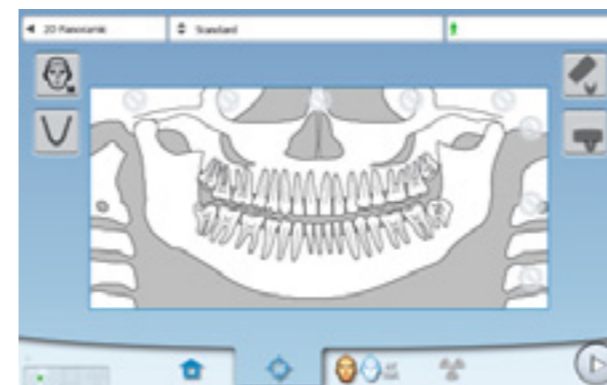

## Laser-assisted patient alignment

- A triple laser beam system accurately indicates the correct anatomical alignment points for patient positioning
- The midsagittal plane positioning beam indicates the correct sideways alignment
- The Frankfort horizontal plane positioning beam shows the correct forward tilt of your patient's head
- The focal layer positioning beam indicates the focal layer position and ensures images are sharp and clear
- Fine adjustments can be made using the joystick

## Improved image quality with Dynamic Exposure Control (DEC)

The unique digital Dynamic Exposure Control (DEC) automatically adjusts the exposure values for each individual patient based on their anatomic structure and bone density. DEC improves the quality of both panoramic and cephalometric imaging with more consistent brightness and contrast.

## Adjustable focal layer

Developed based on scientific research, the imaging geometry matches the shape of the focal layer with the patient's anatomy, resulting in clear panoramic radiographs. Simply select the shape of the focal layer on the graphical user interface, according to the size and shape of the patient's jaw.



# Robotic arm technology

**Planmeca ProMax®** features highly advanced and exclusive robotic SCARA (Selectively Compliant Articulated Robot Arm) technology – providing flexible, precise and complex movements required for rotational maxillofacial imaging.

### Unlimited movement range

Our revolutionary SCARA technology combines an electro-mechanical construction with real-time computation of dynamic rotation patterns. This enables optimised radiography for each individual patient, meeting virtually any diagnostic requirement for maxillofacial dentistry.

### User benefits for SCARA

The precise free-flowing arm movements allow for a wider variety of imaging programs not possible with other X-ray units with fixed rotations. SCARA offers superior imaging capabilities for both existing and future technologies.

## Different models for different needs

### Planmeca ProMax® 2D S3

The three-joint model (SCARA3) **Planmeca ProMax® 2D S3** has been designed for all imaging needs: panoramic, true extraoral bitewing, TMJ, sinus and 2D tomography.

### Planmeca ProMax® 2D S2

The two-joint model (SCARA2) **Planmeca ProMax® 2D S2** includes basic programs for panoramic, extraoral bitewing, TMJ and sinus imaging.

Both models can be easily upgraded to 3D imaging.



### Imaging programs

	Planmeca ProMax 2D S3	Planmeca ProMax 2D S2
<i>Standard:</i> Basic panoramic programs	Standard panoramic Lateral TMJ (closed & open) PA TMJ (closed & open) PA sinus	Standard panoramic Lateral TMJ (closed & open) PA TMJ (closed & open) PA sinus
<i>Standard</i>	Child (Paediatric) mode for each standard and optional program to reduce the dose	Child (Paediatric) mode for each standard and optional program to reduce the dose
<i>Optional</i>	Horizontal and vertical segmenting for panoramic program	Horizontal and vertical segmenting for panoramic program
<i>Optional</i>	True Bitewing	Bitewing
<i>Optional:</i> Advanced panoramic programs	Interproximal panoramic Orthogonal (perio) panoramic Lateral-PA TMJ Lateral multiangle TMJ PA multiangle TMJ PA linear sinus Lateral sinus	
<i>Optional:</i> Tomography programs	Digital linear tomography	



# All the imaging programs *you need*



Standard Panoramic



Horizontal and vertical segmenting

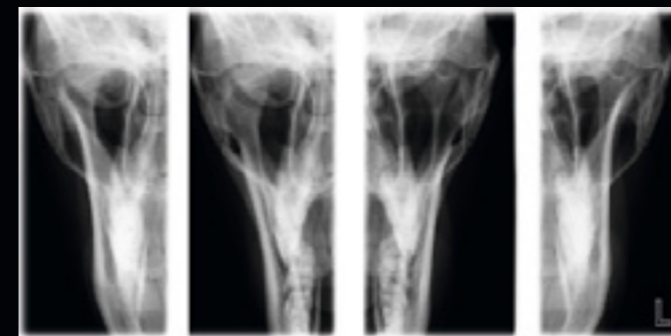

PA TMJ (closed & open)

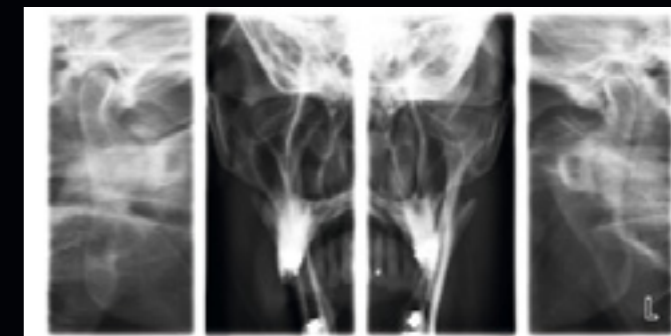

Lateral-PA TMJ

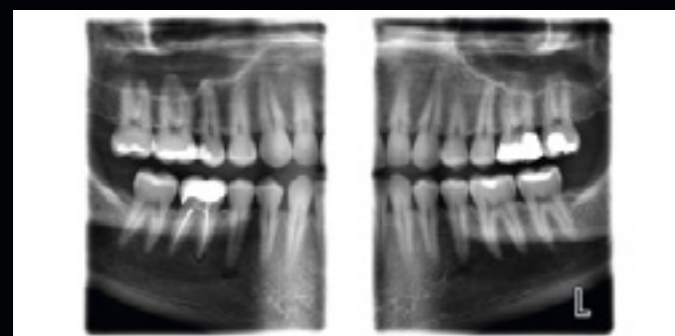

True Bitewing



Horizontal and vertical segmenting

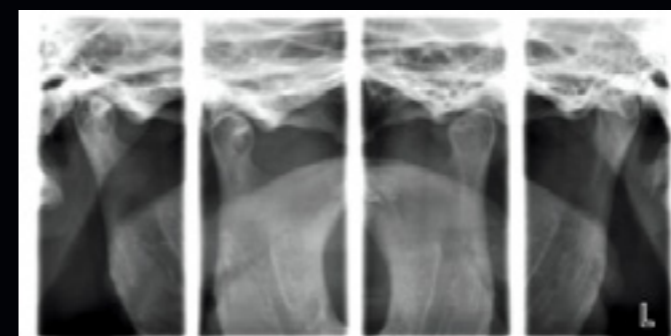

Lateral TMJ (closed & open)

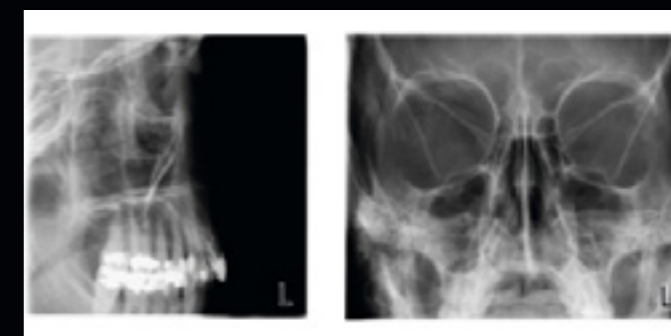

Lateral sinus and PA linear sinus

Our **Planmeca ProMax®** X-ray unit offers the widest variety of imaging programs available – easily meeting all your clinical needs.

### Panoramic imaging

In addition to the Standard panoramic program, the following programs are offered:

- Interproximal panoramic program: generates an image, where interproximal teeth contacts are open. Primarily used for caries detection.
- Orthogonal panoramic program: produces an image with clearly visible alveolar crest for improved diagnostics. Ideal for periodontal imaging and implant planning.

### Extraoral bitewings

The Bitewing program uses improved interproximal angulation geometry. The result is a bitewing image pair with low patient dose and excellent diagnostic quality.

### Horizontal and vertical segmenting for panoramic program

With the Horizontal and vertical segmenting program, exposure can be strictly limited to the diagnostic region of interest. Patient dosage is reduced by up to 90% compared to full panoramic exposure.

### TMJ imaging

The TMJ imaging programs produce lateral or posteroanterior views of open or closed temporomandibular joints. The imaging angle and position can be adjusted to correspond to the anatomy of each individual patient.

The Lateral-PA TMJ program captures lateral and PA views on the same radiograph. The multi-angle TMJ programs produce radiographs with images from three different angles, from either the lateral or PA view.

### Sinus imaging

The Sinus programs provide a clear view of the maxillary sinuses.



### Child mode for reduced dose

Child mode reduces the patient dose remarkably for all programs by reducing the imaging area and exposure values. In the panoramic program the focal layer can also be narrowed.

# Extraoral bitewings

What if you could do all your routine diagnostic imaging extraorally?

*Planmeca ProMax® extraoral bitewings are ideal for periodontics, elderly and child patients, claustrophobic patients, patients with a strong gag reflex, and patients in pain. Extraoral bitewings enhance clinical efficiency and take less time and effort than conventional intraoral bitewing imaging.*



## What are the advantages of extraoral bitewings?

- Ideal for all patients – no sensor positioning required
- Consistently opens interproximal contacts, giving better diagnostic value
- Larger diagnostic area than in intraoral modalities
- More clinical data: canine to third molar
- Enhanced clinical efficiency – takes less time and effort than conventional intraoral bitewings
- Enhanced patient experience and comfort – eliminates gagging

Better diagnostic value with extraoral bitewings

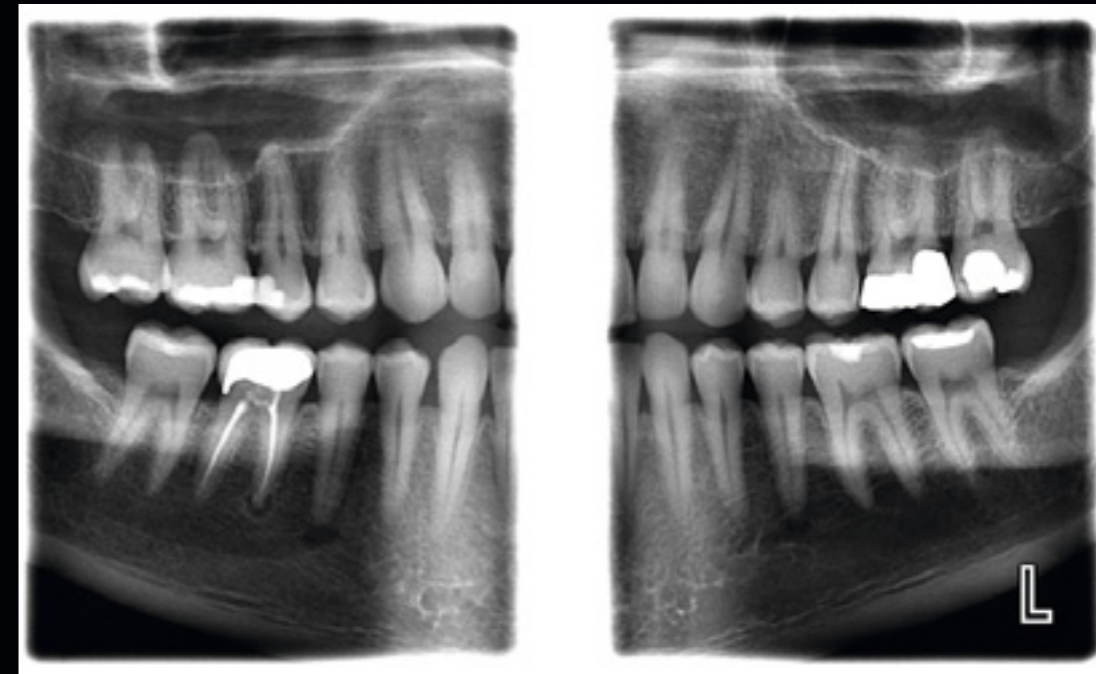

True Bitewing program, adult

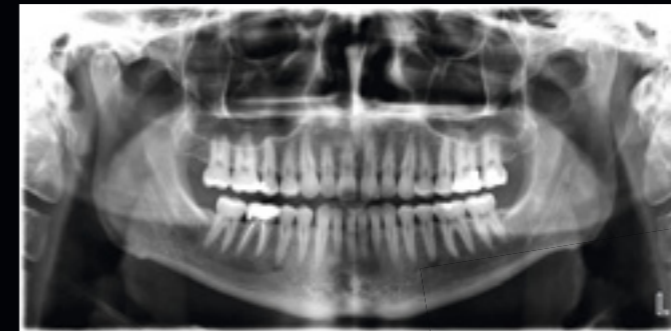

Standard panoramic image of the same patient as the bitewing above

True bitewings only possible with our SCARA3 technology

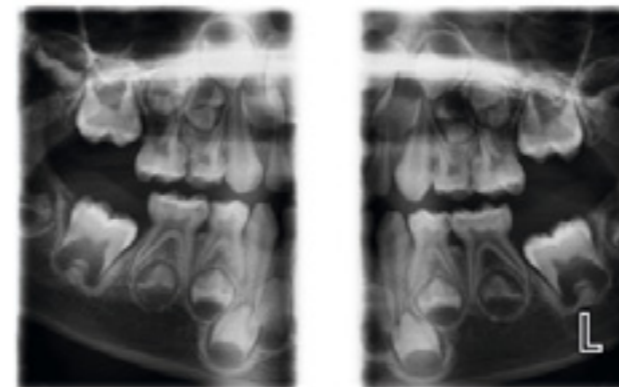

True Bitewing program, 5-year-old child

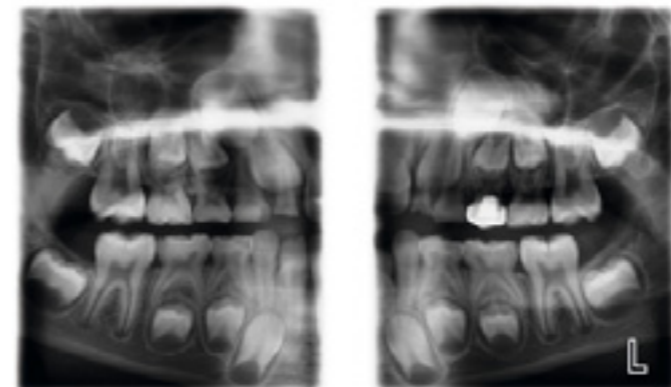

True Bitewing program, 8-year-old child



# New opportunities for tomography

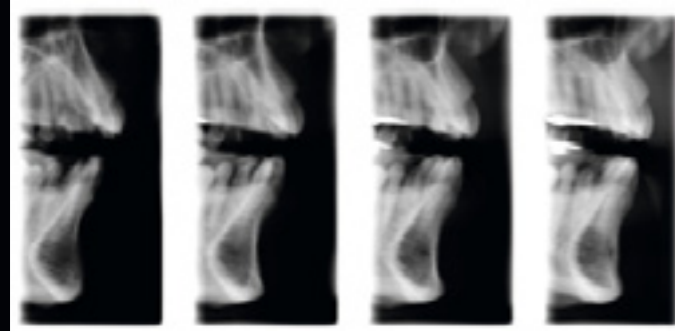

Cross-sectional tomography

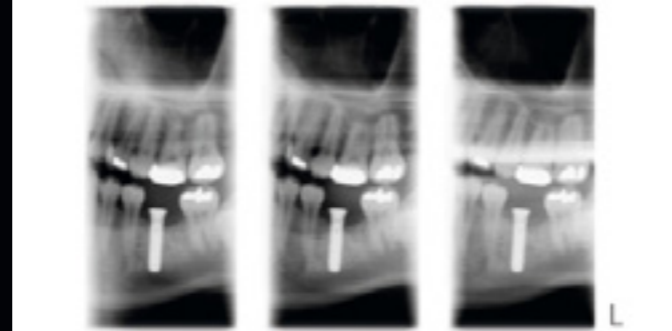

Longitudinal tomography

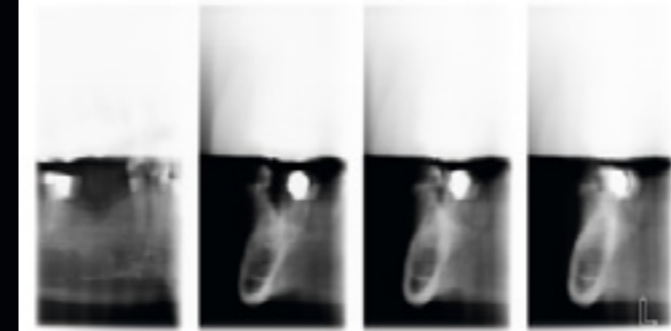

Combined tomography

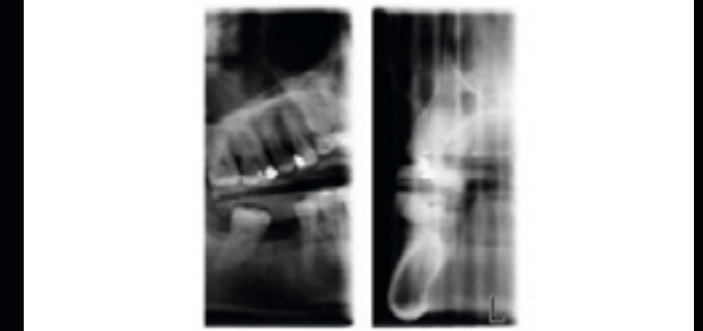

Combined tomography

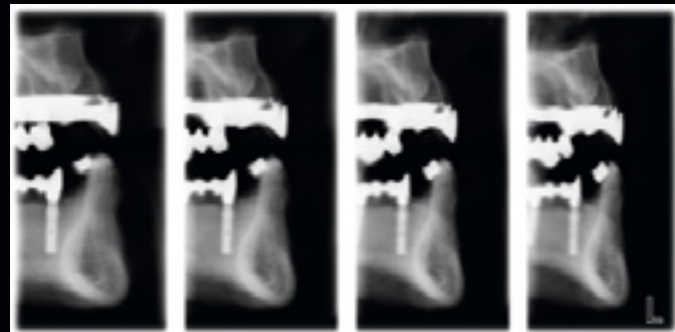

Cross-sectional tomography

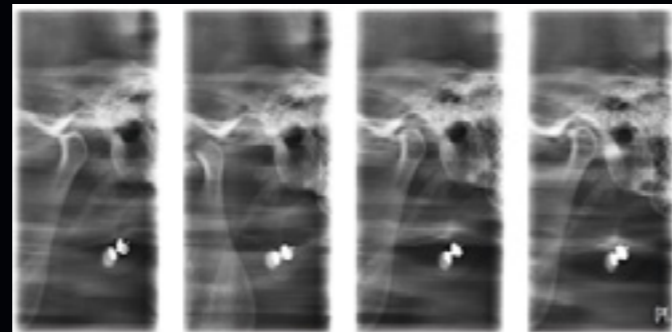

Longitudinal tomography



Combined tomography

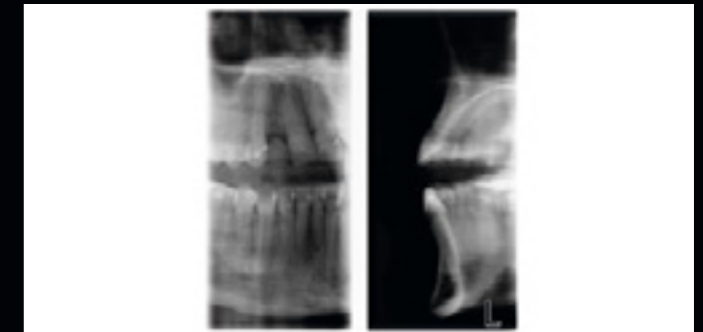

Combined tomography

*Planmeca ProMax® 2D tomography programs provide accurate tomographic information for the analysis, planning and follow-up of implant and surgical procedures.*

### Valuable tool for implantology

The Planmeca ProMax® tomography system produces clear tomographic slices of any part of the maxilla, mandible, or temporomandibular joints. The cross-sectional or longitudinal tomographs can be adjusted to any specific angle, and the constant 1.5x magnification factor and combination programs enable accurate measurements.

### Accurate automated tomography

The position and angle of the tomographic exposure is automatically pre-adjusted according to program and target selection. An impression model of the patient's dental arch can be used for easy and reliable fine-alignment, which can then be carried out practically and intuitively using the positioning joystick. The dual laser beams indicate the exact site and orientation of the tomographic cut.

### Combined, cross-sectional and longitudinal tomography

The tomography programs include a wide range of manual and automatic cross-sectional and longitudinal imaging programs and their combinations.

Combined tomography is highly valuable in implant planning, integrating cross-sectional and longitudinal views on the same radiograph. Both transversal and longitudinal views show the same position in two perpendicular projections, giving three-dimensional information on the target with the same magnification.

# Quality cephalometry for orthodontics

*Our exceptional equipment and advanced software have been designed to meet all your orthodontic needs.*

## Cephalometric imaging with Planmeca ProMax® units

- The functional and easy-to-use head positioner ensures accurate positioning for all cephalometric projections
- The carbon fibre ear posts and nasal positioner are extremely stable, hygienic, and transparent to radiation
- The unit automatically aligns itself to take cephalometric exposures and then selects a corresponding collimator
- Dedicated collimation options for paediatric imaging

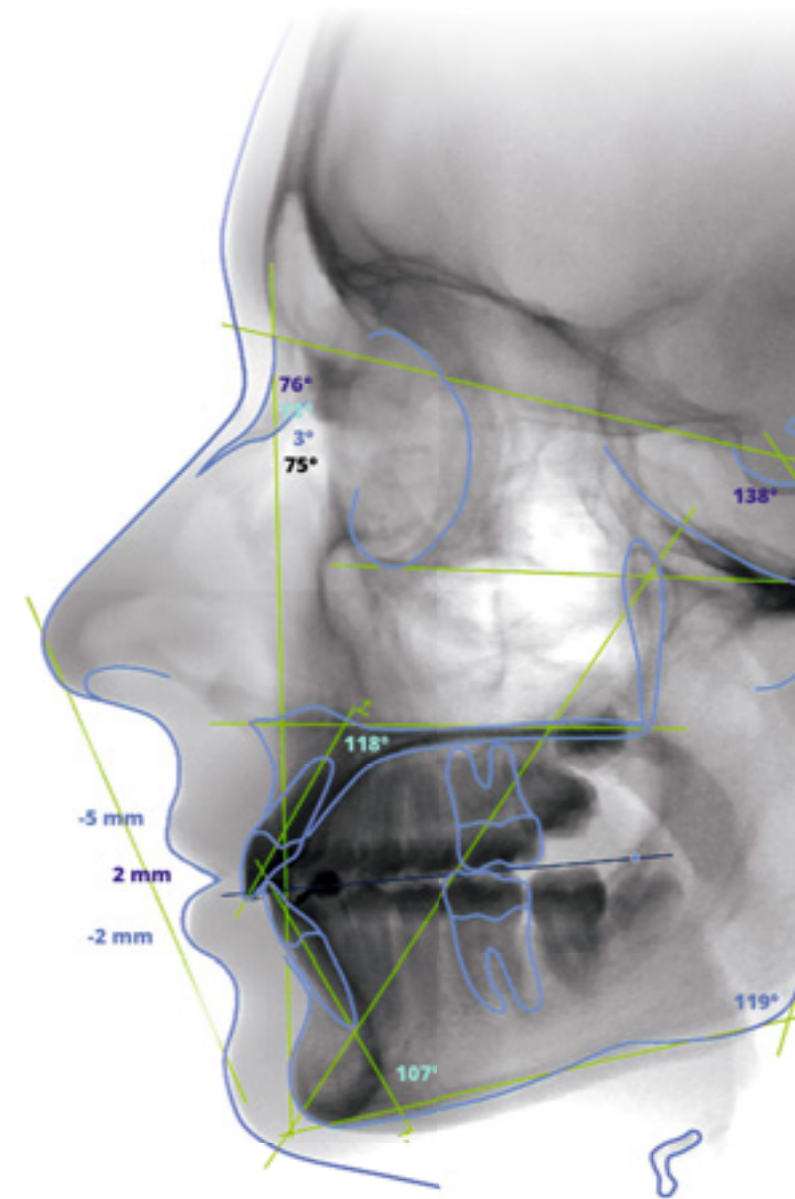

## Two equipment options:

### One-shot Planmeca ProCeph™ cephalostat

- Effective one-shot cephalostat
- Short exposure time – no motion artefacts, low patient dose
- Image sizes from 18 x 20 cm to 30 x 25 cm

### Scanning Planmeca ProMax® cephalostat

- Digital cephalostat that scans your patient's head horizontally using a narrow X-ray beam with an extremely low effective dose of radiation
- Exceptional flexibility in image formats, with field sizes of up to 30 x 27 cm

Easier and more accurate than ever before

## Two options for cephalometric analyses:

New!

### Planmeca Romexis® Cephalometric Analysis module

Take advantage of the Planmeca Romexis® Cephalometric Analysis module's wide range orthodontic and orthognathic tools.

- Tools for creating cephalometric analyses, superimpositions, and surgical treatment plans (VTO) in minutes
- Fully customisable analyses, norms, and reports
- Microsoft Excel export and import function
- Compatible with the Windows operating system

### Online automatic analysis service

Acquire cephalometric analyses regardless of time and place with the Planmeca Romexis® automatic cephalometric analysis service.

- Online automatic cephalometric tracing in a few seconds
- Over 50 analyses available for download immediately after tracing
- Direct link from the Planmeca Romexis 2D module for ordering analyses

# Easy upgrade from 2D to 3D



## Planmeca ProMax® – future proof and a great investment

Planmeca ProMax® 2D is designed with upgradeability in mind. The unit's modular structure allows easy conversion to different imaging modalities, while the software-driven SCARA is extremely flexible, allowing you to benefit from new imaging projections.

Whether you're upgrading your 2D unit to 3D, or adding a cephalometric arm, Planmeca has the right solution for you.

Individual options can be installed before delivery or added later, making Planmeca ProMax the most versatile all-in-one X-ray unit available.

2D unit  
Planmeca ProMax 2D S3

3D unit  
Planmeca ProMax 3D s

3D unit  
Planmeca ProMax 3D Classic

2D unit  
Planmeca ProMax 2D S2

2D unit  
Planmeca ProMax 2D S3

3D unit  
Planmeca ProMax 3D s

3D unit  
Planmeca ProMax 3D Classic

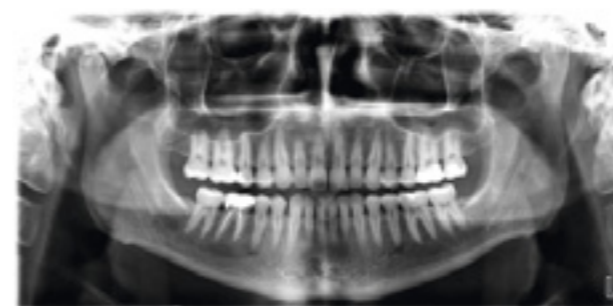

# Planmeca ProOne®



*Planmeca ProOne® is our full-featured panoramic X-ray unit, designed with simplicity in mind. Featuring cutting-edge innovations, Planmeca ProOne combines extensive diagnostic capabilities and superior image quality into a compact, easy-to-use package.*

#### Easy patient positioning

Open patient positioning and side entry minimise errors caused by incorrect patient positioning by allowing you to monitor the patient freely from both the front and side. Side entry allows easy access for all patients – standing or seated. Patient positioning is assisted by our triple laser beam system, which indicates the correct anatomical positioning points.

#### Autofocus – for perfect panoramics every time

The unique **Autofocus** feature automatically positions the focal layer using a low-dose scout image of the patient's central incisors. Landmarks in the patient's anatomy are used to calculate placement, enabling practically error-free patient positioning and dramatically reducing the need for retakes. The result is the perfect panoramic image, every time.

#### User interface provides guidance

The full-colour graphical user interface provides clear texts and symbols to guide you through your procedure. Settings are logically grouped and easy to understand, speeding up imaging and allowing you to focus on positioning your patient correctly and communicating with them.



# Optimal imaging programs



Standard panoramic

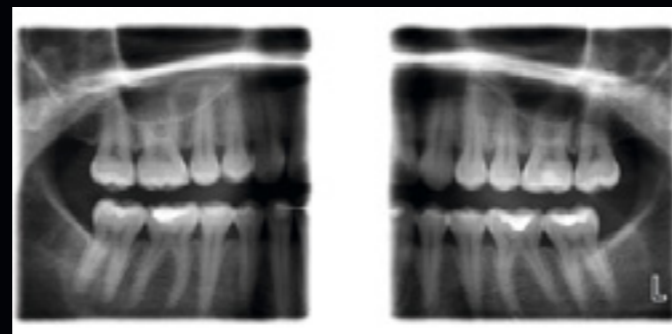

Bitewing

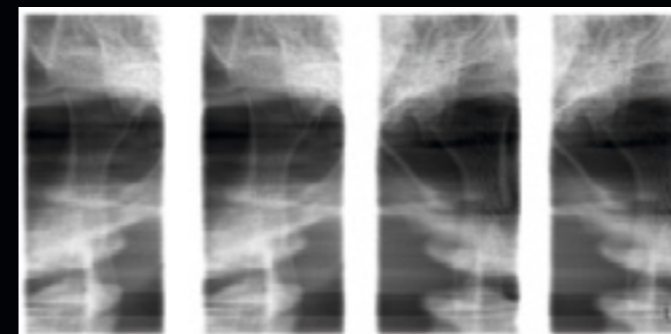

PA TMJ

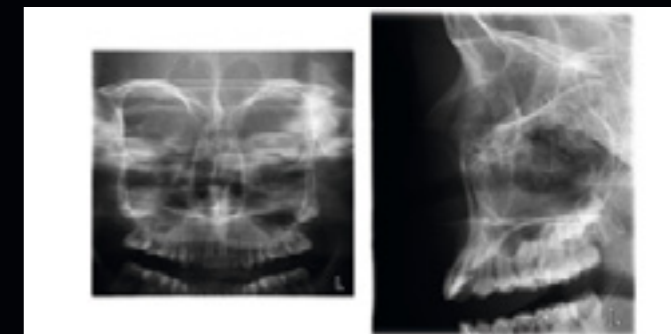

PA Sinus and Lateral non rotational sinus

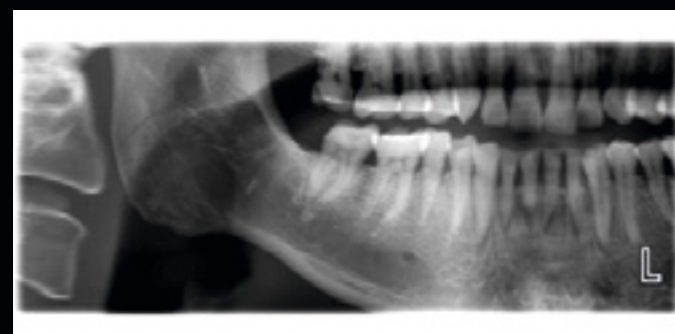

Horizontal and vertical segmenting for panoramic program



Lateral TMJ

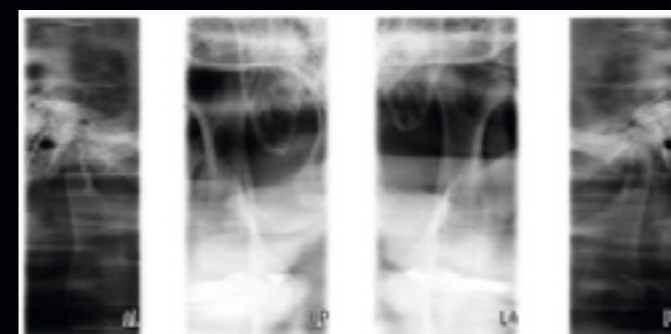

Lateral-PA TMJ

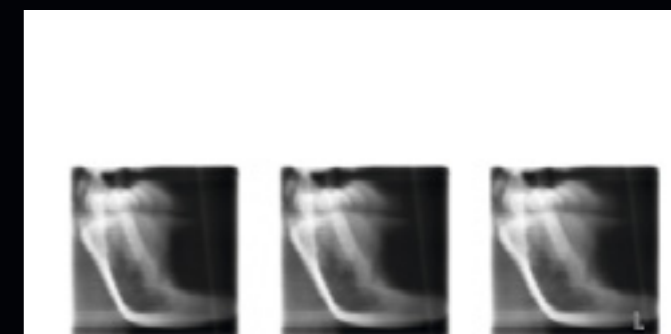

Cross-sections

*Planmeca ProOne® offers you a wide variety of imaging programs for different radiographic needs. You can also select the correct exposure formats to minimise the radiation dose for all types of patients and diagnostic purposes.*

## Imaging programs

<i>Standard:</i> Basic panoramic programs	Standard panoramic Lateral TMJ PA TMJ PA Sinus
<i>Standard</i>	Child (Paediatric) mode for each program to reduce the dose
<i>Optional</i>	Horizontal and vertical segmenting for panoramic program
<i>Optional</i>	Bitewing
<i>Optional:</i> Advanced panoramic programs	Interproximal panoramic Orthogonal (perio) panoramic Lateral-PA TMJ Lateral multiangle TMJ Lateral non rotational sinus Cross-sections Bitewing



### Child mode for optimal paediatric imaging

In child mode, the imaging area and exposure values are reduced in all programs and also the focal layer can be narrowed in the panoramic program. The patient dose is reduced remarkably.

# Intraoral imaging

Our premium **Planmeca ProX™** intraoral X-ray unit and advanced sensor system **Planmeca ProSensor® HD** combine perfectly to meet your intraoral imaging needs. The integrated system guarantees a smooth imaging workflow, while the smart design features make it effortless to use. Our full-featured **Planmeca ProScanner®** imaging plate scanner offers top-quality images and a fast scanning process to support your everyday tasks.

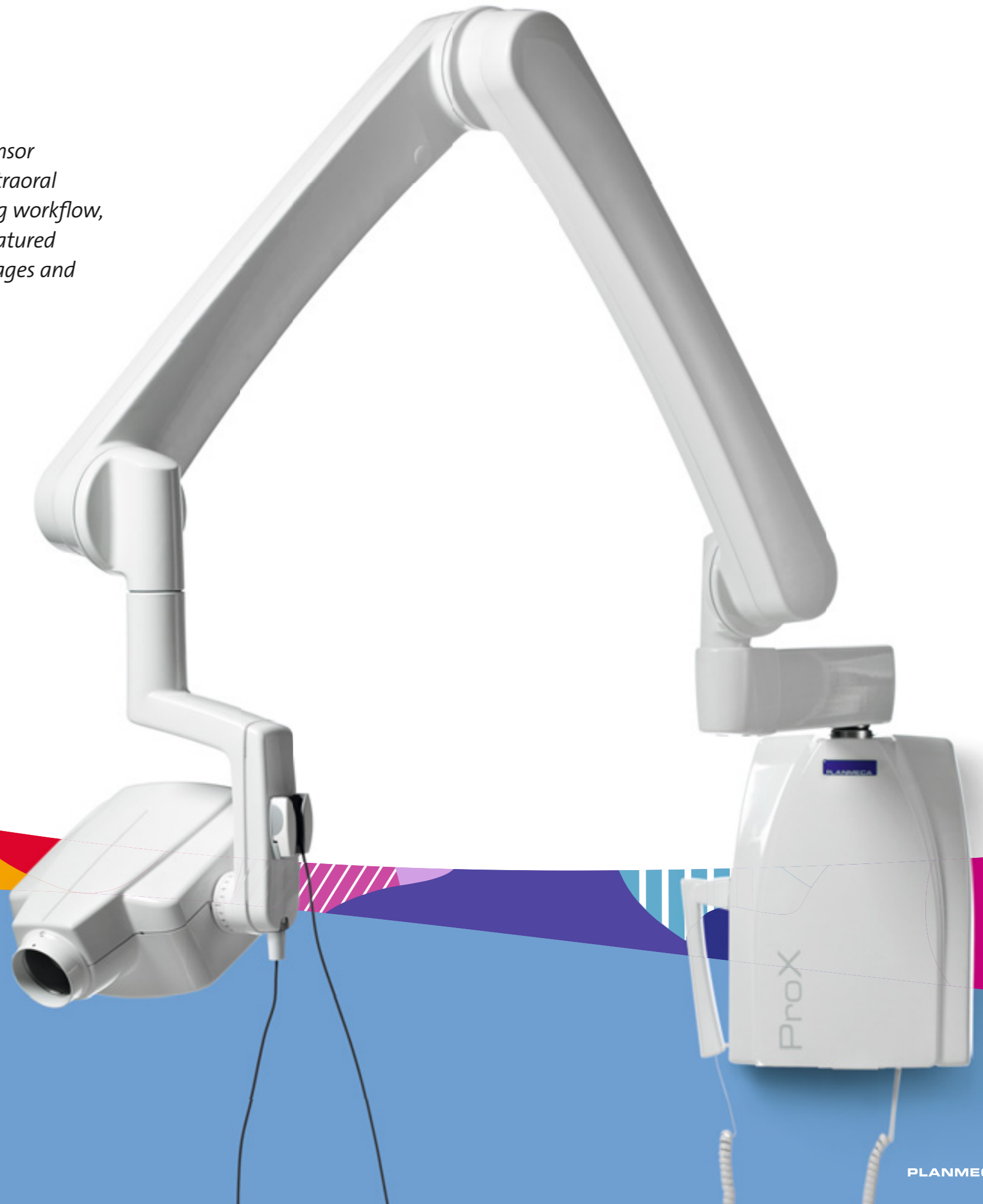



# Planmeca ProX™

We're very proud to introduce **Planmeca ProX™** – the latest intraoral X-ray unit to feature in our exceptional range of imaging products. This advanced unit provides easy and precise positioning, a straightforward imaging process and top quality images in high resolution. Planmeca ProX is uniquely designed to make intraoral imaging easier and more reliable than ever.

## The premium intraoral X-ray unit

- Optimal images for all diagnostic needs: variable kV and mA
- Quick and easy to use: pre-programmed quick settings, practical design
- Digital-ready
- Integrated with **Planmeca ProSensor® HD** sensor system
- Smooth workflow with **Planmeca Romexis®**
- Versatile installation options

## Highly adaptable imaging

**Planmeca ProX™** adapts to both short-cone and long-cone imaging techniques. For maximum radiation hygiene, an additional rectangular collimator can be adapted for the long cone.

The steady X-ray unit arm provides accurate and drift-free positioning of the lightweight tube head. The unit's flexible installation options mean it can accommodate a wide range of requirements and clinic layouts.

## Quick imaging parameter settings

Planmeca ProX comes pre-programmed with quick settings for different exposure value combinations. Imaging parameters are automatically retrieved according to the selected exposure region and the diagnostic need, and values can also be manually adjusted if necessary. Simply select the image receptor to automatically adapt the pre-programmed settings for film, imaging plate or digital sensors, allowing rapid transition to new imaging technologies without reprogramming.

## Faster X-ray examinations with digital sensor

Benefit from the ultimate in user-friendly intraoral imaging by combining Planmeca ProX with the Planmeca ProSensor HD digital sensor system. The image is displayed on the screen just seconds after exposure, significantly reducing the time needed for an intraoral X-ray examination compared to conventional film.



# Planmeca ProSensor® HD

Experience usability like never before

Our innovative **Planmeca ProSensor® HD** intraoral sensor offers a unique combination of unparalleled image quality, high-end patient-centred design, and usability. It sets a new standard for intraoral dental imaging – ensuring successful results and a smooth workflow in all treatment situations.

## Cutting-edge image quality

With a true resolution of over 20 lp/mm, **Planmeca ProSensor® HD** offers real HD image quality. Supporting detailed diagnosis, the advanced imaging sensor with a fibre-optic layer captures sharp, low-noise and high contrast images. The wide dynamic range of the sensor ensures successful results each and every time.

## Patient-centred design

To fulfill all intraoral imaging needs, Planmeca ProSensor HD is available in three different sizes. The rounded sensor edges make the procedure comfortable for patients and outstanding images are ready in a matter of seconds.

## Usability comes as a standard

Planmeca ProSensor HD is always easily at hand. It can be integrated into the **Planmeca ProX™** intraoral X-ray unit, or connected to through Ethernet or a USB port. The sensor has a sophisticated magnetic connector that is easy to attach with only one hand, while the white sensor colour enhances visibility to ease positioning. The elegant control box with a distinguished design is equipped with a colour-coded LED light, providing instant visual feedback of the imaging procedure. Hermetically sealed housing ensures effective infection control.

## Carefree choice

Planmeca ProSensor HD has been designed to last. For optimal endurance, the sensor cable has been reinforced and includes only two wires. Our special five-year warranty program ensures a safe investment for your practice.

Each layer carefully designed – for perfect results

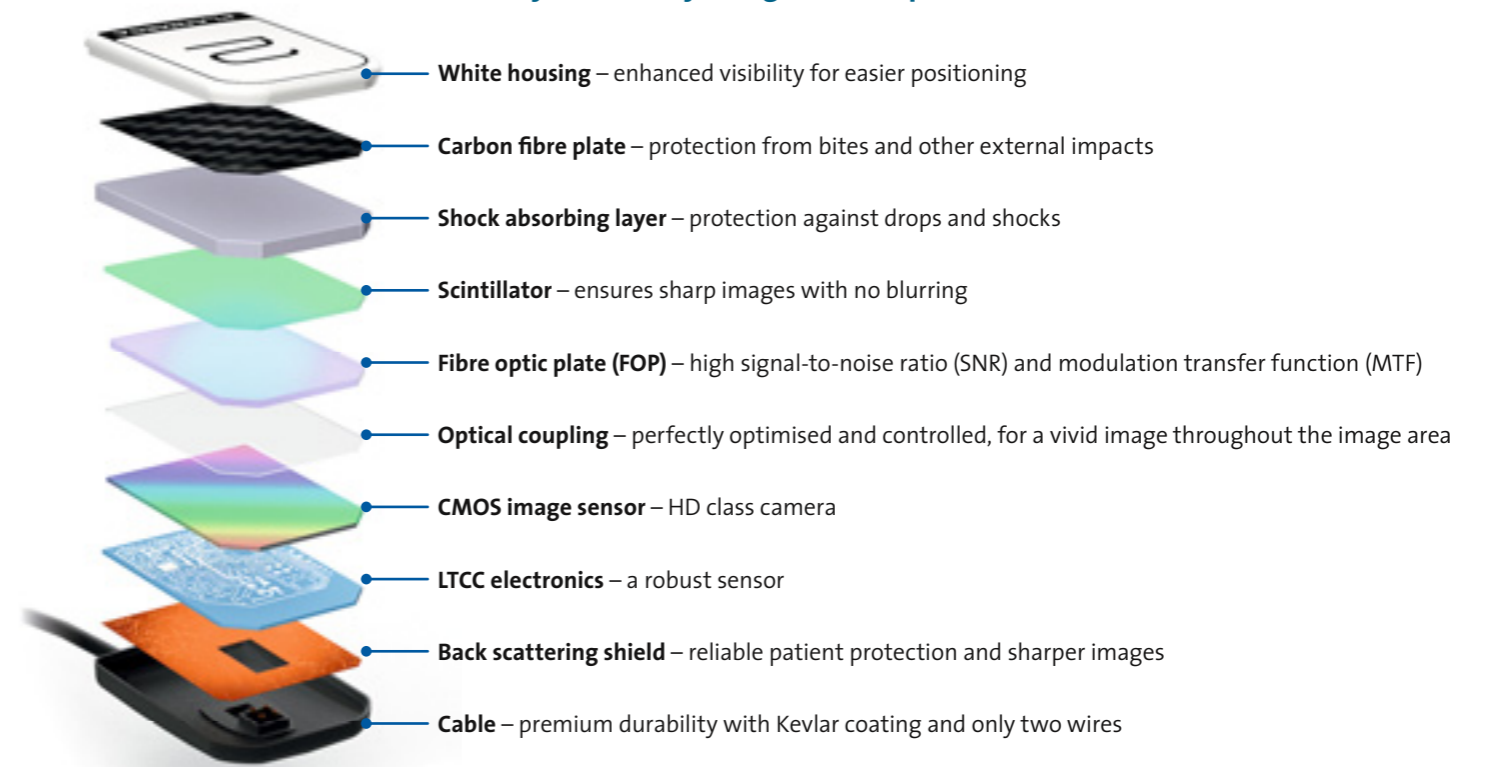

## Planmeca ProSensor® HD in a nutshell

- True resolution of over 20 lp/mm
- Sharp and low-noise images with high contrast
- Wide dynamic range
- Three sensor sizes with rounded edges
- Magnetic connector for ease of use
- Colour-coded LED light on control box for instant visual feedback
- Hermetically sealed housing ensures effective infection control
- Integration with the **Planmeca ProX™** X-ray unit
- Fully compatible with Windows and Mac
- Plug and play USB version
- Five-year warranty program – full three-year warranty + two-year warranty with 10% off of the valid net price

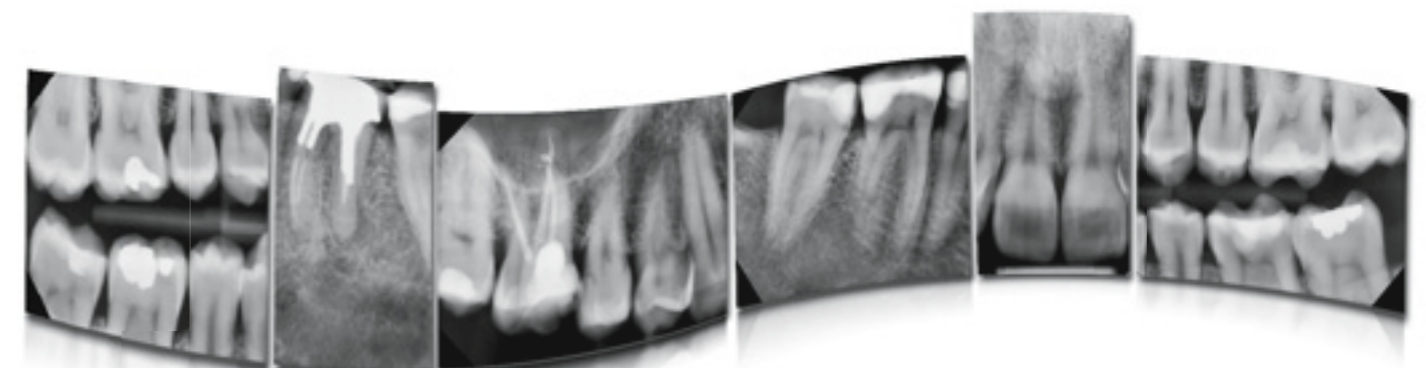

# Planmeca ProScanner®

Full-featured imaging plate scanner  
for both chairside and shared multi-room use

*A member of our advanced intraoral imaging family, the **Planmeca ProScanner®** imaging plate scanner is a powerful solution for both chairside and shared multi-room use. It supports your everyday tasks with smart design details, enabling a fast scanning process.*

## Compact and fast

Packed in a streamlined and elegant design, the compact **Planmeca ProScanner®** fits any room. It allows top-quality images to be taken in a matter of seconds. A preview image is displayed on the scanner's LCD touch screen for instant verification of the result, while the embedded eraser prepares the plates for further use. The 100 most recent images are saved on the scanner's SD card for enhanced security.

## Smart imaging plates in all sizes

Planmeca ProScanner imaging plates are durable, but also extra soft for patient comfort. They come in all imaging plate sizes – 0, 1, 2, 3, and 4c. The advanced plates are equipped with an RFID chip holding an electronic serial number. It is possible to sort, view and compare images for quality control, as well as count exposures by using the serial number of each plate in the **Planmeca Romexis®** software.

## Perfect for multi-room clinics

Planmeca ProScanner is an ideal solution for clinics of all sizes. The scanner can be shared between multiple treatment rooms with the help of its intelligent RFID chip. In shared use, the plates can be tagged to a particular workstation and patient file by reading their serial numbers in the treatment room with the **Planmeca ProID™** RFID reader. Once the images have been scanned, they are automatically sent back based on their serial number. Operator errors are eliminated, as images can be scanned in any order – even between patients – resulting in a smooth and adjustable workflow.



# Planmeca Romexis® one software for all your needs

We offer a revolutionary all-in-one software solution for clinics of all sizes. Our world-leading **Planmeca Romexis®** software is the brains behind all of our products, bringing together all the devices at your dental clinic from CAD/CAM to imaging devices and dental units. It supports the most versatile range of 2D and 3D imaging modalities.



Imaging and CAD/CAM in one software  
– an industry first

# High-performance 2D imaging

Our advanced **Planmeca Romexis®** software suite offers the most versatile tools for 2D imaging. Diagnose images using our full range of enhancement tools – or view them wherever you are with our mobile apps. This flexible dental imaging suite adapts to your needs and will grow into the third dimension together with your practice.

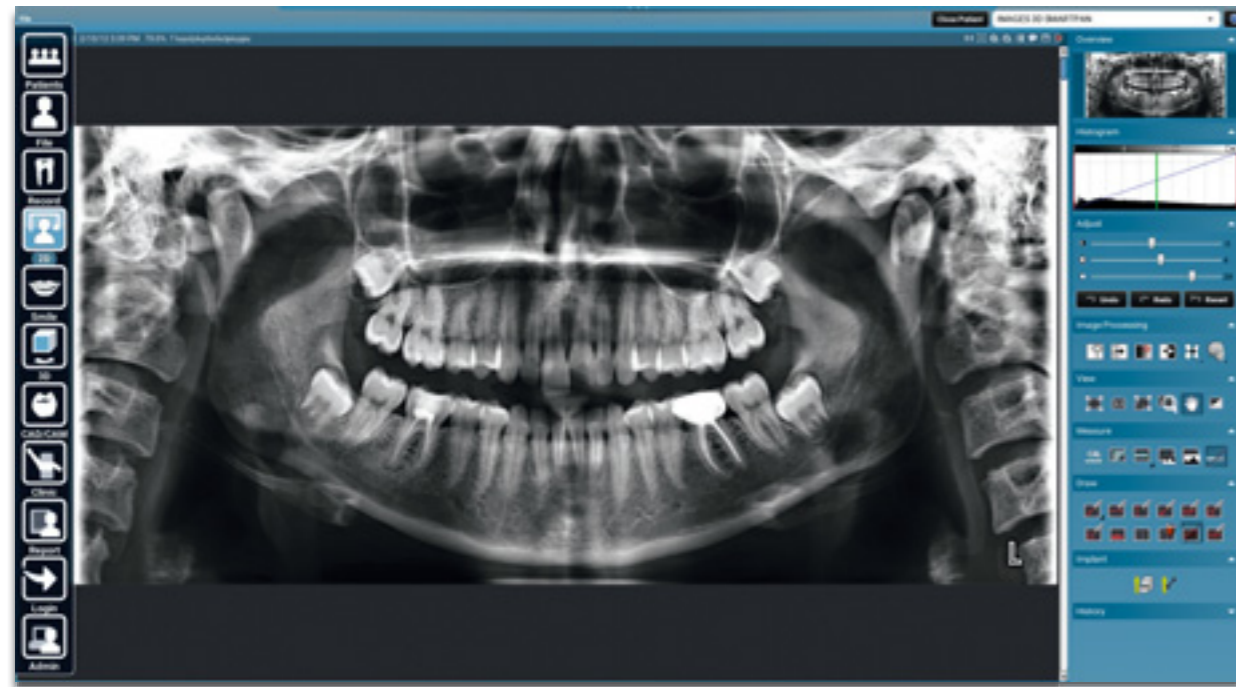

## Integrated document management

The printing module with multi-page support is ideal for creating professional, high-quality printouts and radiology reports to be sent to referring dentists.

Documents of any type can be attached to patient files, providing a convenient storage for cephalometric tracing reports, referral letters and other information.



## Advanced implant planning

Planmeca Romexis provides powerful tools for implant planning, including realistic implant models from over 60 manufacturers.

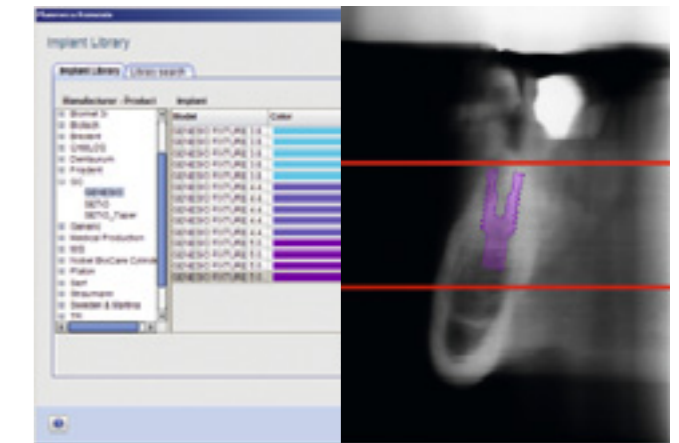

## Easy and powerful

**Planmeca Romexis®** is the software of choice for viewing and processing 2D images from Planmeca X-ray units. Powerful enhancement and analysis tools guarantee that accurate diagnosis is available to users in all specialties, while the intuitive interface guarantees confident, comfortable use from day one.

## Sharing the results

Cases can be seamlessly transferred to mobile devices or partner clinics that use Planmeca Romexis or the free **Planmeca Romexis® Viewer**. Our integration with other systems allows you to freely utilise third-party products at your clinic. TWIN support and DICOM standard compliance ensure that the software can be used together with most systems.

Free Planmeca Romexis® Viewer application  
[planmeca.com/Viewer](http://planmeca.com/Viewer)  
 Full-featured viewer application  
 No installation required  
 Mac and Windows support  
 Distribute to specialists or patients

## Radiology interpretation module

The **Planmeca Romexis® Radiological Findings** module is the most advanced findings-recording tool on the market. Developed in cooperation with clinicians, its findings list is hierarchically categorised and can be freely edited. The module is especially designed for educational and radiology centres where uniformity of recordings is essential.

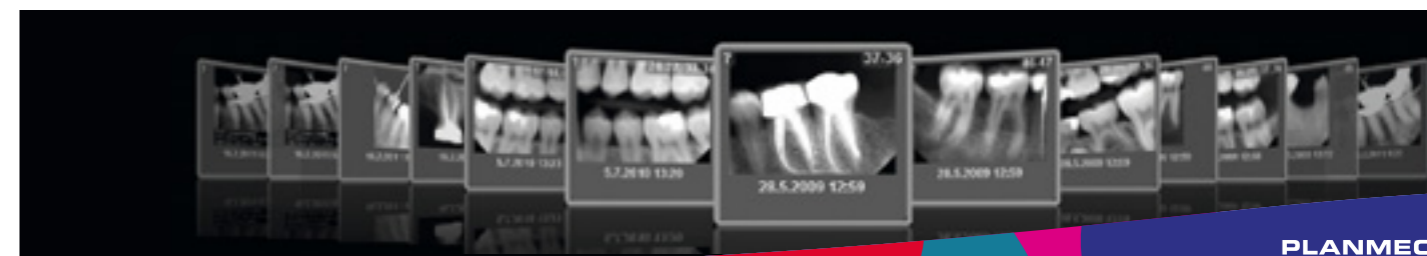
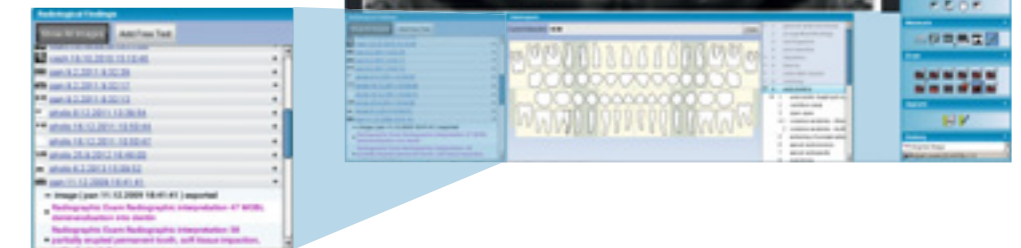

# Access to unique X-ray device data

Our **Planmeca Romexis® Clinic Management** software module provides valuable and reliable equipment usage data. It is an ideal solution for all – from smaller private practices to large multi-site clinics.

All Planmeca X-ray units can be connected to the **Planmeca Romexis® Clinic Management** software module. The module collects information on the number and type of taken images and provides data from different units for reporting, improving clinic efficiency, and planning new investments.

Planmeca Romexis Clinic Management helps users stay on top of clinic operations with real-time information on Planmeca X-ray units and their status. Detailed equipment information – such as software versions, calibration dates, and history logs – ensures high-quality service and patient care at all times.

Web-based reporting – view device status and usage dashboards from anywhere



# Your mobile world of imaging

Our advanced **Planmeca mRomexis™** imaging application for iOS and Android allows you to flexibly view and capture images on mobile tablet devices. Remove the constraint of place – easily consult with colleagues and communicate with patients both in and outside your clinic.

## Increased flexibility with Planmeca mRomexis™

Use our fast, easy, and light **Planmeca mRomexis™** mobile imaging application to view all your images in the **Planmeca Romexis®** database on a local network, or to carry images with you on your tablet device. You can also use the application to capture 2D X-ray images with Planmeca equipment, or to take photos with the tablet camera.

Expand the possibilities of Planmeca Romexis and experience the new level of freedom our mobile world can offer!



For iOS and Android

### Key benefits:

- Available for both iOS and Android tablets
- Supports an extensive range of images – 2D and 3D X-ray images, 3D dental models, STL files, **Planmeca ProFace®** facial photos, and standard photos
- Direct connectivity with the **Planmeca Romexis®** server for retrieving or saving images
- Convenient acquisition of 2D X-ray images with Planmeca equipment
- Capturing photos with the camera of the mobile device
- Voice annotations to images can be recorded using the mobile device's microphone
- Flexible and secure retrieving of images via the **Planmeca Romexis® Cloud** image transfer service
- Excellent tool for patient education and communication



Download the **Planmeca mRomexis™** application for iOS and Android from the App Store or Google Play.



# Share images and expertise online

*Planmeca Romexis® Cloud is a secure image transfer service for Planmeca Romexis® users and their partners. Now you can easily share images and CAD/CAM cases with any specialist or patient.*



### Planmeca Romexis® user

- Radiology center
- General practice

## Planmeca Romexis® Cloud

- IMAGES
- REFERRALS
- INTERPRETATIONS
- TREATMENT PLANS

### Anybody, anywhere

- General practitioner
- Colleague
- Radiologist
- Specialist
- Dental lab
- Patient



### Advantages

- Seamlessly integrated into **Planmeca Romexis®** ensuring an efficient workflow – no need for external applications or CDs and DVDs
- Automatic delivery of images and attachments
- Automatic notification to recipient of new cases

- Cases can be sent to any recipient who has an e-mail account
- Secure transfer and storage of information
- Streamline your communication with **Planmeca Romexis® Cloud**

### Features

#### Sending images to recipient

- 2D images: panoramic, cephalometric, photos, intraoral X-ray images
- 3D images: CBCT, 3D photos, surface scans
- All annotations and other elements are included

#### Sending documents to recipient

- Attach one or more referrals, reports, or other documents

### Versatile possibilities for communication

#### Recipients can download and view images at no cost using:

- Planmeca Romexis
- **Planmeca mRomexis™** imaging application for iOS and Android devices
- Free **Planmeca Romexis® Viewer**

**Planmeca Romexis® software and Planmeca Romexis® Cloud subscription are required for sending new cases. Visit <http://online.planmeca.com/> to subscribe and start sending images now.**

# Technical specifications

## Technical data

Generator	Constant potential, resonance mode high frequency 80-150 kHz	
X-ray tube	D-054SB-P	
Focal spot size	0.5 x 0.5 mm (IEC 336)	
Total filtration	min. 2.5 mm Al equivalent	
Anode voltage	50-84 kV	
Anode current	0.5-16 mA DC	
Exposure time	Pan	2.7-16 s
	Scanning ceph	6.4-9.9 s
	ProCeph	0.1-0.8 s
	Tomo	3 s / frame
SID	Pan	500 mm (19 in.)
	Ceph	170 cm (67 in.)
Magnification	Pan	constant 1.2
	Ceph	1.08-1.13
CCD pixel size	48 µm	
Image pixel size	48/96/144 µm selectable	
CCD active surface	Pan	6 x 147 mm
	Ceph	6 x 295 mm
Resolution (digital)	Pan	max. 9 lp/mm
	Ceph	max. 5.7 lp/mm
Image field (digital)	Pan	14 x 30 cm (5.5 x 12 in.)
	Ceph	24/27 x 18/30 cm (9/10.6 x 7/11.8 in.)
File size, uncompressed (digital)	Pan	4-33 MB
	Ceph	7-16 MB
Line voltage	100-240 V, 50 or 60 Hz	
Regulation	Automatic, ±10 %	
Line current	8-16 A	
Colour	White (RAL 9016)	

## Imaging programs

	Planmeca ProMax 2D S3	Planmeca ProMax 2D S2
<i>Standard:</i> Basic panoramic programs	Standard panoramic Lateral TMJ (closed & open) PA TMJ (closed & open) PA sinus	Standard panoramic Lateral TMJ (closed & open) PA TMJ (closed & open) PA sinus
<i>Standard</i>	Child (Paediatric) mode for each standard and optional program to reduce the dose	Child (Paediatric) mode for each standard and optional program to reduce the dose
<i>Optional</i>	Horizontal and vertical segmenting for panoramic program	Horizontal and vertical segmenting for panoramic program
<i>Optional</i>	True Bitewing	Bitewing
<i>Optional:</i> Advanced panoramic programs	Interproximal panoramic Orthogonal (perio) panoramic Lateral-PA TMJ Lateral multiangle TMJ PA multiangle TMJ PA linear sinus Lateral sinus	
<i>Optional:</i> Tomography programs	Digital linear tomography	

## Dimensions

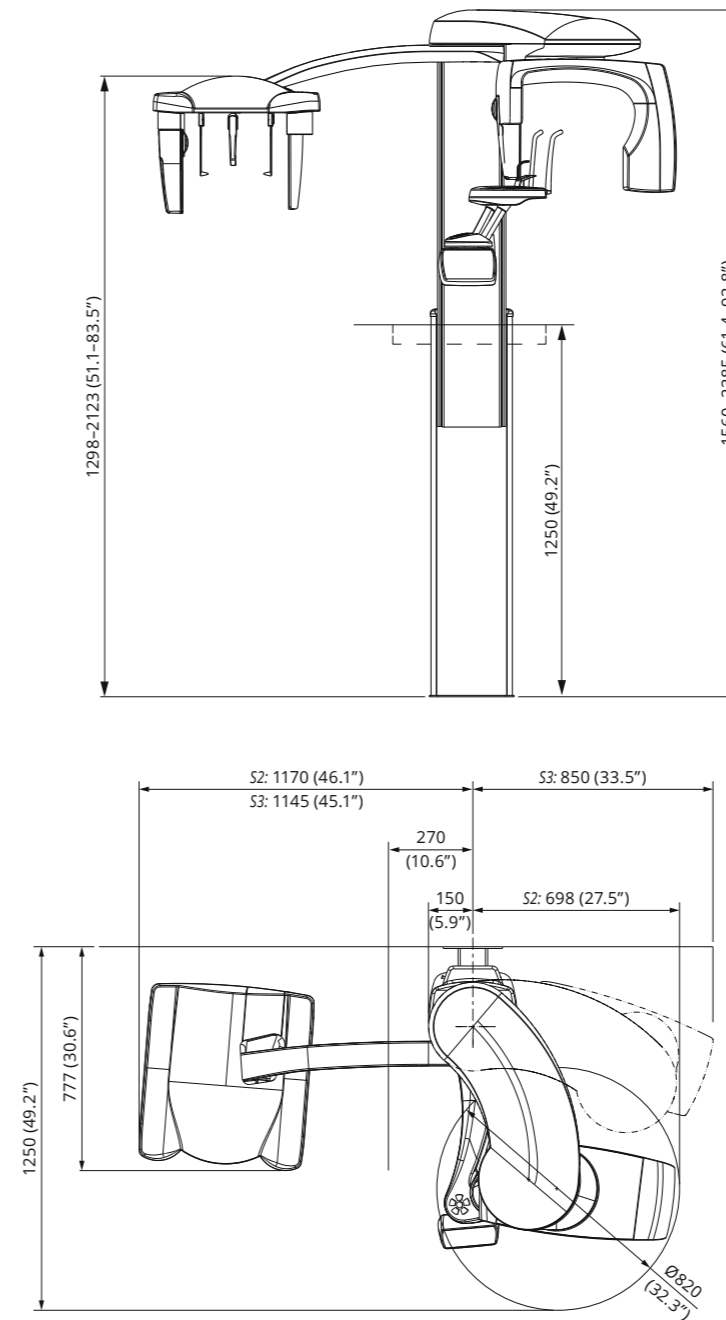

## Physical space requirements

	Planmeca ProMax 2D	Planmeca ProMax 2D with cephalostat
Width	96 cm (38 in.)	194 cm (76 in.)
Depth	125 cm (49 in.)	125 cm (49 in.)
Height*	153-243 cm (60-96 in.)	153-243 cm (60-96 in.)
Weight	113 kg (lbs 248)	128 kg (lbs 282)

## Minimum operational space requirements

	Planmeca ProMax 2D	Planmeca ProMax 2D with cephalostat
Width	150 cm (59 in.)	215 cm (85 in.)
Depth	163 cm (64 in.)	163 cm (64 in.)
Height*	243 cm (96 in.)	243 cm (96 in.)

\*The maximum height of the unit can be adjusted for offices with limited ceiling space.

## Stand out with colour





# Technical specifications

## Technical data

Generator	Constant potential, resonance mode high frequency 60–80 kHz
X-ray tube	D-058SBR
Focal spot size	0.5 x 0.5 mm (IEC 336)
SID	480 mm (19 in.)
Total filtration	min. 2.5 mm Al eq.
Anode voltage	60–70 kV
Anode current	2–7 mA DC
Exposure time	2–10 s
Line voltage	100–132 V– 50/60 Hz, 180–240 V– 50 Hz
Regulation	±10 % (automatic)
Line current	8–16 A
Power uptake	max: 850 W
Chin rest level	95–178 cm (37.4–70 in.)
Colour	White (RAL 9016)
Weight	67 kg (148 lbs)

## Imaging programs

<b>Standard:</b> Basic panoramic programs	Standard panoramic Lateral TMJ PA TMJ PA Sinus
<b>Standard</b>	Child (Paediatric) mode for each program to reduce the dose
<b>Optional</b>	Horizontal and vertical segmenting for panoramic program
<b>Optional</b>	Bitewing
<b>Optional:</b> Advanced panoramic programs	Interproximal panoramic Orthogonal (perio) panoramic Lateral-PA TMJ Lateral multiangle TMJ Lateral non rotational sinus Cross-sections Bitewing

## Physical space requirements

Width	Depth	Height
97 cm	103 cm	223 cm
38 in.	41 in.	88 in.

## Dimensions

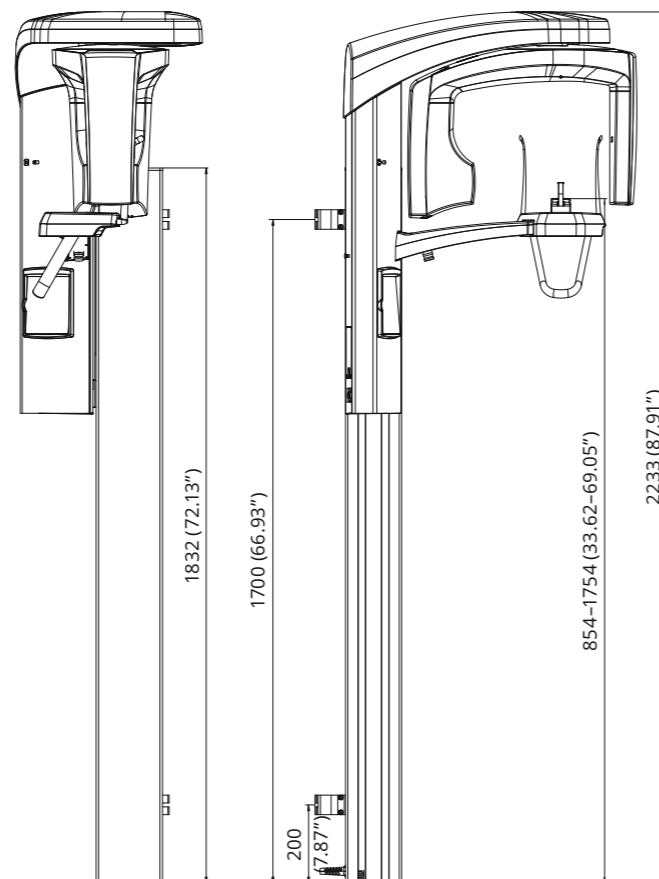
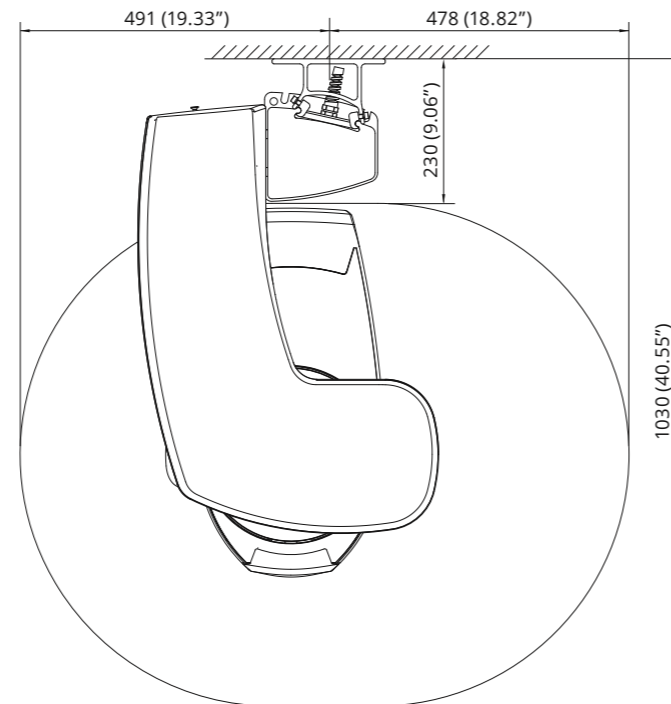

# Technical specifications

## Technical data

Generator	Constant potential, microprocessor controlled, operating frequency 66 kHz
X-ray tube	Toshiba D-041SB
Focal spot size	0.4 mm according to IEC 60336
Cone diameter	60 mm (2.36 in.) Rectangular 36 x 45 mm (1.42 x 1.77 in.)
Max. symmetrical radiation field	Ø60 mm at SSD 200 mm Ø60 mm at SSD 300 mm according to IEC 806
Total filtration	min. 2.5 mm Al equivalent at 70 kV according to IEC 60522
Inherent filtration	1 mm Al equivalent at 70 kV according to IEC 60522
Anode voltage	60, 63, 66, 70 kV
Anode current	8, 7, 6, 5, 4, 3, 2 mA
Exposure times	0.01–2 sec., 24 steps
SSD (Source-Skin Distance) Standard/Long	200 mm (8 in.)/300 mm (12 in.)
Mains voltage	100 V~/110-115 V~/220-240 V~, 50/60 Hz
Duty cycle	1:13.5
Electrical classification	Class I Type B
Weight	total 29 kg (64 lbs) tube head with standard cone 4.2 kg (9.3 lbs) tube head with long cone 4.5 kg (10 lbs)
Colour	White (RAL 9016)

## Dimensions

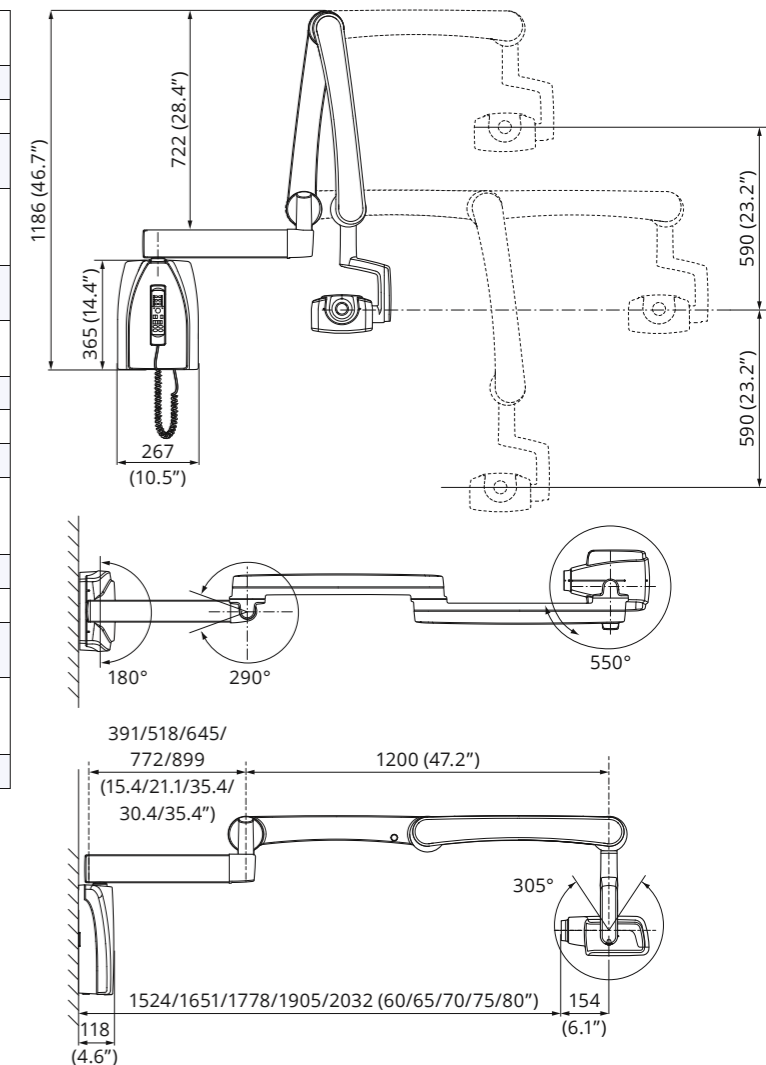

## Installation options

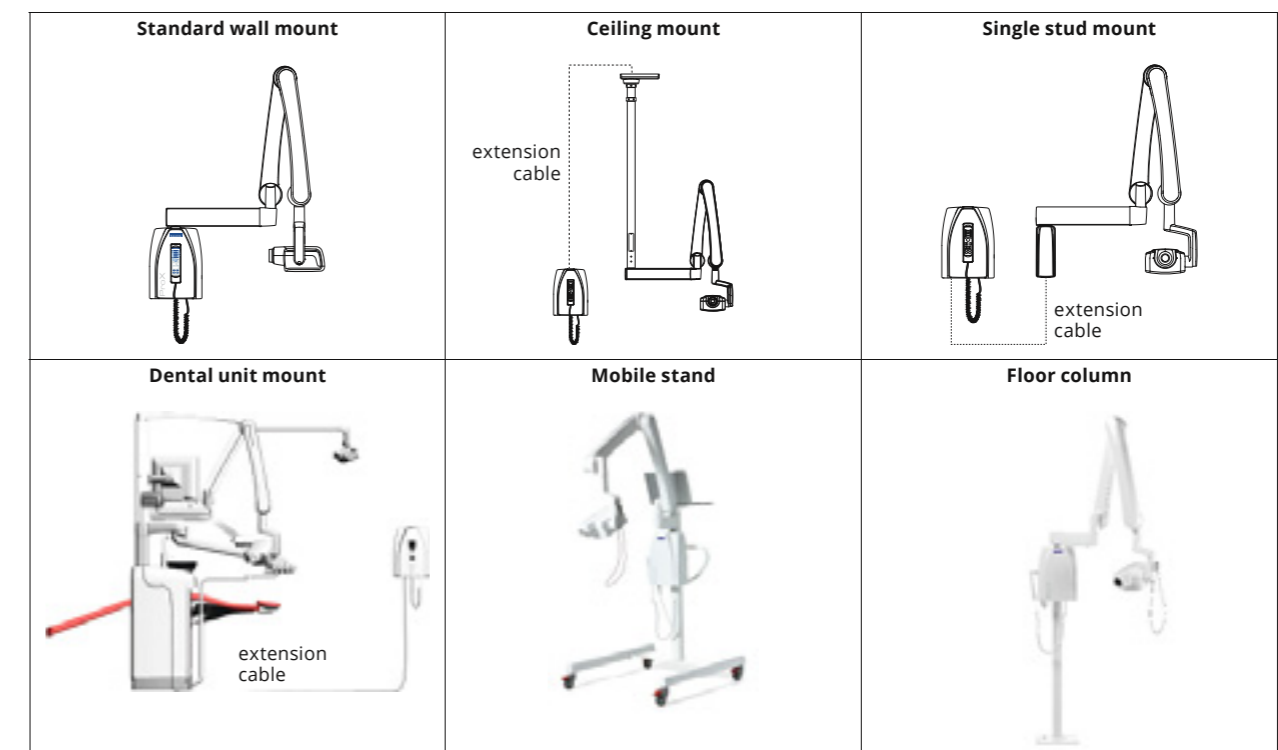

# Technical specifications

## Technical data for Planmeca ProSensor® HD

	Size 0	Size 1	Size 2
Sensor size	33.6 x 23.4 mm (1.33 x 0.92 in.)	39.7 x 25.1 mm (1.56 x 0.99 in.)	44.1 x 30.4 mm (1.76 x 1.2 in.)
Active area	25.5 x 18.9 mm (1.0 x 0.74 in.)	30.6 x 20.7 mm (1.20 x 0.81 in.)	36 x 26.1 mm (1.42 x 1.03 in.)
Number of pixels, normal	850 x 629 px	1020 x 690 px	1200 x 870 px
Number of pixels, high	-	2040 x 1380 px	2400 x 1740 px
Pixel size, normal	30 µm x 30 µm		
Pixel size, high	15 µm x 15 µm		
Theoretical resolution	33 lp/mm		
Resolution, normal	17 lp/mm		
Resolution, high	>20 lp/mm		
Interface	USB or Ethernet		
View delay	<5 sec.		

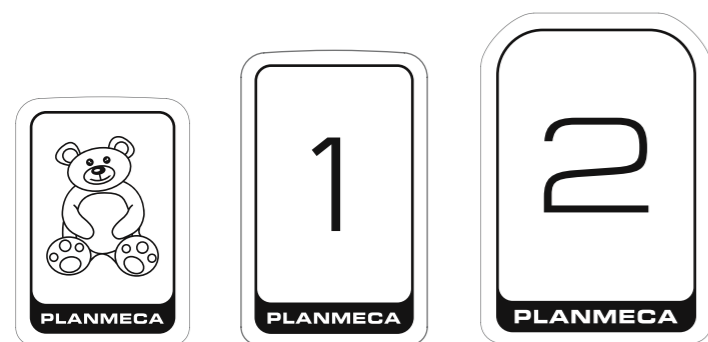

## Technical data for Planmeca ProScanner®

	0	1	2	3	4c
Imaging plate size	22 x 31 mm (0.87 x 1.22 in.)	24 x 40 mm (0.94 x 1.57 in.)	31 x 41 mm (1.22 x 1.61 in.)	27 x 54 mm (1.06 x 2.13 in.)	48 x 54 mm (1.89 x 2.13 in.)
Number of pixels, standard	343 x 484 px	375 x 625 px	484 x 640 px	421 x 843 px	750 x 843 px
Number of pixels, high	628 x 885 px	685 x 1143 px	886 x 1171 px	771 x 1542 px	1370 x 1542 px
Pixel size, standard	64 µm				
Pixel size, high	35 µm				
Readout time	4.1 – 7.2 sec				
Theoretical resolution	14.3 lp/mm				
Eraser	Embedded				
Dimensions (H x W x D)	265 x 120 x 318 mm (10.4 x 4.7 x 12.5 in.)				
Weight	5.5 kg (12.1 lbs)				
System configuration	Tabletop				
Interface	USB 2.0 high speed (480 Mbps) / Ethernet (100 Mbps)				

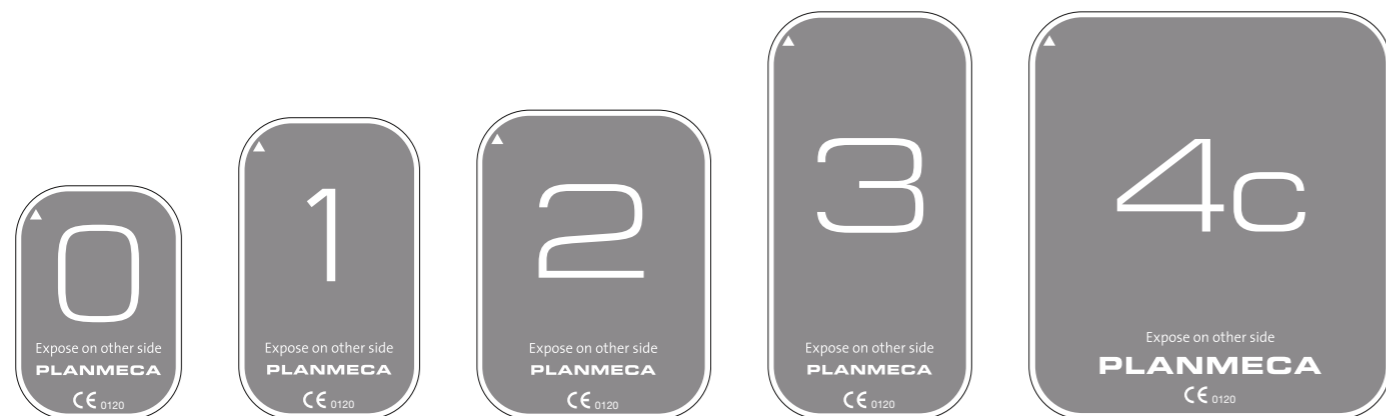

# Technical specifications

Supported 2D modalities	Intraoral Panoramic Cephalometric 2D linear tomography Photos Stack images (CBCT slices and panoramic slices)
Supported 3D modalities	3D CBCT 3D photo 3D surface scan
Supported photo sources	Intraoral camera Digital camera or scanner (import or TWAIN capture)
Operating systems	Win 7 Pro / Win 8.1 Pro / Win 10 (64 bit) Win 2008 Server / Win 2012 Server Mac* (OS X or newer)  For detailed information please see system requirements of Planmeca Romexis <a href="http://www.planmeca.com">www.planmeca.com</a>  *Cephalometric Analysis module, 3D Ortho Studio module and Planmeca PlanCAD Easy are supported on Windows operating systems.
Image formats	JPEG or TIFF (2D image) DICOM (2D and 3D image) STL (3D image) TIFF, JPEG, PNG, BMP (import/export)
Image size	2D X-ray image: 1–9 MB 3D X-ray image: typically 50 MB–1 GB
Installation options	Client-Server Java Web Start deployment
DICOM 3.0 support	DICOM Import/Export DICOM DIR Media Storage DICOM Print SCU DICOM Storage SCU DICOM Worklist SCU DICOM Query/Retrieve DICOM Storage Commitment DICOM MPPS
Interfaces	TWAIN Client PMBridge (patient information and images) VDDS (patient information and images) InfoCarrier (patient information) Datagate (patient and user information)
3 <sup>rd</sup> party software integrations	Dolphin Imaging Nobel Clinician Materialise Dental Simplant Straumann coDiagnostiX Cybermed N-Liten

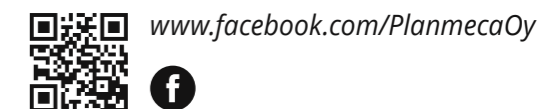

One software for all.



*Planmeca Oy designs and manufactures a full line of industry-leading dental equipment, including 3D and 2D imaging devices, CAD/CAM solutions, dental care units and software. Planmeca Oy, the parent company of the Finnish Planmeca Group, is strongly committed to better care through innovation, and it is the largest privately held company in the field.*

# PLANMECA

Asentajankatu 6 | 00880 Helsinki | Finland | tel. +358 20 7795 500 | fax +358 20 7795 555 | sales@planmeca.com | www.planmeca.com

Images may contain optional items not included in standard delivery. Available configurations and features may have country or area specific variations. Some products displayed above may not be available in all countries or areas. Rights for changes reserved.

Planmeca, All in one, Anatomat Plus, Cobra, Comfy, DentreVac, Digital perfection, Economat Plus, Elegant, Flexy, Mini-dent, Perio Fresh, PlanEasyMill, Planmeca 4D, Planmeca AINO, Planmeca ARA, Planmeca CAD/CAM, Planmeca CALM, Planmeca Chair, Planmeca Clarify, Planmeca Compact, Planmeca Creo, Planmeca Emerald, Planmeca FIT, Planmeca Intra, Planmeca iRomexis, Planmeca Lumion, Planmeca Lumo, Planmeca Maximity, Planmeca Minea, Planmeca Minendo, Planmeca Minetto, Planmeca mRomexis, Planmeca Noma, Planmeca Olo, Planmeca Online, Planmeca PlanCAD, Planmeca PlanCAM, Planmeca PlanClear, Planmeca PlanID, Planmeca PlanMill, Planmeca Planosil, Planmeca PlanPure, Planmeca PlanScan, Planmeca PlanView, Planmeca ProCeph, Planmeca ProFace, Planmeca ProID, Planmeca ProMax, Planmeca ProModel, Planmeca ProOne, Planmeca ProScanner, Planmeca ProSensor, Planmeca ProX, Planmeca Romexis, Planmeca Serenus, Planmeca SingLED, Planmeca SmartGUI, Planmeca Solea, Planmeca Sovereign, Planmeca Ultra Low Dose, Planmeca Vision, Planmeca Viso, Planmeca Verity, Planmeca Waterline Cleaning System, Planmeca Xtremity, Proline Dental Stool, ProTouch, Saddle Stool, SmartPan, SmartTouch, Trendy, and Ultra Relax are registered or non-registered trademarks of Planmeca in various countries.

10032800/0517/en

