

Techn. Daten: Oriental 3

Log length (W x D): 380 x 260 cm

Wall size(outside): 370 x 250 cm · Log thickness: 28 mm

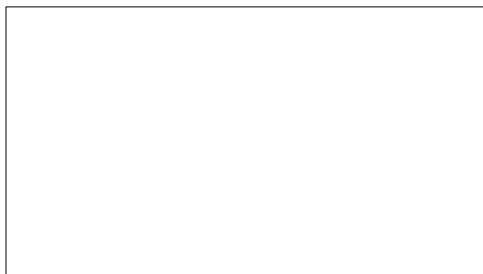
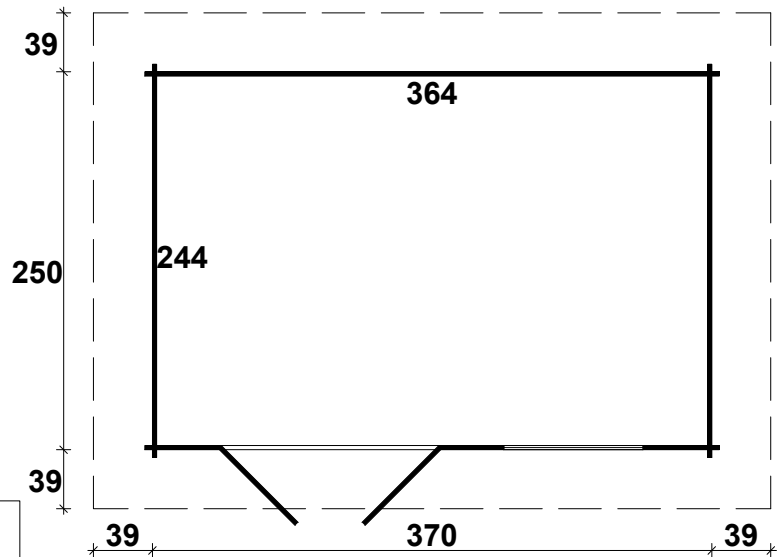

Note: All dimensions are approximate !

Foundation plan - Oriental 3

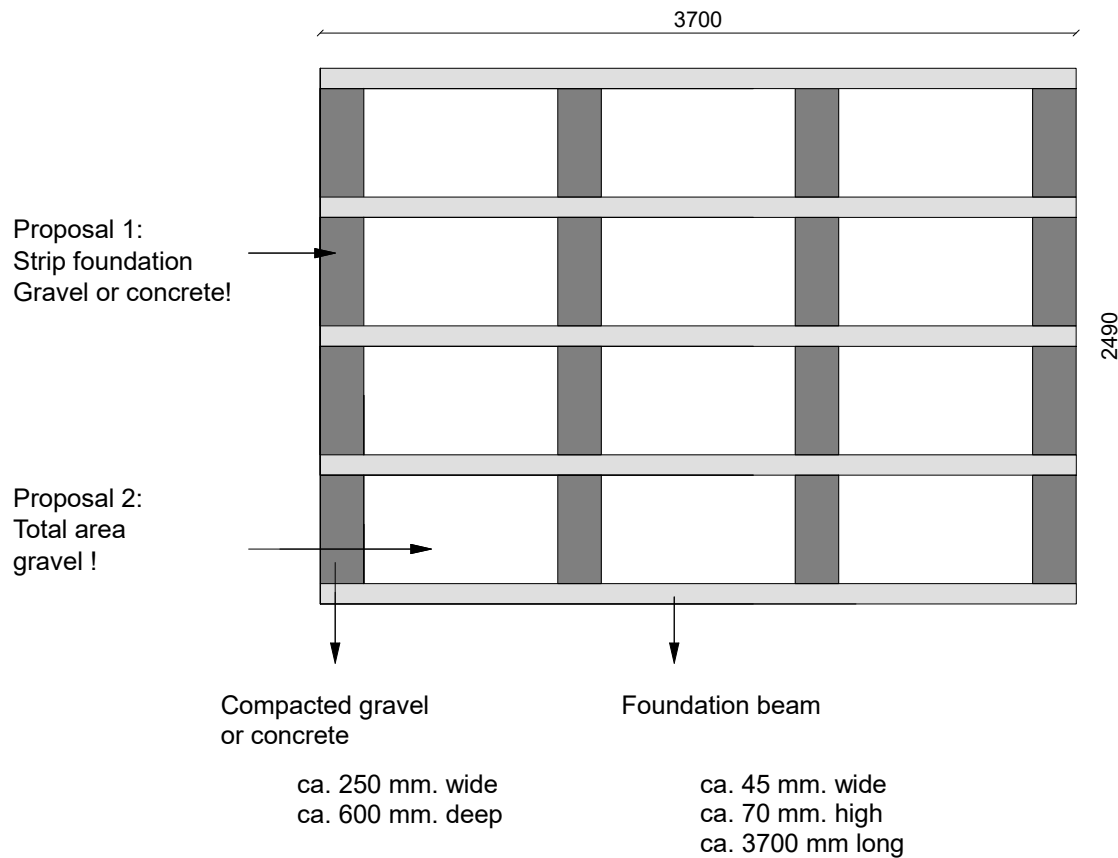
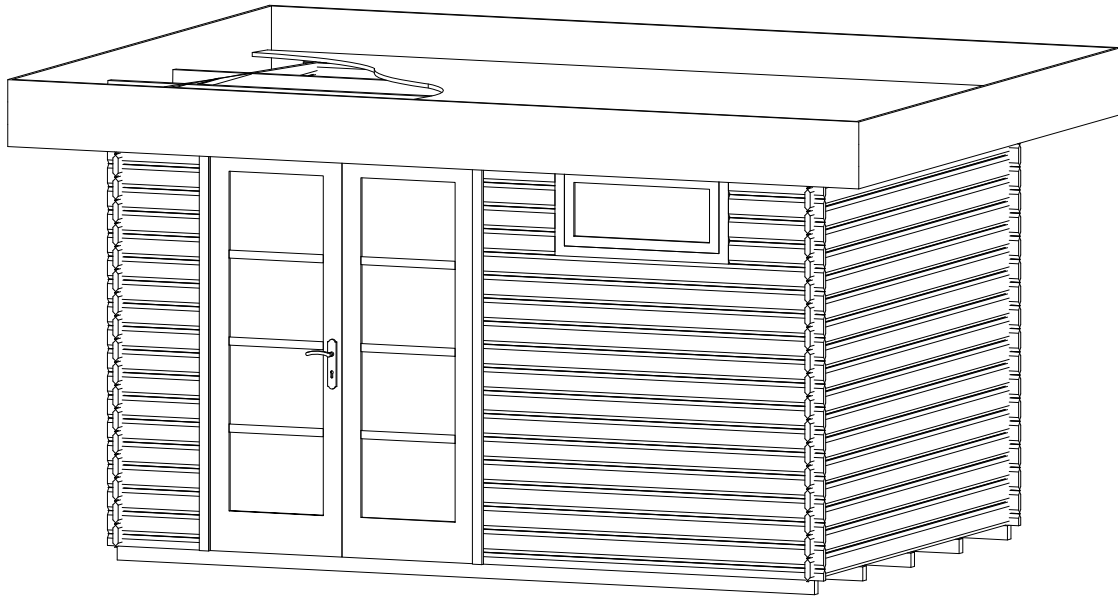

House	Number of foundation beams
Oriental 3	5(circa 45x70x3700 mm)

Detailed views - Oriental 3

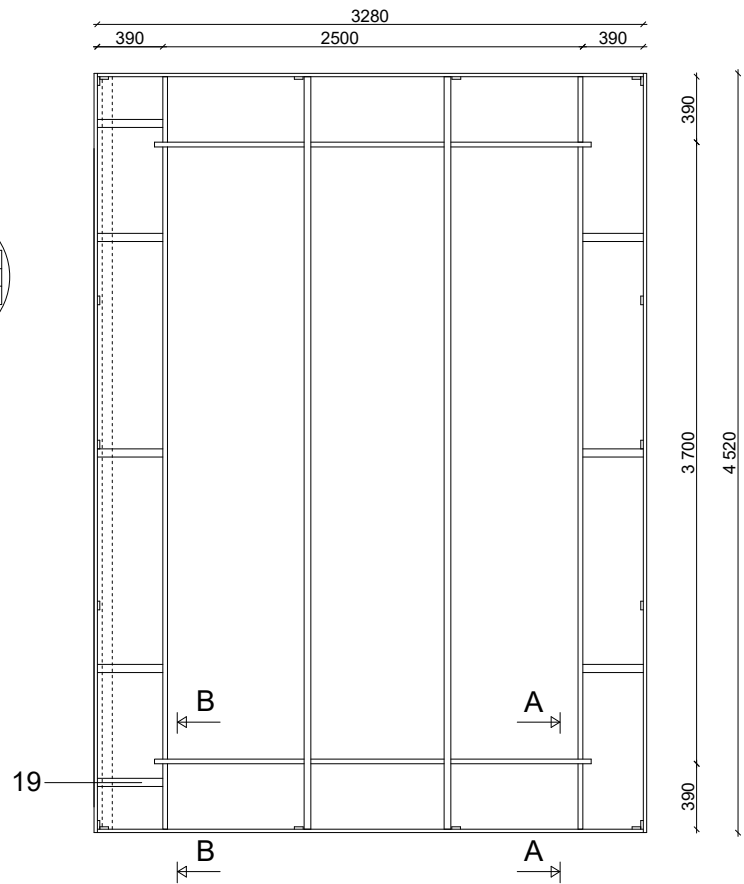
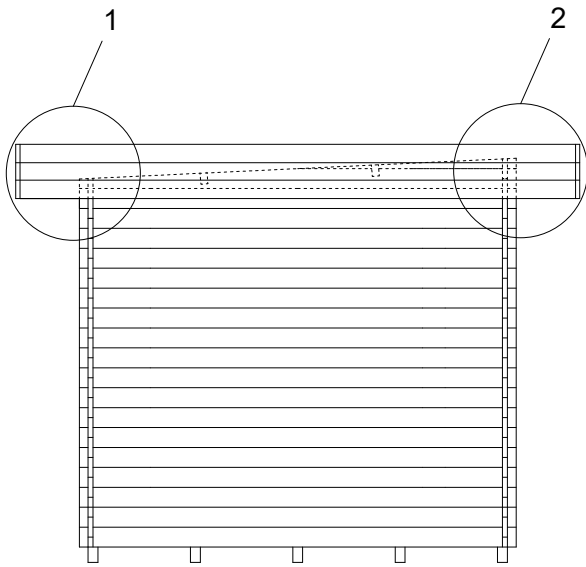

1

2

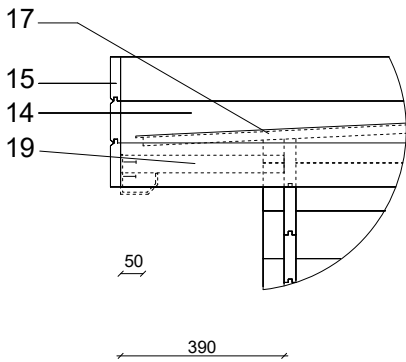

A-A

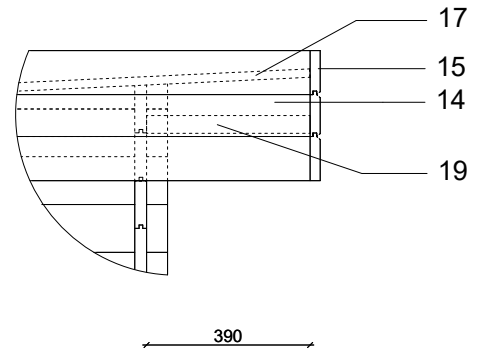



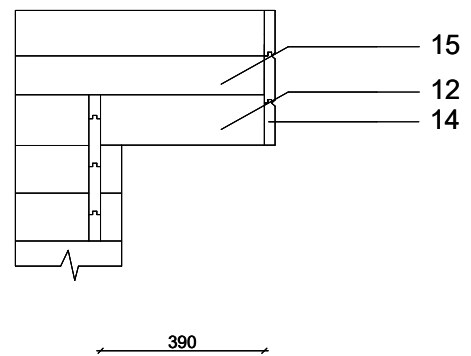
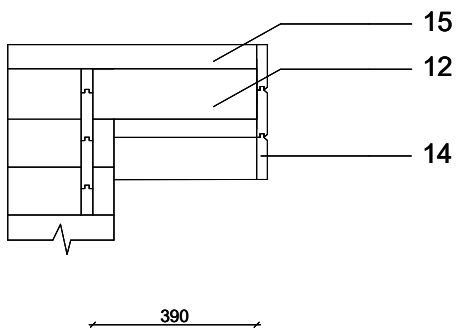



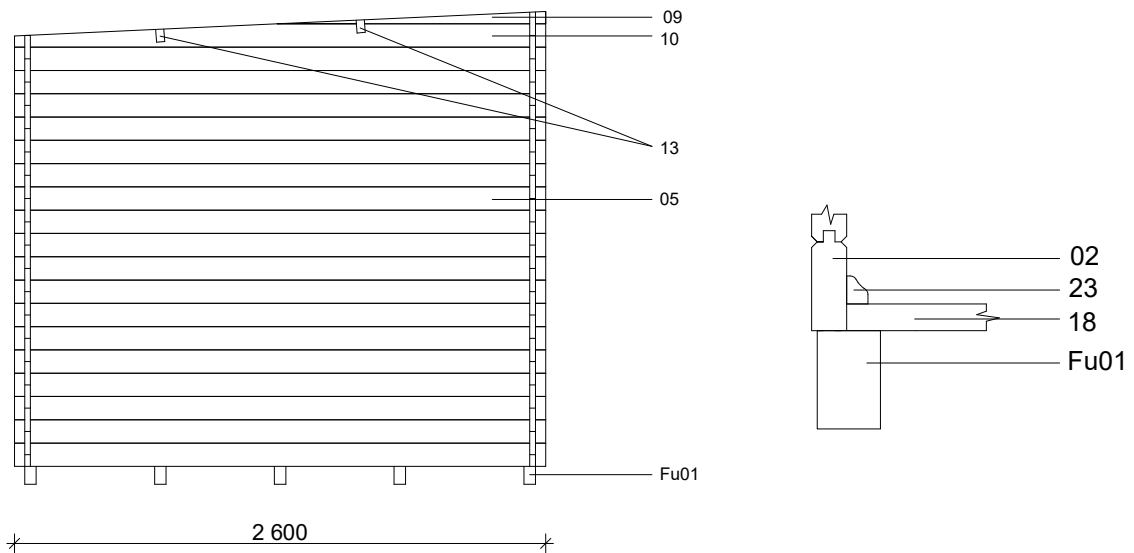
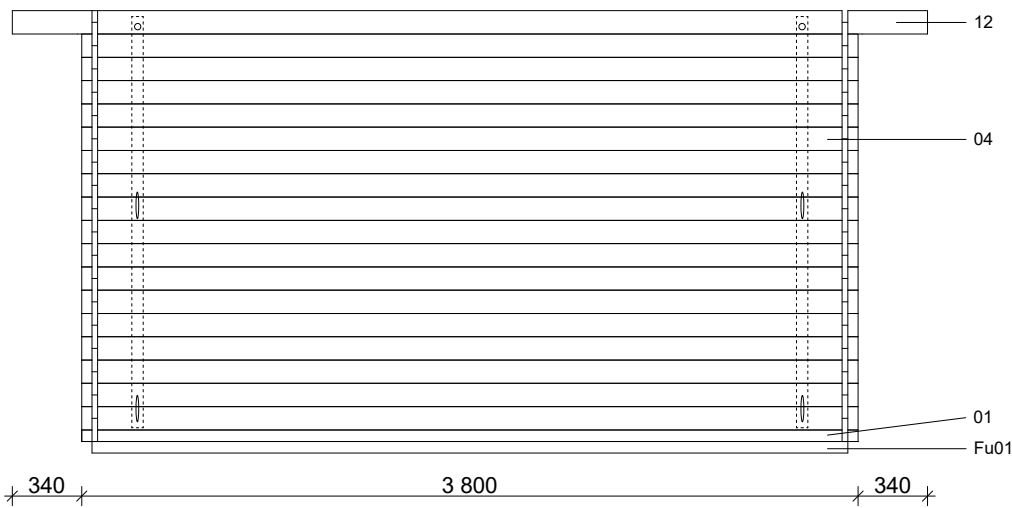
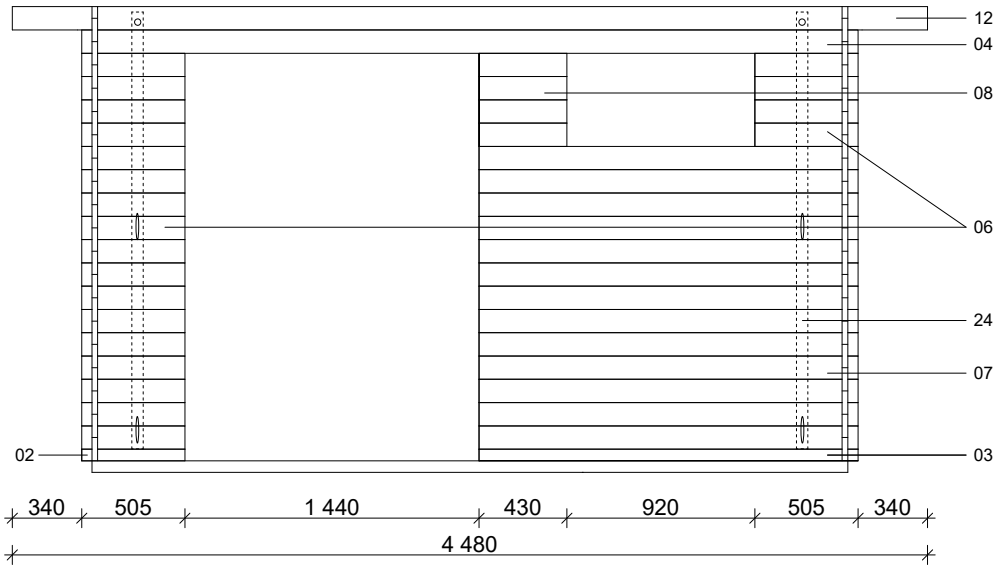







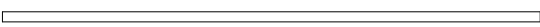





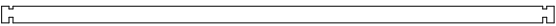











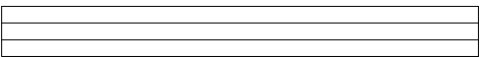
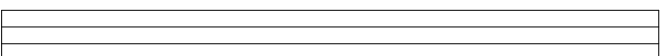

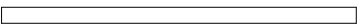

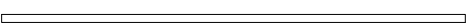





B-B



Wall plan - Oriental 3

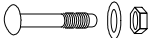

Specification Oriental 3

Nr.		 mm	 mm	 x	
Fu01	Foundation beams 	 45x70	3700	5	
01		 28x57	3800	1	
02			505	1	
03			1855	1	
04			 28x114	3800	18
05				2600	36
06				505	21
07				1855	13
08				430	4
09				1200	2
10				2600	2
12			 28x114	4480	2
13			 40x143	4480	2
14				3280	2
15			4520	2	
17	Roof board / Dachbretter 	 18x110	3230	41+1	
18	Floor board / Fußbodenbretter 		2440	34+1	
19		 45x70	390	8	
22		 28x55	3190	2	
			4480	1	
23	Baseboard / Fußleisten		ca. 13,0 m		
24	Storm braces / Sturmleisten 	 20x38	2150	2	
	Storm braces / Sturmleisten 		2010	2	
25	Screws / Schrauben 		4,0 x 40	20	
	Screws / Schrauben 		4,0 x 50	370	
	Screws / Schrauben 		5,0 x 70	60	
	Screws / Schrauben 		6,0 x 140	40	
	Nails / Nägel 		1,4 x 35	50	
29	M 8 x 60, Nut , Washer 			12	
31	Hit block / Schlaghölzer 			3	
20	Double door /Doppeltür ca. 1425 x1955 mm			1	
21	Window /Einzelfenster ca. 915x420mm			1	